

SIEMENS

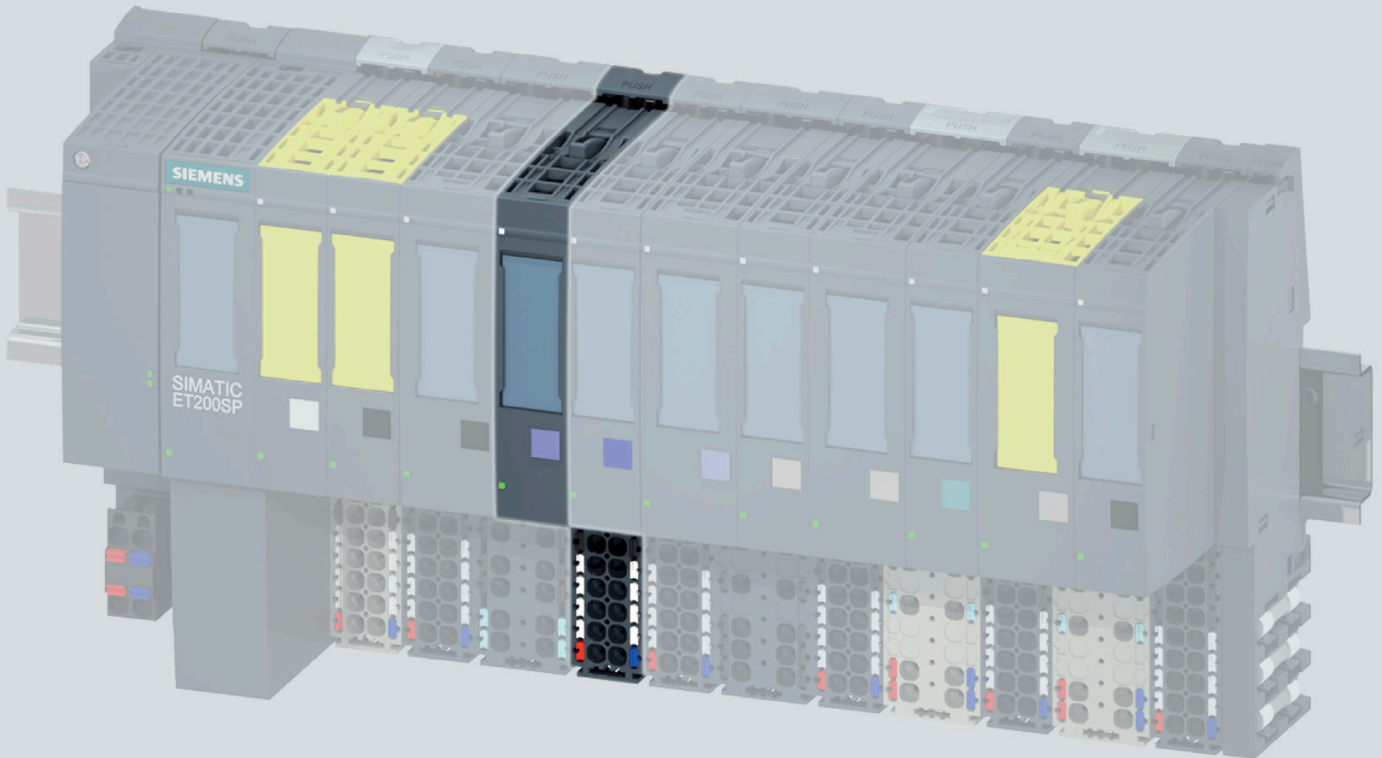

Manual

SIMATIC

ET 200SP

Analog input module
AI 4xI 2-/4-wire ST (6ES7134-6GD01-0BA1)

Edition

06/2020

support.industry.siemens.com

SIEMENS

SIMATIC

ET 200SP

Analog Input Module AI 4xI 2-/4-wire ST

(6ES7134-6GD01-0BA1)

Equipment Manual

Preface

Documentation guide

1

Product overview

2

Wiring up

3

Parameters/address space

4

Interrupts/diagnostics alarms

5

Technical specifications

6

Parameter data record

A



Representation of analog
values

B

Legal information

Warning notice system

This manual contains notices you have to observe in order to ensure your personal safety, as well as to prevent damage to property. The notices referring to your personal safety are highlighted in the manual by a safety alert symbol, notices referring only to property damage have no safety alert symbol. These notices shown below are graded according to the degree of danger.

 DANGER
indicates that death or severe personal injury will result if proper precautions are not taken.
 WARNING
indicates that death or severe personal injury may result if proper precautions are not taken.
 CAUTION
indicates that minor personal injury can result if proper precautions are not taken.
NOTICE
indicates that property damage can result if proper precautions are not taken.

If more than one degree of danger is present, the warning notice representing the highest degree of danger will be used. A notice warning of injury to persons with a safety alert symbol may also include a warning relating to property damage.

Qualified Personnel

The product/system described in this documentation may be operated only by **personnel qualified** for the specific task in accordance with the relevant documentation, in particular its warning notices and safety instructions. Qualified personnel are those who, based on their training and experience, are capable of identifying risks and avoiding potential hazards when working with these products/systems.

Proper use of Siemens products

Note the following:

 WARNING
Siemens products may only be used for the applications described in the catalog and in the relevant technical documentation. If products and components from other manufacturers are used, these must be recommended or approved by Siemens. Proper transport, storage, installation, assembly, commissioning, operation and maintenance are required to ensure that the products operate safely and without any problems. The permissible ambient conditions must be complied with. The information in the relevant documentation must be observed.

Trademarks

All names identified by ® are registered trademarks of Siemens AG. The remaining trademarks in this publication may be trademarks whose use by third parties for their own purposes could violate the rights of the owner.

Disclaimer of Liability

We have reviewed the contents of this publication to ensure consistency with the hardware and software described. Since variance cannot be precluded entirely, we cannot guarantee full consistency. However, the information in this publication is reviewed regularly and any necessary corrections are included in subsequent editions.

Preface

Purpose of the documentation

This manual supplements the system manual ET 200SP distributed I/O system (<http://support.automation.siemens.com/WW/view/en/58649293>).

Functions that generally relate to the system are described in this manual.

The information provided in this manual and in the system/function manuals supports you in commissioning the system.

Changes compared to previous version

Compared to the previous version, this manual contains the following change:

Wiring and block diagram has been modified.

Conventions

CPU: When the term "CPU" is used in the following, it applies to the CPUs of the S7-1500 automation system as well as to the CPUs/interface modules of the ET 200SP distributed I/O system.

STEP 7: In this documentation, "STEP 7" is used as a synonym for all versions of the configuration and programming software "STEP 7 (TIA Portal)".

Please also observe notes marked as follows:

Note

A note contains important information on the product described in the documentation, on the handling of the product or on the section of the documentation to which particular attention should be paid.

Siemens provides products and solutions with industrial security functions that support the secure operation of plants, systems, machines and networks.

In order to protect plants, systems, machines and networks against cyber threats, it is necessary to implement – and continuously maintain – a holistic, state-of-the-art industrial security concept. Siemens' products and solutions constitute one element of such a concept.

Customers are responsible for preventing unauthorized access to their plants, systems, machines and networks. Such systems, machines and components should only be connected to an enterprise network or the internet if and to the extent such a connection is necessary and only when appropriate security measures (e.g. firewalls and/or network segmentation) are in place.

For additional information on industrial security measures that may be implemented, please visit (<https://www.siemens.com/industrialsecurity>).

Siemens' products and solutions undergo continuous development to make them more secure. Siemens strongly recommends that product updates are applied as soon as they are available and that the latest product versions are used. Use of product versions that are no longer supported, and failure to apply the latest updates may increase customers' exposure to cyber threats.

To stay informed about product updates, subscribe to the Siemens Industrial Security RSS Feed visit (<https://www.siemens.com/industrialsecurity>).

Table of contents

	Preface	3
1	Documentation guide	6
2	Product overview	11
	2.1 Properties.....	11
3	Wiring up	14
	3.1 Wiring and block diagram	14
4	Parameters/address space	17
	4.1 Measuring types and ranges	17
	4.2 Parameters	17
	4.3 Explanation of the parameters.....	20
	4.4 Address space	22
5	Interrupts/diagnostics alarms.....	23
	5.1 Status and error display.....	23
	5.2 Interrupts.....	25
	5.3 Diagnostics alarms.....	25
6	Technical specifications	27
	6.1 Technical specifications	27
A	Parameter data record	32
	A.1 Dependencies when configuring with GSD file.....	32
	A.2 Parameter assignment and structure of the parameter data record.....	33
	A.3 Error in transferring the data record analog input.....	37
B	Representation of analog values	38
	B.1 Representation of input ranges.....	39
	B.2 Representation of analog values in the current measuring ranges	40

Documentation guide

The documentation for the SIMATIC ET 200SP distributed I/O system is arranged into three areas.

This arrangement enables you to access the specific content you require.

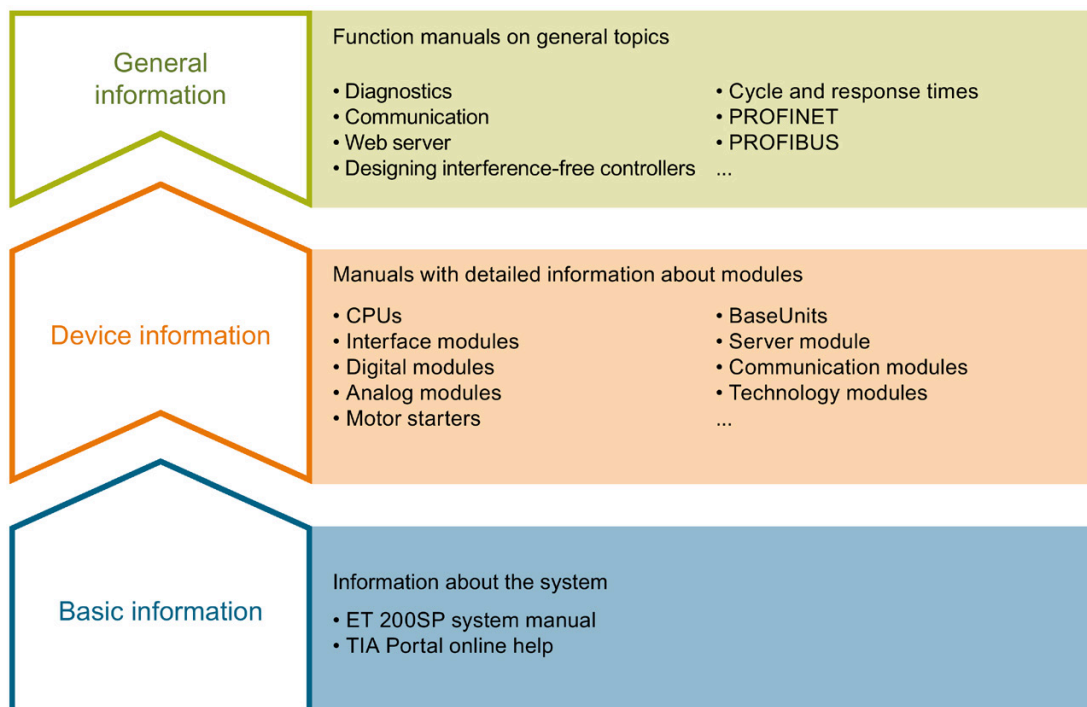

Basic information

The System Manual and Getting Started describe in detail the configuration, installation, wiring and commissioning of the SIMATIC ET 200SP distributed I/O system. The STEP 7 online help supports you in the configuration and programming.

Device information

Product manuals contain a compact description of the module-specific information, such as properties, wiring diagrams, characteristics and technical specifications.

General information

The function manuals contain detailed descriptions on general topics regarding the SIMATIC ET 200SP distributed I/O system, e.g. diagnostics, communication, Web server, motion control and OPC UA.

You can download the documentation free of charge from the Internet (<https://support.industry.siemens.com/cs/ww/en/view/109742709>).

Changes and supplements to the manuals are documented in a Product Information.

You can download the product information free of charge from the Internet (<https://support.industry.siemens.com/cs/us/en/view/73021864>).

Manual Collection ET 200SP

The Manual Collection contains the complete documentation on the SIMATIC ET 200SP distributed I/O system gathered together in one file.

You can find the Manual Collection on the Internet (<https://support.automation.siemens.com/WWW/view/en/84133942>).

"mySupport"

With "mySupport", your personal workspace, you make the best out of your Industry Online Support.

In "mySupport", you can save filters, favorites and tags, request CAx data and compile your personal library in the Documentation area. In addition, your data is already filled out in support requests and you can get an overview of your current requests at any time.

You must register once to use the full functionality of "mySupport".

You can find "mySupport" on the Internet (<https://support.industry.siemens.com/My/ww/en>).

"mySupport" - Documentation

With "mySupport", your personal workspace, you make the best out of your Industry Online Support.

In "mySupport", you can save filters, favorites and tags, request CAx data and compile your personal library in the Documentation area. In addition, your data is already filled out in support requests and you can get an overview of your current requests at any time.

You must register once to use the full functionality of "mySupport".

You can find "mySupport" on the Internet (<https://support.industry.siemens.com/My/ww/en/documentation>).

"mySupport" - CAx data

In the CAx data area of "mySupport", you can access the latest product data for your CAx or CAe system.

You configure your own download package with a few clicks.

In doing so you can select:

- Product images, 2D dimension drawings, 3D models, internal circuit diagrams, EPLAN macro files
- Manuals, characteristics, operating manuals, certificates
- Product master data

You can find "mySupport" - CAx data on the Internet (<https://support.industry.siemens.com/my/ww/en/CAxOnline>).

Application examples

The application examples support you with various tools and examples for solving your automation tasks. Solutions are shown in interplay with multiple components in the system - separated from the focus on individual products.

You will find the application examples on the Internet (<https://support.industry.siemens.com/sc/ww/en/sc/2054>).

TIA Selection Tool

With the TIA Selection Tool, you can select, configure and order devices for Totally Integrated Automation (TIA).

This tool is the successor of the SIMATIC Selection Tool and combines the known configurators for automation technology into one tool.

With the TIA Selection Tool, you can generate a complete order list from your product selection or product configuration.

You can find the TIA Selection Tool on the Internet (<https://new.siemens.com/global/en/productservices/automation/topics/tia/tia-selection-tool.html>).

SIMATIC Automation Tool

You can use the SIMATIC Automation Tool to perform commissioning and maintenance activities simultaneously on various SIMATIC S7 stations as a bulk operation independent of TIA Portal.

The SIMATIC Automation Tool provides a multitude of functions:

- Scanning of a PROFINET/Ethernet system network and identification of all connected CPUs
- Address assignment (IP, subnet, gateway) and station name (PROFINET device) to a CPU
- Transfer of the date and the programming device/PC time converted to UTC time to the module
- Program download to CPU
- RUN/STOP mode switchover
- CPU localization by means of LED flashing
- Reading out of CPU error information
- Reading of the CPU diagnostics buffer
- Reset to factory settings
- Firmware update of the CPU and connected modules

You can find the SIMATIC Automation Tool on the Internet (<https://support.industry.siemens.com/cs/ww/en/view/98161300>).

PRONETA

SIEMENS PRONETA (PROFINET network analysis) allows you to analyze the plant network during commissioning. PRONETA features two core functions:

- The topology overview automatically scans the PROFINET and all connected components.
- The IO check is a fast test of the wiring and the module configuration of a plant.

You can find SIEMENS PRONETA on the Internet (<https://support.industry.siemens.com/cs/ww/en/view/67460624>).

SINETPLAN

SINETPLAN, the Siemens Network Planner, supports you in planning automation systems and networks based on PROFINET. The tool facilitates professional and predictive dimensioning of your PROFINET installation as early as in the planning stage. In addition, SINETPLAN supports you during network optimization and helps you to exploit network resources optimally and to plan reserves. This helps to prevent problems in commissioning or failures during productive operation even in advance of a planned operation. This increases the availability of the production plant and helps improve operational safety.

The advantages at a glance

- Network optimization thanks to port-specific calculation of the network load
- Increased production availability thanks to online scan and verification of existing systems
- Transparency before commissioning through importing and simulation of existing STEP 7 projects
- Efficiency through securing existing investments in the long term and the optimal use of resources

You can find SINETPLAN on the Internet (<https://www.siemens.com/sinetplan>).

Product overview

2.1 Properties

Article number

6ES7134-6GD01-0BA1 (number in pack: 1 unit)

6ES7134-6GD01-2BA1 (number in pack: 10 units)

View of the module

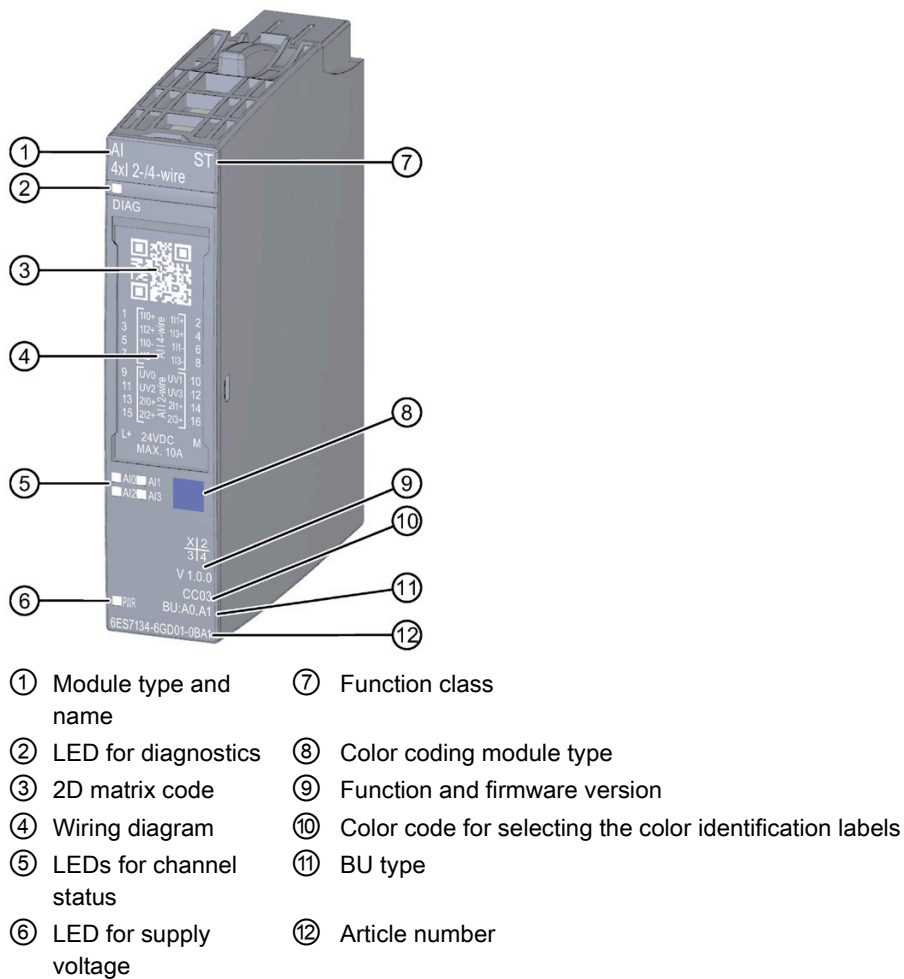

Figure 2-1 View of the module AI 4x1 2-/4-wire ST

Properties

The module has the following technical properties:

- Analog input module with 4 inputs
- Current measuring type for 2- and 4-wire transducers adjustable per channel
- Input ranges
 - 4 to 20 mA, resolution 15 bits
 - 0 to 20 mA, resolution 15 bits
 - ± 20 mA, resolution 16 bits including sign
- Electrically isolated from the supply voltage L+ (only for input type 4-wire transducer)
- Permitted common mode voltage: 10 V_{SS}
- Configurable diagnostics per module

The module supports the following functions:

Table 2- 1 Version dependencies of the functions

Function	HW version	FW version	STEP 7		GSD file	
			TIA Portal	V5.x	PROFINET IO	PROFIBUS DP
Firmware update	FS01	V2.0.0	V14 or higher with HSP 0239	V5.5 SP3 or higher with HSP 0227 V7.0 or higher	X	X
Identification data I&M0 to I&M3	FS01	V2.0.0	V14 or higher with HSP 0239	V5.5 SP3 or higher with HSP 0227 V7.0 or higher	X	X
Reconfiguration in RUN	FS01	V2.0.0	V14 or higher with HSP 0239	V5.5 SP3 or higher with HSP 0227 V7.0 or higher	X	X
PROFenergy	FS01	V2.0.0	V14 or higher with HSP 0239	V5.5 SP3 or higher with HSP 0227 V7.0 or higher	X	X
Value status	FS01	V2.0.0	V14 or higher with HSP 0239	V5.5 SP3 or higher with HSP 0227 V7.0 or higher	X	X

Accessories

The following accessories must be ordered separately:

- Labeling strips
- Color identification labels
- Reference identification label
- Shield connector

See also

You will find additional information on the accessories in the ET 200SP distributed I/O system (<https://support.industry.siemens.com/cs/ww/en/view/58649293>) system manual.

Wiring up

3.1 Wiring and block diagram

This section includes the block diagram of the AI 4xI 2-/4-wire ST module with the various terminal assignments for a 2-wire and 4-wire connection.

You can find information on wiring the BaseUnit in the ET 200SP distributed I/O system (<http://support.automation.siemens.com/WW/view/en/58649293>) system manual.

Note

You can use and combine the different wiring options for all channels.

Note

The load group of the module must begin with a light BaseUnit. Keep this in mind also during the configuration.

Wiring: Current measurement 2-wire and 4-wire connection (2-wire and 4-wire transducer)

The following figure shows the block diagram and an example of the terminal assignment of the analog input module AI 4x1 2-/4-wire ST on the BaseUnit BU type A0/A1.

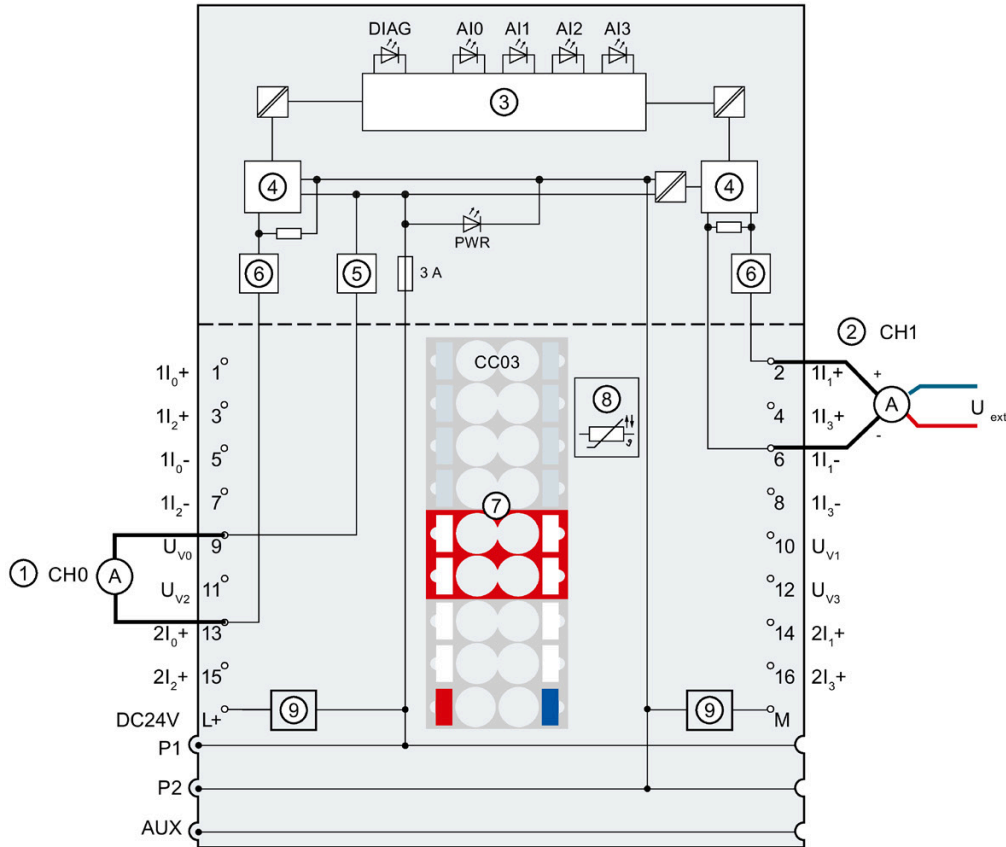

①	2-wire connection for current measurement (2-wire transducer)	1I _n +	Current input positive, channel n
②	4-wire connection for current measurement (4-wire transducer)	1I _n -	Current input negative, channel n
③	Backplane bus interface	U _{Vn}	Supply voltage, channel n
④	Analog-to-digital converter (ADC)	2I _n +	Current input positive, channel n
⑤	Short-circuit protection	L+	24 V DC (infeed only with light BaseUnit)
⑥	Current limitation	M	Ground
⑦	Color-coded label with color code CC03 (optional)	P1, P2, AUX	Internal self-assembling voltage buses Connection to left (dark BaseUnit) Connection to left interrupted (light BaseUnit)
⑧	Temperature recording for BU type A1 only (function cannot be used for this module)	DIAG	Diagnostics LED (green, red)
U _{ext}	Encoder supply external	AI0, AI1, AI2, AI3	Channel status LED (green)
		PWR	Power LED (green)

Figure 3-1 Wiring and block diagram for current measurement 2-wire and 4-wire connection (2- and 4-wire transducer)

Parameters/address space

4.1 Measuring types and ranges

The analog input module AI 4xI 2-/4-wire ST has the following measuring ranges:

Table 4- 1 Measuring ranges

Measuring type	Measuring range	Resolution
Current (2-wire transducer)	0 to 20 mA	15 bits
	4 to 20 mA	15 bits
Current (4-wire transducer)	0 to 20 mA	15 bits
	4 to 20 mA	15 bits
	± 20 mA	16 bits including sign

You will find the tables of the measuring ranges as well as overflow, overrange, etc., in the section Representation of analog values (Page 38).

4.2 Parameters

Parameters of the AI 4xI 2-/4-wire ST

Specify the module properties with the various parameters in the course of your STEP 7 configuration. The following table lists the configurable parameters. The effective range of the configurable parameters depends on the type of configuration. The following configurations are possible:

- Central operation with an ET 200SP CPU
- Distributed operation on PROFINET IO in an ET 200SP system
- Distributed operation with PROFIBUS DP in an ET 200SP system

When assigning parameters in the user program, use the "WRREC" instruction to transfer the parameters to the module using the data records; refer to the section Parameter assignment and structure of the parameter data record (Page 33).

4.2 Parameters

The following parameter settings are possible:

Table 4- 2 Configurable parameters and their defaults (GSD file)

Parameter	Value range	Default	Configura- tion in RUN	Scope with configuration soft- ware, e.g. STEP 7 (TIA Portal)	
				GSD file PROFINET IO	GSD file PROFIBUS DP
Diagnostics No supply voltage L+	<ul style="list-style-type: none"> • Disable • Enable 	Disable	Yes	Module	Module
Diagnostics Short-circuit to ground	<ul style="list-style-type: none"> • Disable • Enable 	Disable	Yes	Module	Module
Diagnostics Overflow	<ul style="list-style-type: none"> • Disable • Enable 	Disable	Yes	Module	Module
Diagnostics Underflow	<ul style="list-style-type: none"> • Disable • Enable 	Disable	Yes	Module	Module
Diagnostics Wire break	<ul style="list-style-type: none"> • Disable • Enable 	Disable	Yes	Module	Module
Measuring type/range	<ul style="list-style-type: none"> • deactivated • Current (4-wire transducer) 0..20 mA • Current (4-wire transducer) 4..20 mA • Current (4-wire transducer) +/-20 mA • Current (2-wire transducer) 0..20 mA • Current (2-wire transducer) 4..20 mA 	Current (4-wire transducer) 4..20 mA	Yes	Channel	Channel
Smoothing	<ul style="list-style-type: none"> • None • weak • medium • strong 	None	Yes	Channel	Channel

Parameter	Value range	Default	Configura- tion in RUN	Scope with configuration soft- ware, e.g. STEP 7 (TIA Portal)	
				GSD file PROFINET IO	GSD file PROFIBUS DP
Interference frequency suppression ²	<ul style="list-style-type: none"> 60 Hz 50 Hz¹ 16.6 Hz 	50 Hz	Yes	Channel	Module ³
Potential group	<ul style="list-style-type: none"> Use potential group of the left module (module plugged into a dark BaseUnit) Enable new potential group (module plugged into light BaseUnit) 	Use potential group of the left module	No	Module	Module

- ¹ Interference frequency suppression: Interfering signals at 400 Hz are automatically included in the filtering at 50 Hz.
- ² The settings in the "Interference frequency suppression" parameter have a direct effect on the conversion time of the channel. The analog value is therefore also affected by additionally set filtering via the "Smoothing" parameter.
- ³ Due to the limited number of parameters of a maximum of 244 bytes per ET 200SP station with a PROFIBUS GSD configuration, the parameter assignment options are restricted. The parameter length of the I/O module is 5 bytes with PROFIBUS GSD configuration. If necessary, you can set this parameter by using the data record 128, see the appendix "Parameter data set".

Note

Unused channels

"Disable" unused channels in the parameter assignment to improve the cycle time of the module.

A disabled channel always returns the value 7FFF_H.

4.3 Explanation of the parameters

Diagnostics no supply voltage L+

Enabling of the diagnostics for no or insufficient supply voltage L+.

Diagnostics Short-circuit to ground

Enabling of the diagnostics in the event of a short-circuit of the encoder supply to ground or of an input to the encoder supply.

Diagnostics overflow

Enabling of the diagnostics when the measured value exceeds the overrange.

Diagnostics underflow

Enabling of the diagnostics when the measured value falls below the underrange.

Diagnostics Wire break

Enabling of the diagnostics if the module has no current flow or the current is too weak to be measured at the relevant input.

The wire break and underflow diagnostics can be activated simultaneously. If both diagnostics events occur simultaneously, the wire break diagnostics info is output.

Type/range of measurement

See the section Measuring types and measuring ranges (Page 17).

Smoothing

The individual measured values are smoothed by filtering. The smoothing can be set in 4 levels.

Smoothing time = number of module cycles (k) x cycle time of the module.

The following figure shows how many module cycles it takes for the smoothed analog value to approach 100%, depending on the configured smoothing. This applies to every signal change at the analog input.

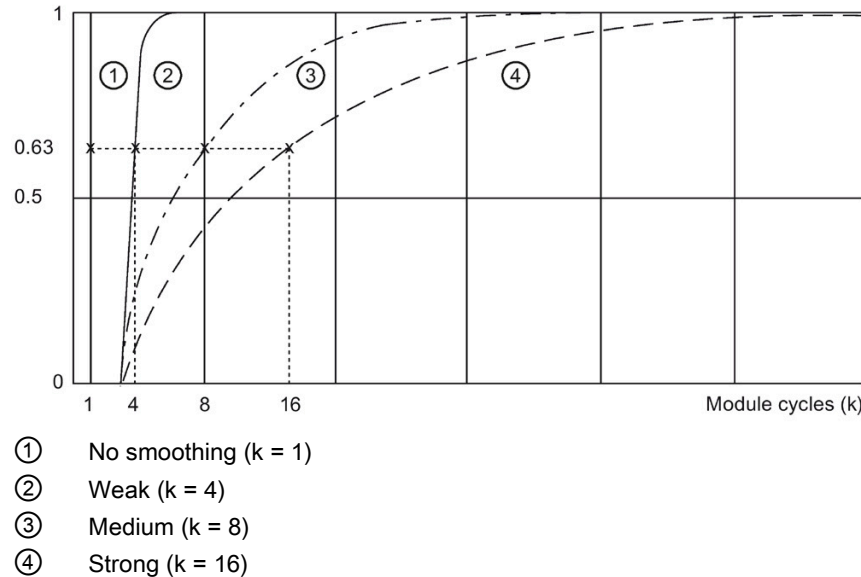

Figure 4-1 Smoothing with AI 4xI 2-/4-wire ST

Interference frequency suppression

Suppresses the interference affecting analog input modules that is caused by the frequency of the AC voltage network used.

The frequency of the AC voltage network can negatively affect the measured value, in particular when measuring in the low voltage range and with thermocouples. With this parameter, the user specifies the supply frequency that is predominant in the plant.

Potential group

A potential group consists of a group of directly adjacent I/O modules within an ET 200SP station, which are supplied via a common supply voltage.

A potential group begins with a light-colored BaseUnit through which the required voltage is supplied for all modules of the potential group. The light-colored BaseUnit interrupts the three self-assembling voltage buses P1, P2 and AUX to the left neighbor.

All additional I/O modules of this potential group are plugged into dark-colored BaseUnits. You take the potential of the self-assembling voltage buses P1, P2 and AUX from the left neighbor.

A potential group ends with the dark-colored BaseUnit, which follows a light-colored BaseUnit or server module in the station configuration.

4.4 Address space

Configuration options

The following configurations are possible:

- Configuration 1: Without value status
- Configuration 2: With value status

Evaluating the value status

If you enable the value status for the analog module, an additional byte is occupied in the input address space. Bits 0 to 3 in this byte are assigned to a channel. They provide information about the validity of the analog value.

Bit = 1: There are no faults/errors on the module.

Bit = 0: Channel is disabled or there is a fault/error on the module.

If a fault/error occurs on a channel with this module, the value status for all channels is 0.

Address space

The following figure shows the assignment of the address space for the AI 4xI 2-/4-wire ST with value status (Quality Information (QI)). The addresses for the value status are only available if the value status is enabled.

Assignment in the process image input (PII)

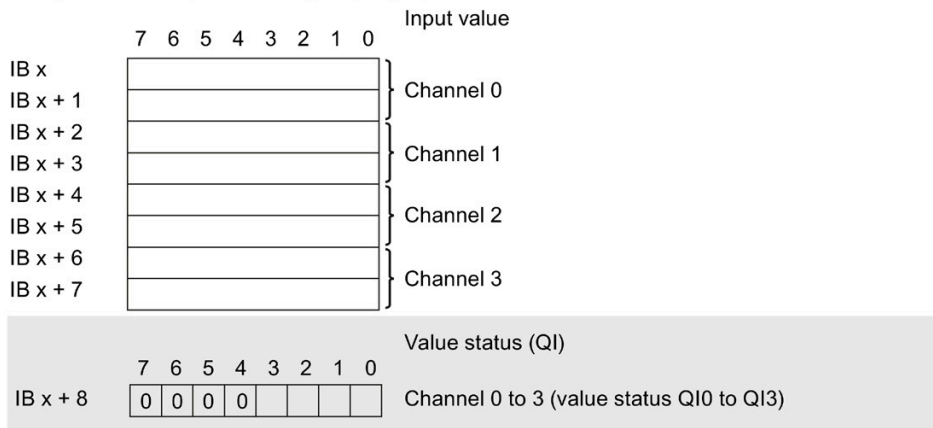

Figure 4-2 Address space of the AI 4xI 2-/4-wire ST with value status

Interrupts/diagnostics alarms

5.1 Status and error display

LED display

The figure below shows the LED displays (status and error displays) of the AI 4xI 2-/4-wire ST.

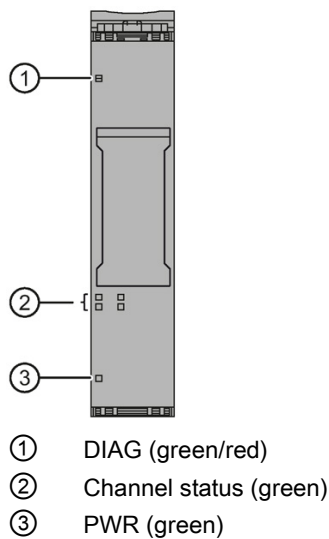





Figure 5-1 LED display

Meaning of the LED displays

The following tables show the meaning of the status and error displays. Measures for dealing with diagnostics alarms can be found in the section Diagnostics alarms (Page 25).



DIAG LED

Table 5- 1 DIAG LED fault/error display

DIAG LED	Meaning
 Off	Backplane bus supply of the ET 200SP not OK
 Flashes	Module parameters not assigned
 On	Module parameters assigned and no module diagnostics
 Flashes	Module parameters assigned and module diagnostics



Channel status LED

Table 5- 2 Status display of the channel status LED

Channel status LED	Meaning
 Off	Channel disabled
 On	Channel activated

PWR LED

Table 5- 3 Status display of the PWR LED

PWR LED	Meaning
 Off	No supply voltage L+
 On	Supply voltage L+ present

5.2 Interrupts

The analog input module AI 4xI 2-/4-wire ST supports diagnostics interrupts.

Diagnostics interrupt

The module generates a diagnostics interrupt for the following events:

- Channel temporarily unavailable
- Short-circuit (current, 2-wire transducer)
- Wire break (current 4 to 20 mA)
- Low limit violated
- High limit violated
- Error
- Parameter assignment error
- Supply voltage missing

5.3 Diagnostics alarms

A diagnostics alarm is generated and the DIAG-LED flashes on the module for each diagnostics event. You can read out the diagnostics alarms, for example, in the diagnostics buffer of the CPU. You can evaluate the error codes with the user program.

Table 5- 4 Diagnostics alarms, their meaning and how to deal with them

Diagnostics alarm	Error code	Meaning	Solution
Short-circuit (2-wire transducer, current)*	1H	Sensor supply to ground	Correct the module/encoder tuning
		Input to sensor supply	
Wire break (current) **	6H	Impedance of encoder circuit too high.	Use a different encoder type or modify the wiring, for example, using cables with a larger cross-section
		Wire break between the module and sensor	Connect the cable
		Channel not connected (open)	<ul style="list-style-type: none"> • Disable diagnostics • Connect the sensor contacts
High limit violated	7H	Value is above the overrange.	Correct the module/encoder tuning
Low limit violated	8H	Value is below the underrange.	Correct the module/encoder tuning
Error	9H	Internal module error occurred.	Replace module
Parameter assignment error	10H	<ul style="list-style-type: none"> • The module cannot evaluate parameters for the channel. • Incorrect parameter assignment. 	Correct the parameter assignment

5.3 Diagnostics alarms

Diagnostics alarm	Error code	Meaning	Solution
Supply voltage missing	11 _H	No or insufficient supply voltage L+	<ul style="list-style-type: none"> • Check supply voltage L+ on the BaseUnit • Check BaseUnit type
Channel temporarily unavailable	1F _H	Firmware update in progress or update has been canceled. The module does not read any process values in this state.	<ul style="list-style-type: none"> • Wait for firmware update. • Restart the firmware update.

* Short-circuit of the encoder supply to ground and/or of the input signal to the encoder supply of a channel can have a temporary effect on other channels (duration < 0.5 s). This means the short-circuit diagnostics can also be reported for unaffected channels and/or the measured value can be affected temporarily.

** In case of activated smoothing the module calculates the measured values across several module cycles. The module only generates the wire break diagnosis if the smoothed measured value is stable. After the wire break has been eliminated, the module supplies stable measured values again depending on the set smoothing level.

Technical specifications

6.1 Technical specifications

Technical specifications of the AI 4xI 2-/4-wire ST

The following table shows the technical specifications as of 06/2020. You will find a data sheet including daily updated technical specifications on the Internet (<https://support.industry.siemens.com/cs/ww/en/pv/6ES7134-6GD01-0BA1/td?dl=en>).

Article number	6ES7134-6GD01-0BA1
General information	
Product type designation	AI 4xI 2-/4-wire ST
HW functional status	From FS02
Firmware version	
<ul style="list-style-type: none"> FW update possible 	Yes
usable BaseUnits	BU type A0, A1
Color code for module-specific color identification plate	CC03
Product function	
<ul style="list-style-type: none"> I&M data 	Yes; I&M0 to I&M3
<ul style="list-style-type: none"> Isochronous mode 	No
<ul style="list-style-type: none"> Measuring range scalable 	No
Engineering with	
<ul style="list-style-type: none"> STEP 7 TIA Portal configurable/integrated as of version 	V14 / -
<ul style="list-style-type: none"> STEP 7 configurable/integrated as of version 	V5.6 and higher
<ul style="list-style-type: none"> PCS 7 configurable/integrated as of version 	V8.1 SP1
<ul style="list-style-type: none"> PROFIBUS as of GSD version/GSD revision 	One GSD file each, Revision 3 and 5 and higher
<ul style="list-style-type: none"> PROFINET as of GSD version/GSD revision 	GSDML V2.3
Operating mode	
<ul style="list-style-type: none"> Oversampling 	No
<ul style="list-style-type: none"> MSI 	No
CiR – Configuration in RUN	
Reparameterization possible in RUN	Yes
Calibration possible in RUN	No

6.1 Technical specifications

Article number	6ES7134-6GD01-0BA1
Supply voltage	
Rated value (DC)	24 V
permissible range, lower limit (DC)	19.2 V
permissible range, upper limit (DC)	28.8 V
Reverse polarity protection	Yes
Input current	
Current consumption, max.	37 mA; without sensor supply
24 V encoder supply	
<ul style="list-style-type: none"> • 24 V 	Yes
<ul style="list-style-type: none"> • Short-circuit protection 	Yes
<ul style="list-style-type: none"> • Output current, max. 	20 mA; max. 50 mA per channel for a duration < 10 s
Power loss	
Power loss, typ.	0.85 W; Without encoder supply voltage
Address area	
Address space per module	
<ul style="list-style-type: none"> • Address space per module, max. 	8 byte; + 1 byte for QI information
Hardware configuration	
Automatic encoding	
<ul style="list-style-type: none"> • Mechanical coding element 	Yes
Selection of BaseUnit for connection variants	
<ul style="list-style-type: none"> • 2-wire connection 	BU type A0, A1
<ul style="list-style-type: none"> • 4-wire connection 	BU type A0, A1
Analog inputs	
Number of analog inputs	4; Differential inputs
permissible input current for current input (destruction limit), max.	50 mA
Cycle time (all channels), min.	Sum of the basic conversion times and additional processing times (depending on the parameterization of the active channels)
Input ranges (rated values), currents	
<ul style="list-style-type: none"> • 0 to 20 mA <ul style="list-style-type: none"> – Input resistance (0 to 20 mA) 	Yes; 16 bit incl. sign 100 Ω; + approx. 0.7 V diode forward voltage in 2-wire operation
<ul style="list-style-type: none"> • -20 mA to +20 mA <ul style="list-style-type: none"> – Input resistance (-20 mA to +20 mA) 	Yes 100 Ω
<ul style="list-style-type: none"> • 4 mA to 20 mA <ul style="list-style-type: none"> – Input resistance (4 mA to 20 mA) 	Yes; 15 bit 100 Ω; + approx. 0.7 V diode forward voltage in 2-wire operation
Cable length	
<ul style="list-style-type: none"> • shielded, max. 	1 000 m

Article number	6ES7134-6GD01-0BA1
Analog value generation for the inputs	
Measurement principle	integrating (Sigma-Delta)
Integration and conversion time/resolution per channel	
<ul style="list-style-type: none"> Resolution with overrange (bit including sign), max. 	16 bit
<ul style="list-style-type: none"> Integration time, parameterizable 	Yes
<ul style="list-style-type: none"> Interference voltage suppression for interference frequency f_1 in Hz 	16.6 / 50 / 60 Hz
<ul style="list-style-type: none"> Conversion time (per channel) 	180 / 60 / 50 ms
Smoothing of measured values	
<ul style="list-style-type: none"> Number of smoothing levels 	4; None; 4/8/16 times
<ul style="list-style-type: none"> parameterizable 	Yes
Encoder	
Connection of signal encoders	
<ul style="list-style-type: none"> for voltage measurement 	No
<ul style="list-style-type: none"> for current measurement as 2-wire transducer 	Yes
<ul style="list-style-type: none"> – Burden of 2-wire transmitter, max. 	650 Ω
<ul style="list-style-type: none"> for current measurement as 4-wire transducer 	Yes
Errors/accuracies	
Linearity error (relative to input range), (+/-)	0.01 %
Temperature error (relative to input range), (+/-)	0.005 %/K
Crosstalk between the inputs, min.	50 dB; Applies to up to ± 5 V overvoltage in other channels
Repeat accuracy in steady state at 25 °C (relative to input range), (+/-)	0.05 %
Operational error limit in overall temperature range	
<ul style="list-style-type: none"> Current, relative to input range, (+/-) 	0.5 %
Basic error limit (operational limit at 25 °C)	
<ul style="list-style-type: none"> Current, relative to input range, (+/-) 	0.3 %
Interference voltage suppression for $f = n \times (f_1 \pm 1 \%)$, $f_1 =$ interference frequency	
<ul style="list-style-type: none"> Series mode interference (peak value of interference < rated value of input range), min. 	70 dB
<ul style="list-style-type: none"> Common mode voltage, max. 	10 V
<ul style="list-style-type: none"> Common mode interference, min. 	90 dB

6.1 Technical specifications

Article number	6ES7134-6GD01-0BA1
Interrupts/diagnostics/status information	
Diagnostics function	Yes
Alarms	
• Diagnostic alarm	Yes
• Limit value alarm	No
Diagnostic messages	
• Monitoring the supply voltage	Yes
• Wire-break	Yes; at 4 to 20 mA
• Short-circuit	Yes; 2-wire mode: Short-circuit of the encoder supply to ground or of an input to the encoder supply
• Group error	Yes
• Overflow/underflow	Yes
Diagnostics indication LED	
• Monitoring of the supply voltage (PWR-LED)	Yes; green LED
• Channel status display	Yes; green LED
• for channel diagnostics	No
• for module diagnostics	Yes; green/red LED
Potential separation	
Potential separation channels	
• between the channels	Yes; channel group-specific between 2-wire current input group and 4-wire voltage input group
• between the channels and backplane bus	Yes
• between the channels and the power supply of the electronics	Yes; only for 4-wire transducer
Permissible potential difference	
between the inputs (UCM)	10 V DC
Isolation	
Isolation tested with	707 V DC (type test)
Ambient conditions	
Ambient temperature during operation	
• horizontal installation, min.	-30 °C
• horizontal installation, max.	60 °C
• vertical installation, min.	-30 °C
• vertical installation, max.	50 °C
Altitude during operation relating to sea level	
• Installation altitude above sea level, max.	5 000 m; Restrictions for installation altitudes > 2 000 m, see manual

Article number	6ES7134-6GD01-0BA1
Dimensions	
Width	15 mm
Height	73 mm
Depth	58 mm
Weights	
Weight, approx.	31 g

Dimension drawing

See manual ET 200SP BaseUnits
(<http://support.automation.siemens.com/WW/view/en/59753521>)

Parameter data record

A.1 Dependencies when configuring with GSD file

When configuring the module with a GSD file, remember that the settings of some parameters are dependent on each other.

Configuring with a PROFINET GSD file

The table lists the properties and their dependencies on the measuring type and measuring range for PROFINET.

Measuring type	Measuring range	Diagnostics				
		No supply voltage L+	Short-circuit to M	Overflow	Underflow	Wire break
deactivated		*	*	*	*	*
Current (4-wire connection)	0..20 mA	x	-	x	x	-
	4..20 mA	x	-	x	x	x
	±20 mA	x	-	x	x	-
Current (2-wire connection)	0..20 mA	x	x	x	x	-
	4..20 mA	x	x	x	x	x

x = Property is allowed, - = Property is **not allowed**, * = Property is not relevant

Configuring with a PROFIBUS GSD file

The table lists the properties and their dependencies on the measuring type and measuring range for PROFIBUS.

Measuring type	Measuring range	Diagnostics			
		No supply voltage L+	Short-circuit to M	Overflow/ Underflow	Wire break
deactivated		*	*	*	*
Current (4-wire connection)	0..20 mA	x	-	x	-
	4..20 mA	x	-	x	x
	±20 mA	x	-	x	-
Current (2-wire connection)	0..20 mA	x	x	x	-
	4..20 mA	x	x	x	x

x = Property is allowed, - = Property is **not allowed**, * = Property is not relevant

A.2 Parameter assignment and structure of the parameter data record

The data record of the module has an identical structure, regardless of whether you configure the module with PROFIBUS DP or PROFINET IO. With data record 128, you can reconfigure the module in your user program regardless of your programming. This means that you can use all the functions of the module even if you configured it via PROFIBUS-GSD.

Parameter assignment in the user program

You can change the parameters of the module in RUN. For example, the voltage or current values of selected channels can be changed in RUN without having an effect on the other channels.

Changing parameters in RUN

The "WRREC" instruction is used to transfer the parameters to the module using data record 128. The parameters set in STEP 7 are not changed in the CPU, which means that the parameters set in STEP 7 will be valid again after a restart.

Output parameter STATUS

If errors occur when transferring parameters with the "WRREC" instruction, the module continues operation with the previous parameter assignment. The STATUS output parameter contains a corresponding error code.

You will find a description of the "WRREC" instruction and the error codes in the STEP 7 online help.

Structure of data record 128

Note

Channel 0 contains the diagnostics for the entire module.

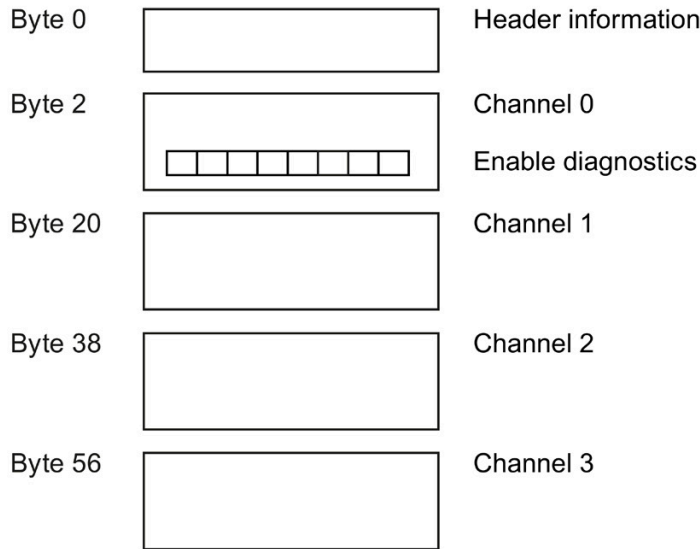

Figure A-1 Structure of data record 128

Header information

The figure below shows the structure of the header information.

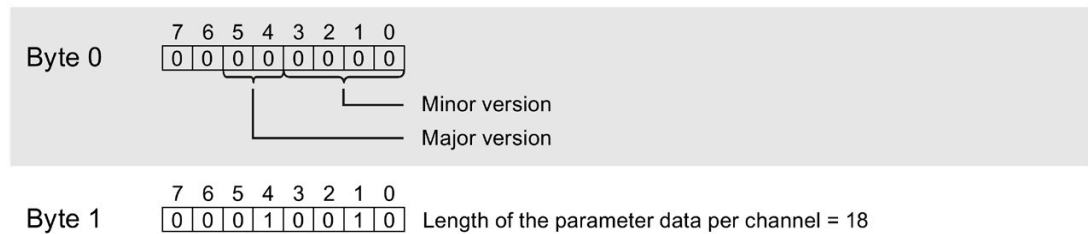
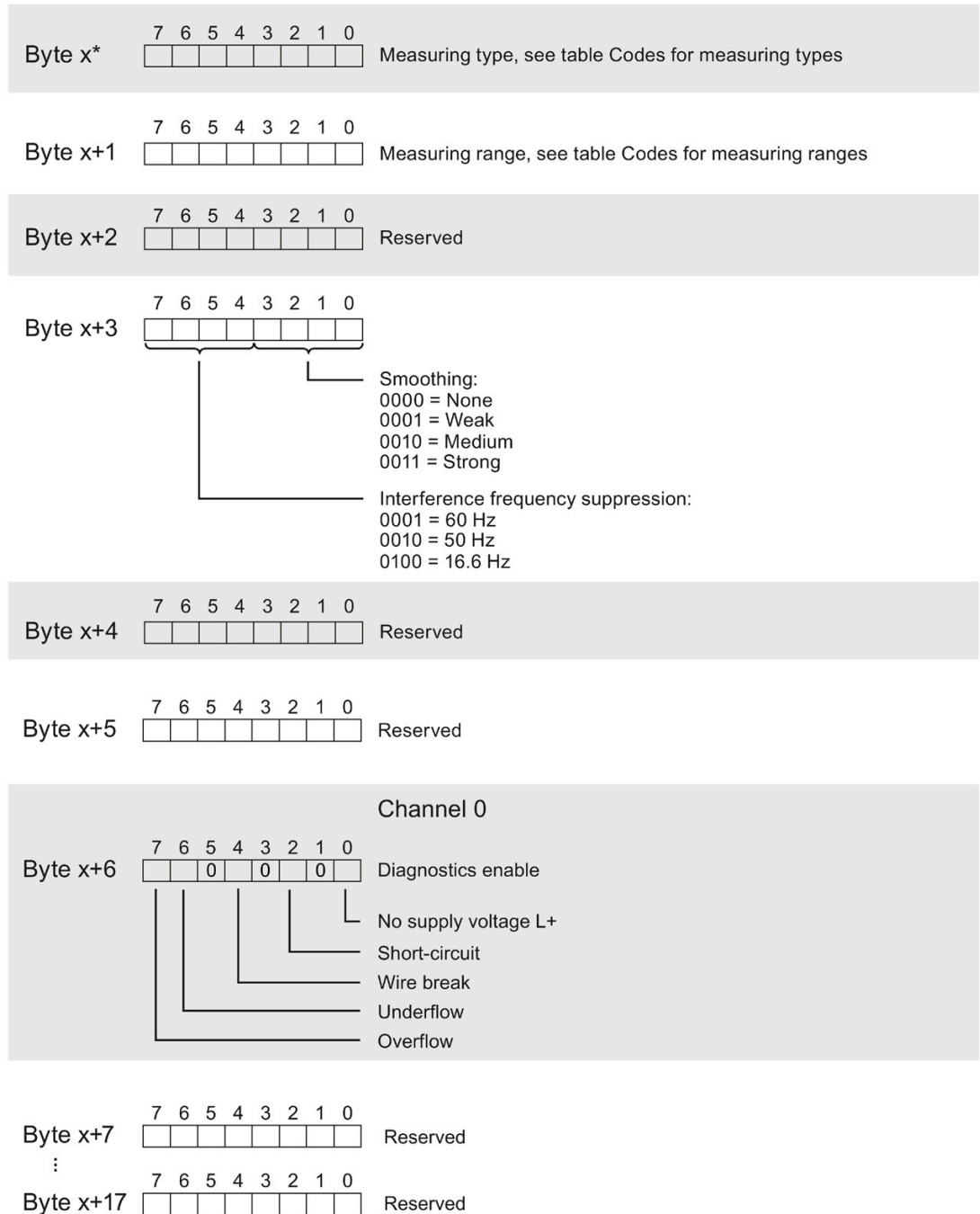

Figure A-2 Header information

Parameters

The figure below shows the structure of the parameters for channels 0 to 3.

You enable a parameter by setting the corresponding bit to "1".



* $x = 2 + (\text{channel number} \times 18)$; channel number= 0 to 3

Figure A-3 Structure of byte x to x+17 for channels 0 to 3

Codes for the measuring type

The following table contains the codes for the measuring types of the analog input module. You must enter these codes at byte x (see previous figure).

Table A- 1 Codes for the measuring type

Measuring type	Coding
Deactivated	0000 0000
Current, 4-wire transducer	0000 0010
Current, 2-wire transducer	0000 0011

Codes for the measuring range

The following table contains the codes for the measuring ranges of the analog input module. You enter these codes at byte x+1 (see previous figure).

Table A- 2 Codes for the measuring range

Measuring range	Coding
0 to 20 mA	0000 0010
4 to 20 mA	0000 0011
±20 mA	0000 0100

A.3 Error in transferring the data record analog input

Error transferring the data record

The module always checks all values of the data record to be sent. The module applies the values from the data record only when all values have been transmitted without errors.

The WRREC instruction for writing data records returns corresponding error codes when errors occur in the STATUS parameter, see also the description of the "STATUS" parameter in the STEP 7 online help).

The following table shows the module-specific error codes and their meaning for parameter data record 128.

Error code in STATUS parameter (hexadecimal)				Meaning	Solution
Byte 0	Byte 1	Byte 2	Byte 3		
DF	80	B0	xx	Number of the data record unknown.	Enter a valid number for the data record.
DF	80	B1	xx	Length of the data record incorrect.	Enter a valid value for the data record length.
DF	80	B2	xx	Slot invalid or cannot be accessed.	<ul style="list-style-type: none"> Check the station to determine whether the module is plugged or pulled. Check the assigned values for the parameters of the WRREC instruction.
DF	80	E0	xx	Wrong version or error in the header information.	Correct the version, length and number of parameter blocks.
DF	80	E1	01	Reserved bit set	Check the parameters of the module.
DF	80	E1	02	Invalid diagnostics enable bit set for operating mode.	Check the parameters of the module.
DF	80	E1	05	Invalid coding set for measuring range / measurement type.	Check the parameters of the module.
DF	80	E1	08	Invalid coding set for interference frequency suppression / integration time.	Check the parameters of the module.
DF	80	E1	09	Invalid coding for smoothing.	Check the parameters of the module.

B

Representation of analog values

This appendix shows the analog values for all measuring ranges that you can use with the analog module.

Measured value resolution

The resolution of the analog values differs depending on the analog module and its assigned parameters.

The table below shows the representation of binary analog values and of the associated decimal and hexadecimal units of the analog values.

Each analog value is written left aligned to the tags. The bits marked with "x" are set to "0".

Table B- 1 Resolution of the analog values

Resolution in bits including sign	Values		Analog value	
	Decimal	Hexadecimal	High byte	Low byte
14	4	4 _H	Sign 0 0 0 0 0 0 0	0 0 0 0 0 1 x x
15	2	2 _H	Sign 0 0 0 0 0 0 0	0 0 0 0 0 0 1 x
16	1	1 _H	Sign 0 0 0 0 0 0 0	0 0 0 0 0 0 0 1

B.1 Representation of input ranges

In the following tables, you can find the digitized representation of the bipolar and unipolar input ranges. The resolution is 16 bits.

Table B- 2 Bipolar input ranges

Dec. value	Measured value in %	Data word																Range
		2 ¹⁵	2 ¹⁴	2 ¹³	2 ¹²	2 ¹¹	2 ¹⁰	2 ⁹	2 ⁸	2 ⁷	2 ⁶	2 ⁵	2 ⁴	2 ³	2 ²	2 ¹	2 ⁰	
32767	>117.589	0	1	1	1	1	1	1	1	1	1	1	1	1	1	1	1	Overflow
32511	117.589	0	1	1	1	1	1	1	0	1	1	1	1	1	1	1	1	Overrange
27649	100.004	0	1	1	0	1	1	0	0	0	0	0	0	0	0	0	1	
27648	100.000	0	1	1	0	1	1	0	0	0	0	0	0	0	0	0	0	Nominal range
1	0.003617	0	0	0	0	0	0	0	0	0	0	0	0	0	0	0	1	
0	0.000	0	0	0	0	0	0	0	0	0	0	0	0	0	0	0	0	
-1	-0.003617	1	1	1	1	1	1	1	1	1	1	1	1	1	1	1	1	
-27648	-100.000	1	0	0	1	0	1	0	0	0	0	0	0	0	0	0	0	
-27649	-100.004	1	0	0	1	0	0	1	1	1	1	1	1	1	1	1	1	Underrange
-32512	-117.593	1	0	0	0	0	0	0	1	0	0	0	0	0	0	0	0	Underflow
-32768	<-117.593	1	0	0	0	0	0	0	0	0	0	0	0	0	0	0	0	

Table B- 3 Unipolar input ranges

Dec. value	Measured value in %	Data word																Range
		2 ¹⁵	2 ¹⁴	2 ¹³	2 ¹²	2 ¹¹	2 ¹⁰	2 ⁹	2 ⁸	2 ⁷	2 ⁶	2 ⁵	2 ⁴	2 ³	2 ²	2 ¹	2 ⁰	
32767	>117.589	0	1	1	1	1	1	1	1	1	1	1	1	1	1	1	1	Overflow
32511	117.589	0	1	1	1	1	1	1	0	1	1	1	1	1	1	1	1	Overrange
27649	100.004	0	1	1	0	1	1	0	0	0	0	0	0	0	0	0	1	
27648	100.000	0	1	1	0	1	1	0	0	0	0	0	0	0	0	0	0	Nominal range
1	0.003617	0	0	0	0	0	0	0	0	0	0	0	0	0	0	0	1	
0	0.000	0	0	0	0	0	0	0	0	0	0	0	0	0	0	0	0	
-1	-0.003617	1	1	1	1	1	1	1	1	1	1	1	1	1	1	1	1	
-4864	-17.593	1	1	1	0	1	1	0	1	0	0	0	0	0	0	0	0	
-32768	<-17.593	1	0	0	0	0	0	0	0	0	0	0	0	0	0	0	0	Underflow

B.2 Representation of analog values in the current measuring ranges

The following tables list the decimal and hexadecimal values (codes) of the possible current measuring ranges.

Table B- 4 Current measuring range ±20 mA

Values		Current measuring range		Range
Dec.	Hex.	±20 mA		
32767	7FFF	>23.52 mA		Overflow
32511	7EFF	23.52 mA		Overrange
27649	6C01			
27648	6C00	20 mA		Nominal range
20736	5100	15 mA		
1	1	723.4 nA		
0	0	0 mA		
-1	FFFF			
-20736	AF00	-15 mA		
-27648	9400	-20 mA		
-27649	93FF			Underrange
-32512	8100	-23.52 mA		
-32768	8000	<-23.52 mA		Underflow

Table B- 5 Current measuring ranges 0 to 20 mA and 4 to 20 mA

Values		Current measuring range		Range
Dec.	Hex.	0 to 20 mA *	4 to 20 mA	
32767	7FFF	>23.52 mA	>22.81 mA	Overflow
32511	7EFF	23.52 mA	22.81 mA	Overrange
27649	6C01			
27648	6C00	20 mA	20 mA	Nominal range
20736	5100	15 mA	16 mA	
1	1	723.4 nA	4 mA + 578.7 nA	
0	0	0 mA	4 mA	
-1	FFFF			
-4864	ED00	-3.52 mA	1.185 mA	Underrange
-32768	8000	<-3.52 mA	<1.185 mA	
				Underflow

* For measuring type "2-wire transducer", negative values are not possible for the range "0 to 20 mA". Therefore, no underrange or underflow exists here.