



million  
in one

**milltronics**

BW100

**SIEMENS**

**Safety Guidelines:** Warning notices must be observed to ensure personal safety as well as that of others, and to protect the product and the connected equipment. These warning notices are accompanied by a clarification of the level of caution to be observed.

**Qualified Personnel:** This device/system may only be set up and operated in conjunction with this manual. Qualified personnel are only authorized to install and operate this equipment in accordance with established safety practices and standards.

**Unit Repair and Excluded Liability:**

- The user is responsible for all changes and repairs made to the device by the user or the user's agent.
- All new components are to be provided by Siemens Milltronics Process Instruments Inc.
- Restrict repair to faulty components only.
- Do not reuse faulty components.

**Warning:** This product can only function properly and safely if it is correctly transported, stored, installed, set up, operated, and maintained.

**Note:** Always use product in accordance with specifications.

<b>Copyright Siemens Milltronics Process Instruments Inc. 2007. All Rights Reserved</b>	<b>Disclaimer of Liability</b>
This document is available in bound version and in electronic version. We encourage users to purchase authorized bound manuals, or to view electronic versions as designed and authored by Siemens Milltronics Process Instruments Inc. Siemens Milltronics Process Instruments Inc. will not be responsible for the contents of partial or whole reproductions of either bound or electronic versions.	While we have verified the contents of this manual for agreement with the instrumentation described, variations remain possible. Thus we cannot guarantee full agreement. The contents of this manual are regularly reviewed and corrections are included in subsequent editions. We welcome all suggestions for improvement.  Technical data subject to change.

MILLTRONICS® is a registered trademark of Siemens Milltronics Process Instruments Inc.

**Contact SMPI Technical Publications at the following address:**

Technical Publications  
Siemens Milltronics Process Instruments Inc.  
1954 Technology Drive, P.O. Box 4225  
Peterborough, Ontario, Canada, K9J 7B1  
Email: [techpubs.smpi@siemens.com](mailto:techpubs.smpi@siemens.com)

- For a selection of Siemens Milltronics level measurement manuals, go to: **[www.siemens.com/processautomation](http://www.siemens.com/processautomation)**. Under Process Instrumentation, select *Level Measurement* and then go to the manual archive listed under the product family.
- For a selection of Siemens Milltronics weighing manuals, go to: **[www.siemens.com/processautomation](http://www.siemens.com/processautomation)**. Under Weighing Technology, select *Continuous Weighing Systems* and then go to the manual archive listed under the product family.

# Table of Contents

---

<b>Milltronics BW100</b> .....	1
Milltronics BW100 Features .....	1
Safety Notes .....	2
The Manual .....	2
<b>Specifications</b> .....	3
<b>Installation</b> .....	6
Dimensions .....	6
Interconnection .....	7
System Diagram .....	7
Terminal Block Layout .....	8
Load Cell - Single .....	9
Load Cell - Dual .....	10
Speed Sensor .....	11
Auto Zero .....	12
Remote Totalizer 1 .....	12
Analog Output .....	12
Remote Totalizer 2 .....	13
Relay Output .....	13
Communication .....	14
Bipolar Current Loop .....	14
Power Connections .....	15
AC Power .....	15
DC Power .....	15
Converter .....	16
Optional Dolphin Interface .....	16
Units Sticker .....	16
<b>Start Up</b> .....	17
Orientation .....	17
Display and Keypad .....	17
PROGRAM Mode .....	18
Maneuvering .....	18
Master Reset .....	21
Load Cell Balancing .....	21
Quick Start .....	23
Start Up .....	24
Zero Calibration .....	26
Span Calibration .....	27
<b>Recalibration</b> .....	29
Belt Speed Compensation .....	29
Material Tests .....	30
Design Changes .....	31
Recalibration .....	31

Routine Zero .....	32
Initial Zero .....	33
Direct Zero .....	34
Routine Span .....	35
Initial Span .....	36
Direct Span .....	37
Factoring .....	38
Linearization .....	39
<b>Operation .....</b>	<b>42</b>
Load Sensing .....	42
Speed Sensing .....	42
Modes of Operation .....	42
Damping .....	43
Analog Output .....	43
Relay Output .....	44
Totalization .....	45
Auto Zero .....	46
<b>Communications .....</b>	<b>47</b>
Protocol .....	47
Data Field Descriptions .....	48
Message Requests .....	48
Message Responses .....	49
<b>Parameters .....</b>	<b>50</b>
Quick Start (P005 to P017) .....	50
Relay/Alarm Function (P100 - P117) .....	53
mA Output Parameters (P200 - P220) .....	53
Load Cell Balancing Parameters (P291 - P295) .....	55
Linearization Parameters (P390 - P396) .....	57
Totalization (P619 - P648) .....	58
Communication (P751 - P761) .....	61
Test and Diagnostic (P900 - P951) .....	62
<b>Troubleshooting .....</b>	<b>65</b>
Maintenance .....	67
Software Updates .....	67
<b>Appendix I .....</b>	<b>68</b>
Alphabetical Parameter List .....	68
Program Record .....	70
<b>Appendix II: Software Revision History .....</b>	<b>72</b>
<b>Index .....</b>	<b>73</b>

# Milltronics BW100

**Note:** The Milltronics BW100 is to be used only in the manner outlined in this instruction manual.

The Milltronics BW100 is an economical integrator for use with belt scales. The speed and load signals from the conveyor and scale, are processed to derive rate of material flow and totalization.

The primary values of speed and load, and the derived values of rate and total are available for display on the local LCD, or as output in the form of analog mA, alarm relay and remote totalization. BW100 supports Milltronics proprietary bipolar current loop for long distance communication to PLC or computer. It is also compatible with Milltronics Dolphin interface for remote display, programming and software upgrading.

## Milltronics BW100 Features

- multi-field LCD display
- two remote totalizer contacts
- current loop for communications
- Dolphin compatibility
- programmable relay
- isolated mA output
- rate linearization
- local keypad
- Auto Zero

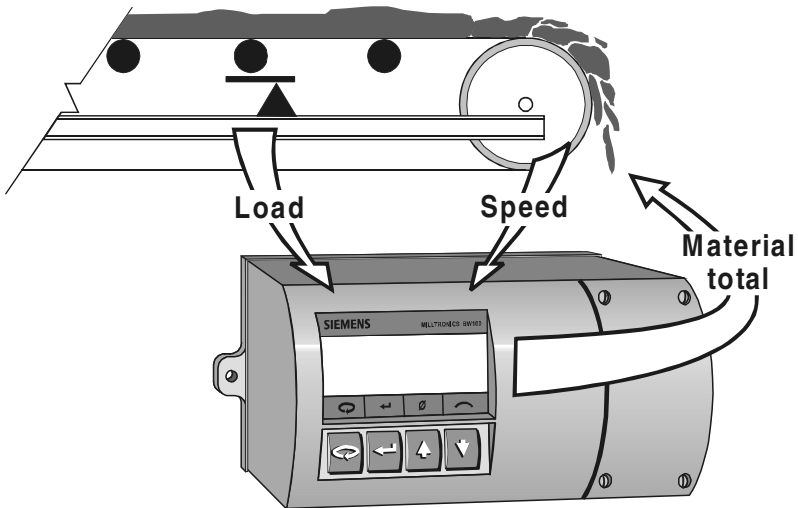

# Safety Notes

Special attention must be paid to warnings and notes highlighted from the rest of the text by grey boxes.



**WARNING** means that failure to observe the necessary precautions can result in death, serious injury, and/or considerable material damage.

**Note:** means important information about the product or that part of the operating manual.

## The Manual

It is essential to refer to this manual for proper installation and operation of your BW100 belt scale integrator. As the BW100 must be connected to a belt scale, and optionally a speed sensor, refer to their manuals as well.

The manual is designed to help you get the most out of your BW100, and it provides information on the following

- How to install the unit
- How to program the unit
- How to operate the keypad and read the display
- How to do an initial Start Up
- How to optimize and maintain accurate operation of the unit
- Outline diagrams
- Wiring diagrams
- Parameter values
- Parameter uses
- Modbus register mapping
- Modem configuration

**Note:** The Milltronics BW100 is to be used only in the manner outlined in this instruction manual.

If you have any questions, comments, or suggestions about the manual contents, please email us at [techpubs.smpi@siemens.com](mailto:techpubs.smpi@siemens.com).

For the complete library of Siemens Milltronics manuals, go to [www.siemens.com.processautomation](http://www.siemens.com.processautomation).

# Specifications

---

## Power

- standard: 100/115/200/230 VAC  $\pm$  15%, 50/60 Hz, 15VA
- optional: 10 to 15 V DC, 15 W  
18 to 30 V DC, 15 W

## Application

- compatible with Siemens Milltronics belt scales or equivalent

## Accuracy

- 0.25% of full scale mA range below 50  $\mu$ A
- 0.1% of full scale mA range between 50  $\mu$ A and 20 mA

**Note:** The accuracy in the presence of RF fields per IEC61000-4-34 Radiated Immunity testing.

## Resolution

- 0.1 % of full scale

## Environmental

- location: indoor/outdoor
- altitude: 2000 m max
- ambient temperature: -20 to 50 °C (-5 to 122 °F)
- relative humidity: suitable for outdoor
- installation category: II
- pollution degree: 4

## Enclosure

- polypropylene alloy
- Type 4X/NEMA 4X/IP 65
- sealed electronics compartment
- integral junction box with termination block for 0.2 to 4 mm solid or 0.2 to 2.5 mm stranded (12 to 24 AWG)

## Programming

- via local 4-member keypad with silicone boot and/or Dolphin interface

## Display

- 38 x 100 mm (1.5 x 4") multi-field liquid crystal display

## Memory

- program stored in non-volatile FLASH memory, upgradable via Dolphin interface
- parameters stored in non-volatile EEPROM

## Inputs

- load cell: 0 to 30 mV per load cell, dual load cell applications  
0 to 45 mV per load cell, single load cell applications
- speed sensor: pulse train: 0-5 V low, 5-15 V high, 1 to 2000 Hz,  
or  
open collector switch  
or  
relay dry contact  
dry contact from external device
- auto zero:

## Outputs

- analog: - optically isolated 0/4 - 20 mA  
- 750  $\Omega$  max loading
- resolution: - 0.1% of 20 mA
- load cell: - 10 Vdc compensated for strain gauge type, 2 cells max,  
75 mA max
- speed sensor: - 12 Vdc, 50 mA max excitation
- remote totalizer 1: - contact closure 32 - 288 ms duration  
- open collector switch rated 30 Vdc, 100 mA max
- remote totalizer 2: - contact closure 32 - 288 ms duration  
- open collector switch rated 240 Vac/dc, 100 mA max
- relay output: programmable function 1 form **C** SPDT relay contact rated  
5 A at 250 Vac, non-inductive

## Communications

- Dolphin compatible
- proprietary bipolar current loop

## Cable/Separation:

- one load cell/LVDT:
  - non-sensing: Belden 8404, 4 wire shielded, 20 AWG or equivalent,  
150 m (500 ft.) max.
  - sensing: Belden 9260, 6 wire shielded, 20 AWG or equivalent,  
300 m (1000 ft.) max.
- two load cells:
  - non-sensing: Belden 9260, 6 wire shielded, 20 AWG or equivalent,  
150 m (500 ft.) max.
  - sensing: Belden 8418, 8 wire shielded, 20 AWG or equivalent,  
300 m (1000 ft.) max.



- speed sensor Belden 8770, 3 wire shielded, 18 AWG or equivalent, 300 m (1000 ft.) max.
- auto zero: Belden 8760, 1 pair, twisted/shielded, 18 AWG, 300 m (1000 ft.) max.
- remote total: Belden 8760, 1 pair, twisted/shielded, 18 AWG, 300 m (1000 ft.) max.
- analog output: Belden 8760, 1 pair, twisted/shielded, 18 AWG or equivalent
- bipolar current: Belden 9552, 2 pair, twisted/shielded, 18
- (comm. port) AWG, 3000 m (10,000 ft.) max. loop
- remote total Belden 8760, 1 pair, twisted/shielded, 18AWG,
- t1 (dc) 300 m (1000 ft.) max.

## Options:

- Speed Sensor: - Siemens Milltronics MD-36 series, or equivalent
- Dolphin: - Milltronics Windows based software interface and infrared ComVerter link

## Approvals:

- CE\*, CSA NRTL/C

\*EMC performance available upon request

# Installation

## Notes:

- Installation shall only be performed by qualified personnel and in accordance with local governing regulations.
- This product is susceptible to electrostatic shock. Follow proper grounding procedures.

## Dimensions

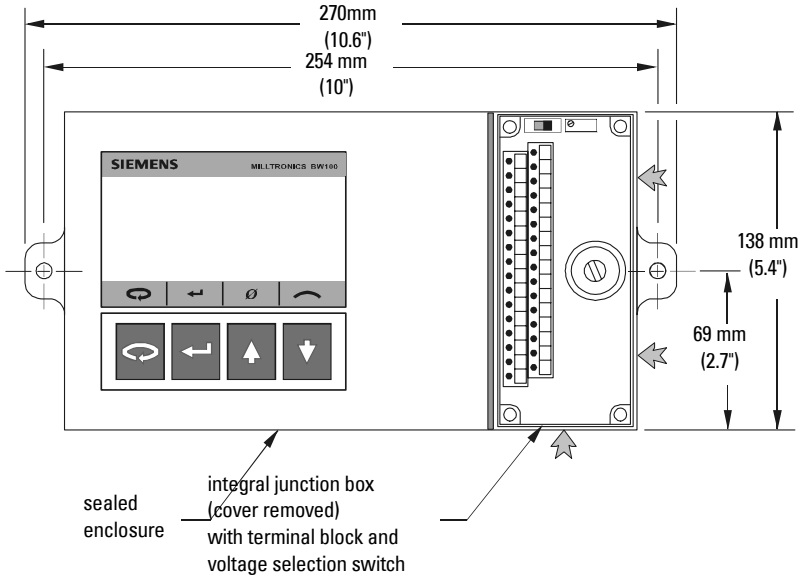

➔ Conduit entry area. Recommend drilling the enclosure with a hole saw and the use of suitable cable glands to maintain ingress rating.

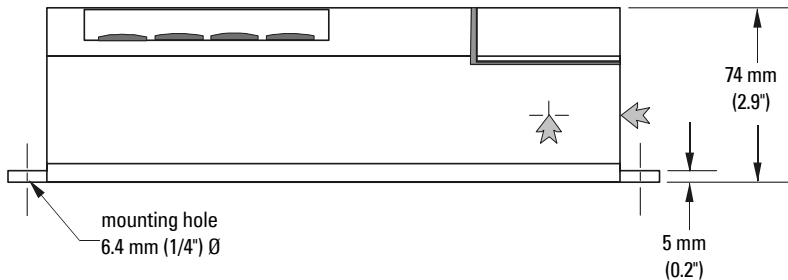

**Note:** Non metallic enclosure does not provide grounding between connections. Use grounding type bushings and jumpers.

# Interconnection

**Note:** Wiring may be run via common conduit. However these may not be run in the same conduit as high voltage contact or power wiring.

## System Diagram

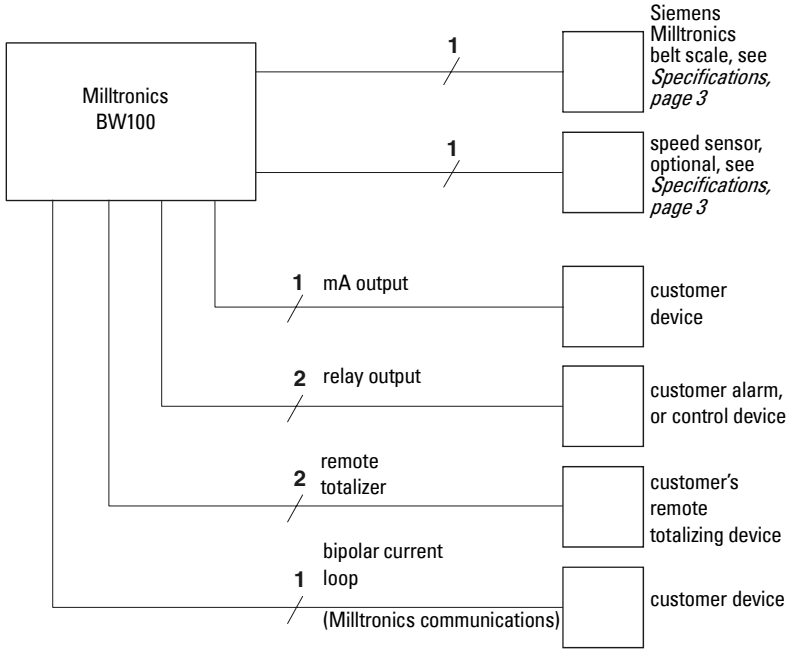

**Note:** Typical system capability. Not all components or their maximum quantity may be required.

# Terminal Block Layout

ac supply

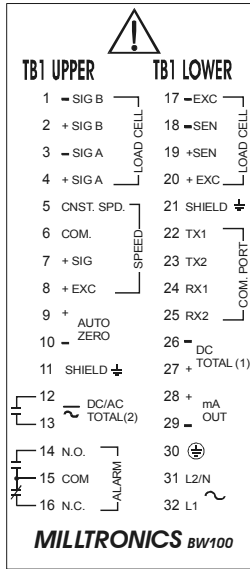

dc supply

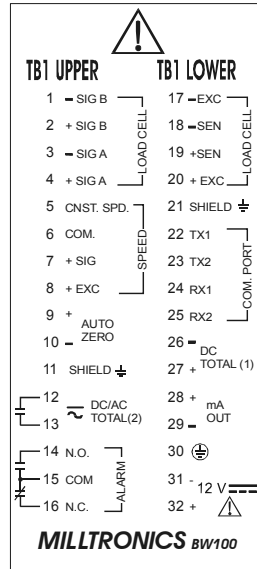
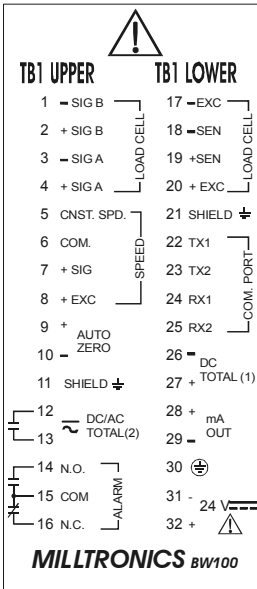

All field wiring must have insulation suitable for at least 250 V.



dc terminals shall be supplied from a SELV source in accordance with IEC-1010-1 Annex H.

# Load Cell - Single

**Note:** Colour code for load cells used on Siemens Milltronics Weighfeeders may be different than shown. Please refer to the supplied Weighfeeder wiring diagram.

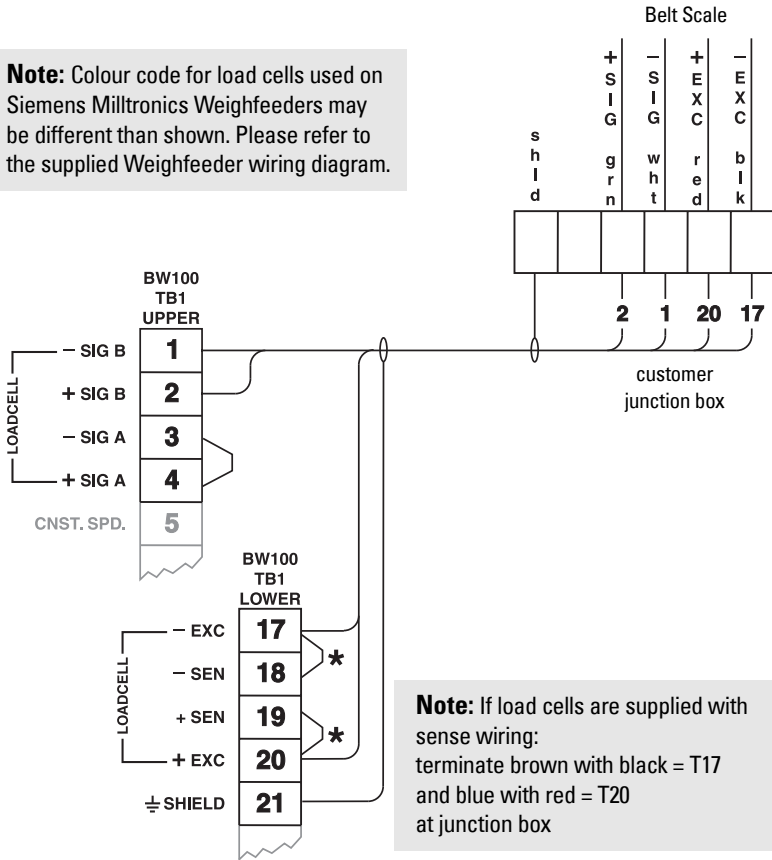

**Note:** If load cells are supplied with sense wiring: terminate brown with black = T17 and blue with red = T20 at junction box

Where separation between the BW100 and belt scale exceeds 150 m (500 ft.):

1. remove the jumpers BW100 TB1 – 17/18 and TB1 19/20
2. run additional conductors from:
  - BW100 TB1 – 18 to scale ‘- EXC’
  - BW100 TB1 – 19 to scale ‘+ EXC’

If the load cell wiring colours vary from those shown, or if extra wires are provided, consult Siemens Milltronics.

# Load Cell - Dual

**Note:** Colour code for load cells used on Siemens weighfeeders may be different than shown. Please refer to the supplied weighfeeder wiring diagram.

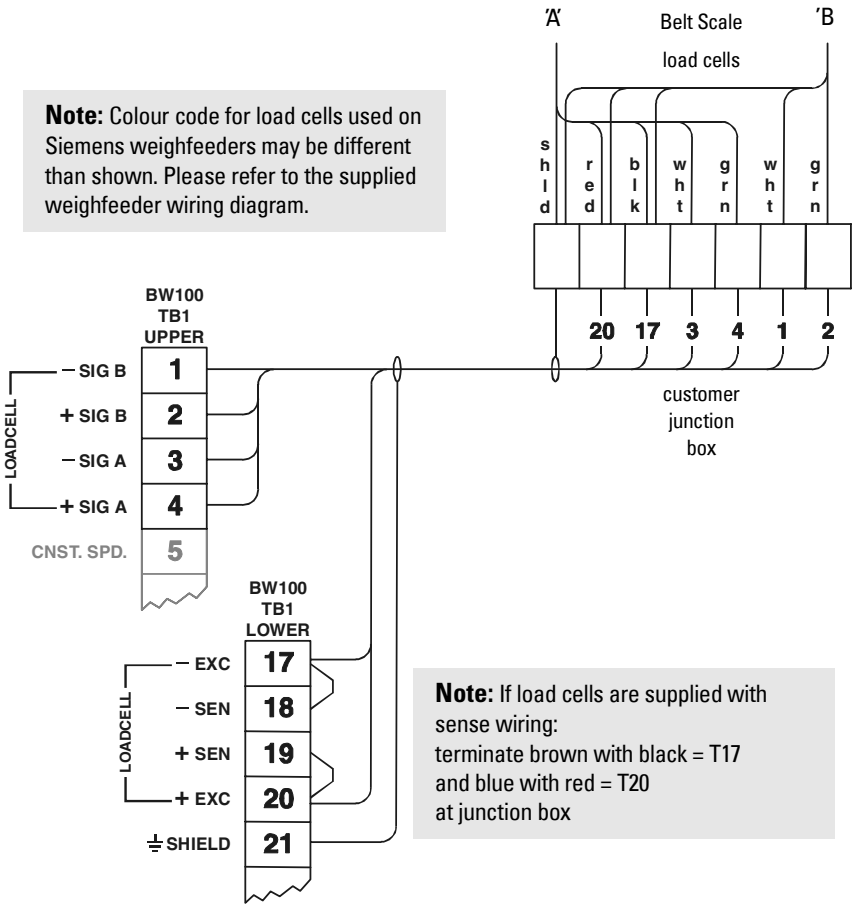

**Note:** If load cells are supplied with sense wiring:  
 terminate brown with black = T17  
 and blue with red = T20  
 at junction box

Where separation between the BW100 and belt scale exceeds 150 m (500 ft.):

1. remove the jumpers BW100 TB1 – 17/18 and TB1 19/20
2. run additional conductors from:  
 BW100 TB1 – 18 to scale ‘- EXC’  
 BW100 TB1 – 19 to scale ‘+ EXC’

If the load cell wiring colours vary from those shown, or if extra wires are provided, consult Siemens Milltronics.

# Speed Sensor

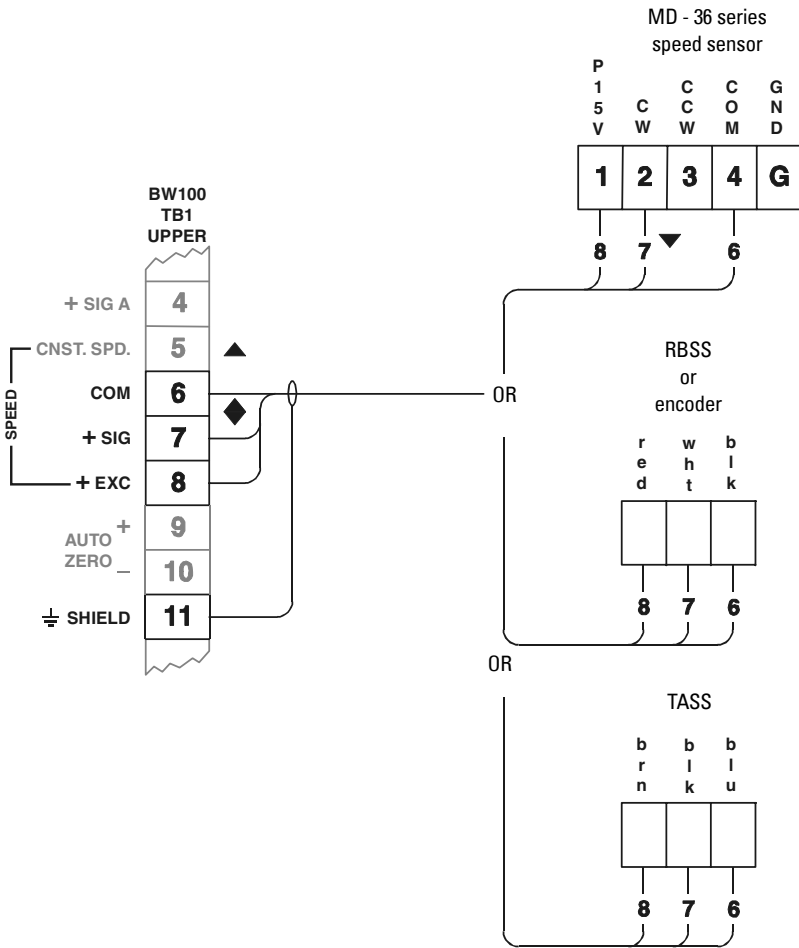

- ▼ Connect the BW100 TB1 – 7 to the MD - 36 series speed sensor terminal:
  - '2' for clockwise speed sensor shaft rotation
  - '3' for counter-clockwise speed sensor shaft rotation.

MD shaft rotation is viewed from the front cover side of the MD enclosure.

- ▲ If a speed sensor is not used, a jumper must be connected across the BW100 TB1 – 5 / 6. If a speed sensor is used, insure that the jumper is removed.
- ◆ Input device in the form of open collector transistor or dry contact across TB1 – 6 / 7 will also serve as a suitable speed signal.

# Auto Zero

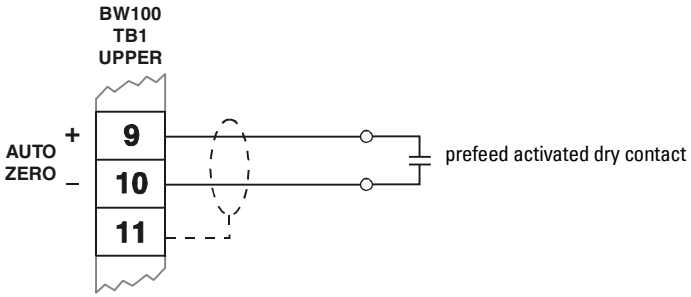

# Remote Totalizer 1

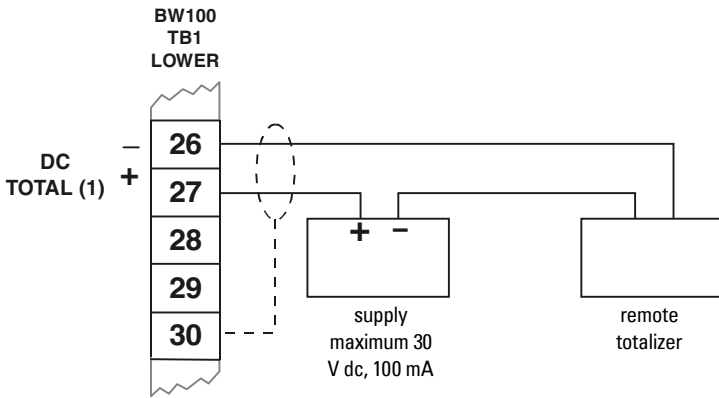

# Analog Output

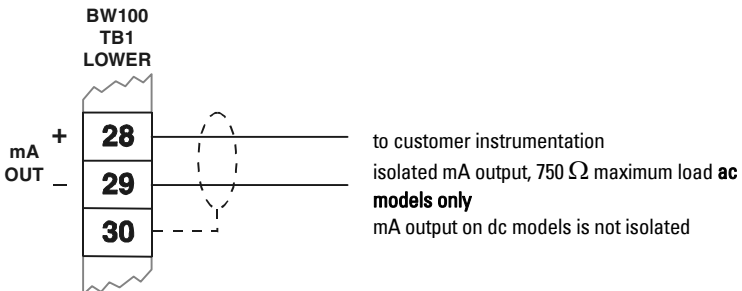



# Remote Totalizer 2

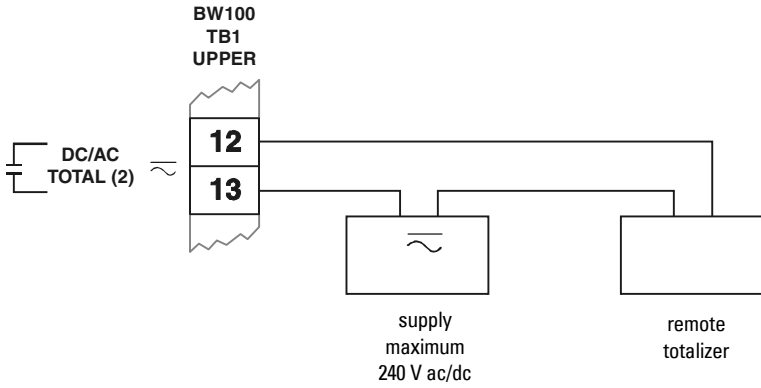

# Relay Output

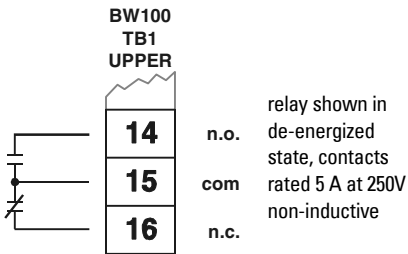

# Communication

## Bipolar Current Loop

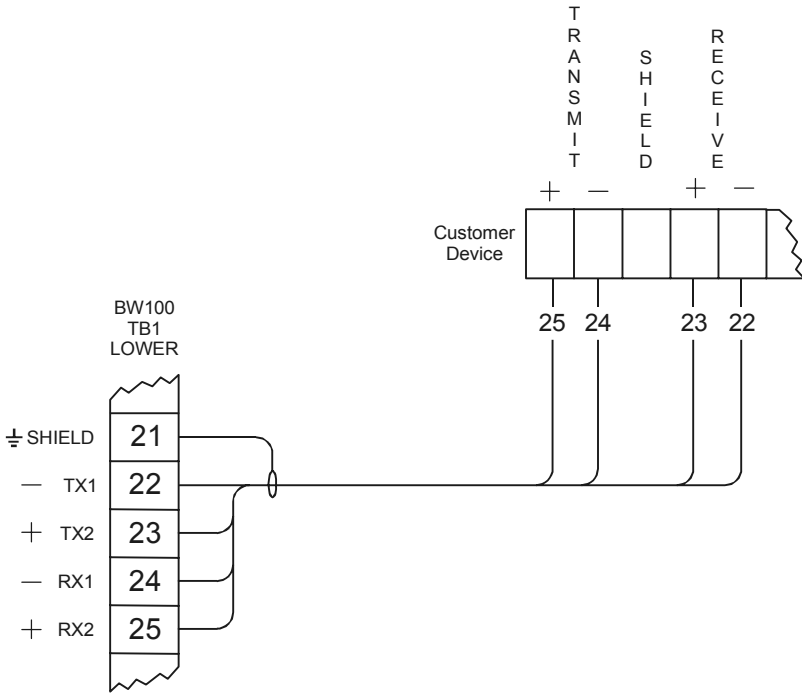

Connect shield at one device only, e.g. BW100 TB1 - 21

Maximum loop length 3000 m (10,000 ft.)

# Power Connections

## AC Power

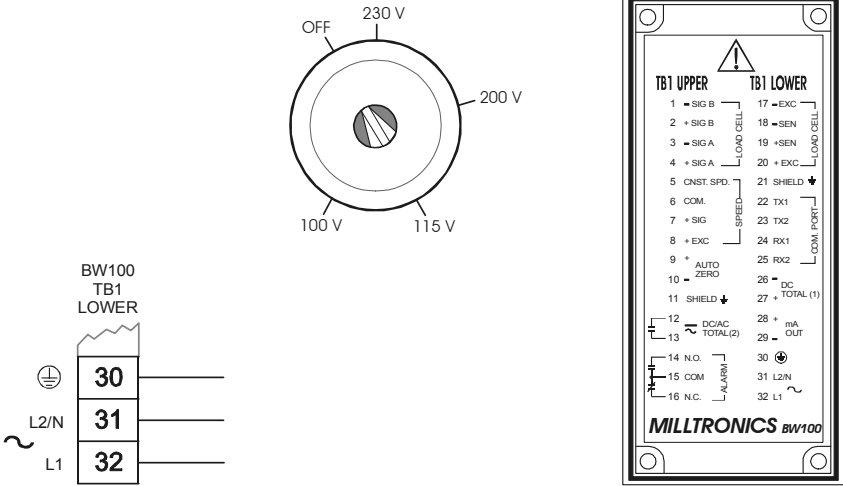

**Note:** The equipment must be protected by a 15 A fuse or a circuit breaker in the building installation.

A circuit breaker or switch in the building installation, marked as the disconnect switch, shall be in close proximity to the equipment and within easy reach of the operator.

Installation

## DC Power

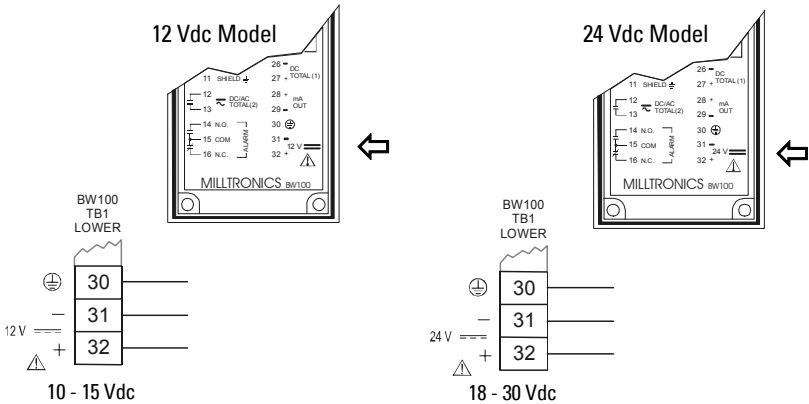

← dc model indicated on lid nameplate.

dc terminals shall be supplied from an SELV source in accordance with IEC-1010-1 Annex H.

# Converter

## Optional Dolphin Interface

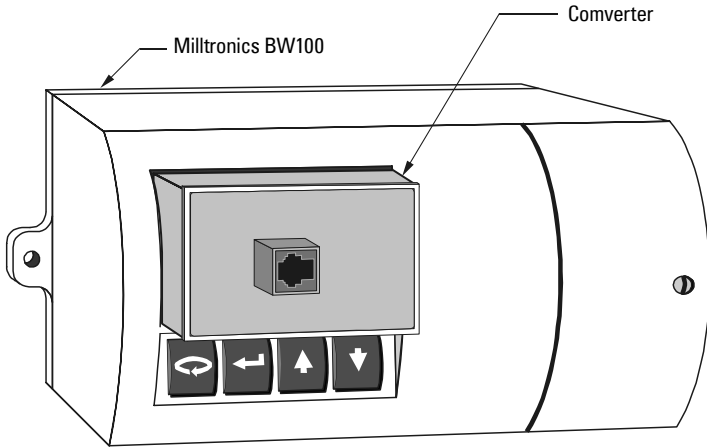

Refer to Dolphin instruction manual for interconnection details.

## Units Sticker

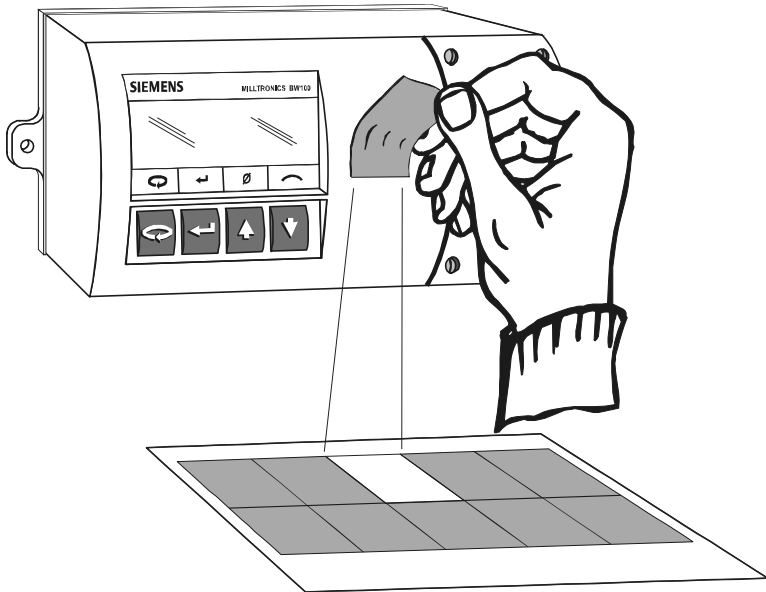

Remove the appropriate **units** sticker from the sheet supplied, and affix to your BW100 as shown.

# Start Up

**Note:** For successful start up, ensure that all related system components such as belt scale and speed sensor are properly installed and connected.

## Orientation

## Display and Keypad

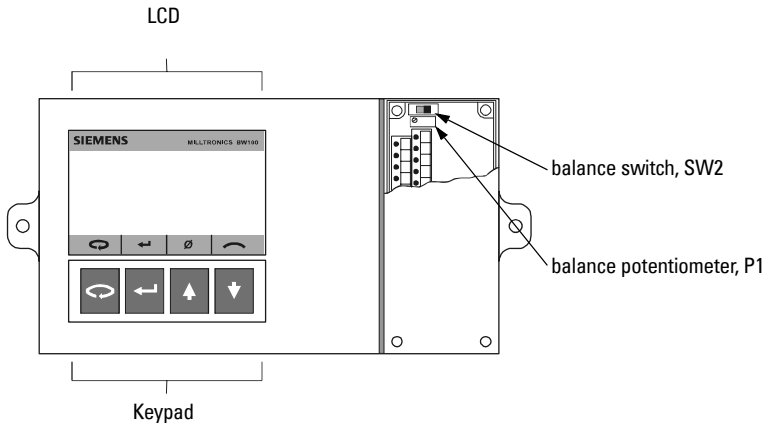

The BW100 operates under two modes: **RUN** and **PROGRAM**. When the unit is initially powered, it starts in the **PROGRAM** mode.

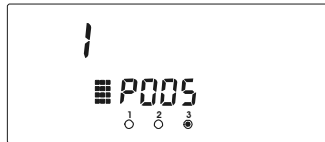

If the **PROGRAM** mode is idle, it reverts to the run mode after 10 minutes.

# PROGRAM Mode

LCD

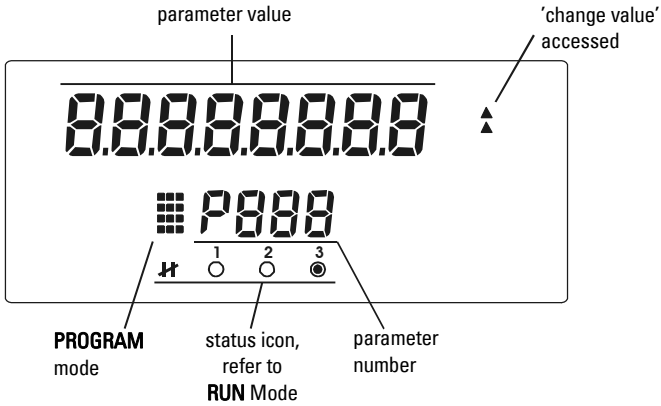

## KeyPad



access  
**RUN**  
mode



alternates  
**PROGRAM**  
mode between  
**select parameter**  
and **change value**



scroll  
up



scroll  
down

## Maneuvering

### To Select a Parameter:

if not in the **PROGRAM**  
mode

from the  
**RUN** mode

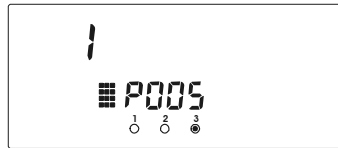
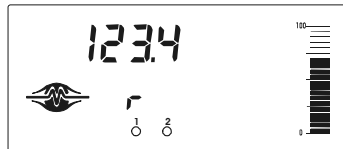

if in the **PROGRAM**  
mode

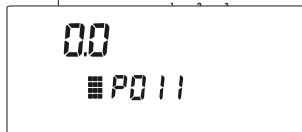
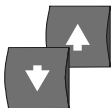

## Speed Scroll

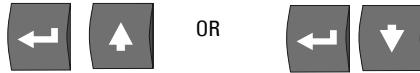

To speed scroll up or down press the up or down key and hold, then press the ENTER key and hold. Release to stop.

### To Change a Parameter Value:

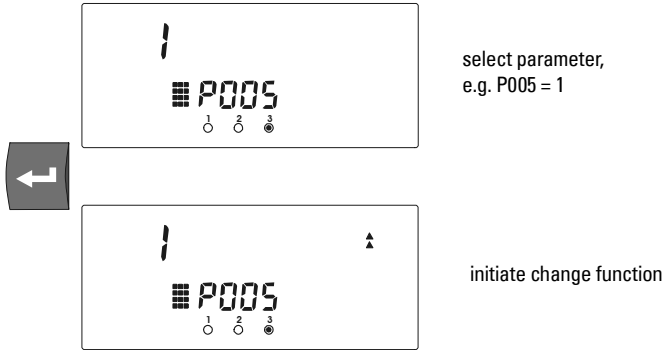

*security must be disabled*

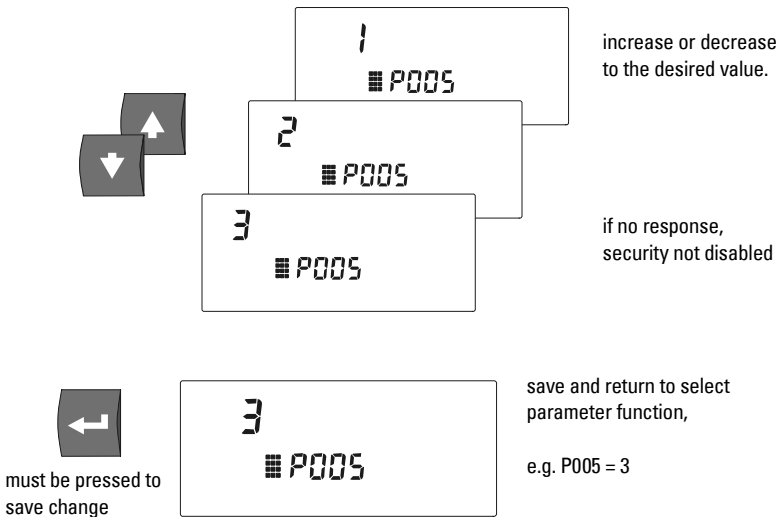

## Express:

### *Parameter*

to jump back to P005  
or

### *Value*

to jump to the factory setting



e.g. P999



jump back to P005

## To Access RUN Mode:



e.g. from the PROGRAM mode, P005

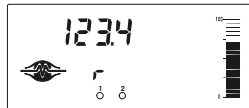

exit and return to **RUN** mode



## To Access the PROGRAM Mode:

from the run mode

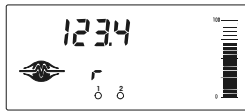

e.g. rate display



last parameter from previous PROGRAM session  
e.g. P005

## Master Reset

Prior to programming, balancing and calibration, a master reset of the BW100 should be done.

Refer to *Parameter P999* on page 64.

## Load Cell Balancing

If you are operating a two load cell belt scale, it is recommended that the load cells be balanced electronically prior to initial programming and calibration, or after either or both load cells have been reinstalled or replaced.

**Note:** Unbalanced load cells adversely affect the performance of your belt conveyor weighing system.

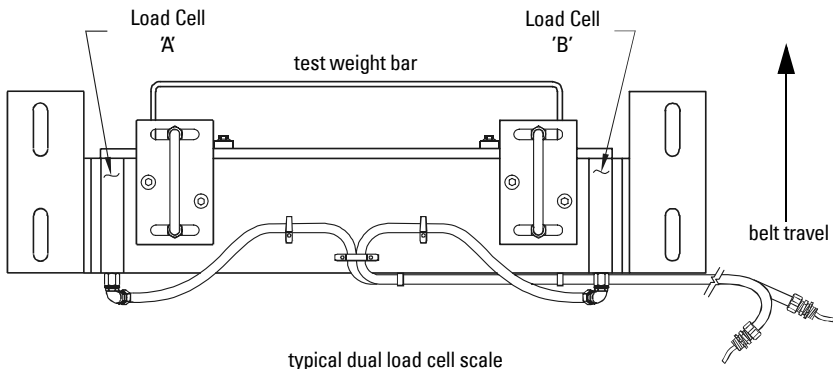

With the conveyor stopped and locked out, lift the belt off the weighing idlers.

Place the BW100 into the **PROGRAM** mode at P291.

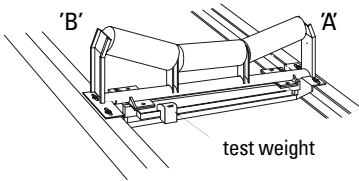

test weight on  
load cell **B** side

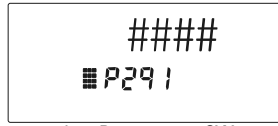

SW2

closed

select P291 ensure SW2  
is closed



SW2

open

enter and auto advance to P292,  
open SW2

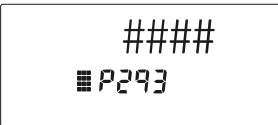

SW2

open

enter and auto advance to P293,  
leave SW2 open

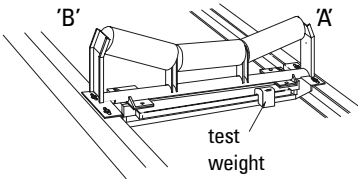

test weight on  
load cell **A** side



SW2

closed

enter and auto advance to P294,  
close SW2



P1

adjust until  
## = 0 +/- 5

enter and auto advance to P295

Remove the test weight, insure that the BW100 SW2 is in 'close' position and that P1 is left as set.

**Note:** Performing a balance procedure requires a subsequent zero and span recalibration.

# Quick Start

Quick Start parameters (P005 to P017) must be programmed for all applications.

Record parameter in Program Record on page 70.

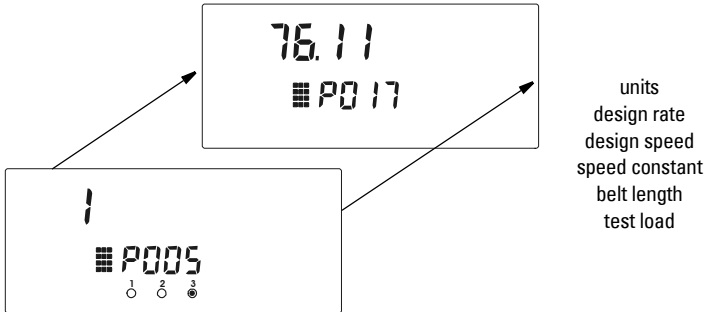

Upon completion of Quick Start programming, a Zero and Span calibration are required for successful entry into the **RUN** mode.

# Start Up

Program P005 - P017

refer to *Maneuvering* on page 18 for parameter selection and changing values.



program mode P005, units e.g. 1 mt/h

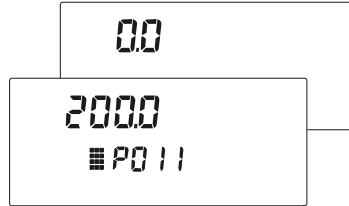

P011, design rate e.g. 200 t/h

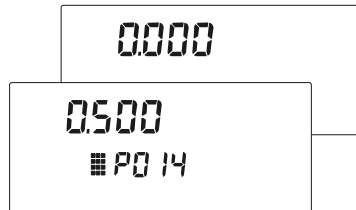

P014, design speed e.g. 0.5 m/s

▲ for constant speed applications, TB1 - 5/6 jumpered, value is locked at 100.

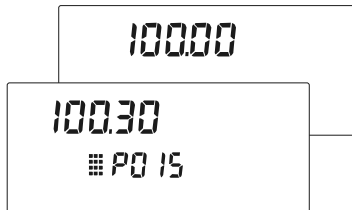

P015, speed constant ▲ e.g. 100.3 pulse / m

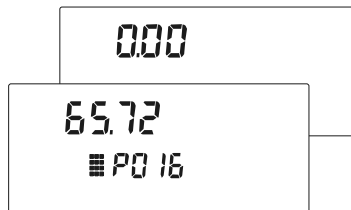

P016, belt length e.g. 65.72 m

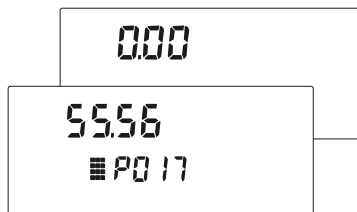

P017, test load e.g. 55.56 Kg / m

Examples are typical

Test load value should be less than design load (P952). If not, contact Siemens or their agent.

**Calibration Note:** The duration of Zero and Span Calibration is dependent upon speed (P014), length (P016) and revolutions (P360) of belt.

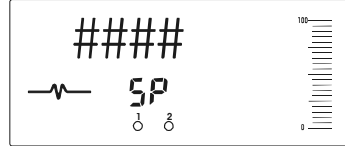
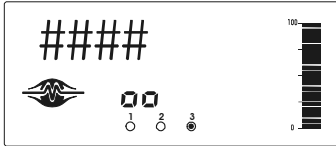

**Note:** To cancel a Zero or Span calibration in progress, press



# Zero Calibration

**Note:** Run the conveyor for several minutes to warm up the belt and insure that it is empty. Test weights are not used during a zero calibration.

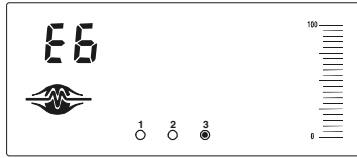

zero calibration required

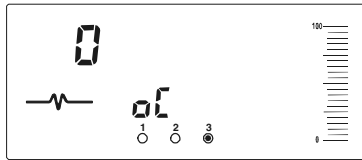

initial zero count

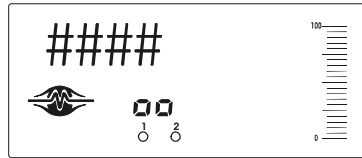

zero calculation,  
frequency count displayed

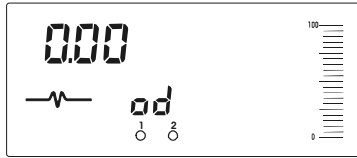

zero deviation calculated,  
initial deviation = 0

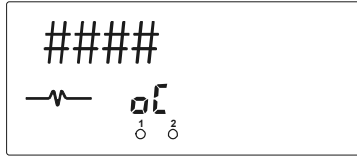

zero deviation accepted,  
initial zero count = ###  
**Record this value for future  
reference**

**Perform Span Calibration,**  
see next page

# Span Calibration

Run the conveyor until the belt is empty and stop it. Suspend the test weight from the scale per its instruction manual. Run the conveyor belt empty.

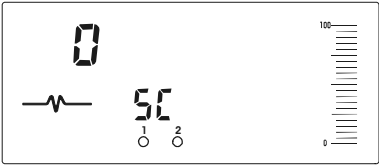
initial span count



span calculation,  
frequency count  
displayed

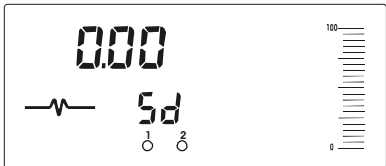

span deviation  
calculated  
initial deviation = 0

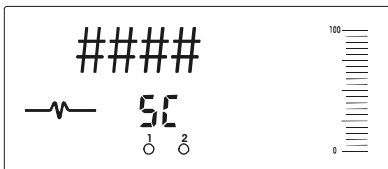
span deviation accepted  
initial span count = ####  
**Record this value for  
future reference**

Remove the test weight when the Span calibration is complete.

successful entry  
into run,  
display rate

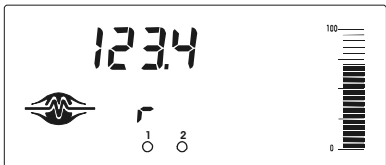
## RUN Mode

### LCD

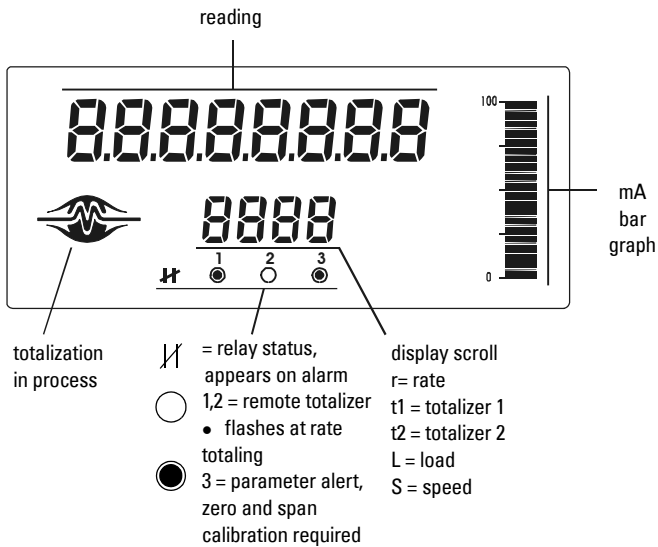

### Keypad

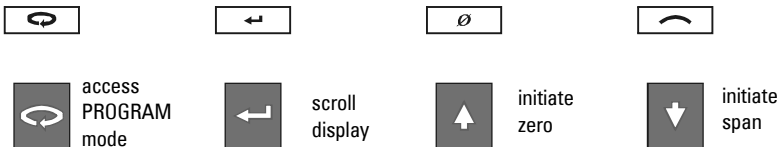

**Note:** The third status icon lights each time any of the basic Start Up parameters (P005 to P017) are accessed in edit mode, whether or not the parameters are modified. If this icon is lit (indicating calibration required) and the operator is confident that none of the basic Start Up parameters have been modified, cycling power to the BW100 will clear this icon.



# Recalibration

## Belt Speed Compensation

In order to achieve optimum accuracy in the rate computation, the belt speed displayed must equal that of the actual belt speed. As the speeds are likely to differ, a belt speed compensation should be performed.

Run the conveyor with the belt empty.

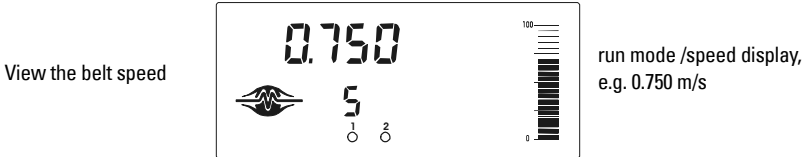

Stop the conveyor and measure a length of the belt; marking the forward end (start time) and the back end (stop time). Use the belt scale as the stationary reference.

Run the belt and measure the time for the belt length to pass over the scale.

$$\text{speed} = \frac{\text{belt length}}{\text{time}} \quad \begin{matrix} \text{m or ft.} \\ \text{s min.} \end{matrix}$$

Refer to *Maneuvering* on page 18 for parameter selection and value change.

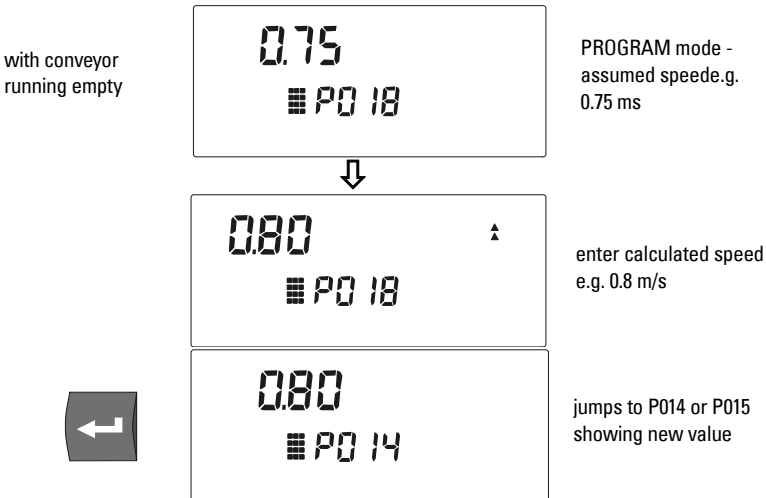

If the BW100 constant speed input (TB1-5/6) is jumpered, the design speed (P014) is automatically adjusted.

If a speed sensor is connected, the speed constant (P015) is automatically adjusted.

The display speed (used in the rate computation) now equals the actual speed.

Record the new value in Appendices/Program Record.

# Material Tests

Perform material tests to verify the accuracy of the of the span calibration. If the material tests indicate a repeatable deviation exists, a manual span adjust (P019) is then performed. This procedure automatically alters the span calibration and adjusts the test load (P017) value, yielding more accurate span recalibrations.

**Note:** Test weights are NOT used during material tests.

1. Run the belt empty.
2. Perform a zero calibration.
3. Put the BW100 into **RUN** mode
4. Record the BW100 total as the start value \_\_\_\_\_
5. Run material at a minimum of 50% of design rate over the belt scale for a minimum of 5 minutes.
6. Stop the material feed and run the conveyor empty.
7. Record the BW100 total as the stop value \_\_\_\_\_
8. Subtract the start value from the stop value to determine the BW100 total
9. Weigh the material sample if not already known.

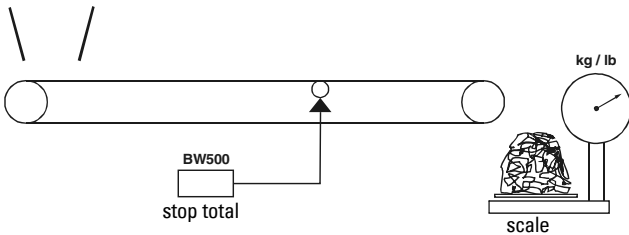
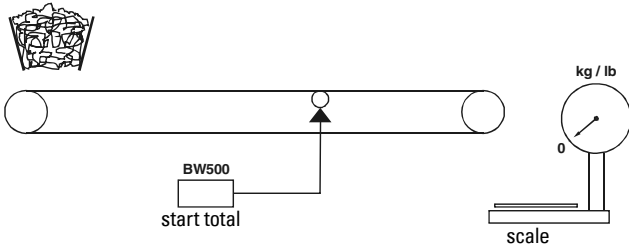

BW100 total = \_\_\_\_\_

material sample weight = \_\_\_\_\_

- Calculate the span adjust value:

$$\% \text{ span adjust} = \frac{\text{BW100 total} - \text{material sample weight}}{\text{material sample weight}} \times 100$$

If the span adjust value is within the accuracy requirements of the weighing system, the material test was successful and normal operation can be resumed.

If the span adjust value is not acceptable, repeat the material test to verify repeatability. If the result of the second material test differs considerably, consult Milltronics or its agent.

If the span adjust values are significant and repeatable, perform a manual span adjust:

refer to *Maneuvering*,  
page 18 for  
parameter selection  
and value change

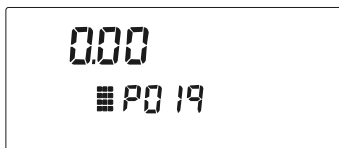

PROGRAM  
mode,  
P019

if % span adjust is  
negative, be sure  
to enter as  
negative value

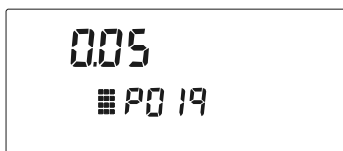

enter %  
span adjust,  
e.g. 0.05

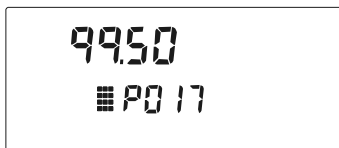

jumps to P017 adjusted  
test load, e.g. 97.95

Verify the results of the span adjust by material test or return to normal operation

## Design Changes

Where parameters have been changed with a resultant impact on the calibration or do not take effect until a recalibration is done, the parameter warning icon is displayed. In order to clear the icon, perform a zero and span recalibration after the reprogramming session is complete.

If significant changes have been made, an initial zero (P377) and/or initial span (P388) may be required.

## Recalibration

In order to maintain the accuracy of the weighing system, periodic zero and span recalibrations are required. Recalibration requirements are highly dependent upon the severity of the application. Perform frequent checks initially, then as time and experience dictate, the frequency of these checks may be reduced. Record deviations for reference.

# Routine Zero

Run the conveyor empty for several minutes to warm up the belt and insure that it is empty. Test weights are not used during a zero calibration.

From the run mode

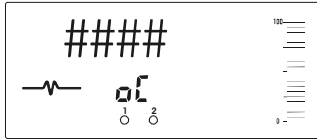

initiate zero calibration  
current zero count = ####



zero calculation,  
load value displayed



zero deviation calculated

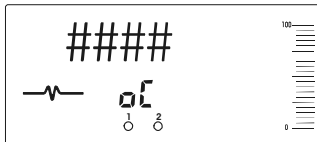

accept deviation  
new zero count = ####

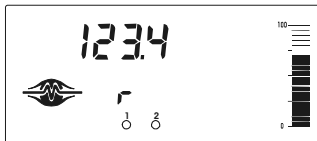

return to run mode

**Note:** E3 is an indication that the mechanical system is errant. The use of P377, *initial zero*, should be used judiciously and only after a thorough mechanical investigation has been exercised.

The cause of the increased deviation must be found and rectified. A zero recalibration as previously described can then be retried.

If the operator deems this deviation to be acceptable, set P377 to 1 to invoke an initial zero calibration. Further deviation limits are now based on this new initial zero.

# Initial Zero

Perform an initial zero if necessary when a **calibration is out of range** message is shown. Refer to *Maneuvering* on page 18 for parameter selection and value change.

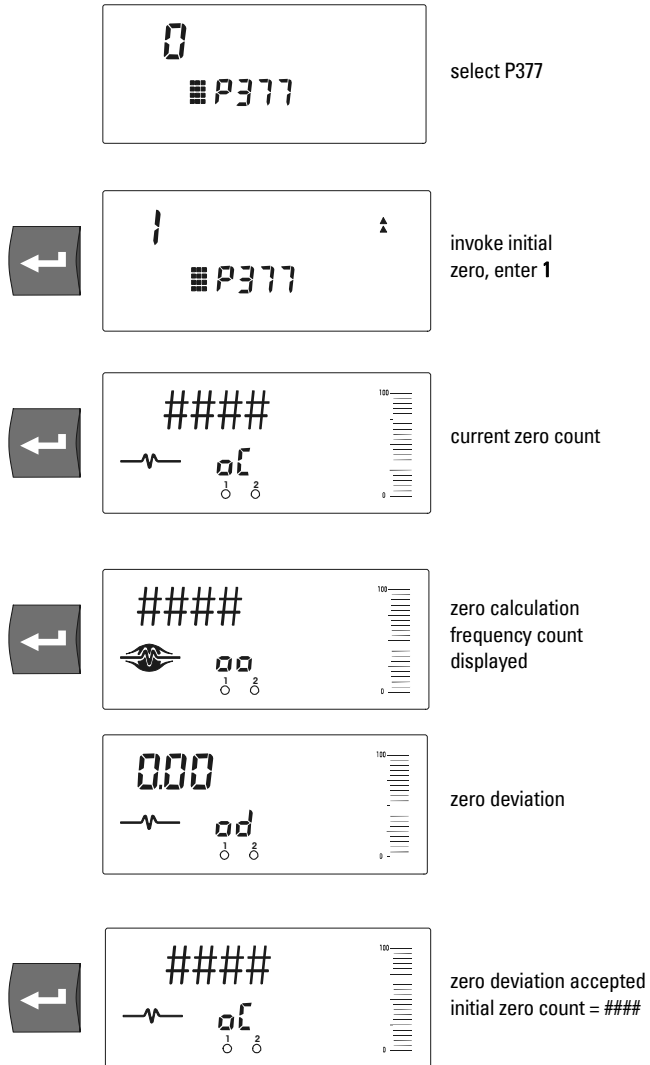

Perform Initial Span

# Direct Zero

Use direct zero entry (P367) when replacing software or hardware, if it is not convenient to perform an initial zero. A record of the last valid zero count is required.

Refer to *Maneuvering* on page 18 for parameter selection and value change.

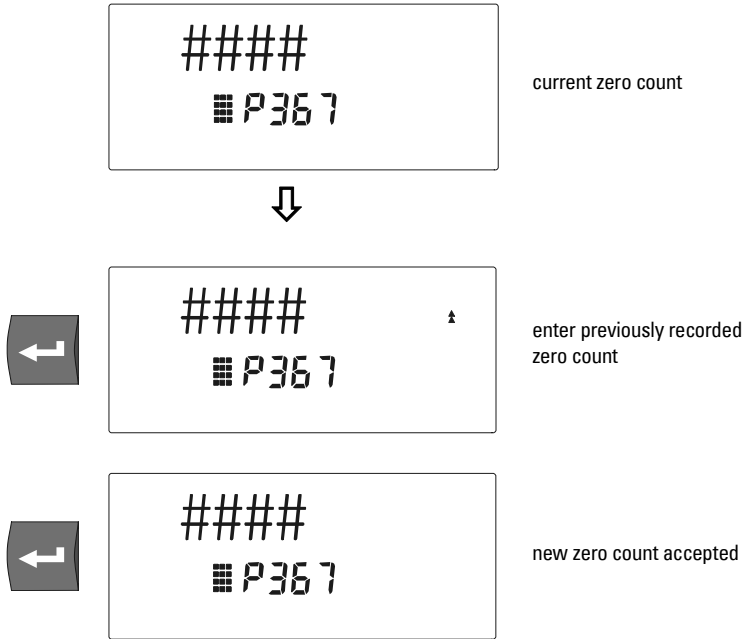

# Routine Span

To perform a routine span recalibration, run the conveyor until the belt is empty and stop it. Suspend the test weights from the belt scale per its instruction manual.

Run the conveyor empty at maximum operating speed.

From the zero calibration

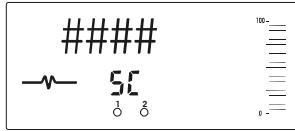

Initiate span calibration  
current span count = ####

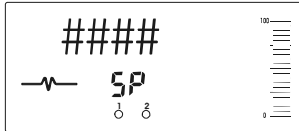

span calculation,  
load value displayed

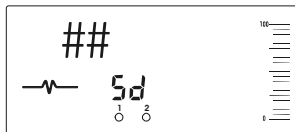

span deviation = ##

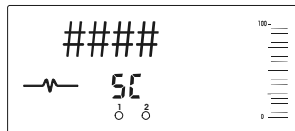

accept deviation  
new span count = ####

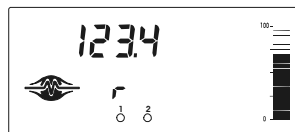

return to run mode

## Notes:

- E6 is a reminder that a zero calibration is strongly suggested before a span calibration is initiated. Press ENTER to bypass this message.
- E4 is an indication that the mechanical system is errant. The use of P388, initial span, should be used judiciously and only after a thorough mechanical investigation has been exercised.

The cause of the increased deviation must be found and rectified. A span recalibration as previously described can then be retried.

If the operator deems this deviation to be acceptable, set P388 to 1 to invoke an initial span calibration. Further deviations are now based on this new initial span.

**Note:** Remove the test weight when the span calibration is complete.

# Initial Span

**Note:** Perform an initial span when a **calibration out of range** message appears.

Refer to *Maneuvering* on page 18 for parameter selection and value change.



select P388

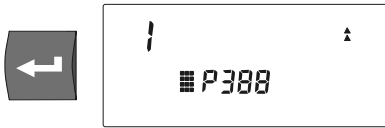

invoke initial span

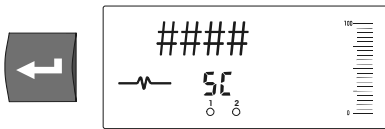

current span count = ####

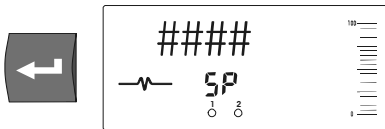

span calculation,  
frequency count displayed

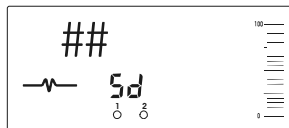

span deviation = ##

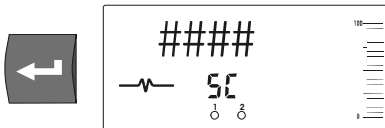

span deviation accepted  
initial span count = ####

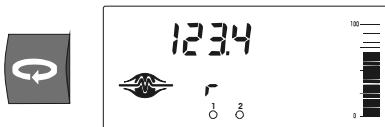

return to run mode



# Direct Span

Direct span entry (P368) is intended for use when replacing software or hardware, and when it is not convenient to perform an initial span. A record of the last valid span count is required.

Refer to *Maneuvering* on page 18 for parameter selection and value change.

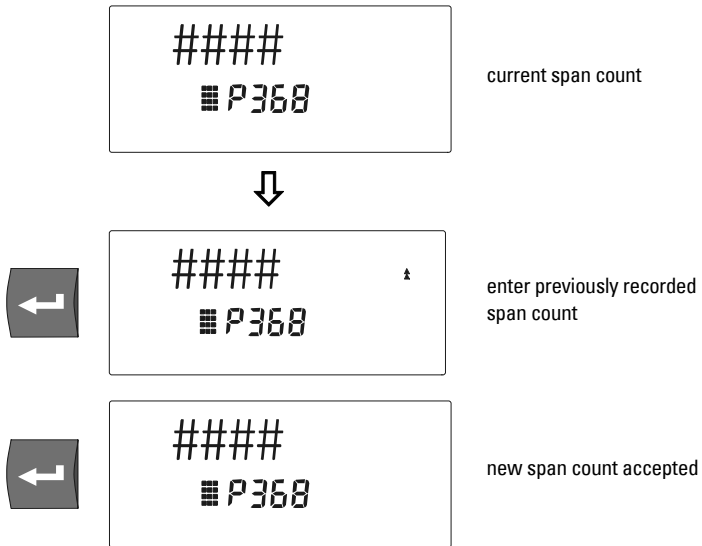

# Factoring

In order to calculate the value of a new or unknown test weight to the current span, the factoring procedure is used.

**Note:** For optimum accuracy in the factoring results, a routine zero calibration is recommended.

Refer to *Maneuvering* on page 18 for parameter selection and value change.

With the conveyor stopped and the belt empty:



P359 selected



enter



hang new test weight onto belt scale, then run the conveyor empty

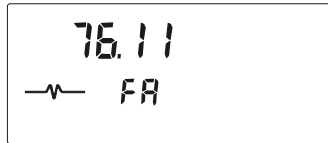

initiated Factoring,  
current test load value  
e.g. 76.11 kg / m



dynamic test load value  
e.g. 76.03 kg / m



jumps to P017  
dynamic test load value  
e.g. 76.03 kg / m

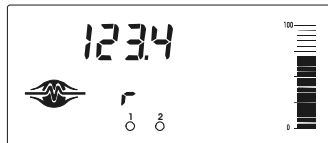

return to run mode

# Linearization

Conveyor applications where the belt scale is poorly located, or where there is a high degree of variation in belt tension, typically cause the belt scale to report load non-linearly. The BW100 provides a linearizing function (P390 - P396) in order to correct for the deficiency in the weighing system and to provide an accurate report of the actual process.

## To verify that the cause of the non-linearity is not mechanical:

1. Run the conveyor belt empty and stop it.
2. Suspend various test weights to the scale to verify mechanical linearity. If the load reported by the BW100 at these tests is non-linear, a mechanical problem is indicated. Refer to the belt scale manual in order to resolve the non-linearity by improved installation or repair.

## If it is determined that the non-linearity is due to the weighing application, and not the actual belt scale, apply linearization by performing the following:

- zero calibration
- span calibration at 90 to 100% of design rate
- material tests at 90 to 100% of design rate
- manual span adjust if required
- material tests at 1 to 3 intermediary flow rates where compensation is required.

### Notes:

- Compensation points must be at least 10% of the design load apart.
  - E8 message occurs if a point is less than 10% of full scale or if points are less than 10% apart.
- 
- calculate the percentage compensation for each flow rate tested.  
% compensation =  $\frac{\text{actual weight} - \text{totalized weight}}{\text{totalized weight}} \times 100$

**Where:** actual weight = material test  
totalized weight = BW100 total

**Example:**

A non-linearity with respect to the ideal response exists in a belt scale application with design rate of 200 t/h. It is decided to do material tests at 25, 50 and 75% of the design rate. After performing a zero and a span calibration at 100% of the design rate, followed by material tests and manual span adjust, three material tests were performed at 50, 100 and 150 t/h, as indicated by the BW100. The following data was tabulated. (This example is exaggerated for emphasis).

The material tests should be run at same belt speed, representative of normal operation; in this case 1.2 m/s. For each rate, record the corresponding load value by scrolling to the BW100 load display during running conditions or by calculation.

$$\text{load} = \frac{\text{rate}}{\text{speed}}$$

BW100 load kg/m	material test tonnes	BW100 total tonnes	compensation* %
11.6	4.2	4.9	-14.3
23.2	8.4	7.6	10.5
34.7	12.6	13.7	-8.0

\*calculation example: % compensation =  $\frac{4.2 - 4.9}{4.9} \times 100$   
 = - 14.3

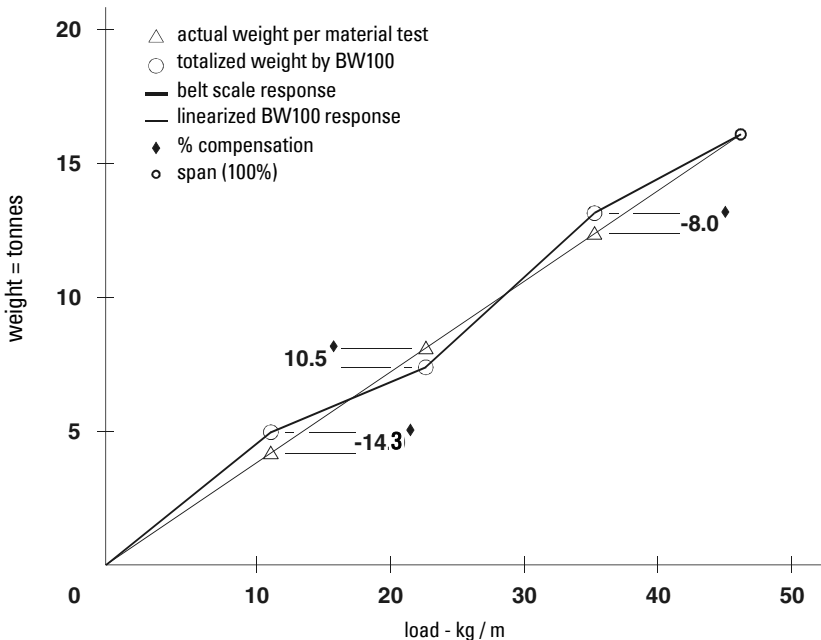

Program the BW100 as follows:

P390 = 1  
 P391 = 11.6  
 P392 = -14.3  
 P393 = 23.2  
 P394 = 10.5  
 P395 = 34.7  
 P396 = -8

Often only one point of compensation is required, usually at a low load value. In the prior example, if compensation was only required at 11.6 kg/m, the programming could be as follows. Compensation is optimized by establishing the next load value that agrees with the material test, hence where compensation is zero and entering it as the next compensation point.

P390 = 1  
 P391 = 11.6  
 P392 = -14.3  
 P393 = 23.2  
 P394 = 0  
 P395 = 34.7  
 P396 = 0

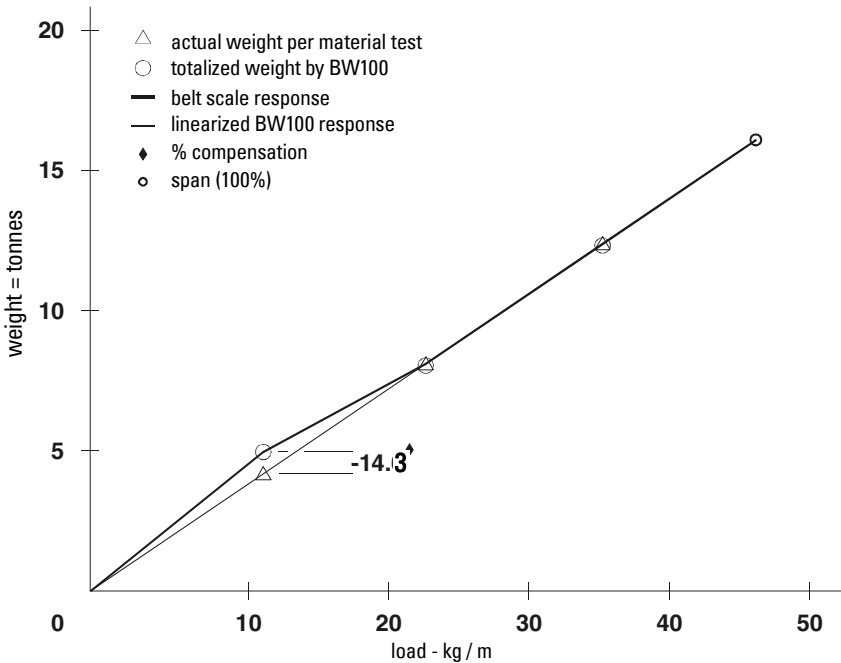

# Operation

---

## Load Sensing

In order for the BW100 to calculate rate and hence totalize material flow along the belt conveyor, a load signal representative of weight of material on the belt is required. The load signal is provided by the belt scale. The BW100 is compatible with belt scales fitted with one or two strain gauge type load cells.

Refer to *Specifications* on page 3 and *Installation/Load Cell* on page 6 for belt scale requirements and connection.

## Speed Sensing

In order for the BW100 to calculate rate and hence totalize material flow along the belt conveyor, a speed signal representative of belt speed is required. In constant speed applications (no speed sensor), the BW100 can be programmed to provide an internal speed signal. This is achieved by entering the design speed (P014) and providing a jumper across speed input terminals (TB1-5/6). Speed constant (P015) defaults to 100.

For optimum accuracy of the weighing system, both constant and variable speed applications, a speed sensor is required. Again, the design speed and speed constants need to be programmed, however the jumper across the speed input has to be removed and the speed sensor connected.

Refer to *Specifications* on page 3 and *Installation/Speed Sensor* on page 6 for speed sensor requirements and connection.

## Modes of Operation

**RUN** is the normal or reference mode of operation. It continuously processes the load signal from the belt scale to produce internal load and rate signals, which are in turn used as the basis for totalization, mA output and relay control. The **RUN** display is programmed (P081) to scroll through rate, totalization, load and speed; either manually by pressing the ENTER key, or automatically. A bar graph is continuously displayed. It is proportional to the analog output as programmed (see *Analog Output* on page 43).

From the **RUN** mode, access to the **PROGRAM** mode on and zero and span calibration is made.

The **PROGRAM** mode allows viewing and, with security permission (P000), changing parameter values. During **PROGRAM**, **RUN** mode functions are still active, i.e.: rate, relay, analog output and totalization. Error interrupts are suppressed and the bar graph is disabled.

If the **PROGRAM** mode is left idle for a period of ten minutes, it automatically reverts to the **RUN** mode.

## Damping

Damping (P080) controls the speed at which the displayed readings and output functions respond to changes in their respective input function; load, speed and the internal rate signals. Changes in the displayed rate of material flow, material loading and belt speed are controlled by the damping. Relay alarm functions based on input functions of flow, load and speed, respond to the damped value.

If the specific mA output damping parameter (P220) is enabled (value other than 0), then the damping (P080) as it pertains to the mA function is overridden, and the output value and bar graph respond independently at the specified mA output damping rate (P220).

## Analog Output

The BW100 provides one isolated analog output. The output can be assigned (P201) to represent rate, load or speed. The output range can be set to 0 - 20 mA or 4 - 20 mA (P200). The 0 or 4 mA value corresponds to empty or zero condition, whereas the 20 mA value corresponds to the associated design value: rate (P011), load (P952) or speed (P014). The analog output can be limited for over range levels of 0 mA minimum and 22 mA maximum (P212 and P213 respectively). The output 4 and 20 mA levels can also be trimmed (P214 and P215 respectively) to agree with a millammeter or other external mA input device.

The BW100 LCD provides a bar graph as a function of analog output. It displays the mA value as percentage of the mA range.

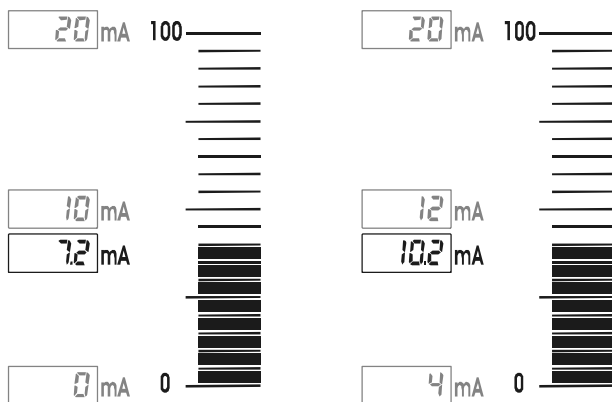

The mA output value can be tested using parameter P911. Refer to *Parameter P911* on page 62.

# Relay Output

The BW100 offers one single pole double throw (SPDT) relay that can be assigned (P100) to one of the following alarm functions:

- rate: relay alarms on high and/or low material flow rate.
  - auto zero: relay alarms when an attempted auto zero calibration reports an out of range condition (E9).
  - speed: relay alarms on high and/or low belt speed.
  - load: relay alarms on high and or low belt load.
  - error: relay alarms on any error condition as it is reported.
- Refer to *Troubleshooting*, page 65.

Except for alarm on 'auto zero' and 'error', the high and low alarm setpoints (P101 and P102 respectively) are required and must be entered in the appropriate units.

The on / off actuation at both setpoints is buffered by the damping (P080) and the programmable dead band (P117), to prevent relay chatter due to fluctuations. The relay is normally energized; i.e. the normally closed (n.c.) contact held open. Upon an alarm condition, the relay is de-energized and the alarm icon on the BW100 display appears. Once in alarm, the relay and icon remain in alarm status until the alarm condition is removed.

**Example:**

- P014 = 2m/s, design speed
- P100 = 3, belt speed
- P101 = 100% (2m/s)

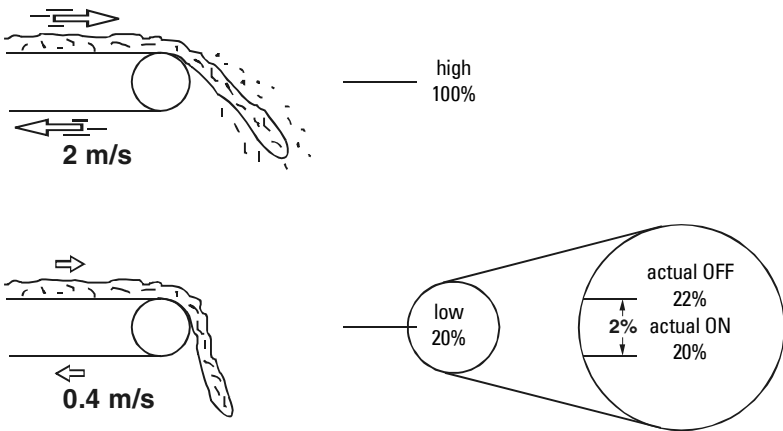

alarm **ON** is with relay de-energized



# Totalization

The totalization function is based on the internal rate (mass per unit time) signal proportional to belt speed and load on the associated belt scale. It is not affected by the damping function (P080). The rate signal is sampled several times a second to accurately count the mass of material conveyed. The count is held in the master totalizer used to increment the internal totalizers and to produce a pulse signal for the remote totalizers.

The BW100 provides four separate totalizer functions:

- internal totalizer 1
- internal totalizer 2
- remote totalizer 1
- remote totalizer 2

To avoid totalizing material at low flow rates, the totalizer drop out limit (P619) is set to a percentage of the design rate. Below this limit, totalization stops. When material flow returns to a rate above the drop out limit, totalization resumes.

Totalizer resolution or count value is set by the respective control parameters, P631 -- P639. If the resolution selected causes the totalizer to lag behind the count rate, an E2 error is displayed after making the parameter entry. The error is rectified by selecting a greater resolution value.

### Example: Internal totalizer 1

**Given:** P005 = 1 (t/h)  
P631 = 4

**Then:** totalizer count increments by 1 for each 1 metric tonnes registered

### External totalizer 1

**Given:** P005 = 1 (t/h)  
P638 = 5

**Then:** contact closure occurs once for every 10 metric tonnes registered

For remote totalization, the contact closure duration is set by the respective control parameters, P643 and P644. The value is automatically calculated upon entry of the design rate (P011) and remote totalizer parameters (P638 and P639), so that the duration of contact closure allows the relay response to track the total up to 150% of the design rate. The value can be changed to suit specific contact closure requirements, such as in the case of programmable logic controllers. If an E2 error is displayed, P638 or P639 has to be increased.

### External Totalizer Resolution Calculation Example:

Design Rate = 50 t/h (P011)

External Totalizer Resolution selected = 0.001 (P638 or P639 = 1)

External Totalizer Contact Closure Time selected = 32 msec (P643 or P644 = 1)

External Totalizer Cycle Time = 64 msec (External Totalizer Contact Closure Time X 2)

1 - Calculate the maximum number of pulses per second for the Contact Closure Time selected (P643 or P644)



$$\begin{aligned} \text{Maximum Number of pulses per second} &= 1 / \text{External Totalizer Cycle Time} \\ &= 1 / 0.06 \\ &= 15.6 \text{ (which is rounded to a whole} \\ &\quad \text{number in the BW100 to 15)} \end{aligned}$$

2 - Calculate the pulses per second required for the External Totalizer Resolution selected (P638 or P639)

$$\text{Pulses Per Second} = \frac{\text{Design Rate X 150\%}}{\text{External Totalizer Resolution X 3600}} = \frac{50 \text{ t/h X 150\%}}{0.001 \text{ X 3600}} = 20.83$$

Because the required 20.83 pulses per second is greater than the maximum 15 pulses per second, the External Totalizer Resolution of 0.001 will not allow the External Totalizer to track up to 150% of the design rate. The External Totalizer Resolution will have to be increased to 0.01.

The totalizers are reset through the master reset (P999), the totalizer reset (P648) or through the keypad.

- master reset: the reset of all totalizer functions is included in the master reset.
- totalizer reset: totalizer reset can be used to resets internal totalizers 1 and 2, or totalizer 2 independently.
- keypad: pressing   simultaneously while in the **RUN** mode resets internal totalizer 1, as well as the internal counts for both remote totalizers.

Placing the internal totalizers on to the display scroll of the **RUN** mode is controlled by the totalizer display parameter (P647); displaying either one or both totalizers.

## Auto Zero

The Auto Zero function allows a zero calibration to be initiated automatically under the following conditions.

- the auto zero input (TB1-9/10) is in a closed state; jumper or remote switch
- the load is less than 2% of the design load

If the resulting zero deviation is less than an accumulated 2% from the last operator initiated zero, the auto zero is accepted.

If the deviation is greater than an accumulated 2%, an E9 error is displayed and the relay, if so programmed, goes into alarm (refer to *Operation/Relay Output*, page 44). The E9 error is cleared after five seconds.

If material feed resumes during an auto zero function, the totalizing function is maintained.

# Communications

The BW100 bipolar current loop provides long distance communication to a customer device.

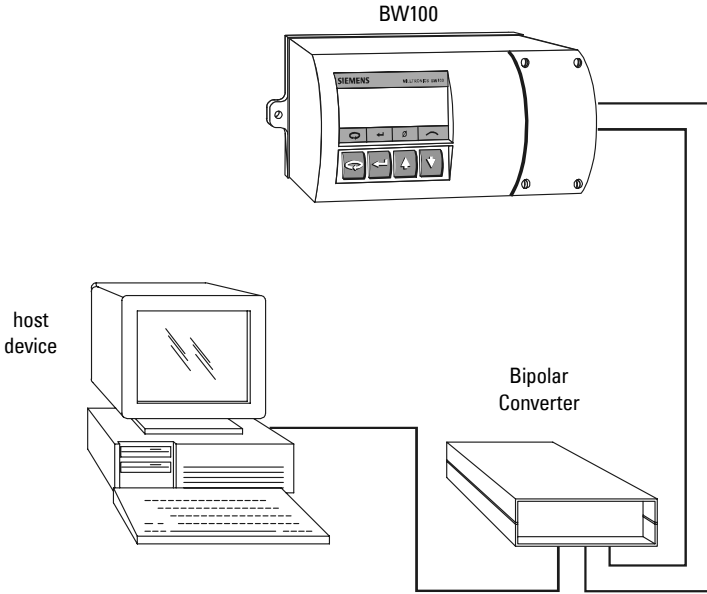

The BW100 communication port (TB1-21 to 25) is software set for baud (P751) and mode enable (P760). Refer to *Installation/Communication* on page 14 for wiring details.

**Note:** If communicating via Milltronics Dolphin software, the baud rate must be set to **4800**.

## Protocol

Protocol refers to the format, sequence and value of the data fields used in communication messages. Each data field of a BW100 message contains one or more bytes of ASCII binary code.

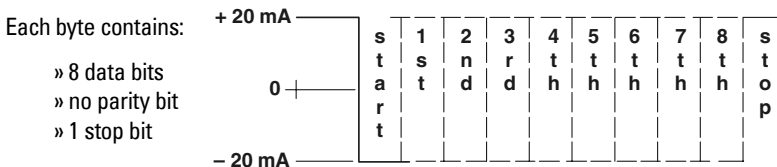

# Data Field Descriptions

The following data fields are used.

som

BW100 start of message, ASCII character = STX (Hex Value = 02).

DEVICE

Identifies the BW100 to which the message applies. The device is a 2 character number that equals the Unit I.D. code, (P761). ASCII characters = 00 to 15.

MT

Identifies the 2 character message type transmitted, ASCII characters:

- 50 = material flow rate
- 51 = material load
- 52 = belt speed
- 53 = totalizer 1, internal
- 54 = totalizer 2, internal

READING

Contains the measurement value in the engineering units of measure selected during BW100 programming. The number of bytes in this data field varies dependent upon the reading value. Up to 8 ASCII characters including the decimal point may be transmitted.

UNITS

Three ASCII characters identify the totalizer engineering units (MT=53 and MT=54). The first character is always a space. The remaining characters may be:

- t = tonnes
- T = tonnes
- LT = long tonnes
- kg = Kilograms
- lb = pounds

eom

BW100 end of message, ASCII character = CR (Hex Value = 0D).

## Message Requests

Message requests must be transmitted from the host to the BW100 in the following format.

som DEVICE MT eom

**Example:**

Data Field	ASCII Character	Example Description
som	STX	start of message
DEVICE	01	for BW100 # 1
MT	50	material flow rate request
eom	CR	end of message

# Message Responses

The BW100 response to a flow rate (MT=50) load (MT=51) or speed (MT=52) message request is in the following format.

som DEVICE MT READING eom

## Example:

Data Field	ASCII Character	Example Description
som	STX	start of message
DEVICE	00	from BW100 # 0
MT	50	material flow rate response
READING	392.5	is 392.5
eom	CR	end of message

The response to a material total (MT=53) message request is in the following format.

som DEVICE MT READING UNITS eom

## Example:

Data Field	ASCII Character	Example Description
som	STX	start of message
DEVICE	01	from BW100 # 1
MT	53	material total response
READING	129.2	is 129.2
UNITS	t	metric tonnes
eom	CR	end of message

# Parameters

---

**Note:** *f* denotes factory default.

## P000 Security lock

Locks out the programming **change value** function such that the values of P001 through P999 cannot be changed. This however does not prevent the **select** function from use; i.e. for viewing values.

Programming is locked out if the value of P000 is other than 1954.

### Entry:

1954 = unlocked<sup>*f*</sup>

~~1954~~ = locked

## Quick Start (P005 to P017)

**Note:** **Quick Start** is the minimum parameter programming required before attempting a calibration and successful entry into the **RUN** mode.

## P005 Design Rate Units

Determines the units for programming and measurement.

### Entry:

1<sup>*f*</sup> = mt/h (metric tonnes per hour)

2 = kg/h (kilograms per hour)

3 = LT/h (long tons per hour)

4 = T/h (short tons per hour)

5 = lb/h (pounds per hour)

Changing this parameter does not affect the rate (P011), belt speed (P014) or belt length (P016) parameters. These parameters should be re-entered for conformity in units.

t = 1000 kg

LT = 2240 lb.

T = 2000 lb.

## P011 Design Rate

Specifies the design rate of material flow for the belt scale.



## P018 Speed Constant Adjust

This parameter allows adjustment to the speed constant (P015).

Initially, this parameter displays the dynamic speed of the belt. If the displayed speed is not equal to the actual speed, enter the actual belt speed.

For speed sensor applications, the value of P015 is automatically adjusted.

For constant speed (TB1 5/6 jumper) the value of P014 is automatically adjusted.

## P019 Manual Span Adjust

This parameter allows adjustment to the span calibration.

The adjustment value is generally determined by performing material tests. Refer to *Recalibration/Material Tests*, page 30.

Enter the calculated adjustment.

## P022 Minimum Speed Frequency

Sets the minimum frequency that the speed sensor can reliably read. Signals at low frequencies are erratic, adversely affecting the performance of the weighing system.

### Entry:

1 = 1 Hz (at 1 Hz, it takes 1 sec before defaulting to 0 speed)

2 = 2 Hz (at 2 Hz, it takes 0.5 sec before defaulting to 0 speed)

## P080 Damping

Sets the speed of response to which the displayed readings (rate, load and speed), and outputs (alarm and mA) react to change.

**Note:** The effect of damping (P080) on mA output can be overridden by mA output damping (P220).

The greater the damping value, the slower the response.

Enter damping value, range 1 - 9999.

## P081 Display Mode

Sets the display mode. Normally, the display shows rate, or the last manually selected function. If set to alternating, the display alternates between rate and totalizer (1 and/or 2, as programmed by P647).

### Entry:

0 = normal

1 = alternating



# Relay/Alarm Function (P100 - P117)

**Note:** These parameter are specific to the use of the relay/alarm function. Refer to *Operation/Relay Output*, page 13.

## P100 Relay Set Up

Sets the alarm mode for the relay.

**Entry:**

- 0 = off
- 1 = rate
- 2 = auto zero
- 3 = belt speed
- 4 = belt load
- 5 = error

## P101 High Alarm

Sets the high alarm setpoint for relay functions P100 = 1, 3 or 4.

Enter the value in % of full scale.

## P102 Low Alarm

Sets the low alarm setpoint for relay functions P100 = 1, 3 or 4.

Enter the value in % of full scale.

## P117 Alarm Dead Band

Sets the dead band to prevent relay chatter due to fluctuations at the high or low setpoint.

Enter the value in % of full scale

*End of relay/alarm parameters.*

## mA Output Parameters (P200 - P220)

**Note:** These parameters are specific to the use of the mA output. Refer to *Operation* on page 42 for details.

## P200 mA Range

Sets the range for the mA output.

### Entry:

1 = 0 - 20 mA

2 = 4 - 20 mA

## P201 mA Function

Assigns the mA output to track one of the integrator functions.

### Entry:

1 = rate

2 = load

3 = speed

## P212 mA Min Limit

Limits the lower mA range (0 or 4 mA) to a minimum output value.

Enter limit value, range 0 - 22.

## P213 mA Max Limit

Limits the upper mA range (20 mA) to a maximum output value.

Enter limit value, range 0 - 22.

## P214 4 mA Trim

Adjusts the 4 mA output level to agree with a milliammeter or other external mA input device.

Enter trim value, range 0 - 9999.

## P215 20 mA Trim

Adjusts the 20 mA output level to agree with a milliammeter or other external mA input device.

Enter trim value, range 0 - 9999

## P220 mA Output Damping

Sets the speed at which the mA output reacts to change.

The greater the damping value, the slower the response. If the value is 0, the mA output assumes the damping set in P080.

Enter the damping value, range 0 - 9999

*End of mA output parameters.*

# Load Cell Balancing Parameters (P291 - P295)

**Note:** These parameters are used for verifying or balancing the load cells (2) on the associated conveyor belt scale. Refer to *Start Up*, page 17, for details and procedure for use of these parameters.

## P291 Calculator Input 1

This register displays the count associated with the summation of load cell A and B signals, when balancing the A and B load cells of the associated belt scale.

## P292 Calculator Input 2

This register displays the count associated with the load B signal, when balancing the A and B load cells of the associated belt scale.

## P293 Calculator Input 3

This register displays the count associated with the load cell B signal, when balancing the A and B load cells of the associated belt scale.

## P294 Calculator Input 4

This register displays the count associated with the summation of load cell A and B signals, when balancing the A and B load cells of the associated belt scale.

## P295 Load Cell Balance

Used in conjunction with balance calculator parameters (P291 - P 294), this parameter displays the adjustment required to complete the load cell balance procedure.

*End of balancing parameters*

## P341 Run Time

The cumulative days that the application device has been in service. The time is recorded once daily in a non-resettable counter. Periods of less than 24 hr. are not recorded, nor accumulated.

## P350 Calibration Security

This parameter provides additional security to the global lock (P000).

### Entry:

0 = view parameters, perform zero and span, no reset of totalizer 1

1 = same as level 0, but cannot perform span

2 = same as level 0, but cannot perform zero and span

## P359 Factoring

Factoring is used as a method of calculating the value of the test load (P017) to a new physical test weight.

### Entry:

0 = idle

1 = factor

**Note:** Totalization is halted during the factoring procedure, and resumed only upon return to the **RUN** mode.

## P360 Calibration Duration

Sets the number of belt revolutions to use during a zero or span calibration.

Enter number of belt revolutions, range 1 - 99.

## P367 Direct Zero

This parameter allows the zero reference count to be viewed or entered directly.

Direct entry is intended for use when replacing software or hardware and it is not convenient to perform an initial zero at that time.

## P368 Direct Span

This parameter allows the span reference count to be viewed or entered directly.

Direct entry is intended for use when replacing software or hardware and it is not convenient to perform an initial span at that time.

## P370 Zero Limit

Sets the zero calibration deviation limit from the last initial zero. If the accumulated deviation exceeds the limit, the zero calibration is aborted (E3).

### Entry:

0 = +/- 12.5% of initial zero

1 = +/- 2% of initial zero

## P377 Initial Zero

The initial zero is the reference zero to which all subsequent operator initiated zero calibrations are compared in determining whether they have deviated beyond the zero limit (P370).

### Entry:

0 = idle  
1 = initial zero

**Note:** Refer to *Recalibration/Initial Zero* on page 33 for use of this function.

## P388 Initial Span

The initial span is the reference to which all subsequent span calibrations are compared in determining whether they have deviated beyond 12.5% of the initial span.

### Entry:

0 = idle  
1 = initial span

**Note:** Refer to *Recalibration/Initial Span* on page 36 for use of this function.

## Linearization Parameters (P390 - P396)

**Note:** These parameters are used to compensate for non-linear response of the weighing system to the BW100. Refer to *Recalibration/Linearization* for details and example on the use of these parameters.

### P390 Linearization

Enables or disables the linearization function.

### Entry:

0 = OFF  
1 = ON

### P391 Linearizer, Point 1

Enter the load, in units of P017, for point 1

### P392 Compensation, Point 1

Enter the calculated compensation, in percent, for compensation point 1

## P393 Linearizer, Point 2

Enter the load, in units of P017, for point 2.

## P394 Compensation, Point 2

Enter the calculated compensation, in percent, for compensation point 2.

## P395 Linearizer, Point 3

Enter the load, in units of P017, for point 3.

## P396 Compensation, Point 3

Enter the calculated compensation, in percent, for compensation point 3.

*End of Linearization Parameters.*

## Totalization (P619 - P648)

The following parameters are specific to the use to the BW100 totalizers. Refer also to *Operation/Totalization*, page 45.

**Note:** If the resolution (P631 - P639) selected would cause the totalizer to lag behind the count rate, a message E2 is displayed after making the entry.

Select a greater resolution value.

### Example

**Given:** P005 = 1 (t/h)  
P631 = 5

**Then:** totalizer count increments by 10 for each 10 metric tonne registered

## P619 Totalizer Drop Out

This parameter sets the limit, in percent of design rate, below which material rates are not totalized.

The value of **0** is reserved to allow both negative and positive totalization.

Enter drop out value in % of design rate.

## P631 Totalizer 1 Resolution, Internal

This parameter sets the resolution of internal totalizer 1.

### Entry:

- 1 = 0.001 (one thousandth)
- 2 = 0.01 (one hundredth)
- 3 = 0.1 (one tenth)
- 4 = 1 (unit)
- 5 = 10 (x ten)
- 6 = 100 (x hundred)
- 7 = 1000 (x thousand)

## P632 Totalizer 2 Resolution, Internal

This parameter sets the resolution of internal totalizer 2.

### Entry:

- 1 = 0.001 (one thousandth)
- 2 = 0.01 (one hundredth)
- 3 = 0.1 (one tenth)
- 4 = 1 (unit)
- 5 = 10 (x ten)
- 6 = 100 (x hundred)
- 7 = 1000 (x thousand)

## P638 Totalizer 1 Resolution, External

This parameter sets the resolution of external totalizer 1.

### Entry:

- 1 = 0.001 (one thousandth)
- 2 = 0.01 (one hundredth)
- 3 = 0.1 (one tenth)
- 4 = 1 (unit)
- 5 = 10 (x ten)
- 6 = 100 (x hundred)
- 7 = 1000 (x thousand)

## P639 Totalizer 2 Resolution, External

This parameter sets the resolution of external totalizer 2.

### Entry:

- 1 = 0.001 (one thousandth)
- 2 = 0.01 (one hundredth)
- 3 = 0.1 (one tenth)
- 4 = 1 (unit)
- 5 = 10 (x ten)
- 6 = 100 (x hundred)
- 7 = 1000 (x thousand)

## P643 Totalizer 1 Contact Closure, External

The value of this parameter represents a multiple of 32 ms of contact closure for remote totalizer 1. The value is automatically calculated upon entry of P1 (design rate) and P638 (totalizer 1 resolution, external) so that the duration of contact closure allows the transistor switch response to track the total, up to 150% of the design rate. The minimum off time of the external totalizer is equivalent to the on time (50% duty cycle). (Example, 32 ms on time equals 64 ms cycle time.)

The value can be changed to suit specific contact closure requirements, such as in the case of programmable logic controllers. If a message E2 is displayed, P638 has to be increased.

### Entry:

- 1 = 32 ms
- 2 = 64
- 3 = 96
- 4 = 128
- 5 = 160
- 6 = 192
- 7 = 224
- 8 = 256
- 9 = 288

## P644 Totalizer 2 Contact Closure, External

The value of this parameter represents a multiple of 32 ms of contact closure for remote totalizer 2. The value is automatically calculated upon entry of P1 (design rate) and P639 (totalizer 2 resolution, external) so that the duration of contact closure allows the transistor switch response to track the total, up to 150% of the design rate. The minimum off time of the external totalizer is equivalent to the on time (50% duty cycle). (Example, 32 ms on time equals 64 ms cycle time.)

The value can be changed to suit specific contact closure requirements, such as in the case of programmable logic controllers. If a message E2 is displayed, P639 has to be increased.

### Entry:

- |           |         |
|-----------|---------|
| 1 = 32 ms | 6 = 192 |
| 2 = 64    | 7 = 224 |
| 3 = 96    | 8 = 256 |
| 4 = 128   | 9 = 288 |
| 5 = 160   |         |

## P647 Totalizer Display

Selects the totalizer combination to be displayed, either manually through the scroll display key or automatically by control of the display mode (P081).



**Entry:**

- 1 = totalizer 1
- 2 = totalizer 2
- 3 = totalizers 1 and 2

## P648 Totalizer Reset, Internal

Resets the internal totalizers.

**Entry:**

- 0 = idle
- 1 = reset totalizer 2
- 2 = reset totalizers 1 and 2

*End of Totalization parameters.*

## Communication (P751 - P761)

These parameters are specific to the use of the communication parameters. Refer also to *Communications*, page 47.

### P751 Baud Rate

Sets the baud rate for the proprietary bi-polar current loop. This baud rate is not applicable to communication via Milltronics Converter.

**Entry:**

- 300, 1200, 2400, 4800 or 9600 baud
- 4800 baud is required for Dolphin communications over the bi-polar current loop.

### P760 Communication Mode

Selects the communication mode.

- bi-polar current loop: interface with the host device (PLC or computer)
- infrared link: communication is made using the Milltronics ComVerter.
- maintenance: communication is made via the bi-polar current loop for **RUN** mode operations and infrared link for **PROGRAM** mode operations

**Entry:**

- 1 = bipolar current loop
- 2 = infrared link
- 3 = maintenance

### P761 Identification Number

Sets the identification number for the unit.  
Enter the desired identification number, range 0 - 15.  
*End of communication parameters.*

# Test and Diagnostic (P900 - P951)

**Note:** These parameters are used for test and diagnostic purposes.

## P900 Software Revision

Displays the EPROM (Flash ROM) software revision level.

## P901 Memory

Tests the memory. Test is initiated by scrolling to the parameter or repeated by **pressing ENTER**.

**Display:**

**PASS** = normal

**FAIL** = consult Siemens Miltronics.

## P907 Programmer Interface

Tests the infrared communications link. Test is initiated by scrolling to the parameter or repeated by **pressing ENTER**.

**Display:**

**PASS** = normal

**FAIL** = consult Siemens Miltronics.

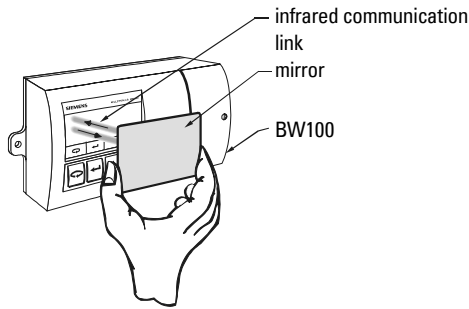

## P911 mA Output Value

Displays the value from the previous measurement. A test value can be entered and the displayed value is transmitted to the output. Upon returning to the **RUN** mode, the parameter assumes the actual mA output level.

## P940 Load Cell A, $mV_{in}$

Displays the mV signal input from the load cell. Range 0.00 - 60.00 mV.

## P941 Load Cell B, $mV_{in}$

Displays the mV signal input from the load cell. Range 0.00 - 60.00 mV.

## P942 V/F converter, $V_{in}$

Displays the input voltage to the voltage to frequency converter.  
Range 0 - 3.98 V

## P943 V/F converter, $f_{out}$

Displays the output frequency of the voltage to frequency converter.  
Range 0 - 131,072

## P944 Power sensor

Displays a voltage supply reference for diagnostic purposes.

## P949 Diagnostic Errors

Enables or disables diagnostic error checking, E101 - E104

### Entry:

0 = disable

1 = enable

Refer to *Troubleshooting* on page 65.

## P950 Zero register

Registers the number of zero calibrations that have been done since the last master reset.

## P951 Span Register

Registers the number of span calibrations that have been done since the last master reset.

## P952 Design Load

Displays the value of the design load, which corresponds to the full scale value for alarm and mA output functions. The design load is calculated, based on the design rate and design speed.

*End of test and diagnostic parameters.*

# P999 Master Reset

Resets parameters and totalizers to their factory setting.

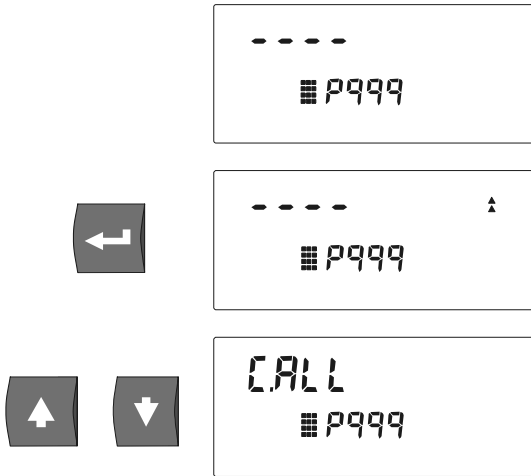

# Troubleshooting

message	diagnosis	action
E1 (program)	security code required	enter access code into P000
E2 (run)	totalizer resolution too low	increase value (P631 - P639)
E3 (run)	zero out of range	consider an initial zero P377, refer to <i>Recalibration/Initial Zero</i> on page 33
E4 (run)	span out of range	consider an initial span P388, refer to <i>Recalibration/Initial Span</i> on page 36
E5 (run)	parameter not entered	check parameters P005 - P017 for entry
E6 (run)	zero calibration required	do a zero calibration
E7 (run)	span calibration required	do a span calibration
E8 (program)	parameter value error	check that value is valid
E9(run)	auto zero out of range	auto zero has accumulated deviation beyond 2% from last operator initial zero. If error is not caused by material on belt, then do an operator initiated zero.
E10 (run)	rate or span out of range	loading on belt is 300% of rated load or greater. Investigate and if no mechanical cause, check to see if re-rating the design rate is required.
E11 (run)	speed greater than twice the design speed	check design belt speed against actual belt speed, check speed constant, perform speed constant adjust (P018) if necessary
E12 (factoring)	span out of range	test load is either too low or beyond 100% of design load (P952). Replace test weight with a heavier or lighter weight and try factoring again.

message	diagnosis	action
E101 (run)	load cell <b>A</b> mV reading is out of range	error will appear if: <ul style="list-style-type: none"> <li>• mV signal from load cell <b>A</b> or <b>B</b> is out of the 0-50 mV range</li> <li>• the mV signal from load cell <b>A</b> or <b>B</b> is less than the zero calibration mV level minus one half the span mV level</li> <li>• <b>A</b> or <b>B</b> mV is greater than 4 times the span mV value</li> </ul> check load cell mV signal and ensure that it is within range  check wiring
E102 (run)	load cell <b>B</b> mV reading is out of range	
E103 (run)	combined mV signal from load cell <b>A</b> and <b>B</b> is out of range	error will appear if the combined mV signal from load cell <b>A</b> and <b>B</b> is too low  check both load cell signals and ensure that they are greater than 0 mV  check wiring
E104 (run)	faulty memory location found	cycle power and perform memory test (P901)  if error reappears, the BW 100 must be repaired or replaced.
OF	no speed signal	check speed circuit or run conveyor

- Error messages are cleared when the condition is remedied.
- **RUN** mode errors are suppressed during **PROGRAM** mode, zero or span calibration.
- Zero and span errors are cleared when zero or span is initiated. Errors that happen during the calibration require re-starting the procedure.
- Program errors are cleared when any key is pressed.
- The messages E101 through E104 can be turned off (P949).
- The load cell errors are detected by certain conditions where it is apparent that the load cell is not functioning or incorrectly wired. It is not a conclusive test, since even with incorrect wiring, the resulting input from the load cell may be within a valid range.

# Maintenance

The BW100 requires no maintenance.

The external surface of the enclosure may be cleaned using a vacuum cleaner and a clean dry paint brush. The display window should be cleaned with a moist non-abrasive cloth.

It is a good idea to check the associated load sensing device, according to its instruction manual.

# Software Updates

The software can be updated from a floppy disk by use of a PC (IBM Compatible) with Milltronics Dolphin software. It is recommended that a reset (P999) is done after the software update followed by zero and span calibrations.

Direct zero entry (P367) and direct span entry (P368) will suffice in lieu of dynamic zero and span calibrations. Therefore, zero and span counts should be recorded prior to doing the software update.

# Appendix I

---

## Alphabetical Parameter List

Parameter	Number
Alarm Dead Band	P117
Baud Rate	P751
Belt Length	P016
Calculator Input 1	P291
Calculator Input 2	P292
Calculator Input 3	P293
Calculator Input 4	P294
Calibration Duration	P360
Calibration Security	P350
Communication Mode	P760
Compensation Point 1	P392
Compensation Point 2	P394
Compensation Point 3	P396
Damping	P080
Design Rate	P011
Design Speed	P014
Direct Span	P368
Direct Zero	P367
Display Mode	P081
Factoring	P359
High Alarm	P101
Identification Number	P761
Initial Zero	P377
Initial Span	P388
Linearization	P390
Linearizer Point 1	P391
Linearizer Point 2	P393
Linearizer Point 3	P395
Load Cell <b>A</b> , mV in	P940
Load Cell <b>B</b> , mV in	P941
Load Cell Balance	P295



<b>Parameter</b>	<b>Number</b>
Lock	P000
Low Alarm	P102
mA Function	P201
mA Output Damping	P220
ma Output Value	P911
mA Maximum Limit	P213
mA Minimum Limit	P212
mA Range	P200
mA Trim, 20	P215
mA Trim, 4	P214
Manual Span Adjust	P019
Master Reset	P999
Memory	P901
Minimum Speed Frequency	P022
Power Sensor	P944
Programmer Interface	P907
Relay Set Up	P100
Run Time	P341
Software Revision Number	P900
Span Register	P951
Speed Constant	P015
Speed Constant Adjust	P018
Test Load	P017
Totalizer 1 Closure, External	P643
Totalizer 2 Closure, External	P644
Totalizer 1 Resolution, External	P638
Totalizer 2 Resolution, External	P639
Totalizer 1 Resolution, Internal	P631
Totalizer 2 Resolution, Internal	P632
Totalizer Display	P647
Totalizer Drop out	P619
Totalizer Reset, Internal	P648
Units	P005
V/F Converter, V in	P942

Parameter	Number
V/F Converter, f out	P943
Zero Register	P950
Zero Limit	P370

## Program Record

Program Record	
Parameter	Value
P005 Units	
P011 Design Rate	
P014 Design Speed	
P015 Speed Constant	
P016 Belt Length	
P017 Test Load	
P018 Speed Constant Adjust	
P019 Manual Span Adjust	
P022 Minimum speed Frequency	
P080 Damping	
P081 Display Mode	
P100 Relay Set Up	
P101 High Alarm	
P102 Low Alarm	
P117 Alarm Dead Band	
P200 mA Range	
P201 mA Function	
P212 mA Min Limit	
P213 mA Max Limit	
P220 mA Output Damping	
P341 Run Time	
P350 Calibration Security	
P360 Calibration Duration	
P367 Direct Zero	
P368 Direct Span	
P370 Zero Limit	
P390 Linearization	
P391 Linearizer, Point 1	

<b>Program Record</b>	
<b>Parameter</b>	<b>Value</b>
P392 Compensation, Point 1	
P393 Linearizer, Point 2	
P394 Compensation, Point 2	
P395 Linearizer, Point 3	
P396 Compensation, Point 3	
P396 Compensation, Point 3	
P619 Totalizer Dropout	
P631 Total 1 Resolution, Int	
P632 Total 2 Resolution, Int	
P638 Total 1 Resolution, Ext	
P639 Total 2 Resolution, Ext	
P643 Total 1 Closure, Ext	
P644 Total 2 Closure, Ext	
P647 Totalizer Display	
P648 Totalizer Reset, Int	
P751 Baud Rate	
P760 Communication Mode	
P761 Identification Number	
P900 Software Rev.#	
P949 Diagnostic Errors	
P950 Zero Register	
P951 Span Register	
P952 Design Load	

# Appendix II: Software Revision History

Software Revision	Date	Changes
2.00	June 09, 1997	<ul style="list-style-type: none"> <li>Original software release</li> </ul>
2.01	July 04, 1997	<ul style="list-style-type: none"> <li>Decimal place location corrected</li> <li>Increased maximum number of digits for display</li> </ul>
2.02	April 09, 1999	<ul style="list-style-type: none"> <li>Totalizer decimal place corrected</li> </ul>
2.03	February 01, 2000	<ul style="list-style-type: none"> <li>mA output value (P911) corrected so that it does not lock when exiting without pressing Enter button</li> </ul>
2.04	May 04, 2001	<ul style="list-style-type: none"> <li>Totalizer error corrected when large total value is stored and power is cycled</li> <li>Allow totalizer reset when Security enabled</li> <li>Limited the mA trim values to less than 9999</li> </ul>
2.05	July 17, 2001	<ul style="list-style-type: none"> <li>Corrected mA trim values error introduced in revision 2.04</li> </ul>
2.06	July 16, 2002	<ul style="list-style-type: none"> <li>Software upgraded to support new microprocessor</li> </ul>
2.07	March 03, 2003	<ul style="list-style-type: none"> <li>Corrected remote totalizer error when totalizer dropout (P619) is set to 0.00</li> </ul>

# Index

## A

alarm  
    condition 44

## B

belt  
    speed compensation 29

belt scale 3

## C

controller  
    logic 45

## D

damping  
    value 52  
Dolphin 1, 3, 47

## E

EEPROM 4

## F

factoring 38  
function  
    alarm 43  
    output 43

## I

inearizer 58

## L

linearization 39  
    rate 1  
load cell 21

## M

mA  
    analog 1  
    input 54  
Master 64

## P

parameter  
    P000 security lock 50, 56  
    P005 design rate units 50  
    P011 design rate 43, 45, 50  
    P014 design speed 51  
    P015 speed constant 51  
    P016 belt length 51  
    P017 test rate 51, 56  
    P018 speed adjust 52  
    P019 manual span adjust 30, 52  
    P022 minimum speed frequency 52  
    P080 damping display 43, 52  
    P081 display scroll mode 60

P101 high alarm/deviation alarm 53  
P102 low alarm 53  
P117 alarm dead band 53  
P200 mA output range 43  
P200 mA range 54  
P201 mA function 54  
P212 mA output minimum 43, 54  
P213 mA output maximum 43, 54  
P214 mA output trim 43, 54  
P215 20 mA output trim 54  
P220 mA damping 43, 54  
P291 calculator input 1 55  
P292 calculator input 2 55  
P293 calculator input 3 55  
P295 load cell balancing 55  
P341 run time 55  
P350 calibration security 56  
P359 factoring 56  
P360 calibration duration 56  
P367 direct zero entry 34, 56  
P368 direct span entry 37, 56  
P370 zero limit deviation 56, 57  
P377 initial zero 57  
P388 initial span 57  
P390 linearizer 39, 57  
P391 linearizer, point 1 57  
P392 compensation, point 1 57  
P393 linearizer, point 2 58  
P394 compensation, point 2 58  
P395 linearizer, point 3 58  
P396 compensation, point 3 58  
P619 totalling dropout 45, 58  
P631 totalizer resolution 45, 59  
P632 totalizer 2 resolution, internal 59  
P638 external totalizer resolution 45,  
    59, 60  
P639 totalizer 2 resolution, external 59  
P643 external contact closure 45  
P643 totalizer 1 contact closure, exter-  
    nal 60  
P644 totalizer 2 contact closure, exter-  
    nal 60  
P647 totalizer display 46, 60  
P648 totalizer reset, internal 46  
P648 totalizer reset, internal 61  
P751 baud rate 61  
P760 communication mode 61

- P761 identification number 61
- P900 software revision 62
- P901 memory test 62
- P907 programmer interface 62
- P940 load cell 'A', mVin 62
- P941 load cell 'B', mVin 63
- P942 V/F converter, Vin 63
- P943 V/F converter, fout 63
- P944 power sensor 63
- P949 diagnostic errors 63
- P999 master reset 46
- relay set up 53

parameter

- P396 linearizer compensation % 39

## R

relay

- alarm 44

reset

- master 46

## S

span 37, 56

- adjust 30, 31
- calibration 27, 30, 39
- direct 37
- initial 33, 37, 57
- manual 30
- routine 35

## T

test

- load 30, 56
- material 30
- weight 27, 35
- weights 26, 32

totalizer 46

- functions 45
- master 45
- remote 1

## Z

zero

- auto 4
- calibration 26, 38
- direct 34
- initial 33, 34, 57



[www.siemens.com/processautomation](http://www.siemens.com/processautomation)

Siemens Milltronics Process Instruments Inc.  
1954 Technology Drive, P.O. Box 4225  
Peterborough, ON, Canada K9J 7B1  
Tel: (705) 745-2431 Fax: (705) 741-0466  
Email: [techpubs.smpi@siemens.com](mailto:techpubs.smpi@siemens.com)

© Siemens Milltronics Process Instruments Inc. 2007  
Subject to change without prior notice



7 M L 1 9 9 8 5 D J 0 2  
Printed in Canada

**Rev. 2.1**