

SIEMENS

SINUMERIK 840Di sI/840D sI/840D

HMI-Advanced

Operating Manual

Valid for

Control

SINUMERIK 840D sI / 840 DE sI
SINUMERIK 840Di sI / 840 DiE sI
SINUMERIK 840D powerline / 840DE powerline

Software
HMI-Advanced

Software version
7.5

Introduction	1
Operator Components/ Operating Sequences	2
Example of Operation	3
Machine	4
Parameters	5
Program	6
Services	7
Diagnostics operating area	8
Commissioning operating area	9
Maintenance	10
Appendix	A

SINUMERIK® Documentation

Printing history

Brief details of this edition and previous editions are listed below.

The status of each version is indicated by the code in the "Remarks" columns.

Status code in the "Remarks" column:

- A** New documentation.
- B** Unrevised reprint with new order number.
- C** Revised edition with new status.

Edition	Order No.	Remarks	SW assignment
02.01	6FC5298-6AF00-0BP0	C	
11.02	6FC5298-6AF00-0BP2	C	
03.04	6FC5298-6AF00-0BP2	C	NCU system software 7
08/2005	6FC5398-2AP10-0BA0	C	HMI-Advanced V 7.1
01/2006	6FC5398-2AP10-1BA0	C	HMI-Advanced V 7.2 SP1
11/2006	6FC5398-2AP10-2AA0	C	
01/2008	6FC5398-2AP10-3BA0	C	

Registered trademarks

All names with the protective right label ® are registered trademarks of the Siemens AG. The other product and system names in this document may be registered trademarks of their respective companies and must be treated accordingly. .

Disclaimer of liability

We have checked that the contents of this document correspond to the hardware and software described. Since deviations cannot be precluded entirely, we cannot guarantee full agreement. The information contained in this document is, however, reviewed regularly and any necessary changes will be included in the next edition.

Preface

SINUMERIK Documentation

The SINUMERIK documentation is organized in 3 parts:

- General documentation
- User documentation
- Manufacturer/Service Documentation

An overview of publications, which is updated on a monthly basis and provides information about the language versions available, can be found on the Internet at:

<http://www.siemens.com/motioncontrol>

Follow the menu items "Support" → "Technical Documentation" → "Overview of Publications".

The Internet version of DOConCD (DOConWEB) is available at:

<http://www.automation.siemens.com/doconweb>

Information about training courses and FAQs (Frequently Asked Questions) can be found in internet under:

<http://www.siemens.com/motioncontrol> under menu item "Support"

Target readership of this documentation

This manual is intended for machine-tool users. The document describes in detail all the technical information an operator needs to operate the SINUMERIK 840Di sl/840D sl/840D controls.

Standard scope

This Operator's Guide describes only the functionality of the standard version. Extensions or changes made by the machine manufacturer are documented by the machine manufacturer.

Other functions not described in this documentation might be executable in the control. This does not, however, represent an obligation to supply such functions with a new control or when servicing.

Questions on the manual

If you have any questions about the documentation (suggestions, corrections) please send

a fax or e-mail to the following address:

Fax: +49 (0) 9131 / 98 - 63315

E-mail: docu.motioncontrol@siemens.com

EC Declaration of Conformity

The EC Declaration of Conformity for the EMC Directive can be viewed/downloaded from the Internet at:

<http://support.automation.siemens.com>

under the Product Order No. 15257461 or at the relevant branch office of the A&D MC Division of Siemens AG.

Hotline

If you have any questions, please contact the following hotline:

Europe and Africa time zone:

A&D Technical Support

Tel.: +49 (0) 180 / 5050 - 222

Fax: +49 (0) 180 / 5050 - 223

Internet: <http://www.siemens.de/automation/support-request>

E-mail: adsupport@siemens.com

Asia and Australia time zone

A&D Technical Support

Tel.: +86 1064 719 990

Fax: +86 1064 747 474

Internet: <http://www.siemens.com/automation/support-request>

E-mail: adsupport@siemens.com

America time zone

A&D Technical Support

Tel.: +1 423 262 2522

Fax: +1 423 262 2289

Internet: <http://www.siemens.com/automation/support-request>

E-mail: adsupport@siemens.com

Internet address

<http://www.siemens.com/motioncontrol>

Safety information

This Manual contains information which you should carefully observe to ensure your own personal safety and the prevention of material damage. The notices referring to your personal safety are highlighted in the manual by a safety alert symbol, notices referring to property damage only, have no safety alert symbol. Depending on the hazard level, warnings are indicated in a descending order as follows:

**Danger**

Indicates that death or severe personal injury **will** result if proper precautions are not taken.

**Warning**

This warning notice indicates that death or severe personal injury **can** result if proper precautions are not taken.

**Caution**

means that there can be slight physical injury if the corresponding safety measures are not followed.

Caution

without a safety alert symbol, indicates that property damage may result if proper precautions are not taken.

Notice

This means that an undesirable result or an undesirable state can occur if the information is ignored.

Qualified persons

If multiple levels of hazards can occur, the warning is always displayed with the highest possible level. If a warning with a warning triangle is to indicate physical injury, the same warning may also contain information about damage to property.

The associated device/system may only be set-up and operated in conjunction with this documentation. The device/system must be commissioned and operated by **qualified personnel** only. Qualified personnel as referred to in the safety guidelines in this documentation are those who are authorized to start up, earth and label units, systems and circuits in accordance with the relevant safety standards.

Correct use

Please observe the following:

**Warning**

The device must only be used for the applications specified in the catalog and in the technical description. The device must only be used in conjunction with external devices and components recommended or approved by Siemens. Correct, reliable operation of the product required proper transport, storage, positioning and assembly, as well as careful operation and maintenance.

Export versions

Function	840DE sl 840DiE sl	840DE
Helical interpolation 2D+6 (Basic version, no options)	–	–
Milling machining package	–	–
Five axis machining package	–	–
Handling transformation package	–	–
Multi-axis interpolation (> 4 interpolating axes)	–	–
OA NCK compile cycles	–	–
Clearance control 1D/3D in position-control cycle ¹⁾	–	–
Synchronized actions ¹⁾ (Basic version, no options)	#	#
Master-value coupling and curve table interpolation	#	#
Sag compensation, multi-dimensional	#	#
Synchronized actions, stage 2 ¹⁾	–	#
Electronic gear ¹⁾	–	#
Electronic transfer	–	#

Restricted functionality

– Function not possible

1) In the case of the SINUMERIK 840DE sl/840DE/840DiE powerline export versions, the restricted functions are limited to "max. 4 interpolating axes"

Structure of descriptions

All functions and operating options have been described according to the same internal structure as far as this is meaningful and practicable. The various levels of information have been organized such that you can selectively access the information you need for the task in hand.

**1. Function**

The theoretical section is primarily intended as learning material for the NC entry-level user and includes important information to assist the user to understand the operator functions.

You should work through the manual at least once to get an idea of the operational scope and capability of your SINUMERIK control.

**2. Sequence of operations**

This section contains the sequence of keys required for operation at a glance. If inputs have to be made at individual stages of the sequence or if you require additional information, you will find this next to the key illustrations.

**3. Additional information**

For safety reasons, some functions are disabled to protect them from unauthorized access. The machine manufacturer can customize or modify the described functionality. Please comply fully with the instructions of the machine-tool manufacturer.



In this documentation, you will find this symbol with a reference to an ordering data option. The described function can only run if the control contains the designated option.









**Notes**

This symbol appears in this documentation whenever it is necessary to draw your attention to an important item of information.

**References**

This symbol appears whenever specific information can be found in other documentation.

A complete list of available literature is included in the Appendix of this Operator's Guide.

**Explanation of symbols:****Function****Sequence of operations****Additional information**
Cross-references to other documentation or sections
Danger notices
Additional notes or background information
Ordering data option
Explanation
Description of syntax
Programming Examples

Contents

Introduction	1-17
1.1 Product overview	1-18
1.2 Handling information	1-19
1.3 Switching on/switching off the control	1-20
Operator Components/Operating Sequences	2-23
2.1 Operator panel front	2-24
2.1.1 Keys on the operator panel front	2-24
2.1.2 Standard full keyboard	2-29
2.2 Machine control panel (MCP)	2-30
2.2.1 EMERGENCY STOP button	2-31
2.2.2 Operating modes and machine functions	2-31
2.2.3 Feedrate control	2-33
2.2.4 Spindle control	2-35
2.2.5 Key-operated switch	2-36
2.2.6 Program control	2-37
2.3 SINUMERIK HT 8	2-39
2.4 Screen layout	2-42
2.4.1 Displaying the control states	2-42
2.4.2 Global machine status display	2-43
2.4.3 Program control display	2-48
2.5 General operating sequences	2-50
2.5.1 Program overview and program selection	2-50
2.5.2 Changing the menu window	2-51
2.5.3 Selecting a directory/file	2-52
2.5.4 Editing inputs/values	2-53
2.5.5 Confirm/cancel input	2-54
2.5.6 Edit the part program in the ASCII editor	2-55
2.5.7 Switching over the channel	2-61
2.5.8 Packet calculator	2-62
2.6 Calling the help function	2-63
2.6.1 Editor help	2-65
2.6.2 Quick help for program commands	2-66
2.6.3 Extended help for program commands	2-69
2.7 Job list	2-70
2.7.1 Syntax description for job lists	2-72
2.7.2 Example of a job list with two-channel 1:1 links	2-75
2.7.3 Example of a job list with multi-channel m:n links	2-76
2.7.4 "Execute job list" operating sequence	2-77

2.7.5	Re-naming workpieces with job lists	2-79
2.7.6	Copying workpieces with job lists	2-80
2.7.7	Archiving workpieces with job lists in the case of M:N.....	2-80
Example of Operation		3-81
3.1	Typical operating sequence	3-81
Machine operating area		4-83
4.1	CNC data structure	4-85
4.1.1	Modes and machine functions	4-86
4.1.2	Modes group and channels.....	4-88
4.1.3	Cross-channel status display via symbols	4-89
4.1.4	Two-channel display	4-90
4.1.5	Mode selection, mode change	4-91
4.2	General functions and displays.....	4-94
4.2.1	Start/stop/abort/continue part program	4-94
4.2.2	Displaying the program level.....	4-95
4.2.3	Switching over the machine/workpiece coordinate system (MCS/WCS)	4-96
4.2.4	Displaying several transverse axes	4-98
4.2.5	Displaying axis feedrates	4-99
4.2.6	Display G functions, transformations and swivel data	4-100
4.2.7	Displaying auxiliary functions	4-101
4.2.8	Displaying modal M functions	4-101
4.2.9	Displaying spindles	4-103
4.2.10	Handwheel	4-104
4.2.11	Status of the synchronized actions	4-105
4.2.12	Preset	4-107
4.2.13	Setting the actual value	4-108
4.2.14	Inch ↔ Metric switchover	4-109
4.3	Reference point approach.....	4-111
4.4	JOG mode	4-114
4.4.1	Function and main screen.....	4-114
4.4.2	Traversing axes.....	4-117
4.4.3	Inc: Increment.....	4-118
4.4.4	REPOS (repositioning).....	4-119
4.4.5	SI (Safety Integrated): User agreement	4-120
4.4.6	Scratching	4-121
4.4.7	Displaying system frames	4-124
4.5	MDA mode	4-127
4.5.1	Function and main screen.....	4-127
4.5.2	Saving the program, file function.....	4-129
4.5.3	Teach in.....	4-130
4.6	Automatic mode	4-132
4.6.1	Function and main screen.....	4-132

4.6.2	Program overview	4-134
4.6.3	Loading and unloading the workpiece/part program	4-135
4.6.4	Protocol: Program loading list.....	4-136
4.6.5	Executing from the hard disk	4-137
4.6.6	Accessing an external network drive	4-138
4.6.7	Program editing.....	4-140
4.6.8	Setting the block search/search target	4-141
4.6.9	Accelerated external block search.....	4-145
4.6.10	Block search in Program test mode, multi-channel	4-148
4.6.11	Overstore	4-150
4.6.12	Program control	4-152
4.6.13	DRF offset.....	4-156

Parameters operating area..... 5-157

5.1	Tool data	5-159
5.1.1	Tool offset structure	5-159
5.1.2	Tool types and tool parameters	5-159
5.2	Tool offset	5-174
5.2.1	Function and main screen Tool offset.....	5-174
5.2.2	New tool	5-176
5.2.3	Display tool.....	5-177
5.2.4	Deleting a tool	5-178
5.2.5	New cutting edge	5-179
5.2.6	Deleting a cutting edge	5-180
5.2.7	Determining a tool offset.....	5-180
5.2.8	Make tool offset immediately effective.....	5-181
5.3	Tool management	5-182
5.3.1	Main tool management functions.....	5-183
5.3.2	Displaying/editing tool data	5-191
5.3.3	Change in the significance/representation of tool wear values	5-195
5.3.4	Grinding data expansion	5-198
5.3.5	Load	5-200
5.3.6	Unload.....	5-204
5.3.7	Relocating	5-206
5.3.8	Tool master data in the tool catalog.....	5-207
5.3.9	Tool offset data in the tool cabinet.....	5-210
5.3.10	Job processing of tools	5-213
5.4	R parameters (calculation parameters)	5-221
5.5	Setting data	5-222
5.5.1	Working area limitation	5-222
5.5.2	JOG data.....	5-223
5.5.3	Spindle data	5-224
5.5.4	Dry run feedrate for dry run operation DRY.....	5-225
5.5.5	Starting angle for thread cutting.....	5-226
5.5.6	Miscellaneous setting data	5-227

5.5.7	Protection zones	5-228
5.5.8	Electronic gear	5-229
5.6	Zero/work offset.....	5-230
5.6.1	Function.....	5-230
5.6.2	Edit the settable work offset (G54 ...)	5-232
5.6.3	Global zero offset/frame	5-232
5.6.4	Displaying an active settable work offset	5-235
5.6.5	Displaying an active programmable work offset	5-236
5.6.6	Displaying an active external work offset	5-237
5.6.7	Display the sum of the active work offsets	5-237
5.6.8	Activate active work offset and basic frame immediately	5-238
5.6.9	Actual value display: Settable zero system, SZS.....	5-238
5.7	Define user data	5-239
5.7.1	Define variables (GUD, PUD, LUD)	5-239
5.7.2	Editing/finding user data.....	5-240
5.7.3	Activate user data (GUD)	5-242
5.8	Display system variables.....	5-244
5.8.1	Creating variable views	5-245
5.8.2	Managing variable views	5-247
5.8.3	Logging system variables.....	5-248
"Program" operating area		6-251
6.1	Program types	6-253
6.1.1	Part program	6-253
6.1.2	Subprogram.....	6-253
6.1.3	Workpiece	6-253
6.1.4	Cycles.....	6-253
6.1.5	Storing programs.....	6-253
6.1.6	Templates.....	6-254
6.2	Main screen program	6-256
6.3	Edit programs in the standard ASCII Editor	6-258
6.3.1	Undo and redo in the standard ASCII editor	6-260
6.3.2	Additional optional editors	6-261
6.3.3	Selective program protection *RO*	6-261
6.4	Structured step sequence display (option).....	6-263
6.5	Multi-channel step sequence programming (option).....	6-267
6.5.1	Multi-channel workpiece program views	6-270
6.5.2	Activating timing	6-276
6.5.3	Activating simulation	6-277
6.6	Multiple editor (option).....	6-281
6.6.1	Operator/display functions in the ASCII full views	6-281
6.6.2	Alignment of the channels/MPFs to be displayed	6-285
6.7	Free contour programming.....	6-287

6.7.1	Programming a contour	6-288
6.7.2	Undercuts for turning technology	6-293
6.7.3	Parameterizing contour elements	6-296
6.7.4	Graphically displaying the contour	6-298
6.7.5	Symmetrical contours with milling technology	6-299
6.7.6	Specifying contour elements in polar coordinates, closing the contour	6-302
6.7.7	Support for contour programming	6-307
6.7.8	Parameter description of the contour elements straight line/circle	6-308
6.7.9	Programming examples for freely programming a contour	6-309
6.7.10	Cycle support	6-313
6.8	Program simulation	6-314
6.8.1	Using the simulation function	6-316
6.8.2	Simulation settings	6-325
6.8.3	Setting downtimes	6-331
6.8.4	Display and colors	6-332
6.8.5	Section-by-section simulation	6-333
6.8.6	Quick display in the simulation for mold making	6-334
6.8.7	Simulation with external network drive	6-336
6.8.8	Simulation for orientable toolholder	6-337
6.9	Managing programs	6-337
6.9.1	New workpiece/part program	6-339
6.9.2	Create programs/data in a workpiece directory	6-341
6.9.3	Saving setup data	6-342
6.9.4	Selecting a program to be executed	6-343
6.9.5	Loading/unloading a program	6-346
6.9.6	Manage programs	6-347
6.9.7	Copying/inserting	6-348
6.9.8	Deleting	6-351
6.9.9	Renaming	6-352
6.9.10	Enabling	6-353
6.9.11	Protocol	6-354
6.10	Accessing an external network drive/computer	6-355
	Services operating area	7-357
7.1	Services main screen	7-359
7.1.1	Reading-in data	7-362
7.1.2	Reading-out data	7-363
7.1.3	Displaying the log	7-364
7.2	Managing data	7-366
7.2.1	New file/new directory	7-367
7.2.2	Loading and unloading	7-367
7.2.3	Copying and inserting	7-368
7.2.4	Deleting	7-369
7.2.5	Changing properties	7-370
7.3	Data selection	7-373

7.3.1	Special directories and memory areas.....	7-376
7.3.2	Data on the hard disk.....	7-377
7.4	Transfer display MD from HMI Embedded.....	7-380
7.5	V.24 interface.....	7-382
7.5.1	Parameterizing the V.24 interface.....	7-382
7.5.2	Using the V.24 interface.....	7-386
Diagnostics operating area		8-391
8.1	Diagnostics main screen.....	8-392
8.2	Remote diagnostics.....	8-394
8.3	Alarms and messages.....	8-394
8.4	Service displays.....	8-396
8.4.1	Service axis.....	8-398
8.4.2	Service drive.....	8-399
8.4.3	Service SI (Safety Integrated).....	8-400
8.4.4	Systemressourcen anzeigen.....	8-412
8.4.5	Configuration data output.....	8-413
8.4.6	Communication error log.....	8-413
8.4.7	Action log.....	8-414
8.5	Calling the version screen.....	8-414
8.5.1	Sorting and saving version data.....	8-415
8.5.2	Display the version screens for cycles.....	8-416
8.5.3	Cycle version output.....	8-419
8.5.4	Displaying loadable compile cycles.....	8-419
8.6	Interrogating the PLC status.....	8-421
8.6.1	Changing/deleting a value.....	8-422
8.6.2	Assign symbolic PLC addresses.....	8-423
8.6.3	Select operand screens for PLC status.....	8-427
8.6.4	File functions.....	8-428
Commissioning operating area.....		9-429
9.1	Startup main screen.....	9-430
9.2	Machine data.....	9-432
9.3	NC.....	9-434
9.4	PLC.....	9-435
9.5	Optimization/test (SINUMERIK powerline).....	9-436
Maintenance.....		10-439
10.1	Operating data.....	10-440
10.2	Cleaning.....	10-441

Appendix A-443

- A Abbreviations A-444
- B Terms A-448

Index I-463

- I.1 Index I-463
- I.2 Commands and Identifier I-468

Introduction



1.1	Product overview	1-18
1.2	Handling information	1-19
1.3	Switching on/switching off the control	1-20

1.1 Product overview

The SINUMERIK controller is a CNC control system (**C**omputerized **N**umerical **C**ontrol) for machine tools.

You can use the CNC control system to implement the following basic functions in conjunction with a machine tool:

- Creation and adaptation of part programs
- Execution of part programs
- Manual control
- Reading in and reading out of part programs and data
- Editing of data for programs
- Displaying and troubleshooting alarms
- Editing of machine data
- Setting up of communication links between 1 or more operating units (m) or 1 or more NCs (n) (m:n, m operating units and n NCK/PLC units).

Operating areas

The basic functions are grouped in the following operating areas in the control (in gray boxes):

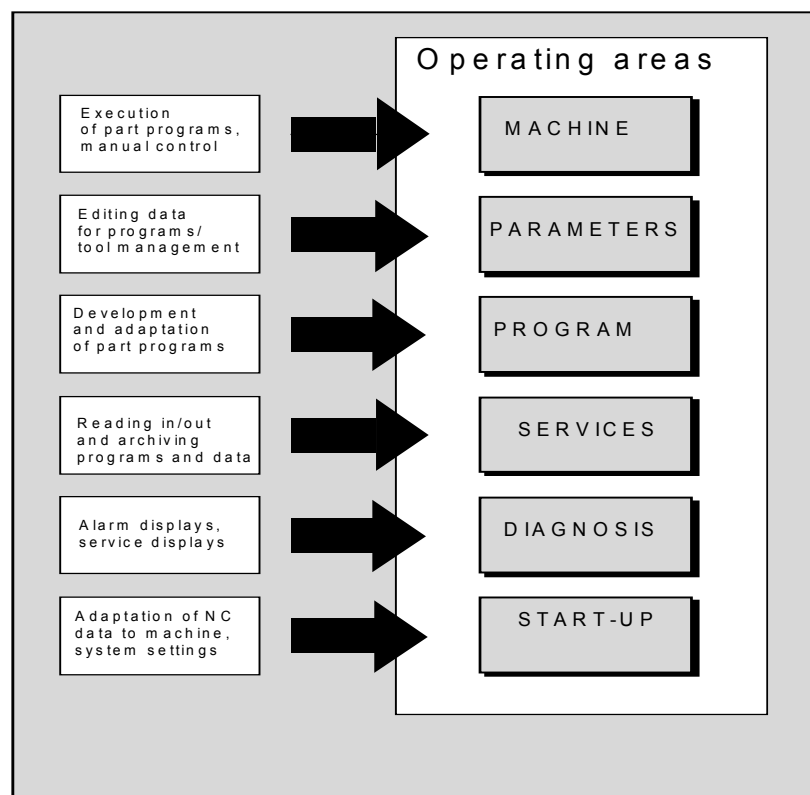



The user can call up all the functions via the user interface.

The user interface consists of:

- Display units such as screen, LEDs, etc.
- Control elements such as keys, switches, handwheels, etc.

Read Chapter 2 "Operation" carefully before proceeding with further chapters.

All subsequent chapters are written on the assumption that you have done so!

1.2 Handling information

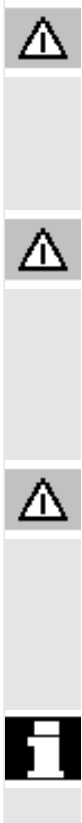

Caution

The operator panel front/machine control panel may only be opened by trained personnel for servicing purposes.

Danger

Never open the operator panel front/machine control panel unless the power supply has been disconnected! Failure to comply could result in fatal injury!

Warning

Electronic components inside the operator panel/machine control panel can be destroyed by electrostatic discharge if they are handled incorrectly.

Before operating any of the control elements on this operator panel front:

Please first read the explanations supplied in this documentation!

1.3 Switching on/switching off the control



Switching on



Function

A variety of methods can be employed to switch on the power supply to the control system or to the whole plant.

Machine manufacturer

Please follow the machine manufacturer's instructions!

After the control has been switched on, the "Reference point approach" display or another main screen programmed by the machine manufacturer will appear.

Machine		Jog			
Channel Reset					
Program aborted					
↵	MCS	Position		Master spindle	S1
	-X	0.000	mm	Act. +	0.000 rev./min
	+Y	0.000	mm	Set	0.000 rev./min
	+Z	0.000	mm	Pos.	0.000 deg.
	+	0.000	mm		0.000 %
				Power [%]	<input type="text"/>
				Feedrate	mm/min
				Act.	0.000 0.000 %
				Set	0.000
Tool					
▶ preselected tool : ◀					
▶ ◀					
G0 G91					
REF					

Switching off



Please follow the instructions below for switching off the control or the entire system!

Machine manufacturer

Please follow the machine manufacturer's instructions!



Sequence of operations

When you press the "Area switchover" key, operating areas are displayed on the horizontal softkey bar and operating modes are displayed on the vertical softkey bar. You can use this key to go to the area menu bar from any location in the menu hierarchy if you wish to select another operating mode or a different operating area.

Machine			Jog		
	Channel Reset		Program aborted	Exit	
	MCS	Position	Auxiliary Functions		MDI
	+ X	900.000 mm	M0	JOG	
	- Y	-156.000 mm	M0		
	+ Z	230.000 mm	M0		
			M0		
			H0.000000	RECALL	
			H0.000000		
			H0.000000		
			Feedrate mm/min		
			Act. 3000.000 0.0 %		
			Set. 3000.000		
			Tool		
			▶T0 D0◀		
			▶T0 D0◀		
			▶T0 D0◀		
			G1		
Machine	Parameters	Program	Services	Diagnosis	Start-up



By pressing the "Area switchover" key twice, you can toggle between the operating areas last selected, e.g. between the "Parameters" and "Machine" areas.

Notes

Operator Components/Operating Sequences

2.1	Operator panel front.....	2-24
2.1.1	Keys on the operator panel front.....	2-24
2.1.2	Standard full keyboard	2-29
2.2	Machine control panel (MCP)	2-30
2.2.1	EMERGENCY STOP button.....	2-31
2.2.2	Operating modes and machine functions	2-31
2.2.3	Feedrate control	2-33
2.2.4	Spindle control	2-35
2.2.5	Key-operated switch	2-36
2.2.6	Program control.....	2-37
2.3	SINUMERIK HT 8	2-39
2.4	Screen layout	2-42
2.4.1	Displaying the control states.....	2-42
2.4.2	Global machine status display	2-43
2.4.3	Program control display	2-48
2.5	General operating sequences.....	2-50
2.5.1	Program overview and program selection	2-50
2.5.2	Changing the menu window.....	2-51
2.5.3	Selecting a directory/file.....	2-52
2.5.4	Editing inputs/values	2-53
2.5.5	Confirm/cancel input	2-54
2.5.6	Edit the part program in the ASCII editor.....	2-55
2.5.7	Switching over the channel.....	2-61
2.5.8	Packet calculator.....	2-62
2.6	Calling the help function.....	2-63
2.6.1	Editor help	2-65
2.6.2	Quick help for program commands.....	2-66
2.6.3	Extended help for program commands.....	2-69
2.7	Job list	2-70
2.7.1	Syntax description for job lists	2-72
2.7.2	Example of a job list with two-channel 1:1 links.....	2-75
2.7.3	Example of a job list with multi-channel m:n links.....	2-76
2.7.4	“Execute job list” operating sequence.....	2-77
2.7.5	Re-naming workpieces with job lists	2-79
2.7.6	Copying workpieces with job lists	2-80
2.7.7	Archiving workpieces with job lists in the case of M:N.....	2-80

2.1 Operator panel front

Example

In this example, the OP 012 SINUMERIK operator panel front is used to illustrate the operator components, which are available for operating the SINUMERIK control and machine tool.

Properties

The OP 012 operator panel front with 12.1" TFT color display with a resolution of 800 x 600 pixels (SVGA) features a 59-key membrane keypad as well as 2 x (8 + 2) horizontal and 2 x 8 vertical softkeys and a built-in mouse.

- A Display
 - B Alphanumeric keypad
Correction/cursor keys
 - C Mouse and mouse keys
- 1 Machine area key
 - 2 Recall (return)
 - 3 Softkey bar (horizontal)
 - 4 ETC key
(menu extension)
 - 5 Area switchover key
 - 6 Softkey bar (vertical)



2.1.1 Keys on the operator panel front



Keys on the operator panel front

The elements of the operator panel keyboard and the symbols used to represent them in this manual are shown and explained below. The keys marked with an * correspond to the key symbols in US layout.



Softkeys

Keys to which functions are assigned by means of a menu bar displayed on the screen.

- It is possible to access further menu levels via the horizontal softkeys in any operating area. Each horizontal menu item has a vertical menu bar/softkey assignment.
- The vertical softkeys are assigned functions for the currently selected horizontal softkey.

A function is called up by pressing one of the vertical softkeys. The assignments of the vertical softkey bar can change if further subsidiary functions are classified under a function.

Parameter



Softkey (horizontal or vertical):

This key symbol indicates that you must have selected an operating area or a menu item or have already performed certain functions before you are able to execute the function described in the relevant section.

Machine area key

Direct branch to the "Machine" operating area.

Recall key

Return to the higher-level menu. Recall closes a window.

ETC key

Expansion of the horizontal softkey bar in the same menu.

Area switchover key

You can call the main menu from any operating area by pressing this key. Pressing the key twice in succession changes from the current operating area to the previous one and back again.

The standard main menu branches into the following operating areas:

1. Machine
2. Parameters
3. Program
4. Services
5. Diagnostics
6. Commissioning

Shift key

Switches between functions on keys with double assignment.

Switch over channel

In a configuration with several channels, it is possible to switch between channels (switch from channel 1 through to channel n). When a "Channel menu" is configured, all existing communication links to other NCUs plus the associated channels are displayed on softkeys.

(See Section "Switch over channel")



Acknowledge alarm key

By pressing this key, you can acknowledge the alarm marked by this Cancel symbol.



Information key

This key displays explanatory information about the current operating status (e.g. support for programming, diagnostics, PLC, alarms). The letter "i" displayed in the user response line indicates that information is available.



Window selection key

If several windows are displayed on the screen, it is possible to make the next window the active one using the window selection key (the active window has a thicker border).

Keyboard input e.g. the page keys, is possible only in the active window.



Cursor up



Cursor down



Cursor to the left



Cursor to the right



PAGE DOWN

You "scroll" down by one display.

In a part program, you can "scroll" the display down (to end of program) or **up** (to start of program).



PAGE UP

You "scroll" up by one display.

With the page keys you scroll the visible/displayed area of the window that is active. The scroll bar indicates which part of the program/document/... is selected.



Backspace

Delete characters from right

Space character (Blank)



Selection key

- Selection key for values set in input fields and selection lists labeled with this key symbol.
- Activate/deactivate a field:

= active

= active

= not active

= not active

Multiple option button

(you can select several options or none)

Single-option button/option

(only one option can be active at a time)



Edit key / undo key

- Switch over to edit mode in tables and input fields (in this case, the input field is in insert mode) or
- UNDO function on table elements and input fields (the value is not validated when you exit a field using the edit key; instead it is reset to the previous value = UNDO).



End of line key

- With this key, the cursor is moved to the end of the line in the page opened in the editor.
- Rapid positioning of the cursor on a group of related input fields.
- Has same effect as Tab key.



Delete key

The setting in a parameterization field is deleted.

The field remains blank.



Input key

- Accepts an edited value
- Opens/closes a directory
- Opening a file



Tab key



Ctrl key



Alt key



Tool offset

Takes you directly to the tool offset

*



*



*

**Program management** program overview

A program can be opened in the text editor.

Interrupt
screen

Takes you directly to the Alarms

User key

Can be configured by the customer

Notes

The keys marked with an * also have a function in conjunction with ShopMill/ShopTurn.

“PROGRAM” hardkey

For this function to work, at least one recently edited program must be found with sufficient read rights. The program must not be already open in either a simulation or any other application. Actions such as load, copy, select, etc. must not be in progress and the part program must not be running on the NC.

In the above cases, the operation is denied with alarms 1203xx.



Press this hardkey in any operating area to reopen and display the part program or file last edited in the Program operating area:

- If you are already in the Program operating area and the editor is open, the program you last edited is displayed.
- If you are in any other operating area, and the editor is open, you jump back to the editor in the Program operating area and the most recent editor status is displayed.

If the editor is **not open**:

- If you are in another user application, you jump back to the Program operating area and the editor is opened with the program you last edited.

2.1.2 Standard full keyboard



A full standard keyboard can be connected. However, a machine control panel is required in addition to this keyboard.

The special function keys of the operator keyboard can also be used with the full PC keyboard. The following table shows how the horizontal and vertical softkeys and the special keys for the operator panels are mapped onto the PC keyboard keys:

Softkey assignment

Full keyboard	F1	F2	F3	F4	F5	F6	F7	F8	F9	F10	F11	F12
with SHIFT	vertic soft. 1	vertic soft. 2	vertic soft. 3	vertic soft. 4	vertic soft. 5	vertic soft. 6	vertic soft. 7	vertic soft. 8	>	MACHINE		
without SHIFT	horiz soft. 1	horiz soft. 2	horiz soft. 3	horiz soft. 4	horiz soft. 5	horiz soft. 6	horiz soft. 7	horiz soft. 8	△	MENU SELECT	CHANNEL	HELP
Full keyboard	5	Esc	Insert	Home	Page Up	Page Down	Enter	End				
without SHIFT	SELECT	ALARM CANCEL	INSERT	NEXT WINDOW	PAGE UP	PAGE DOWN	INPUT	END				

The following table shows how the hardkeys of the MF 2 keyboard on the PC are mapped onto the keys for the operator panels:

Hardkey assignment

Hardkey	Hard key 1	Hard key 2	Hard key 3	Hard key 4	Hard key 5	Hard key 6	Hard key 7	Hard key 8				
MFII with SHIFT	F11					F12	F10					
MFII without SHIFT								F10				
MFII-Num Block		END	Page Down	Home	Page Up							
operator keyboard	M-Position	PROGRAM	OFFSET	PROGRAM MANAGER	ALARM	CUSTOM	MACHINE	RECALL SELECT				



Caution

The full standard keyboard does not meet the requirements (EMC) of a SINUMERIK control. For this reason, it can be used only for installation and service purposes.

Additional information

Since the English version of Windows is used in the control, the keyboard language is English. A different keyboard language cannot be set.

2.2 Machine control panel (MCP)



Actions on the machine tool, for example traversing the axes or program start, can only be initiated via a machine control panel.

The machine tool can either be equipped with a standard machine control panel from SIEMENS (ordering data option) or with a specific machine control panel from the machine-tool manufacturer.

The following description applies to the 19" machine control panel supplied by SIEMENS (= standard). If you are using another machine control panel, please consult the operating instructions of the machine-tool manufacturer.

The standard machine control panel is equipped with the following control elements:

- 1 EMERGENCY STOP button
- 2 Operating modes (with machine functions)
- 3 Incremental mode
- 4 Program control instructions
- 5 Direction key with rapid traverse override
- 6 Spindle control
- 7 Feedrate control
- 8 Key-operated switch

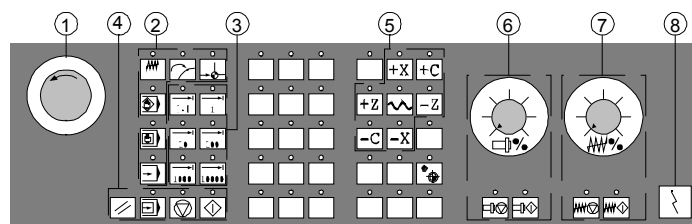

Machine control panel for turning machines

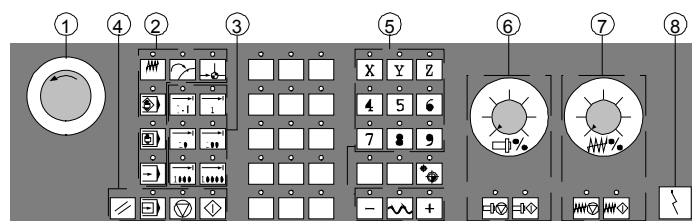

Machine control panel for milling machines

2.2.1 EMERGENCY STOP button

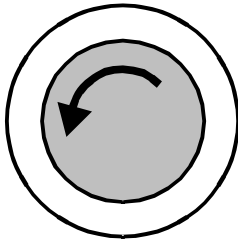

Machine manufacturer

EMERGENCY STOP button

Press this red key in emergency situations:

1. if life is at risk
2. When there is a danger of the machine or workpiece being damaged.

As a rule, when operating the EMERGENCY STOP button, all drives are brought to a standstill with max. braking torque.

For details of other or additional responses to an EMERGENCY STOP:

Please read the information supplied by the machine tool manufacturer!

2.2.2 Operating modes and machine functions



Modes of operation

The active mode is signaled and confirmed by the associated LED, which lights up.

The keys marked with an * correspond to the key symbols in US layout.

If you press a "Mode key", the corresponding mode is selected if permissible, and all other modes and functions are deselected.



JOG

(Jogging)

Axis travel in jog mode via:

- Continuous motion of the axes using the direction keys, or
- Incremental motion of the axes using the direction keys, or
- Handwheel



MDA

(Manual Data Automatic)

Control of machine through execution of a block or a sequence of blocks. The blocks are entered on the operator panel front.



Automatic

Control of machine through automatic execution of programs.

Inc keys

You can activate the Inc functions in conjunction with the following modes:

- "JOG" mode
- "MDA/Teach-in" operating mode

**Inc VAR (Incremental feed VARIABLE)**

Incremental mode with variable increment size
(see operating area Parameters, Setting data).

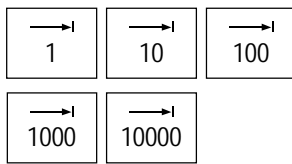
**Inc (Incremental feed)**

Incremental mode with fixed increment size of 1, 10, 100, 1,000, 10,000 increments.

A machine data code defines how the incremental dimension is interpreted.

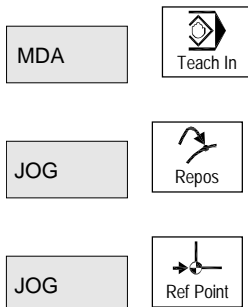
**Machine functions****Teach In**

Creation of programs in interactive mode with the machine in "MDA" mode.

Repos

Repositioning

Reposition, re-approach contour in "JOG" mode.

Ref

Approaching a reference point

Approach the reference point (Ref) in "JOG" mode.

2.2.3 Feedrate control

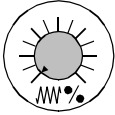

Feedrate rapid traverse override (feedrate override switch)

Control range:

0% to 120% of programmed feedrate.

In rapid traverse, the 100% value is not exceeded.

Settings,

0%, 1%, 2%, 4%, 6%, 8%, 10%, 20%, 30%, 40%, 50%, 60%, 70%, 75%, 80%, 85%, 90%, 95%, 100%, 105%, 110%, 115%, 120%

Feed stop

If you press the "Feed stop" key:

- Execution of the current program is stopped
- The axis drives are brought to a standstill under control, The associated LED lights up as soon as feed stop has been accepted by the control and

The following appears in the header (program control display):

FST (= Feed Stop)

Example:

- In "MDA" mode, an error is detected during execution of a block.
- ~ A tool change is to be carried out.

Feed start

If you press the "Feed start" key:

- The part program is continued in the current block,
- The feedrate is accelerated to the value specified by the program,
- The associated LED lights up as soon as feed start has been accepted by the control.

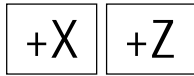
**Axis keys (for turning machines):**

Press these keys to traverse the selected axis (X ... Z) in the positive direction.

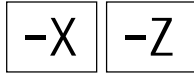

Press these keys to traverse the selected axis (X ... Z) in the negative direction.

**Axis keys (for milling machines):**

Select the axis (X ... 9) for traversing



in the positive direction by pressing the "+" key or



in the negative direction by pressing the "-" key.

**Rapid traverse override**

If you press this key together with key "+" or "-", the axis moves in rapid traverse mode.

**Machine manufacturer**

- The specified increments and control range apply to standard machines.
- Increments and control range can be modified by the machine tool manufacturer to suit specific applications.
- Feedrate/rapid traverse feedrate and the values for the feedrate override positions (if the feedrate override switch is also active for rapid traverse) are defined in the machine data (see the information supplied by the machine manufacturer).

**MCS/WCS**

You can switch between the machine and workpiece coordinate systems in the Machine operating area using softkeys (MCS)/(WCS) or the corresponding key on the machine control panel.

2.2.4 Spindle control

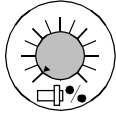

Spindle override (spindle speed override switch)

The rotary switch with latch positions allows you to increase or decrease the programmed spindle speed "S" (equivalent to 100%). The set spindle speed value "S" is output as an absolute value and a percentage in the "Spindles" display (vertical softkey on main screen).

Control range:

50% to 120% of programmed spindle speed

Increment:

5% between latch positions



Spindle stop

When you press the "Spindle stop" key:

The spindle is decelerated down to zero speed and

The associated LED lights up as soon as "Spindle stop" is reached.

Example:

To change a tool

To enter S, T, H, M functions during setup



Spindle start

When you press the "Spindle start" key:

The spindle speed is accelerated to the value defined in the program and

The associated LED lights up as soon as "Spindle start" has been accepted by the control.



Machine manufacturer

- The specified increment and the control range apply to standard machine data (MD). These MD can be edited by the machine-tool manufacturer to suit the specific application.
- The maximum spindle speed and the values for the spindle speed override position are defined in the machine data and setting data (see information supplied by the machine-tool manufacturer).

2.2.5 Key-operated switch



Machine manufacturer

Functions can be assigned to key-operated switch positions by the machine manufacturer. Using machine data, it is also possible to set access to programs, data and functions to suit the user's requirements.

SIEMENS key-operated switch

The key-operated switch on the SINUMERIK 840D has 4 settings, assigned to protection levels 4 to 7.

The key-operated switch has three different colored keys which can be removed in the specified positions:

Switch positions



Position 0
No key
Protection level 7



Position 1
Key 1 **black**
Protection level 6



Position 2
Key 1 **green**
Protection level 5



Position 3
Key 1 **red**
Protection level 4

Lowest
Access authorization

Highest
Access authorization



Changing access rights

The screen is not automatically updated after a change in access authorization (e.g., when the key-operated switch position is changed), but only when the screen is next refreshed (e.g., on closing and opening a directory).

The currently valid access authorization is checked every time a function is executed.

If the PLC is in the STOP state, the input image of the machine control panel is not scanned. For this reason, the key-operated switch positions are not evaluated during commissioning.

Passwords



References

As an additional option for setting access authorization, it is possible to enter three passwords in the "Commissioning" operating area. If the password is set, the key-operated switch positions are irrelevant. /IAD/, Commissioning Manual 840D.

2.2.6 Program control



Cycle Start



Cycle Stop



Single Block

NC Start

If you press the "NC Start" key, the selected part program (part program name is displayed in header) is started at the current block and the associated LED lights up.

NC stop

If you press the "NC Stop" key, processing of the active part program is halted and the associated LED lights up.

After this, you can continue processing with NC Start.

Single block

This function allows you to execute a part program block by block. You can activate the "Single Block" function in "Automatic" and "MDA" modes. If single block is activated, the associated LED on the machine control panel lights up.

- If single block execution is active, Stop is displayed on the screen in the cycle (in the program control line)
- The message "Stop: Block completed in single block" is displayed in the channel operational message line (in interrupt state).
- The current block in the part program will not be executed until you press the "NC Start" key.
- Program processing is stopped after one block is executed.

You can execute the next block by pressing the "NC Start" key again.

You can deselect the function by pressing the "Single block" key again.



This function is dependent on the settings under "Program control" in the Machine operating area.

Reset

When you press the <Reset> key:

- Execution of the current part program is aborted.
- Messages issued by the monitoring function are deleted (except the alarms POWER ON, NC Start and "Acknowledge alarm").
- The channel is set to "Reset" state, i.e.,
 - \sim The NC control remains synchronized with the machine.
 - \sim The control is in its initial state and ready for a new program run.



References

/FB/ K1, Description of Functions BAG, Channel, Program control.

2.3 SINUMERIK HT 8



The mobile SINUMERIK HT 8 handheld terminal combines the functions of an operating panel and a machine control panel. It is therefore ideal for visualization, operation, teach-in, and programming at the machine:

- Manipulators/robots
- Machine tools
- Production machines

The 7.5 TFT color display provides touch operation. It also has membrane key for traversing the axes, for numeric input, for cursor control, and for machine control panel functions like start and stop.

Prerequisite

To operate the HT 8, you must have the operator privilege.



Keyboard operation

See section "Machine control panel" for a description of the individual keys.



Machine manufacturer

The four customer keys are freely assignable and can be set up customer-specifically by the machine manufacturer.

This <STANDBY> key presently has no function.

Key <U>

The CPF softkey bar is displayed with the <U> key:

**CPF softkeys
(Control Panel Function)**

The CPF softkeys keys of the machine control panel emulated by the HMI software. When the HT 8 has operator rights, the CPF menu is displayed with the <U> key. The menu is automatically hidden when the area is changed.

The following softkeys are available (see figure on the left):

- <MACHINE> softkey: Select the "Machine" operating area (corresponds to <Shift> + <F10>).
- < [VAR] > softkey: Select the axis feedrate in the increment.
- <Single Block> softkey: Switch single block execution on/off.
- <WCS MCS> softkey: Switching between MCS ↔ WCS
- "Back" softkey: Hide CPF menu; restoration of the user response line and the softkeys.

The CPF menu is not displayed when the area menu or the channel menu is active.

With the <MACHINE> softkey, the "multi-channel display" function is also operator-controllable on the HT 8. The respective state is displayed in the global machine status display (header).

(Mail Detlev Lutter from 15.06.2007)

The PLC interface signals, that are initiated using the softkeys of the CPF menus, are edge-controlled.

Traversing keys

JOG and MDA / Teach In mode must be selected to set up the axes with the traversing keys.

The labeling of the 12 traversing keys is shown on the housing of the touch panel. Display of the labeling for up to 6 axes is performed by the PLC program (machine manufacturer).

If the labeling for the traversing keys is displayed, all the other softkeys cannot be operated.

Switch over channel

Channel switchover is performed by touch operation of the touch surface on the global machine status display:

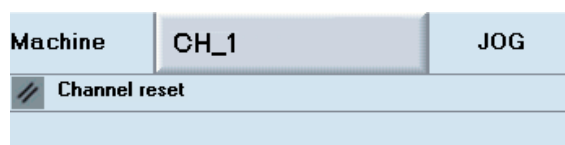

Virtual keyboard

The virtual keyboard is displayed from the active operator area. The keyboard is automatically hidden again when changing the area or when exiting the application. The virtual keyboard is located across the complete header and can be shifted using the mouse.

The following languages can be selected for the virtual keyboard online: German, English, French, Spanish.

Language changeover



The virtual keyboard can be displayed and hidden in all operator areas using a touch field located above the vertical softkeys. This touch field is **only** displayed if the connected HT 8 or Touch Panel has operator rights.

Calibrating touch panel

To perform calibration, press the keys <Recall> + <MENU SELECT> simultaneously to start the command shell:

1. The "Calibrate TouchPanel" button starts calibration.
2. Follow the instructions on the screen and touch the three calibration points one after the other.

This completes the calibration.

3. Then press the horizontal softkey or button "1" to make the connection to the required PCU and return to the HMI-Advanced user interface.

References

"Operator Components and Networking" Manual



2.4 Screen layout

2.4.1 Displaying the control states

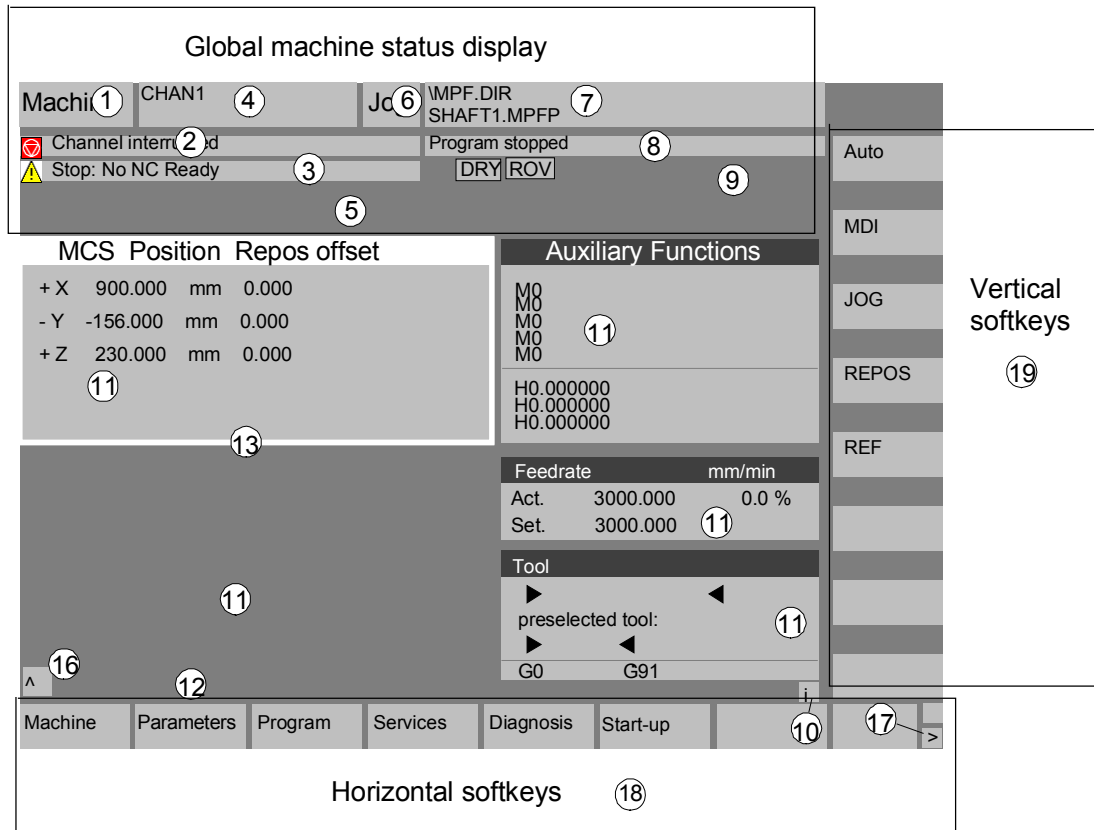

- 1 Operating areas
- 2 Channel status
- 3 Channel operational messages
- 4 Channel name
- 5 Alarm and message line
- 6 Operating mode, submode, (increment if relevant)
- 7 Program name of the selected program
- 8 Program status
- 9 Program control
- 10 Additional information (help)
 - i You can display information by pressing the i key
 - ^ Recall: Return to higher-level menu
 - > ETC.: Expansion of the horizontal softkey bar in the same. Menu

11 Working windows, NC displays

The working windows (program editor) and NC displays (feedrate, tool) available in the selected operating area are displayed here.

The unit for positional data is preceded by the diameter symbol \varnothing in the work pane if the axis is currently the transverse axis and if the tool coordinate system is set. If diameter programming is disabled with DIAMOF, the symbol preceding the unit is no longer visible.

12 User response line with user information

Here user information is displayed for the selected function (if available).

13 Focus

The selected pane is highlighted by a frame. The window header display is inverted. Data entered on the operator panel front apply to this window.

16 Recall function, i.e., key ^ is active**17 ETC. function, i.e., > key is active****18 Horizontal softkeys****19 Vertical softkeys**

The softkey functions available in the selected operating area are displayed in the horizontal/vertical softkey bar (corresponding to F1 to F8 on the full keyboard).

Additional information

The screen layout may differ slightly from the layout displayed above, depending on the screen size or resolution used.

2.4.2 Global machine status display**1 Operating areas**

The currently selected operating area is displayed (Machine, Parameters, Program, Services, Diagnostics, Commissioning).

2 Channel status

The current channel status is displayed

- Channel reset
- Channel interrupted
- Channel active

3 Channel operational messages

For displaying the channel operational messages with symbols:

If the status shows this symbol , operating input is required.



- | | |
|---|--|
| 1 Stop: | No NC Ready |
| 2 Stop: | Mode Group Ready |
| 3 Stop: | EMERGENCY STOP active |
| 4 Stop: | Alarm active with stop |
| 5 Stop: | M0/M1 active |
| 6 Stop: | Block ended in SBL mode |
|  7 Stop: | Cycle stop active |
| 8 Wait: | No read-in enable |
| 9 Wait: | No feed enable |
| 12 Wait: | No axis enable |
| 17 Wait: | Feedrate override > 0% |
| 18 Stop: | Error in NC block |
| 19 Wait: | For external NC blocks |
| 22 Wait: | No spindle enable |
| 23 Wait: | Axis feedrate value is 0 |
| 31 Stop: | No channel ready |
| 45 Stop: | SERUPRO search has found search target and the NCK has stopped. SERUPRO is the abbreviation for "SEarchRUn by PROgram test"; it is a new type of block search. |

If the status shows this symbol , operation is generally not required.



- | | |
|----------|---|
| 10 Wait: | Remaining dwell time __ Sec. for seconds or
Remaining dwell time __ rev. for revolutions

This can be parameterized via an OPI variable. 0 = sec./1 = rev. |
| 11 Wait: | No aux. funct. ackn. |
| 13 Wait: | Exact stop not reached |
| 14 Wait: | For positioning axis |
| 15 Wait: | For spindle |
| 16 Wait: | For other channel |
| 20 Wait: | Due to SYNACT instruction |
| 21 Wait: | Block search active |

24 Wait:	For tool change acknowledgement
25 Wait:	For gear stage change
26 Wait:	For position control
27 Wait:	For thread cut
 29 Wait:	For punching
30 Wait:	For safe operation
32 Stop:	Oscillation active
33 Stop:	Axis replacement active (block change inhibited because axis replacement in progress)
34 Wait:	For axis container rotation
35 Wait:	AXCT axis active as slave axis
36 Wait:	AXCT axis active as master axis
37 Wait:	AXCT axis changing to follow-up
38 Wait:	AXCT internal status change in axis
	This delay status may be attributable to the following causes:
	<ul style="list-style-type: none"> • Activation of position control • Requesting of zero marker • Reference point approach active • Parameter block change active • Measuring system change active • Measurement on-the-fly active • Closed-loop controller enable removed • Status change, axis/spindle disable
39 Wait:	AXCT axis drive disable
40 Wait:	AXCT axis overlaid motion active
41 Wait:	AXCT axis axis replacement active
42 Wait:	AXCT axis interpolator active
43 Wait:	WAIT_FOR_CC_ENABLE: Waiting for compile cycle
44 Wait:	On access to system variable
46 Stop:	ESR triggered
47 Wait:	Axis container rotation waiting for spindle stop
48 Wait:	Axis container rotation waiting for synchronization of MD data (New-Config)

49 Wait:	For axis replacement: Axis currently coupled
50 Wait:	For axis replacement: Lift fast active
51 Wait:	For axis replacement: New-Config active
52 Wait:	For axis replacement: Axis container rotation active
53 Wait:	For axis replacement: Waitp active
54 Wait:	For axis replacement: Axis is currently in another channel
55 Wait:	For axis replacement: Axis is currently a PLC axis
56 Wait:	For axis replacement: Axis is currently an oscillating axis
57 Wait:	For axis replacement: Axis is currently a JOG axis
58 Wait:	For axis replacement: Axis is currently a command axis
59 Wait:	For axis replacement: Axis is currently an OEM axis



60 Wait:	For axis replacement: Axis is currently a slave axis coupled to the master value
61 Wait:	For axis replacement: Axis is currently a coupled-motion slave axis
62 Wait:	For axis replacement: Axis is currently a coupled slave axis

4 Channel name	Name of the channel in which the program is running.
5 Alarm and message line	<ul style="list-style-type: none"> - Alarms and messages or - Instructions that were programmed in the part program using the MSG command (if no alarms are active)
6 Operating mode display	<p>The currently selected operating mode, i.e. JOG, MDA or AUTO (automatic) is displayed.</p> <p>The active submode is displayed next to the operating mode. An active increment is also displayed underneath, e.g.,</p> <p style="margin-left: 40px;">JOG Repos 1000</p>
7 Program name	<p>Press NC Start to execute this program.</p> <p>The "Program name" output field can be configured for JOG and MDA (see machine manufacturer's specifications).</p>

8 Program status

The current status of the part program being executed is output:

- Program aborted
- Program running
- Program stopped

The "program status" output field can be configured, e.g. with the "Channel-wide status display with symbols" function (Subsection 4.1.3 and see machine manufacturer's specifications).

9 Program control display

Functions that have been activated can be set via "Program control" so that they are displayed.

(See Section 4.6 Automatic mode, "Program control")

2.4.3 Program control display



SKP

Skip block

Function

Functions that have been activated are visible in the program control display (can be set via "Program control", see Subsection 4.6.12). The functions are displayed irrespective of the selected menu.

Program blocks in which the block number is preceded by a slash are skipped when you run the program (e.g. "/N100 ..."). Up to 10 program levels can be hidden (e.g., "/6N100 .."; the 7th program level is hidden)

References: /PG/ Programming Manual Fundamentals, Chapter 2.

SKPn

n = active skip levels

SBL1

Single block with STOP after each machine function block

If this function is active, execution is interrupted after every block that triggers a function on the machine (calculation blocks do not cause an interruption).

SBL2

Single block with stop after each block

If this function is active, the part program blocks are executed as follows: Each block is decoded separately and execution is interrupted after every block.

SBL3

Stop in cycle

If this function is active, the part program blocks are executed individually in the cycle as follows:
Each block is decoded separately and execution is interrupted after every block. Part program blocks are

- Traversing blocks
- Switching and auxiliary functions
- Blocks generated internally in the controller (e.g. blocks inserted for tool radius compensation)
- Thread blocks after retraction
- Thread blocks with dry run feedrate

Thread blocks without dry run feedrate are an exception to this. In such blocks, a stop is only performed at the end of the current thread block. SBL2 can only be selected in the Reset state.

Either SBL1 or SBL2 can be selected!

This function can be activated only in the "Single block" state.

DRY DRY run feedrate	<p>Traverse movements are performed with the feedrate value set in the setting data "Dry run feedrate".</p> <p>This dry run feedrate function replaces the programmed motion commands.</p>
ROV Rapid traverse override	<p>The override switch for the feedrate also applies to the rapid traverse feedrate.</p>
M01 Programmed stop 1	<p>When this function is active, processing of the program is stopped at every block in which miscellaneous function M01 is programmed. The message "Stop: M00/M01 active" is then displayed on the screen. Press the NC Start key to resume execution. If the function is not activated, special function M01 (from the part program) is not taken into account.</p>
Additional M fct. Programmed stop 2	<p>When this function is active, program execution on the NC is interrupted on request by the PLC at blocks containing the additional function for a conditional stop.</p> <p>The machine data 22256: AUXFO_ASSOC_M1_VALUE you can define a function associated with M01. The value of this miscellaneous M function number is then equivalent to a programmed stop 2.</p>
 References	<p>/FB1/Description of Functions - Basic Machine</p> <p>Predefined Auxiliary Function "Associated auxiliary functions for M0, M1"</p>
DRF DRF selection	<p>When the "DRF" function is active, DRF offsets are applied.</p>
PRT Program test	<p>If "Program test" is selected, the output of setpoints to axes and spindles is disabled. The setpoint display "simulates" the traverse movements.</p>
FST Feed stop	<p>The activated feed stop is displayed.</p> <p>"Feed stop" is indicated in the feedrate window by means of the symbol "Feedrate not enabled" and is omitted from the program control display. This function is not activated/deactivated under Program Control, but via the "Feed Start/Feed Stop" keys on the machine control panel.</p>

2.5 General operating sequences



Keys

A range of keys are available in the various operating areas and menus. The function of the keys is the same in all operating areas.



This identical functionality applies only if the operating areas are left intact as supplied by Siemens AG and no modifications have been configured by the user.



Additional information

It is possible to customize the menu trees. In this way, users are able to define softkeys according to their individual needs. Due to this capability, the menus and softkeys on your control may be different to those described in this Operator's Guide.



References

Commissioning Manual HMI Advanced,
see Chapter "Generating user operator menus"

Functions

The following section describes functions which you can select in several operating modes.

2.5.1 Program overview and program selection



Function

After selection of a workpiece or program overview, individual workpieces or programs can be enabled or disabled for execution.



Sequence of operations

"AUTO" mode is selected in the "Machine" operating area.
The appropriate channel is selected.
The channel is in reset state.
The workpiece/program to be selected is in the memory.

An overview of all workpiece directories/programs that exist is displayed.
Position the cursor on the desired workpiece/program.

Select the workpiece/program for execution:

Program
selection

The name of the selected workpiece is displayed on the screen in the "Program name" field at the top. The program is then loaded.

2.5.2 Changing the menu window



If a screen comprises several windows, you can use the "Window selection" key to switch between the individual windows. You only need to do this if you wish to enter data on the operator panel front. The focus changes to the selected menu window (the header and border of the active window appear in a different display format).

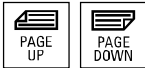

Scroll in menu window:

If the content of a window covers several screen pages, you can use the "Page" keys to scroll up or down through the information.

A scroll bar indicates that the content of the window extends beyond the visible display.

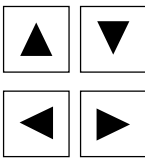

Position cursor in menu window:

You can position the cursor at the desired point in the menu window with the "Direction keys".

2.5.3 Selecting a directory/file



The "Direction keys" can be used to position the cursor on the desired directory/file.

If you enter a character on the alphanumeric keyboard, the cursor moves to the first name that begins with the character.



Open/close directory:

Press the "Input" key to open or close a directory.



Open file:

You can open a file with the "Input" key if you wish to edit it in the ASCII editor. The editor is opened automatically.



Select file

This key is used to select a file. It is possible to select multiple files. The symbol appears next to the cursor bar when a file is selected.



Select multiple files

In order to select a block of files, press the "Shift" and "Cursor down" keys simultaneously.



The first time you press the keys, the start of the block is selected. The subsequent files are selected continuously



until you press the "Cursor up" or "Cursor down" (without "Shift") key.



Deselects a selected file.



Cancels all selections.

2.5.4 Editing inputs/values



If you wish to edit inputs/values, the corresponding key is always displayed automatically on the right of the input field. The following input fields are available:

1. Option buttons (single selection button/multiple option button):

You can use the "Select" key to activate or deactivate a selection field.

Multiple selector button (you can select several options or none)	Single-option button/option button (only one option can be active at a time)
--	---

= active

= not active

= active

= not active

2. Input fields:

Position the cursor on the input field and start to type. When you begin typing, you automatically switch to Insert mode.

Confirm your input with the "Input" key. The value is accepted.

To change an existing value, press the "Edit" key to switch to insert mode.

Enter the value or word (e.g. file name, etc.) on the alphanumeric keypad.

In some fields, it is possible to choose between several preset values by means of the "Toggle" key.

3. Selection list

Selection lists show you a selected value from a list of possible values.

Press the "Edit" key to open a complete list of possible or existing values.

Position the cursor on the value of your choice using the "Direction" keys.





Always confirm your input with the "Input" key. The value is accepted.

With this key, you can switch to the next value in the selection list without displaying the entire list (e.g. to select from only a small number of values/settings).



- The editor displays only the characters which can be input via the operator panel front keyboard.
- A part program opened by the editor cannot be simultaneously started in the NC (enable is canceled); an alarm (14014) is indicated in this case. If the control is switched off while the editor is open, the enable might have to be set manually.

2.5.5 Confirm/cancel input

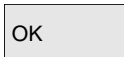

Confirm input:

Your inputs are accepted when you press the "OK" softkey. The selected function is executed. The window is closed, and you return to the menu level from which the window was called.

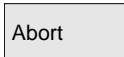

Cancel input:

Your inputs are rejected if you select the "Abort" softkey. The selected function is aborted. The window is closed and you return to the menu level from which the window was called.

This is the same as when returning from a function (vertical softkey bar).



The "Edit" key can also have an "Undo" function if you abandon the input/modification you have just entered. The cursor remains positioned in the currently selected field.



Switch from the horizontal menu level back to the call menu level.

2.5.6 Edit the part program in the ASCII editor



Function

The ASCII editor provides you with the following functions:

- Switch between insert and overwrite mode
- Select, copy, delete block
- Paste block
- Position cursor / find/replace text
- Saving a file
- Create contour (programming support)
- Parameterize cycles (drilling, milling, turning)
- Start simulation
- Recompile (cycles, free contour programming)
- Renumbering blocks
- Change settings
- 2. Open file

Additional information

A part program selected in the NC can generally only be edited when the channel is in the reset state. When a part program is selected and the relevant channel is in the "Channel Reset" state, the program can be fully edited.

The end of block character is not displayed as " L_F "; instead it is displayed as "¶".

Please note:

It is possible to edit a program both directly in the NC and on the hard disk in the ASCII editor. How programs are saved on the hard disk is determined by settings.

Sequence of operations

The following functions are fully enabled in the Program and Services operating areas but only partially in the Machine operating area.

In the Machine operating area, the ASCII editor is called via the program editor, in Services, by selecting a file in the file manager.

You have selected the file you wish to edit in the directory and pressed the "Enter" key, the vertical softkey bar changes. Your selected file is opened in the text editor.

**Cursor block:**

Use the "Direction keys" to position the cursor in the text.

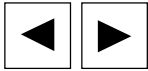

You can page up and down using the "Page" keys.



The character on which the cursor is positioned is deleted.



Press the "Backspace" key to delete the character to the left of the cursor.



Press the "Input" key to end a block. "LF" ("Line Feed") is automatically generated.

Over-
write

Vertical softkeys**Overwrite**

The cursor toggles between insert and overwrite modes.

Mark
block

Select block

When you press this softkey, the vertical softkey bar changes. The softkey marks the beginning of a block.

Now position the cursor at the end of the block.

The block is selected automatically.

Copy
block

This softkey copies the selected block into the buffer.

If a line, which was generated by a support function, is selected the complete support block is copied.

It remains stored in the buffer even if another part program is selected.

Delete
block

The selected block is deleted.

If a line that was generated by a support function is selected the complete support block is deleted.

Mark
block

Selection mode is canceled when you press "Select block".

Paste
block

Paste block

This softkey pastes the cut or copied block from the buffer into the text in front of the cursor position.

Find/
Go to...

Program
start

Program
end

Go to...

Find

OK

Abort

Find
next



Replace



Replace
all texts

Find/Go to...

The "Find/Go to..." dialog box opens. You can select functions for positioning and searching via the vertical softkeys:

The following search methods are available:

- Search to the beginning of the part program (cursor on the first character in the program)
- Search to the end of the part program (cursor on the last character in the program) and
- Proceed to a particular NC block with "Go to.."
- Or search for a particular character string with "Find".

"Go to...": Enter the block number you are looking for.

- If the line being searched for contains an "N" or ":", you are taken to the block in question.
- A message is output if there is no block with the specified number. Press the "OK" softkey or the "Input" key to position the cursor on the block number/line number of your choice.

The "Go to..." window is closed.

If you press "Abort" the positioning process is stopped and the window closed.

"Find":

Enter the character string you wish to find.

The string you enter is sought downwards from the current cursor position, the find result appears as highlighted text.

You can start a new search by pressing the "Find Next" softkey or the "Input" key.

Enter the new text with the "Replace" softkey.

The text found is replaced by the "replacement text". The new text is replaced when you press "Input". Every time you press "Input", a new find and replace process is started.

Enter the new text with the "Replace All" softkey. The query asks you "Do you really want to replace all non-write-protected strings: ... globally with ... ?".

Note:

This function can be interlocked with a password (see Commissioning Manual HMI Advanced).



Abort

The function "Replace All" is only enabled for files located on the hard drive (i.e., not in the NC memory).

If you press "Abort", the Find + Replace process is stopped and the window closed. You are back in "Edit mode" again".

Save
file

Save File

Changes are saved in the file loaded in the editor.

Additional information

Please note that the changes to programs stored in the NC memory take immediate effect.

The save options for the control system can be altered in the "Settings" menu (e.g., save automatically, etc.).
(See Chapter "Startup")

Close
editor

Close editor

When you select the "Close editor" softkey, a dialog box may appear in which you must confirm whether or not to save the changes. The text editor is then closed and the current program overview is displayed again.

Contour

Generate
contour

Horizontal softkeys

Free contour programming

Use the "Contour" and "Generate contour" softkeys to call up the free contour programming function.

Accept
contour

The part program block is inserted in the part programs with the appropriate parameter settings.

Cycle parameterization

The following programming support functions are available:

- Drilling, milling, turning (cycles)
- Contouring (free contour programming)

Drilling

Milling

You can call up the relevant cycle parameter settings via the Drilling, Milling, Turning vertical softkeys.

Turning

Enter the new values for the cycle parameters.

OK

The part program block is inserted in the part programs with the appropriate parameter settings.

Example:

```
CYCLE81 (110, 100, 2, 35)
```



References

Simulation



Recompile

OK

Renumber



References



/PGC/, Programming Guide Cycles

Simulation

The simulation is called (see /BA/, Operator's Guide, Interactive programming or Chapter 6 Program operating area).

The "Simulation" softkey is displayed only if the simulation function can be called in the current operating situation.

Recompile

If program steps (cycle/contour) have already been parameterized but must be changed, you can display and edit the parameter values with their meanings.

Position the cursor in the text editor on the line with the program step (contour/cycle) whose parameters you wish to change.

A screen form containing the parameter settings for the selected cycle/contour appears on the screen.

Change the parameters.

The part program block is automatically inserted in the part program with the new parameter settings.

The block numbering in the program shown in the editor is executed again according to the values defined under the "Settings" softkey.

When using cycle support in the part program, additional comment lines are generated in front of and behind the cycle call and used for recompilation.

These lines start with ;#

When cycles are called that were directly recorded with the editor (or even when "old" cycles are called), this information is missing.

The ;#-lines, which are the additions required for screen form support, are generated during recompilation of these cycle calls. As a result, the length of the part program is expanded by a number of lines.

Commissioning Manual HMI-Advanced: "Expand User Interface" (BE1)

Settings

Settings

Define the following values in the "Editor Settings" window:

- Horizontal scrolling ON/OFF
- Display hidden lines ON/OFF
- Deactivate LF in program
If this setting is selected, a space is displayed in the editor window on the screen in place of the linefeed character. In the file to be edited, the linefeed character is retained.
- Time interval for Automatic Save
When you set Automatic Save, you can also set the time intervals at which text must be saved automatically (applicable only to files on hard disk). If a value $\neq 0$ is entered, the "Save file" softkey is not displayed. If the value 0 is entered, automatic save is not performed.
- Automatic numbering ON/OFF
A new block number is automatically inserted on every new line. If you wish to assign new block numbers to an existing program, use the "Renumber" function.
- Number of first block
- Incrementation of block numbers (e.g. 1, 5, 10)

Setting
contour

The following settings are possible for contour programming:

- Last line
Each time you complete a program step in the contour programming you can insert a text in the last line (e.g., "End of contour").

Additional information

- The coordinate system and the technology to be used are set via the machine data; see Commissioning Manual HMI Advanced.
- Edited programs are automatically enabled after saving.

2.5.7 Switching over the channel



Channel states



Function

It is possible to switch between channels when several are in use. Since individual channels may be assigned to different mode groups, a channel switchover command is also an implicit mode switchover command.

If the selected channel is linked to another NCU (M:N link), the HMI Advanced is also switched over implicitly to the relevant NCU.

When a "Channel menu" is configured, all existing communication links to other NCUs plus the associated channels are displayed on softkeys.

The following three channel statuses can occur in each mode:

1. Channel reset

The machine is in the initial state, e.g., after power-on or after end of program. The initial state is defined by the machine-tool manufacturer in the PLC program.

2. Channel active.

A program has been started, the program is being executed or a reference point approach is in progress.

3. Channel interrupted

The running program or reference point approach has been interrupted.

In this context, a program can be a main program, subprogram, cycle or a series of NC blocks.

There are 3 different switchover levels:

1. Switch to next channel.
2. Switch over configured channel group/channels (1 NCU).
3. Switch to another NCU (with M:N link involving several NCUs).

2.5.8 Packet calculator



Prerequisite:

The cursor is positioned on an input field or input/output field.

Equal key

Switch to **pocket calculator mode**.

In this state, if you enter a basic arithmetic symbol (+, -, /, *) followed by a value (e.g. 13.5) and

then press the input key, the next value entered is calculated with the preceding value.

If the input/output field is opened with the input or equal key, the editor is in insert mode; if the field is opened directly with a character, the editor is in overwrite mode.

Inch/metric conversion

In pocket calculator mode, you can convert numeric values from the metric to inch system by entering "I" and from the inch to metric system by entering "M".

Proceed as follows to convert values:

- Position the cursor on an input field which contains a numeric value or enter a numeric value
- Press the equal key
- Enter the letter "I" (convert to inches) or "M" (convert to metric)
- Press the "input" key, the value is converted.

2.6 Calling the help function



Function

Whenever the help symbol appears in the user response line, this means that additional information can be called via the Help key. A comment appears in the user response line or a dialog box opens.

If, for example, you have made an input error, you can select the HMI Help to access detailed information about the error that has just occurred, e.g. the Diagnostics guide is displayed.

Available help functions include:

- Alarm help:
Detailed information about the alarm or message displayed
- MD help:
Detailed information about the selected machine data or setting data
- Editor help:
Brief information or, if the key is pressed again, detailed information about the command or function indicated by the cursor position.



Page
down

or

Page
up

Next
entry

Follow
cross ref.

Go to...

Zoom +

or

Zoom -

Exit
help

Sequence of operations

Pressing the "Information" key, e.g., in the "Diagnostics" operating area, automatically calls and displays HMI Help information for a currently pending alarm.

You can page through the document with the softkeys "Page up" and "Page down",

you jump to the next hit in the document with "Next entry".

Where there are cross-references to other documents, you can jump to a particular point in that document with this softkey.

You can search for any words in the document with the search function "Go to ...".

With the softkeys "Zoom +" and "Zoom -" you can increase or decrease the zoom factor in the document view.

By pressing "Exit help", you can return to the editor.

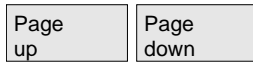

In some cases, help is provided in a similar manner to Windows Help by pressing the following softkeys:

Press the "Page down" or "Page up" softkey.
The display scrolls up or down by a whole page.

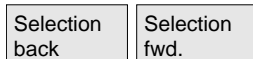

Use the "Selection fwd" or "Selection back" softkeys to go to the entry of your choice.

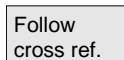

Press the "Follow cross-ref." softkey.
The required entry appears on the screen.



Press the "Back" softkey to return to the previously displayed entry.

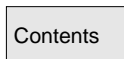

Select and display an entry in HMI Help:

Press "Contents" softkey.
The current contents of HMI Help are displayed.

You exit the HMI Help and return to the previous menu.

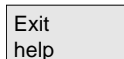

Context-independent Help call:

Press the following keys to call "HMI Help" directly:
"Menu Select" key"



Followed by "ETC" key

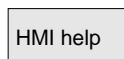

HMI Help

2.6.1 Editor help



Function

The following help functions are available as programming support for editing part programs in the editor via the "information" key:

- **Quick help on program commands**

For configuring, see Commissioning Manual HMI-Advanced :
"Help in the editor" (HE1)

- Help in part program for instructions: Display descriptive text (e.g. G9 "Exact stop - deceleration")
- Display an overview of topics (e.g. "Preparatory functions", "Path commands", "Path traversing behavior", etc.), to which instructions are assigned.
- Display an overview of instructions with descriptive text
- Search selectively in special screen forms on the basis of topic assignment or by entering a character string
- Transfer the selected instruction to the editor

- **Quick help "Parameterization form" + extended help "pdf"**

Configurable parameterization forms from which you can jump to a particular page in the documentation (pdf file), e.g., parameterization forms for cycles, jump to Programming Guide Cycles:

For configuring, see Commissioning Manual HMI-Advanced:
"Expand User Interface (BE1)".

- **Quick help for program commands + extended help "pdf".**

From the context-sensitive help you can jump to the corresponding page in the documentation with the "information" key, e.g. jump to Programming Guide Fundamentals.

2.6.2 Quick help for program commands



Function

You can call up a help function to provide programming support with the editing of part programs via the "information" key. This help function can assist in the following ways:

- Context-sensitive display of instructions plus descriptive text on the basis of the cursor position (e.g., G9 "Exact stop - deceleration")
- Display an overview of topics (e.g. "Preparatory functions", "Path commands", "Path traversing behavior", etc.), to which instructions are assigned.
- Display an overview of instructions with descriptive text
- Search selectively in special screen forms on the basis of topic assignment or by entering a character string
- Jump from the context-sensitive help via the "information" key onto the corresponding page of the documentation, e.g., jump to Programming Guide Fundamentals
- Jump to an input screen with the "Input screen" softkey in which, for example, a cycle is assigned new parameters.
- Transfer the selected instruction to the editor

Notes

If the help function is being used by one editor, it is not available for use by other editors.

Sequence of operations

You can call up a help function to provide programming support with the editing of part programs via the "information" key.

Depending on the current context of the cursor:

- With standard context sensitivity ("displayed if wording is identical"), only the programmed instruction with descriptive text or
- with extended context sensitivity ("displayed if initial wording is the same"), additionally all instructions with the same initial wording or
- if there is no match, a full overview (see below) is displayed.



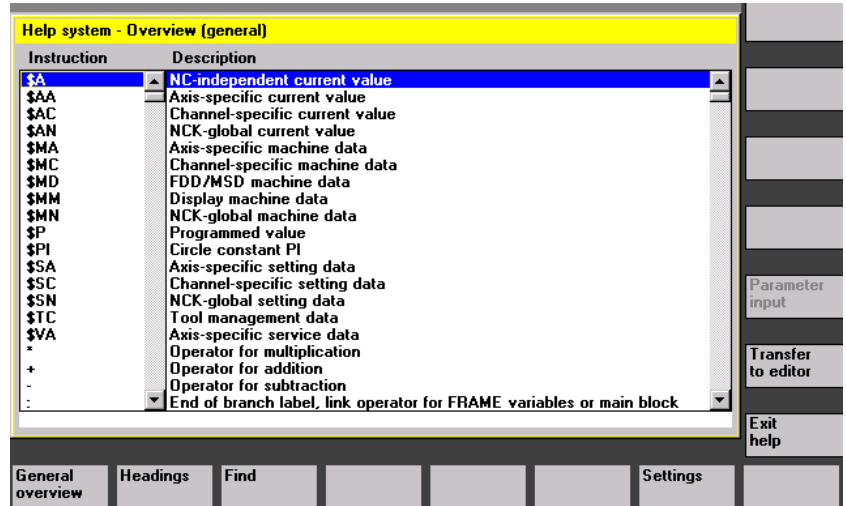

Transfer to editor

If transfer is possible, the instruction selected in the overview is inserted directly in the part program with "Transfer to editor".

If an instruction selected when context sensitivity is active differs from the programmed instruction, the programmed instruction is overwritten.

If extended context sensitivity is not active or if a different selection is displayed with "Find", "Topics" or "General overview", the selected instruction text is inserted in the part program after the instruction marked by the cursor.

Exit help

As an alternative to returning to the editor by transferring an entry, this softkey can be selected to close the Help window and return to the part program writing screen.

Apart from context-sensitive help, it is also possible to search independently of context for instructions, descriptive texts or topics. With "General overview" a full overview of the instructions and relevant descriptive text stored in the help system is displayed.

General Overview

Topics

With "Topics" the stored topics are listed for which a functional grouping of the instructions can be displayed.

To select a topic, you can either use the cursor keys or enter the topic number in an input box.



Display topic

If a topic is selected and you press "Input" or the "Display topic" softkey, the instructions associated with the selected topic are displayed.

 Search

With the "Find" softkey you can define a search text in an input window, which you can search for using

- "Instruction text only"
- "Descriptive text only"
- "Instruction and descriptive texts".

No distinction is made between upper and lower case.



With "Input" or "Start search" a search is made using the defined search text in accordance with the instruction or descriptive part. Any matching instructions or descriptions found during the search are displayed.

 Start search

Notes for setting the help system in the editor

The editor help uses a standard text file (see Commissioning Manual HMI Advanced), which contains topics and instructions with descriptive text.

If you want to create an end user text file for the help in order to record your own instructions/topics, you can enter the path\name of the text file under the "Settings" softkey in an input window as "end user text file".

You can also change the context sensitivity under "Settings".

You can choose between:

- "Display with same initial wording" (extended context sensitivity) and
- "Display with identical wording"

If, for example, in the option "Display with same initial wording" the cursor is located to the right of the instruction "G4", all instructions with the same initial wording, e.g., "G40, G41, G42" are also displayed.

With "Display with identical wording" the current instruction, e.g., "G4" is displayed.

The settings are activated by restarting the help system.



If you select the individual descriptions in the full overview with the cursor key, you can jump directly to the Programming Guide, for example, with the "info" key, if the symbol for the info key is displayed on the bottom right part of the screen (see Fig. below).



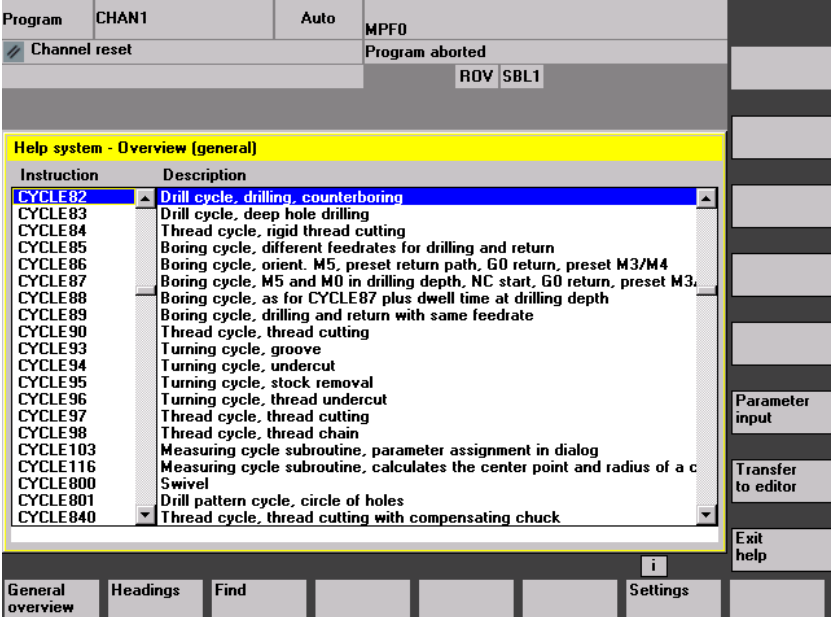

Parameter input

If "Parameter input" appears in the vertical softkey bar, you can assign parameters in an input screen for a particular instruction (e.g., a cycle).

2.6.3 Extended help for program commands



Function

You can call up a help function (quick help) to provide programming support for editing part programs via the "information" key in the program command editor.

If the quick help is not sufficient, you can also open the Programming Guide (pdf file) by pressing the "information" key again. The command you are looking for is highlighted in the document.

Sequence of operations

Prerequisite:

The cursor is positioned on a programming command (e.g. G01).

You can call up the help function (quick help) in the editor using the "information" key.

Press the "information" key again to open the Programming Guide (pdf file) with Adobe Acrobat Reader.

2.7 Job list



Function

A job list (loading list) can be created for each workpiece. This list contains instructions which prepare the following for the execution of part programs (in several channels if necessary):

- Parallel setup (LOAD/COPY), i.e.:
Main programs and subprograms along with associated data such as
 - Initialization programs (INI)
 - R parameters (RPA)
 - User data (GUD)
 - Work offsets (UFR)
 - Tool/magazine data (TOA/TMA)
 - Setting data (SEA)
 - Protection zones (PRO) and
 - Sag/angularity (CEC)load or copy from the hard disk of the PCU to the main memory of the NC.
- Preparations for the NC Start (SELECT), i.e.:
Select programs in different channels as well as starting preparations for execution
- Parallel clearing (reversed LOAD/COPY), i.e.:
Remove/unload main programs, subprograms and associated data from the NC working memory to the hard disk of the PCU
- Backup (in preparation for the next software version)

Notes

Parallel setup, preparations for NC Start, parallel cleanup and backup can also be executed from the PLC.

The job list is executed if the workpiece contains a job list of the same name.

The job list instructions are activated (see diagram) on

1. Parallel setup with "Load" (LOAD/COPY)
1. "Select" (LOAD/COPY/SELECT)
2. "NC Start" (program is executed and SELECT is activated)
3. Parallel clearing with "Unload" (reversed LOAD/COPY)
4. "Backup" (in preparation for the next software version)

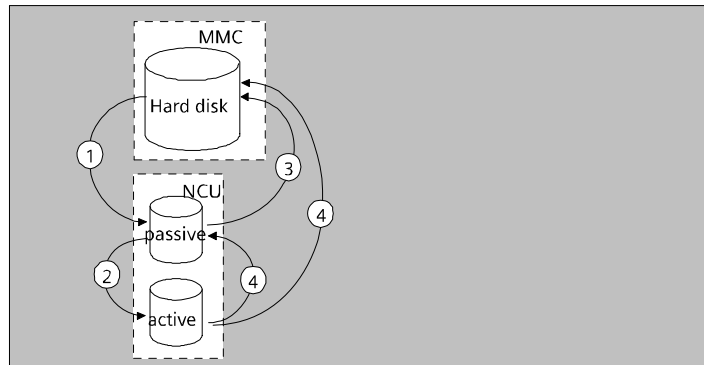

New



Creating the file "Workpiece.JOB" (z.B. SHAFT.JOB)

There are various methods by which job lists can be created:

- While creating a workpiece directory with the function "New", generate a standard job list as a file in this workpiece. The job list syntax is included as a comment in this standard job list. The "Create templates for job list" field under "Startup/HMI/System settings/Templates" must first be checked. With this method, the file is automatically assigned the name of the relevant workpiece directory, `Workpiece.JOB` (e.g. `SHAFT.JOB`).
- Create job lists with different names in an existing workpiece directory with the function "New".
- Job lists can be inserted in an existing workpiece directory. The job list can be modified with the editor.

Notes

You can create your own templates for job lists or standard part programs/subprograms in the directory `\Templates\Manufacturer` or `\Templates\User`. The data manager always searches the User directory first, then the Manufacturer directory, and finally the Siemens directory. Job list templates can be stored according to language and system.

See Programming operating area: 6.1.5 Templates.

2.7.1 Syntax description for job lists



Explanation

The job list syntax consists of 3 instructions

- Load instruction LOAD
- Select instruction SELECT
- Copy instruction COPY (for m:n link only)

Notes

As regards the job list commands, a distinction must be made between an m:n network and a 1:1 link between the HMI and NCs. It is advisable to use the instruction LOAD for a 1:1 link and COPY for an m:n link, at least for global programs and, in particular, cycles used in several NCUs.

Comment

All terms placed inside "brackets" or ";" are comments and are ignored when the job list is processed.

Description of syntax

LOAD [source]

The LOAD instruction loads one or several files from the HMI into the NC working memory, deleting the source file on the HMI. In other words, the files are only stored in one location. This instruction is recommended for a 1:1 link.

[source] is [path]/[name]

The path/name defines the relevant path within the file tree of the data manager.

Wildcards (i.e., *) may also be used in the name.

Examples:

LOAD *

(Loads all files from the workpiece directory of the job list)

LOAD /MPF.DIR/*

(Loads all files from one directory, e.g., in this case all files from part programs (MPF.DIR))

LOAD PART1.MPF

(Loads one file, e.g., PART1.MPF from the currently selected workpiece directory of the job list)

LOAD /SPF.DIR/PART1.SPF



(Loads one file from one directory, in this case from the subprogram directory SPF.DIR)

SELECT [source] [destination] [DISK]

The SELECT instruction selects a program for execution. The selected program must be loaded into the working memory of the NC. It can then be started with NC Start.

If programs on the hard disk must be executed, then the command must include the keyword DISK.

[source]

is the name of the main program which is selected for execution in a specific channel in the NCK.

[destination]

A channel must be specified as the destination.

CH=

Channel number (for a 1:1 link only);

or

with NETNAMES.INI: Channel name (channels are unambiguously distributed across all NCs);

or

NC name, channel number

Example:

CH=2

(2, corresponds to the channel number)

CH=Station5

(Station5, corresponds to channel name from

NETNAMES.INI)

CH=ncu_b,1

(ncu_b, corresponds to the NCU name from NETNAMES.INI

1, corresponds to the local channel number of this NCU)

[DISK]

can be optionally specified for program execution from hard disk.

Examples:

SELECT PART12 CH=CHANNEL22

SELECT PART12 CH=NCU_2,2

(PART2 is selected in the 2nd channel of NCU_2)

SELECT /shaft1.wpd/side1.mpf CH=2 DISK

(Part program PAGE1.MPF of workpiece SHAFT1.WPD is executed from hard disk in the 2nd channel)

COPY [source] [destination]

The COPY instruction copies one or several files from the HMI to an NC working memory. The original files remain stored on the HMI. The COPY instruction is executed only if the relevant file does not yet exist at the destination or if it has a different time stamp.

This instruction is recommended for an m:n link.

If this type of file needs to be modified, it must always be edited on the NC. If the file has been distributed more than once via the job list, and you want the changes to be active in all NCs, you must first unload that file, then edit it, and finally redistribute it via the job list.

[source] is [path]/[name]

[destination] is the NCU/channel address:

The destination can be specified using one of the three address categories. Only the logical name from the NETNAMES.INI file is taken into account.

NC= Name of the NCU

Without NETNAMES.INI, it is only possible to specify the NC name with NC=.

CG= Name of the channel group, i.e., copy in every channel of this group (therefore in all NCs to which the channels are assigned).

Parameter CG can be specified only if a channel menu is configured.

CH= Name of channel

Channel names are only uniquely assigned across all NCs, if a channel menu is configured.

If no destination is specified, the source is copied to the NC currently linked to the HMI. If * is entered as the destination, the source is distributed to all the NCs configured in NETNAMES.INI.

Examples:

COPY * *

(Copies all files from the workpiece of the job list to all NCs that are configured in NETNAMES.INI)

COPY PART12.MPF NC=NCU_2

(Copies one file from the workpiece of the job list to the NC "NCU_2")

COPY /SPF.DIR/PART1.* CG=MILL2

(Copies all files with one name from one directory, e.g., PART1.* from subprograms (SPF.DIR) to a channel group, i.e., to all NCs that have channels from this group assigned to them)

COPY /MPF.DIR/* CH=CHANNEL22

(Copies all files from one directory, e.g., all files from part programs (MPF.DIR) to the NC which has this channel assigned to it.)

2.7.2 Example of a job list with two-channel 1:1 links

**Example**

If only channel1 and channel2 on NCU1 (1:1 link) were involved in machining of the workpiece, then the job list structure would be as follows:

LOAD /MPF.DIR/Gen.MPF

LOAD /Work.DIR/Part1.WPD/WpdGen.MPF

LOAD /Work.DIR/Part1.WPD/ Channel1.MPF

LOAD /Work.DIR/Part1.WPD/ Channel1.INI

LOAD /Work.DIR/Part1.WPD/ K12.MPF

LOAD /Work.DIR/Part1.WPD/ Channel2.MPF

LOAD /Work.DIR/Part1.WPD/ Channel2.INI

LOAD /Work.DIR/Part1.WPD/ K22.MPF

SELECT /Work.DIR/Part1.WPD/Channel1.MPF CH=1

SELECT /Work.DIR/Part1.WPD/Channel2.MPF CH=2

The destination is not specified for loading in a 1:1 link, the current NC is the default.

2.7.3 Example of a job list with multi-channel m:n links



Example

HMI1 to two NCs
 NCU1 with channel1 and channel2
 NCU2 with channel3

Part1.JOB:

```

COPY /MPF.DIR/Gen.MPF NC=NCU1 (or CH=CHANNEL1)
COPY /Work.DIR/Part1.WPD/WpdGen.MPF NC=NCU1
    (or CH=CHANNEL1)
COPY /Work.DIR/Part1.WPD/Channel1.MPF NC=NCU1
    (or CH=CHANNEL1)
COPY /Work.DIR/Part1.WPD/Channel1.INI NC=NCU1
    (or CH=CHANNEL1)
COPY /Work.DIR/Part1.WPD/Ch12.MPF NC=NCU1
    (or CH=CHANNEL1)

COPY /Work.DIR/Part1.WPD/Channel2.MPF NC=NCU1
    (or CH=CHANNEL2)
COPY /Work.DIR/Part1.WPD/Channel2.INI NC=NCU1
    (or CH=CHANNEL2)
COPY /Work.DIR/Part1.WPD/Ch22.MPF NC=NCU1
    (or CH=CHANNEL2)

COPY /MPF.DIR/Gen.MPF NC=NCU2 (or CH=CHANNEL3)
COPY /Work.DIR/Part1.WPD/WpdGen.MPF NC=NCU2
    (or CH=CHANNEL3)

COPY /Work.DIR/Part1.WPD/Channel3.MPF NC=NCU2
    (or CH=CHANNEL3)
COPY /Work.DIR/Part1.WPD/Channel3.INI NC=NCU2
    (or CH=CHANNEL3)
COPY /Work.DIR/Part1.WPD/Ch32.MPF NC=NCU2
    (or CH=CHANNEL3)

SELECT /Work.DIR/Part1.WPD/Channel1.MPF CH=CHANNEL1
SELECT /Work.DIR/Part1.WPD/Channel2.MPF CH=CHANNEL2
SELECT /Work.DIR/Part1.WPD/Channel3.MPF CH=CHANNEL3
  
```

2.7.4 "Execute job list" operating sequence



Manage
data

Load

Selection

Unload



Load

e.g., press the "Manage data" softkey under "Services".
The horizontal and vertical softkey bars change.

Position the cursor on the correct workpiece directory.
Then execute functions

- "Load"
- "Select"
- "Unload"

If a job list named `Workpiece.JOB` is stored in a workpiece directory, then the functions are executed for that job list.
However, the functions can be executed directly on the job list, e.g., if the directory contains job lists that are named differently from the workpiece.

Additional information

"Load" job list

"Load" means that all the prepared job list instructions are executed. The data is distributed from [Source] to [Destination], to the destination NCs with the instruction LOAD or COPY. The workpiece is then marked as "loaded".
SELECT instructions are ignored.
If the workpiece/job list is loaded, then the log window displays a list of the files to be distributed.
The log window can be displayed in the event of an error. Loading of the job list can then be aborted if necessary.

Marking of files on user interface

If the file is stored only on the hard disk of the HMI, then it is marked as "not loaded".
If the file is only located in the working memory of the NC, it is marked as loaded with an "X".
If the file is located both on the HMI and the NC, the identifier "X" is only removed when the files are no longer identical.
If the files have different time stamps or are of different lengths, the identifier is "!X!".

Selection

"Select" job list

If you select a job list or workpiece with job list, all instructions of the job list are executed.

LOAD instructions are executed if the files are still stored on the HMI. COPY instructions are executed only if the files are not stored on the NC or if the file copy on the NC has a different time stamp to the HMI copy. If the time stamps are different, the system asks whether the file should be overwritten.

SELECT instructions are executed.

Unload

"Unload" job list

"Unload" means that the instructions of the job list are "undone", the instructions in the job list are executed in reverse order, e.g.:

Data which have been loaded to a destination NC with a LOAD instruction are unloaded from [destination] to [source] into the source directory on the HMI.

Data which has been loaded to a destination NC with a COPY instruction is deleted in the [destination] if the time stamps are identical. If the file on the NC was changed, the user is prompted whether the version from the NC is to be saved to the HMI.

With "Unload" only files are transferred from the passive file system of the NC. If, for example, modifications have been made to the active data in parameters, these must be saved beforehand.

2.7.5 Re-naming workpieces with job lists



Manage programs...



Rename

Function

When you rename a workpiece directory, all the workpiece files under that directory that have the same name as the directory are renamed. If a job list with the name of the directory exists, the instructions in that job list are also renamed.

Comment lines remain unchanged.

Example:

Workpiece directory `A.WPD` is renamed `B.WPD`:

All files with the name `A.XXX` are renamed as `B.XXX`, i.e. the extension is retained.

If a job list called `A.JOB` exists, it is renamed as `B.JOB`.

If this job list contains instructions of file `A.XXX` and these are located in this workpiece directory, then that file is also renamed `B.XXX`.

Example:

If job list `A.JOB` contains an instruction

```
LOAD/Work.DIR/A.WPD/A.MPF
```

it is renamed as

```
LOAD/Work.DIR/B.WPD/B.MPF
```

However, if a job list contains the instruction

```
LOAD/MPF.DIR/A.MPF or
```

```
LOAD/Work.DIR/X.WPD/A.MPF
```

the files are not renamed.

Sequence of operations

The "Manage programs" softkey in the "Program" operating area must be pressed.

Place the cursor on the workpiece directory that you want to rename.

The "Rename" dialog window opens.

Enter the new name.

2.7.6 Copying workpieces with job lists



This function only applies to the "Program" operating area.
When you copy under "Services", the names remain unchanged.



Sequence of operations

Manage
programs...

The "Manage programs" softkey in the "Program" operating area must be pressed.



Copy

Position the cursor on the file that you want to copy and press the "Copy" softkey.

The file is marked as the source for copying.

Paste

Press the "Insert" softkey, specify another name if required

OK

and confirm with "OK".

2.7.7 Archiving workpieces with job lists in the case of M:N



Function

When archiving workpieces that contain job lists of the same name, in the case of M:N, you are asked whether the job lists to be unloaded are to be executed. You can terminate the action with "Abort", otherwise all job lists are executed and archiving is then started.



Sequence of operations

Data from

In the "Services" operating area, press the "Data from" softkey. The "Programs/Data" file tree is displayed.

The vertical softkey bar changes.

Please refer to Chapter "Reading out data" in "Services" operating area for additional sequences of operation.



Example of Operation

3.1 Typical operating sequence

To provide support for entry-level users or an orientation guide for others, this overview uses a typical operating sequence (from control system power-up to back-up of a user-generated part program) to explain how the functions described can be located.

	Step	In section/ subsection
setting-up	• Switch on machine	1.3
	• Reference point approach	4.3
	• Clamp workpiece/blank	
	• Select tools	
	• Define workpiece zero for coordinates	
	• Enter work offset	5.6.2
	• Enter tool offsets	5.2.7
	• Calculate speeds and feedrates	4.2.4
• Define a reference point (scratching)	4.4.6	
Enter and test a program	• Create part program or	2.6.6
	• Import via external data interface	7.1
	• Select a part program	6.9.5
	• Execute a trial program run (without a tool) <ul style="list-style-type: none"> – Start a part program (e.g., in single block) – Revise part program using program editing function or diagnostics guide/help 	4.2.1 4.6.7 8.2
	• Optimize a part program	6.6
Machining the workpiece	• Use tool	5.3
	• Execute machining program	
Store a program	• Save a part program <ul style="list-style-type: none"> – To hard disk or – Export via external data interface 	6.10 7.2 7.1

Notes

Machine operating area

4.1	CNC data structure	4-85
4.1.1	Modes and machine functions	4-86
4.1.2	Modes group and channels	4-88
4.1.3	Cross-channel status display via symbols	4-89
4.1.4	Two-channel display	4-90
4.1.5	Mode selection, mode change	4-91
4.2	General functions and displays	4-94
4.2.1	Start/stop/abort/continue part program	4-94
4.2.2	Displaying the program level	4-95
4.2.3	Switching over the machine/workpiece coordinate system (MCS/WCS)	4-96
4.2.4	Displaying several transverse axes	4-98
4.2.5	Displaying axis feedrates	4-99
4.2.6	Display G functions, transformations and swivel data	4-100
4.2.7	Displaying auxiliary functions	4-101
4.2.8	Displaying modal M functions	4-101
4.2.9	Displaying spindles	4-103
4.2.10	Handwheel	4-104
4.2.11	Status of the synchronized actions	4-105
4.2.12	Preset	4-107
4.2.13	Setting the actual value	4-108
4.2.14	Inch ↔ Metric switchover	4-109
4.3	Reference point approach	4-111
4.4	JOG mode	4-114
4.4.1	Function and main screen	4-114
4.4.2	Traversing axes	4-117
4.4.3	Inc: Increment	4-118
4.4.4	REPOS (repositioning)	4-119
4.4.5	SI (Safety Integrated): User agreement	4-120
4.4.6	Scratching	4-121
4.4.7	Displaying system frames	4-124
4.5	MDA mode	4-127
4.5.1	Function and main screen	4-127
4.5.2	Saving the program, file function	4-129
4.5.3	Teach in	4-130
4.6	Automatic mode	4-132
4.6.1	Function and main screen	4-132
4.6.2	Program overview	4-134
4.6.3	Loading and unloading the workpiece/part program	4-135
4.6.4	Protocol: Program loading list	4-136
4.6.5	Executing from the hard disk	4-137
4.6.6	Accessing an external network drive	4-138
4.6.7	Program editing	4-140

4.6.8	Setting the block search/search target.....	4-141
4.6.9	Accelerated external block search	4-145
4.6.10	Block search in Program test mode, multi-channel.....	4-148
4.6.11	Overstore.....	4-150
4.6.12	Program control.....	4-152
4.6.13	DRF offset	4-156

4.1 CNC data structure



Environment

HMI

Function

The following components exist:

- NC with part program memory
- HMI with hard disk

Use the "Load" - "Unload" softkeys to transfer the data to the NC or from the NC to the hard disk.

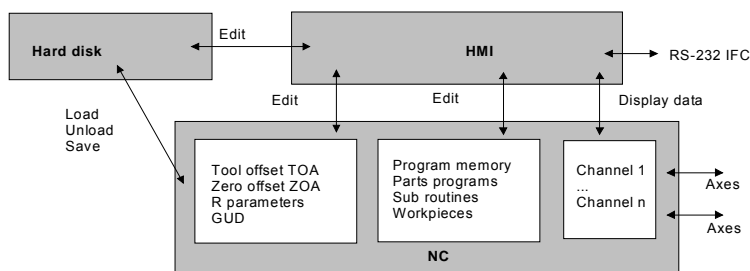

Data in the NC memory are retained when the control power supply is switched off. Only one copy exists of programs that are loaded from the hard disk to the NC memory. The program memory in the NC is limited (see Chapter 9.3 under "NC memory").

4.1.1 Modes and machine functions



Function

The Machine operating area includes all functions and influencing variables which initiate actions on the machine tool or measure its status.

There are three different modes in this area:

- **JOG: JOG is the mode required for manual operation** and setting up of the machine. The setup functions provided are "Reference point approach", "Repositioning", "Handwheel" or "Traverse in preset increments" and "Redefine control zero" (preset).
- **MDA: Semi-automatic operation**
Part programs can be set up and processed block by block in this mode. The tested blocks can then be stored in the part program. In Teach-in mode, positions can be traversed and stored to generate motion sequences, which are then stored in the MDI program.
- **Automatic: Fully automatic operation**
Part programs are executed fully automatically in Automatic mode, i.e., part programs are selected, started, corrected, selectively controlled (e.g., single block) and executed in Automatic.

Select machine area

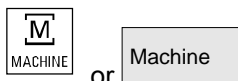

You can switch to the "Machine" area at any time from any of the other operating areas simply by pressing the "Machine area" key.



When you switch on the control, it is usually in the "Machine" operating area and in "JOG" mode.

Please consult the documentation provided by the machine manufacturer!



Machine functions

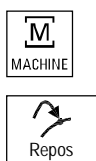

Machine manufacturer

The state after power-up can be configured and might therefore deviate from the default.

In "JOG" mode you can select the following machine functions via the machine control panel or softkeys in the main menu:

Inc (traverse in preset increments)

Repos (repositioning according to a defined position)



Ref (reference point approach to coordinate machine and control zero points)



In "MDA" mode, it is possible to select "Teach-in" (storage of motion sequences in a part program through position approach) by pressing the MCP key.

Preparation for production

To start actual production, some preparatory measures must be taken:

1. Set up the tools and workpiece
2. Traverse the tools/workpiece to the start position specified in the setup plan
3. Download the part program to the control memory
4. Check/enter the work offsets
5. Check/enter the tool offsets

4.1.2 Modes group and channels



Function

Every channel behaves like an independent NC. A maximum of one part program can be processed per channel.

- Control with one channel:
One mode group exists.
- Control with several channels:
Channels can be grouped to form several "mode groups."

Example:

Control with 4 channels, where machining is carried out in 2 channels and 2 other channels are used to control the transport of the new workpieces.

Mode Group1	Channel 1 (machining)
	Channel 2 (transport)
Mode Group2	Channel 3 (machining)
	Channel 4 (transport)

Technologically-related channels can be combined to form a mode group.

Axes and spindles of the same mode group can be controlled by one or more channels.

An operating mode group is in one of "Automatic", "JOG" or "MDI" operating modes, i.e., several channels of an operating mode group can never assume different operating modes.

Channel status via symbol

The channel status and the channel operational messages are output with

symbols in the channel status line:

Channel status

Channel interrupted

Channel active

Channel RESET

Channel operational messages

Stop: Action is required
(e.g., cancel feed disable).



4.1.3 Cross-channel status display via symbols



or



Function

The status of channels, feedrate and spindles are output for a number of channels via symbols in the program status line as well as the machine status, if applicable - or the machine status only.

The machine manufacturer can customize the display; custom symbols can be displayed in addition to the standard symbols.

Initially, this only applies to permanent one-to-one links involving one HMI and one NCK.

Machine manufacturer

Please follow the instructions of the machine manufacturer.

The following SINUMERIK-specific status displays are available:

- Channel status with overlaid spindle and feedrate stop
- Channel status with overlaid feedrate stop
- Channel status
- Spindle status

Significance of colors:

Red Machine/control stopped

Yellow Waiting for operator to take action

Green Machine/control running

Gray Miscellaneous

Channel status

Channel interrupted

Channel active

Channel RESET

Feedrate status

Feedrate is not enabled

Spindle status

Spindle rotating counterclockwise or clockwise

Spindle is not enabled

Spindle stop

Application example with 4 channels and 2 spindles:

Maschine	☐ CHAN1 ☒ CHAN2	AUTO	\WKS.DIR\DAUERTE_CYC950.WPD DAUERTE_NUMBERFEHL.MPF							
Kanal unterbrochen			1	2	3	4	S1	S2		
Halt: Satz in Einzelsatz beendet			SKP1	DRY	ROV	SBL1	M01	M17	DRF	PRT

4.1.4 Two-channel display

Assuming that the following requirements are met, you can display channel information for 2 channels simultaneously with controls for which 2 or more channels have been configured.

Prerequisites

- An M:N assignment is not active
- Two or more channels exist
- The machine data display is set for 2 channels

Representation

Two channels are shown side by side. One of these channels has the focus.

The 1st channel (left pane) is the channel which was explicitly selected in single-pane view. This selection can also be made outside the Machine operating area.

The right-hand pane displays:

- The associated channel configured in netnames.ini in section [MULTICHANNEL] or, if not available
- The subsequent channel configured in the same group in netnames.ini or, if not available
- The channel with the next highest number.

Assuming that the above conditions are met, two-channel display becomes immediately effective when the Machine operating area is started.

Additional information

Two-channel display is simply a **display** method for viewing the channel information. Changes to NC channel data must still be made in the single-pane display. See switchover. As changes to the NC channel data are not entered via two-channel display, no mode-specific softkeys are required if channels in different operating modes are displayed in the left and right panes.

Two-channel view

The division into two channel panes results in new supplementary conditions for the information in each channel pane: In two-channel view

- It is not possible to make entries in the relevant buffers in "MDI" and "Teach-in" modes.
You have to switch to single-channel view to make entries.
- Traversing movements of the axes are not accepted.
- The "program blocks" display is disabled if a part program is being executed from an external source in one of the displayed channels.

For selecting and changing operating modes, please refer to the following chapter.

Single-channel view

If "overstore" is active in single-channel view, the overstore function is explicitly exited on switchover to two-channel view, provided this is permitted by the NC. Otherwise, single-channel view is retained.

Channel switchover is effective for the pane which has the focus. If exactly two channels are configured, the channel windows do not switch places; only the focus changes.

Switchover

The M key will only switch between single-channel and two-channel display in the current Machine operating area.

4.1.5 Mode selection, mode change**Function**

The defined modes for operating a SINUMERIK control system are JOG, MDI and Automatic. They are selected via the MCP or by means of softkeys.

**Machine manufacturer**

Whether the requested mode can be accessed and the manner in which it is accessed can be configured for a specific machine in the PLC program.

Mode change

Not all mode changes are permitted.

An error message is output if a mode change request is rejected by the system. The error message will indicate the error cause and possibly the remedy.



Sequence of operations

Selection of mode

The selected mode is displayed in the mode field on the screen.

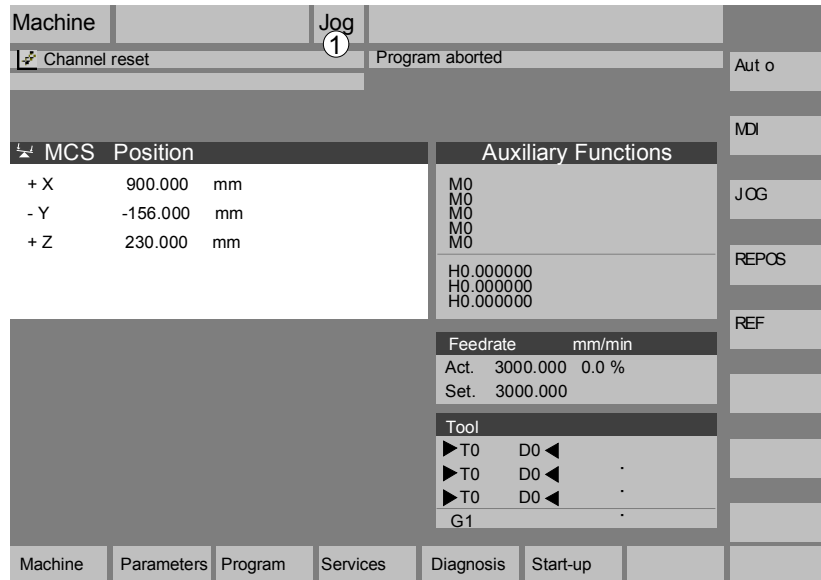

1 = operating mode



To select the modes:

- JOG
- MDA
- Automatic

press one of the keys shown on the left on the machine control panel or

the corresponding vertical softkey, which you can access via the "Menu Select" key:

- JOG
- MDA
- Automatic

When a mode is selected, the LED next to the selection key on the MCP lights up. The same status is signaled in the mode field on the screen.



Additional information

The main screen of the selected mode appears on the screen.

If a mode change is not possible, please contact your installation engineer, the machine-tool manufacturer or our service personnel. In many cases, a mode change is enabled for trained personnel only on safety grounds. To provide this type of protection, the control system offers a facility for disabling or enabling mode changes.

Function Manual Basic Functions: Mode group, channel, program operation, reset response (K1)

4.2 General functions and displays

4.2.1 Start/stop/abort/continue part program



Prerequisite



Cycle Start



Cycle Stop



Reset

Machine

JOG



Repos



...

Function

The following section describes how to start and stop part programs and to resume them after they have been aborted.

Sequence of operations

"AUTO" mode is selected in the "Machine" operating area.

No alarms are pending.
The program is selected.
Feed enable is active.
Spindle enable is set.

Start part program:

The part program is started and executed.

Stop/abort part program:

The program run is interrupted, but can be restarted with "NC Start".

The current program is aborted.

Continue part program:

After interrupting the program ("NC Stop") you can retract the tool from the contour in the mode ("JOG"). The control saves the coordinates of the point of interruption. The distances traversed are displayed.

Repositioning:

Select the "Machine" operating area.

Select "JOG" mode.

Press the "Repos" key to reposition the tool on the contour.

Turning machine:

Press the "+X" or "-X" key.

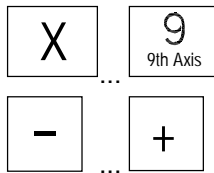
**Milling machine:**

Select the axis to be traversed and

then press the "-" or "+" key.

Traverse the axes to the point of interruption.

4.2.2 Displaying the program level

**Function**

If subprograms are called while a part program is running, the block numbers for the main program and subprograms together with their pass number (P) can be displayed.

**Sequence of operations**

"AUTO" mode is selected in the "Machine" operating area.

When you press the "Program level" softkey, the window headed "Program level" appears instead of the "Current block" window. The softkey labeling changes to "Current block".



Current
block

During execution of a part program, the block numbers for the main program and subprograms, together with their pass number (P), are displayed in the "Program level" window. The main level is always visible, a nesting depth of up to 12 can be displayed.

When you press the "Current block" softkey, the "Current block" window containing the program blocks of the current part program is displayed again.

4.2.3 Switching over the machine/workpiece coordinate system (MCS/WCS)



Function

The display can be toggled between the machine and workpiece coordinate systems by means of special key "MCS/WCS" on the MCP or via softkeys (depending on MCP model and user program). The actual position display for the distance-to-go and the corresponding axes change.

Machine axes

Machine axes are axes that actually exist on the machine and have been parameterized during installation.

Geometry axes and special axes

These are the axes programmed in the part program. Geometry axes and special axes are offset by the selected work offset relative to the machine axes.

Three is the maximum number of Cartesian geometry axes.

MCS

The machine coordinate system (= MCS) refers to the coordinates of the machine axes, i.e., all machine axes are displayed in the machine coordinate system.

Machine position	Repos offset
X	
Y	
Z	

WCS

An offset (e.g., work offset, rotation) can be used to set up a relationship, e.g., with the workpiece clamp. This relationship defines the position of the workpiece coordinate system (= Work) in relation to the machine coordinate system. The workpiece is always represented in a Cartesian coordinate system.

All geometry axes and special axes are displayed in the workpiece coordinate system.

Work position	Repos offset
X1	
Y1	
C1	

Machine manufacturer

Machine data are used to define whether the programmed frames are to be calculated when displaying the WCS (settable zero system = SZS display).

Please consult the documentation provided by the machine manufacturer!







Graphical display of the active coordinate system

Meaning of the symbols (from left to right):

Example:

X1	0.000	mm	0.000
Y1	0.000	mm	0.000
Z1	0.000	mm	0.000
A1	0.000	mm	0.000

 G500			
--	---	---	---

Display of the following transformations:

- Designation of the active work offset (default value: G500).
- Rotation of the geometry axes involved. Without rotation the symbol is invisible.
- Mirroring of the geometry axes involved. Without mirroring the symbol is invisible.
- Scaling of the geometry axes involved. Without scaling the symbol is invisible.

Sequence of operations

"JOG" mode is selected in the "Machine" operating area.

The actual values of the machine axes and their positions are displayed. The softkey label changes to "Act. val. WCS".

The machine coordinate system comprises all the physically existing machine axes. Reference points, tool and pallet change points are defined in the Machine Coordinate System.

When you press the "Act. val. WCS" softkey, the geometry and special axes plus their positions appear in the "Position" window. The softkey label changes to "Act. val. MCS". The workpiece coordinate system is assigned to a specific workpiece. Settings in the NC program refer to the WCS.

- You can also toggle between the workpiece and machine coordinate systems by pressing the "WCS/MCS" key on the MCP.
- The number of places displayed after the decimal point and units of measurement can be set in machine data.

/PG/ Programming Manual Fundamentals



Act. val.
MCS

Act. val.
WCS



WCS MCS



4.2.4 Displaying several transverse axes



Function

Most lathes use one transverse axis in the channel. Special lathes with several transverse axes in the channel are also supported.

Dimensions can be entered and displayed for the diameter simultaneously for known transverse axes in the channel.

Rotary axes are not permitted to serve as transverse axes.

The transverse axes are displayed in three statuses:

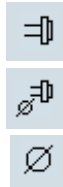

- Axis with constant cutting velocity (G96/G961/G962) where the radius is displayed.
- Axis with constant cutting velocity and where the diameter actual value is displayed.
- Axis where the actual diameter is displayed. Is displayed if the values DIAMON or DIAM90 are active in group G29.

One transverse axis

Constant cutting velocity (G96/G961/G962) is only possible for a transverse axis as geometry axis. When using a transverse axis in the channel – defined using the channel machine data MD 20100: DIAMETER_AX_DEF – there are no changes regarding programming and setting of the machine data.

Several transverse axes

The axis machine data MD 30460: BASE_FUNCTION_MASK bit 2 allows the definition of additional transverse axes, for which axis-specific diameter programming.

MD 30460: Bit2 = 0 Axis-specific diameter programming not permitted.
Axis-specific diameter programming permitted.

Bit2 = 1 This setting is only permitted for linear axes (neither rotary axes nor spindles).

An axis can be simultaneously defined in MD 20100 and in MD 30460 bit2.

Example

The axis Y is a transverse axis where the actual diameter is displayed and axis Z is G96 transverse axis where the actual diameter is displayed.

Actual value window in the machine operator area:

Work	Position	D.-to-go
X	0.000 mm	0.000
Y	0.000 ∅ mm	0.000
Z	0.000 $\frac{\pi}{1000}$ mm	0.000
A	0.000 deg	0.000
G500		

References

Programming Manual, Fundamentals "Special turning functions"

4.2.5 Displaying axis feedrates**Function**

In operating mode "JOG", "MDA" or "AUTO", you can display the current feedrate, residual path information and the associated override data.

**Sequence of operations**

"JOG" mode is selected in the "Machine" operating area.

Press the "Axis feedrate" softkey:

Axis
feedrate

- With "Machine" the feed window is displayed with the current feedrates and distance-to-go information as well as the associated override.
- With "Work" the feed window for the axes taking part in the interpolation is displayed with the current feed and the distance-to-go information with path override; for the remaining axes the current feed and distance-to-go information is displayed with single-axis override.



or

You can use the "Page" keys to display other axes if required.

4.2.6 Display G functions, transformations and swivel data



Function

Active G functions and transformations in the currently active channel can be displayed.



Sequence of operations

"AUTO"/"MDA"/"JOG" mode is selected in the "Machine" operating area.

G-fct.+
Transf.

The window "G Functions + Transformations" with the active G functions and transformations is displayed.



or



Using the "Page" keys you can scroll up and down to display other G functions.



Additional information

Every G group has a fixed location. The group number (no.) and the current G function of the G groups are displayed only if a G function is active.



References

/PG/ Programming Manual, Fundamentals



Swivel data status display

Prerequisite:

The swivel function (CYCLE800) has been set up by the machine manufacturer.

The active swivel data record (orientable toolholder TOOLCARRIER) is displayed concurrently with the transformations.

The following values are displayed:

TCARR = 1 ... n* *n is the maximum number of swivel data items that have been set up (TOOLCARRIER) and are active.



References

/PGZ/ Programming Manual, Cycles: Chapter "Swiveling"

4.2.7 Displaying auxiliary functions



Function

Auxiliary functions that are active in the selected channel can be displayed.



Sequence of operations

"Auto"/"MDA"/"JOG" mode is selected in the "Machine" operating area.

Display
aux. fct.

The "Auxiliary Functions" window appears on the screen.
Up to 5 M functions and 3 H functions can be displayed.

4.2.8 Displaying modal M functions



Function

Modal M functions remain active until they are deleted or overwritten by another command.

M functions are not merely displayed block-by-block, but also remain visible for as long as they are active.

M functions are grouped together (in the same way as G functions, for example), but it is not necessary to display every group.



Display the statuses of modal M functions

The statuses of M functions are displayed as follows:

M08

M function active

M40

M function retrieved during search, but not yet output to PLC

M22

M function output to PLC but not yet acknowledged
(yellow text on black background signifies: Wait)

Window division

5 lines are displayed:

1. Line: Standard M functions:

M03/M04/M05/M19, M7/M8, M40/M41/M42/M43/M44/M45

2. Line: customized, grouped together M functions

3. Line: customized, grouped together M functions

4. Line: non-grouped M functions

5. Line: H functions

The lines are oriented toward the actual value positions.

A maximum of 5 M functions or 5 H functions can be displayed in each line.

Example:

Machine	Position	D.-to-go	Auxiliary functions
X1	0.000 mm	0.000	M03 M08 M40
Y1	0.000 mm	0.000	M10 M16 M22 M32 M51
Z1	0.000 mm	0.000	M53 M56 M61
A1	0.000 deg	0.000	Mxx Mxx Mxx Mxx Mxx
B1	0.000 deg	0.000	H0 H0 H0

Current block		Feedrate (mm/min)	
M30		Act.	0.000 100.0 %
		Set	0.000

Tool	
Preselected tool:	
G01	G40

Over-store	DRF offset	Program control	Block search	Handwheel	Correct program
------------	------------	-----------------	--------------	-----------	-----------------

4.2.9 Displaying spindles

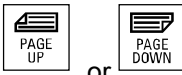

or



Function

The current spindle values (actual speed, setpoint speed, position on oriented spindle stop and spindle override) can be displayed.

Sequence of operations

"AUTO"/"MDA"/"JOG" mode is selected in the "Machine" operating area.

The "Spindle" window appears on the screen.

The window contains the spindle setpoint and actual value, position, setting of spindle override switch and spindle output.

Using the "Page" keys you can scroll up or down to display other spindles - if any are configured.

Additional information

- The "Spindle" window is only displayed if at least one spindle is configured.
- If a master spindle is configured, this is automatically displayed in the spindle window, even if it is not the first spindle.

The following spindle states are output as symbols for the spindles displayed in the spindle window:



"Spindle STOP"



"Spindle is not enabled"



"Spindle direction of rotation counter-clockwise" or "... clockwise" (=spindle running)

4.2.10 Handwheel



Function

Using the "Handwheel" function, you can assign an axis to the handwheels and activate them.

Sequence of operations

"JOG" mode is selected in the "Machine" operating area.

The "Handwheel" window appears on the screen.

Position the cursor on the handwheel of your choice (1-3).

An axis identifier is suggested in the "Axis" field. All other existing axes can be selected via the "Toggle" key. The settings are accepted immediately and an axis is assigned to each handwheel (1-3).

Every time you press the "Toggle" key in the "Active" field you activate or deactivate enabling of the relevant handwheel. The settings become active immediately.

When you turn the handwheel, the assigned axis traverses by the number of increments that have been set for it (Inc keys).

Machine manufacturer

The machine manufacturer is responsible for the design of handwheels. Operation may therefore differ from the explanation above. Please refer to the machine manufacturer's documentation!

4.2.11 Status of the synchronized actions



Synchron.
actions

Function

Status information (such as "enabled", "disabled", etc.) can be displayed here to support commissioning of synchronized actions.

References: /PGA/, Programming Guide Advanced, Chapter "Synchronized actions"

Sequence of operations

"AUTO"/"MDA"/"JOG" mode is selected in the "Machine" operating area.

Press the "ETC" key followed by

the "Synchroniz. actions" softkey.

The display "Status of synchronized actions" appears.

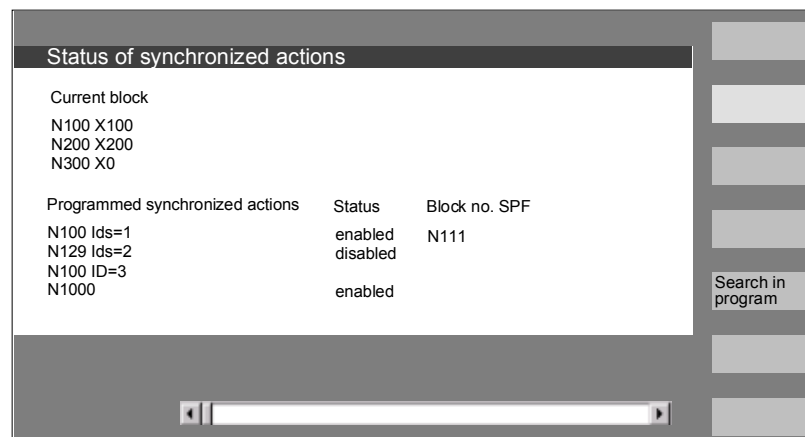

The display shows:

- **"Current block"** column:
Current section of selected part program:
Preceding, current and following block
- **"Programmed synchronized actions"** column:
The programmed synchronized actions are listed block by block with block number (static/modal actions are listed together with the number of the synchronized action)

- **"Status"** column:
 - " " (no information given)
the condition is checked in the interpolation cycle.
 - "disabled"
LOCK was set from the PLC for the synchronized action
 - "active"
The action is currently being executed. If the instruction part of a programmed synchronized action starts a subprogram/cycle, the current block number of the cycle is additionally displayed in the "Block number SPF" column.



Search in
program

A window opens:

Here you must enter the system variable/synchronized action of your choice.

The control searches the current or an additionally specified program for synchronized actions which match the current block and synchronized action numbers.

If the control finds matching program blocks, the associated condition and instruction parts are also shown on the main screen along with the other data.



Press RECALL to return to the "Automatic" main screen.

4.2.12 Preset



Preset



Function

Resetting the actual value
A new position value is entered for the current axis positions.

Danger

After the actual value has been reset, none of the protection zones or software limit switches are operative! The protection zones and software limit switches are only reactivated following another reference point approach.

The "Preset" function can be used to redefine the control zero in the machine coordinate system.
The preset values act on machine axes.
Axes do not move when "Preset" is active.

Machine manufacturer

See machine manufacturer's specifications.

Sequence of operations

"JOG" mode is selected in the "Machine" operating area.

The "Preset" window appears on the screen.

Enter the new actual value, which must in future correspond to the current axis position, for each individual axis. By doing so, you are redefining the control zero in the MCS. When the control zero is redefined, the tool change point, for example, also changes.

Additional information

Machine manufacturer

The "Preset" function can be disabled by means of protection levels (keylock switch position).

4.2.13 Setting the actual value



References

Set act.
value

1

9

...



Abort

Function

The "Set actual value" function is now available via display machine data 9422 as a functional alternative to the existing "Preset" function. The "Set actual value" function can be used only if the control is operating in the workpiece coordinate system.

The functions are stored under the same softkey.

This function sets the workpiece coordinate system to a defined actual coordinate. The resultant offset between the old actual value and the newly entered WCS actual value is computed in the system frame or basic frame defined by the machine manufacturer.

Machine manufacturer

See machine manufacturer's specifications.

Commissioning Manual HMI Advanced

Sequence of operations**Prerequisite:**

The function can only be invoked when G500 and Work (WCS) are active.

The new position setpoint of the axes in the workpiece coordinate system can be entered using "Set actual value" in the actual value window. When you transfer a value to the system by pressing "Input", the deviation from the current actual value is entered in the basic frame or system frame. The new actual value is displayed in the "Position" column.

	WCS	Position	
X		20.000	mm
Y		10.000	mm
Z		120.0	mm
U		0.000	grd
V		0.000	mm

Using "Abort", you can undo the entire offset entered up to now and exit the input screen.

4.2.14 Inch ↔ Metric switchover



Switch to
metric



References

Function

The control can work with imperial inches or metric units of measurement. You can switch between imperial inches and metric units of measurement in the "Machine" operating area. The control converts the values accordingly.

In order to convert the channel-specific values in the machine data, display machine data 9014 must be set to 1.

Machine manufacturer

The switchover is only possible if:

- The corresponding machine data have been set.
- All channels are in the Reset state.
- Axes are not traversing with JOG, DRF or PLC control.
- Constant grinding wheel peripheral speed (GWPS) is not active.

Display machine data 9011 is used to define the display resolution for the imperial units of measurement (inches).

Actions such as mode change or part program start are disabled for the duration of the switchover.

Sequence of operations

"AUTO"/"MDI"/"JOG" mode is selected in the "Machine" operating area.

Press the "ETC" key followed by

the "Switch to metric" softkey.

When the measuring system is changed, all length-related parameters are automatically converted to the new measuring system from the perspective of the user.

If the switchover cannot be performed, this is indicated by a message on the user interface.

Function Manual Fundamentals, G2 Chapter "Metric/inch measuring system"



Warning

If several NCUs are linked by NCU-link, the switchover has the same effect on all linked NCUs. If the prerequisites for a switchover are not fulfilled on one of the NCUs linked, no switchover will take place on none of the NCUs. It is assumed that interpolations between several NCUs will take place on the existing NCUs, whereby the interpolations can provide correct results only if the same unit systems are used.



References

Function Manual Extended Functions, Distributed Systems (B3)

4.3 Reference point approach



Ref Point



Function

The "Ref Point" function ensures that the control and machine are synchronized after Power ON.

Before a reference point approach can be carried out, the axes must be located at positions (if necessary, traversed to these positions using the axis keys/handwheel) from where the machine reference point can be approached without collision.

If reference point approach is called from a part program, all axes can be traversed simultaneously.

Reference point approach can only be performed by machine axes. The actual value display does not match the real position of the axes when the control is switched on.

Caution

- If the axes are not safely positioned, you must traverse them to safe positions in "JOG" or "MDI" mode.
- You must follow the axis motions directly on the machine!
- Ignore the actual value display until the axes have been referenced!
- The software limit switches are not active!

Sequence of operations

"JOG" or "MDI" is selected in the "Machine" operating area. The channel for reference point approach is selected.

The "Ref Point" machine function is selected.

Turning machine:

Press the "Axis" keys.

Milling machine:

Select the axis to be traversed and

then press the "+" or "-" key.



Machine manufacturer

The selected axis moves to the reference point. The direction and sequence is defined by the machine manufacturer in the PLC program.

If you have pressed the wrong direction key, the action is not accepted and the axes do not move. The display shows the reference point value.

No symbol is displayed for axes that are not referred to a reference point.



This symbol is displayed for axes that need to be referenced.



This symbol is shown next to an axis if it has been referenced.



The axis, once started, can be stopped before it reaches the reference point.

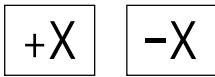

Turning machine:

Press the "Axis" keys.



Milling machine:

Select the axis to be traversed and



then press the "+" or "-" key.

The selected axis moves to the reference point.



Caution

The machine is synchronized as soon as the reference point is reached. The actual value display is set to the reference point value. The display is the difference between the machine zero and the slide reference point. From now on, path limits, such as software limit switches, are active.

You can end the function by selecting another operating mode ("JOG", "MDI" or "Automatic").

- All axes of a mode group can approach the reference point simultaneously (depending on the PLC program of the machine-tool manufacturer).
- The feedrate override is active.





Machine manufacturer

Your machine manufacturer will instruct you how to select axes if you intend to enter more than nine.



Additional information

The sequence in which axes must be referenced can be defined by the machine-tool manufacturer.

The NC cannot be started in Automatic mode until all axes with a defined reference point (see machine data MD) have actually reached this point.

4.4 JOG mode

4.4.1 Function and main screen



Function

In manual mode you can:

1. Synchronize the control measuring system with the machine (reference point approach),
2. Set up the machine, i.e., activate manually-controlled motions on the machine using the keys and handwheels provided on the machine control panel.
3. Activate manually-controlled motions on the machine using the keys and handwheels provided on the machine control panel while a part program is being interrupted.

The following "JOG" main screen is displayed when you press the "Menu Select" key

followed by the "JOG" key.

The "JOG" main screen contains values relating to position, feedrate, spindle and tool.

Machine		Jog			
<input checked="" type="checkbox"/> Channel reset		Program aborted		G. fct. + transf.	
				Display aux. funct.	
MCS	Position	Repos offset	Master spindle S1		Spindles
-X	90.646 mm	0.000	Act. +	0.000 rpm	Axis feedrate
+Y	113.385 mm	0.000	Set	0.000 rpm	
+Z	109.131 mm	0.000	Pos	0.000 deg.	Zoom Act. val.
+V	0.000 mm	0.000		0.000 %	
			Power [%]		
			Feedrate mm/min		
			Act. 7000.000 0.000%		Act. val. WCS
			Set 7000.000		
			Tool		
			Preselected tool:		
			G0 G91		
Preset		Scratch		Handwheel INC	

Explanations relating to the JOG main screen



WCS
+ X2*
Y2*
Z2*

Displays the addresses of the existing axes with the machine axis identifier (MCS) or with the geometry axis identifier (WCS).
(see also Section "Toggle between machine/workpiece coordinate system (MCS/WCS)")



Machine manufacturer

Machine data are used to define whether the programmed frames are to be calculated when displaying the WCS (settable zero system = SZS display).

Please consult the documentation provided by the machine manufacturer!



- If the axis identifier can only be displayed in an abbreviated form, this is indicated by the character .
- If you traverse an axis in the positive (+) or negative (-) direction, a plus or minus sign is shown in the relevant field.
The axis is in position if neither + nor - is displayed in the position display.

Position

0.0
0.1
-0.1
1.1
0.0

The actual position of each configured axis in the machine (MCS) or work (WCS) is displayed in these fields.

The sign is only displayed for negative values.

Repos. offset

0.0
0.1
-0.1
1.1
0.0

If the axes are traversed in the "Program interrupted" status "in "JOG" mode, the path traversed by every axis with respect to the point of interruption is displayed in the REPOS offset.

Spindle

**Spindle window** (if spindle is available)

The window contains the setpoint and actual values for the spindle speed, the spindle position, setting of the spindle override switch and spindle output.

Nibbling

The spindle window is replaced by a nibble window if the "Nibbling" technology option is set.

The active function, if any, appears at the top left in the window header:

- PON Punching ON
- SON Nibbling ON
- SPOF Punching/nibbling OFF

Feedrate

**Feedrate window**

Display of the setpoint and actual value of the feedrate as well as the position of the feedrate override switch (in %). The actual setpoint to be traversed is dependent on the override switch.

When G00 (rapid traverse movement) is programmed, the rapid override value is displayed.

If the feedrate is not enabled, the symbol "Feedrate not enabled" is output in the feedrate window. (FST is not indicated in the "program control display" field).



Tool

Tool window

Display of active tool offset (e.g., D1), tool currently in use (T no.), preselected tool (on milling machines) plus currently active motion commands (e.g., G01, SPLINE, ...) or tool radius compensation not active (e.g., G40).

The following values are displayed:

- The "Path section" and "Stroke rate" are displayed in reverse video if you have programmed the automatic block division with "Path section length" or "Number of path sections".
- The "delay time" can only be displayed if you have set "Punching with delay time".

Increases the size of the actual-value display.

Zoom
act. val.

4.4.2 Traversing axes

Traverse rate

The initial settings for traverse rate and feed mode are stored in setting data for JOG mode.

Traverse rates are defined by the machine manufacturer. The default setting for the feedrate is mm/min.

See operating area "Parameters/Setting data/JOG data".



Sequence of operations

"JOG" mode is selected in the "Machine" operating area.

Traversing axes

Using the "Inc" (increment, see Subsection 2.2.2) function, manually traverse the selected axis in preset increments in the appropriate direction by pressing an "Axis key" repeatedly:

- [.] Variable increment can be set via the "Inc" softkey.
- [1], [10], ..., [10000] fixed increment

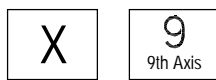
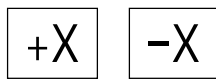
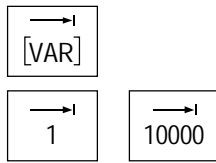

Turning machine:

Press the "Axis" keys.

If necessary, set the rate with the override selector.

If you press "Rapid traverse override" at the same time, you can traverse the axis in rapid traverse mode.

Milling machine:

Select the axis to be traversed and then press the "-" or "+" key.

Feedrate and rapid traverse override switches can be operative.

One or several axes can be selected at the same time (depending on PLC program).





Additional information

- When the control is switched on, the axes can be traversed right up to the limits of the machine as the reference points have not yet been approached and the axes referenced. Emergency limit switches might be triggered as a result.
- The software limit switches and the working area limitation are not yet operative!
- The feedrate enable must be set (FST display must not light up in the program control display).

Machine manufacturer

If no advantage is to be gained from moving several axes simultaneously, the machine manufacturer must implement the appropriate interlock in the PLC program.

4.4.3 Inc: Increment



INC

→
[VAR]

Function

The "Inc" (increment) function can be used to enter a settable increment value for Inc variable traversing.

Sequence of operations

"JOG" mode is selected in the "Machine" operating area.

The "Increment" window appears on the screen.

Enter the desired increment.

Press this key in manual mode together with the "Axis" key to traverse the selected axis in the appropriate direction in accordance with the increments set above (see also Section "Traversing axes"). Increment keys with preset increment sizes are temporarily inoperative.

4.4.4 REPOS (repositioning)

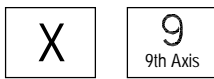
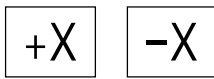

Function

After a program interruption in Automatic mode (e.g., to take a measurement on the workpiece or to compensate tool wear values or after tool breakage), you can retract the tool manually from the contour after selecting "JOG" mode. In such cases, the control stores the coordinates of the point of interruption and displays the path distances traversed by the axes in "JOG" mode as a "Repos" offset in the actual value window.

"Repos" offsets can be displayed in the machine coordinate system (MCS) or workpiece coordinate system (WCS).

Sequence of operations

"JOG" mode is selected in the "Machine" operating area. The axes have been moved away from the point of interruption.

Select machine function "Repos".

Turning machine:

Press the "Axis" keys.

Milling machine:

Select the axis to be traversed and then press the "-" or "+" key.

It is not possible to overtravel the point of interruption. The feedrate override switch is active.

Warning

The rapid traverse override key is active.

Non-compensated Repos offsets are compensated with programmed feedrate and linear interpolation on switchover to Automatic mode and selection of NC Start.

4.4.5 SI (Safety Integrated): User agreement



Function

If the option "user agreement" is installed on the NC, you must enable or disable the function depending on the keylock switch position in "Approach reference point" mode.



User agreement can only be granted if keylock switch position 3 or higher applies in respect of the access level.

The displayed values always refer to the machine (MCS).



Sequence of operations

"JOG Ref" mode is selected in the "Machine" operating area.
The channel to be referenced is already selected.

User
agreement

Press the "User agreement" softkey.

The "Confirm Machine Positions" window is opened.

The machine axes in the MCS are displayed, together with the current position and a checkbox for activating/deactivating user agreement.



Machine axes that do not have to be referenced are shown inverted:
With their current position, but without check box.

Position the cursor on the desired machine axis.



Activate or deactivate user agreement for the selected machine axis
via the "Toggle" key.



Check whether the axis is referenced. If not, error message "Please
reference axis first" is output. User agreement cannot be activated for
the axis until it has been referenced.



References

Additional information

The user agreement function is only provided if user enabling is required for at least one axis of the channel.

/FBSI/, Description of Functions SINUMERIK Safety Integrated.

4.4.6 Scratching



Scratching

Notes

Depending on the machine data configuration, two scratching modes are possible.

Function

You can determine the work offset by "scratching" the workpiece, taking an (active) tool and, if necessary, the basic offset into account. A window is provided for the "Scratching" function.

Sequence of operations

1. Press the "Scratch" softkey:
The softkey will only be made available if you are entitled to use it (machine data).
 - The active plane is displayed and can be altered.
 - The active NV is displayed and can be changed.
 - The active tool is displayed. No tool is displayed if none is active (message).

Machine	CHAN1	JOG	\MPF_DIR TEST_ULI.MPF		57 1523216
Channel reset					
Program aborted			RDV		
WCS	Position	Repos offset	Spindle		S2
X	200.000 mm	0.000	Act.	0.000 rpm	
Y	25.800 mm	0.000	Set	0.000 rpm	
Z	0.000 mm	0.000	Pos	0.000 deg	
B	0.000 deg	0.000		100.000 %	
C	0.000 mm	0.000	Power [%]		
Scratch					
Plane	G17	T no.	3		
Zero offset	G500	Cut edge	1		
Axis Offset	Setpt. pos.	Geo. + wear	Base		
X	234.000	-234.000 + R	0.000	+ L3	0.000 mm
Y	384.000	-384.000 + R	0.000	+ L2	0.000 mm
Z	0.000	0.000 L1		L1	mm
C		0.000			mm
					Abort
					OK

Meanings of columns in the "Scratch" window:

- "Offset": Current value of offset to be determined. The coarse offset is displayed; the fine offset is taken into account and remains valid.
- "Position setpoint": Input of subsequent position setpoint for scratched edge.
- "Approach direction": selection fields for positive/negative approach direction

- Use the cursor to select the first axis to be traversed in the "Scratch" display.
Selected axes are automatically marked in parallel in the actual value window.
- Traverse the axis up to the workpiece, enter the chosen position setpoint (e.g., "0") and press the "Input" key. The offset is then calculated.
Repeat the process for other axes.
- Press "OK" to transfer all values to the selected WO. The offset is always calculated in relation to the current work (WCS).
- To ensure that allowance is made in the tool geometry (or the tool base dimension), position the cursor in the "Approach direction" column on the axis to be altered and press the "Toggle key" so that the desired approach direction is visible.



Example 1:

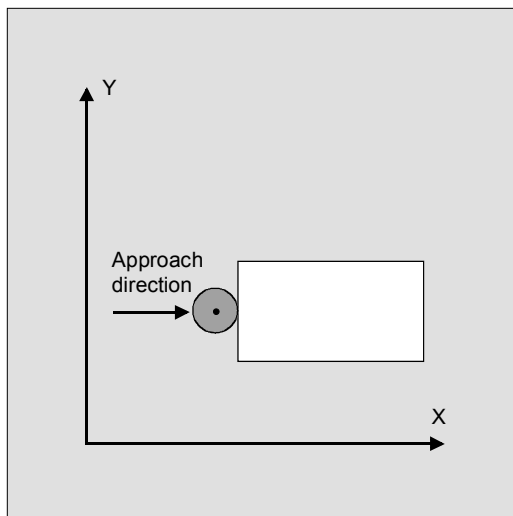

Set "+R" with toggle key.

The figure below shows how system frame \$P_SETFR is displayed as the line "Set work offset".

Parameter	CHAN1	Jog	MPF0	
Channel reset			Program aborted	Axes +
Change active work offsets and compensations				Axes -
			X [mm]	Y [mm]
Set zero	Coarse		-20.000	-30.000
	Fine		0.000	0.000
Ext. WO frame	Coarse		0.000	0.000
	Fine		0.000	0.000
Tool holder	Coarse		0.000	0.000
	Fine		0.000	0.000
1.global base WO	Coarse		0.000	0.000
	Fine		0.000	0.000
1.chan-spec. base WO	Coarse		0.000	0.000
	Fine		0.000	0.000
Tool reference	Coarse		0.000	0.000
	Fine		0.000	0.000
Work pc. ref.	Coarse		0.000	0.000
	Fine		0.000	0.000
Frame cycles	Coarse		0.000	0.000
	Fine		0.000	0.000
Decimal no.inp.: only nos, "." and "-" allowed				
Tool compens.	R variables	Setting data	Work offset	User data
				Active WO + compens.

Toolholder

If a toolholder is active in the present system, it is displayed in the G function window as "TCARR=n" (n = 1 or 2).

Maschine	KANAL1	JOG	SYF.DIR OSTORE1.SYF	
Kanal unterbrochen			Programm unterbrochen	
NC-Satz-Fehler / Anwenderfehler			ROV	
14155 ↓ Kanal 1 Satz ungueltige Baseframedefinition fuer Werkzeugtraegeroffset				
WKS	Position	Repos-Versch.	Transformation + G-Funktionen	
X1	0.00 Ømm	0.00	TCARR = 1	
Z1	0.00 mm	0.00	01:G01	
CK1	0.00 grd	0.00	04:STARTFIFO	
CK3	0.00 grd	0.00	06:G18	
XK3	0.00 mm	0.00	07:G40	
			08:G54	
			10:G60	
			12:G602	
Ankratzen				
Ebene	G18	Schneide	1	
Nullpunktverschiebung	G54		1	
Achse	Verschieb.	Sollposition	Anfahrriichtung	Werkzeugkorrektur
X1	0.00		→	- R 0 mm
Z1	0.00		→	- R 0 mm
CK1	0.00			Grad
CK3	0.00			Grad
XK3	0.00			mm
Schwenken: Abgleich nicht möglich				

Swivel
adjustment

With scratching in a swiveled level with rotary axes without encoder, the "Swivel adjustment" vertical softkey appears in addition to the toolholder information in the "Transformations + G functions" window. Upon activation, the NC updates the toolholder data after scratching. If this operation is successful, "Swivel adjustment completed" is output in the message line. If an error occurs, e.g. the channel is in "active" state or the connection with the NC is disrupted, "Swiveling: adjustment not possible" is displayed in the message line.

4.4.7 Displaying system frames



If system frames have been activated via MD, they can be displayed via the Parameters operating area, Active WO + Override, Details.

The following assignment is applicable:

\$P_SETFR	System frame for actual value setting, scratching
\$P_EXTFR	System frame for work offset external
\$P_PARTFR	System frame for TCARR and PAROT
\$P_TOOLFR	System frame for TOROT and TOFRAME
\$P_WPFR	System frame for workpieces
\$P_CYCFR	System frame for cycles

Both the offset set via frames (coarse and fine) and the rotation and mirroring defined there are displayed. Display is according to the position in the frame chain.

You can choose between the system frames and basic frames by scrolling through the desired section.

The following figure shows an example screen layout:

Parameter	CHAN1	Jog	MPF0
Channel reset			Program aborted
Change active work offsets and compensations			
		X [mm]	Y [mm] Z [mm]
1.chan-spec. base WO	Coarse	0.000	0.000 0.000
	Fine	0.000	0.000 0.000
Tool reference	Coarse	0.000	0.000 0.000
	Fine	0.000	0.000 0.000
Work pc. ref.	Coarse	0.000	0.000 0.000
	Fine	0.000	0.000 0.000
Frame cycles	Coarse	0.000	0.000 0.000
	Fine	0.000	0.000 0.000
Prog. WO	G58/TRANS	0.000	0.000 0.000
	G59/ATRANS	0.000	0.000 0.000
Act. tool	T no.	0	D no. 0 Plane G17
Lengths	Geometry		
	Wear		
	Base		
Radius	Geometry		
	Wear		
Decimal no.inp.: only nos, "." and "-" allowed			
Tool compens.	R variables	Setting data	Work offset
		User data	Active WO + compens.



Protection levels for system frames

The machine manufacturer or user can assign the appropriate protection levels for system frames as well as for individual functions and data areas using display machine data.

Default:

These machine data are assigned protection level 7 by default during the standard commissioning procedure. This means that access is granted to all these data areas and functions when the keylock switch is in the 0 position.

If required, these protection levels can be changed by the machine manufacturer or user. Protection levels 0 to 3 can also be entered.

Protection levels are available for the following system frames:

System frame	MD number	Name/description
ToolFrame	9183	\$MM_USER_CLASS_WRITE_TOOLFRAME Protection level write toolholder
PartFrame	9184	\$MM_USER_CLASS_WRITE_PARTFRAME Protection level write tool reference point
WPFrame	9185	\$MM_USER_CLASS_WRITE_WPFRAME Protection level write workpiece reference point
CYCFrame	9186	\$MM_USER_CLASS_WRITE_CYCFRAME Protection level write cycle frame
TraFrame	9187	\$MM_USER_CLASS_WRITE_TRAFRAME Protection level write transformation frame
ExtFrame	9188	\$MM_USER_CLASS_WRITE_EXTFRAME Protection level write external WO
SetFrame	9210	\$MM_USER_CLASS_WRITE_ZOA Protection level write settable WO

Note:

In the case of SetFrame, the same machine data applies as for settable work offsets, as this practically does constitute a work offset. This also applies to SetFrame fine offset, in respect of which no user intervention is permitted. For fine offset of the settable work offsets, there is a dedicated machine data:

9203 \$MM_USER_CLASS_WRITE_FINE. The associated protection level is generally lower than for coarse offset.

Further information:

Set zero point corresponds to \$P_SETFR
 Ext. WO frame corresponds to \$P_EXTFR
 Toolholder corresponds to \$P_PARTFR
 Tool reference corresponds to \$P_TOOLFR
 Workpiece ref. corresponds to \$P_WPFR
 Cycles corresponds to \$P_CYCFR

See also Subsection 4.4.6

4.5 MDA mode

4.5.1 Function and main screen

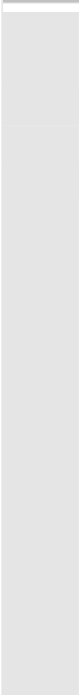
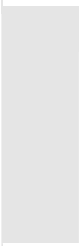

Teach In

Function

In "MDA" (Manual Data Automatic) mode, you can write part programs block by block and execute them. You can transfer the required motions as single part program blocks to the control using the operator panel. The control processes the entered program blocks when you press the "NC Start" key.

Caution

The same safety interlocks must be applied as used in fully automatic operation. The same preconditions must be fulfilled as for fully automatic operation.

The automatic functions (traverse blocks) are active in "MDA" mode.

The functions associated with "JOG" are active in submode "Teach-in" and can be accessed via an MCP key. You can therefore create and store a program in the input and manual modes by alternating between "MDA" and "Teach-in".

You can use the editor to edit the program blocks in the MDA window. You can view blocks that have already been executed by paging upwards.

Blocks that have already been executed can only be edited in the Reset state. Further blocks can be added with "Input".

Blocks can only be input and executed with the channel in the "Channel Reset" or "Channel interrupted" state.

The program created in MDA mode can be saved in the part program directory (MPF.DIR).

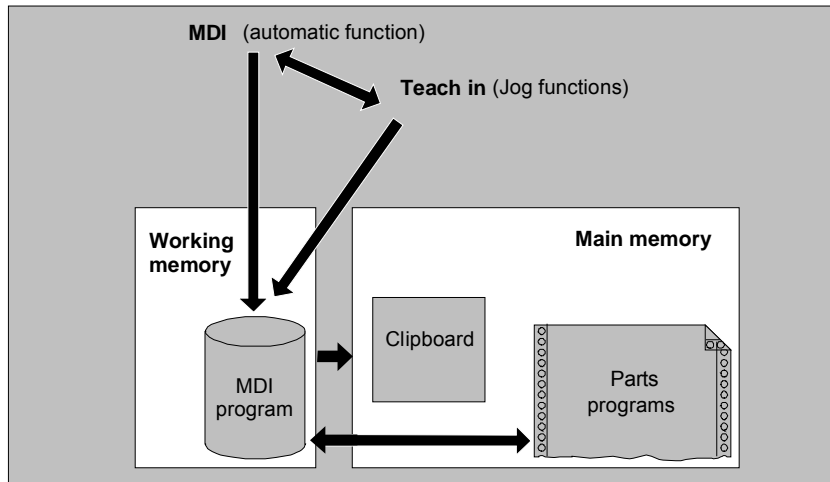

The "MDA" main screen contains values relating to position, feedrate, spindle and tool as well as the contents of the MDA buffer.

Machine	CHAN1	MDI	\SYF.DIR OSTORE1.SYF	
	Channel active		Program running	G fct. transf.
				Auxiliary functions
	MCS	Position	Dist.-to-go	Master spindle S1
	-X	90.301 mm	9.699	Act. + 0.000 rpm
	+Y	80.081 mm	9.919	Set 0.000 rpm
	+Z	0.000 mm	0.000	Pos 0.000 deg.
	+V	0.000 mm	0.000	0.000 %
				Power [%] <input type="text"/>
MDA- program				Feedrate mm/min
	N51 Y0 H55=99			Act. 7000.000 0.000 %
	Y120 F7000			Set 7000.000
				Tool
				preselected tool:
				G0 G91
				Act. val. WCS
				Delete MDI buffer
				MDI file fct.
			Program control	Handwheel Editor function

Explanation of "MDA" main screen

Save MDA prog.

Editor functions

MDA file fct.

As with the JOG main screen, the actual value window, spindle window, feedrate window and tool window are output.

The "Store MDA program" softkey copies the MDA program to the clipboard.

Press this softkey to access functions via vertical softkeys that will facilitate the editing process:

Overwrite, Mark, Copy, Paste, Delete, Find, Find Next, Position. You can save the MDA buffer contents or copy a part program to the MDA buffer for editing in MDA or Teach-in.

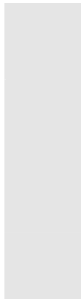

Delete
MDA buffer

Vertical softkeys

Like the JOG main screen, the MDA main screen contains softkeys "G Fct.+Transf.", "Auxiliary functions" and "Spindle" (if spindle is configured).

The contents of the MDA program in the NC are erased.

4.5.2 Saving the program, file function

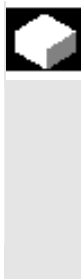

Function

You can use the MDA file function to

- Save the contents of the MDA program to a file or
- Read a part program to the MDA clipboard to edit it in MDA or Teach-in mode.



Sequence of operations

"MDA" mode is selected in the "Machine" operating area.

The program overview of "Part programs" is opened, a dialog window also appears.

The new file is then displayed in the program overview.

The program overview of part programs is displayed. From the list of programs, select the one that you wish to copy to the MDA buffer with "Read in MDA". This can now be edited accordingly.

The system will ask you to enter a name for the file to be saved to the MDA clipboard.

The program is saved/stored as a part program (MPF) under the name you have entered in the part programs directory.

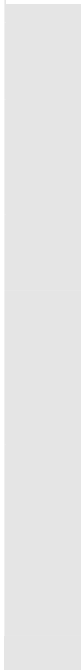

MDA file
function

Read in
MDA

Save
MDA progr.

4.5.3 Teach in

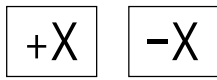

Function

With the "Teach-in" function, part programs (main programs and subprograms) for motion sequences or simple workpieces can be created, edited and executed by approaching and then storing positions in combination with the "MDA" function.

There are two possible methods of writing programs with "Teach-in" and "MDA":

1. Manual positioning
2. Manual input of coordinates and additional information

Both entry of blocks (input, delete, insert) and automatic insertion by manual approach of positions are possible only at points that have not yet been executed.

1. Manual positioning

Sequence of operations

"MDA" mode is selected in the "Machine" operating area.

Submode "Teach-in" is selected.

After selection of the function, the cursor is located in the first blank line of the "Teach-in program" window.

Turning machine:

Press the "Axis" keys.

Milling machine:

Select the axis to be traversed.

then press the "-" or "+" key.

The axis name and the path being traversed are displayed continuously on the screen in the "Teach-in program" window. The axis identifier and axis positions are transferred to the MDA program as values referred to the workpiece coordinate system.

Save position values:

Enter the additional functions (e.g. feedrates, auxiliary functions, etc.) in the program (if permitted).

Using MDA file functions, you can save the MDA program in the "Part programs" directory (MPF.DIR).

Using the edit functions of the vertical softkeys, you can execute the following program block functions: Overwrite, Select, Copy, Paste, Delete, Find, Find Next and Position.



When you switch to "MDA" mode and press "NC Start", the corresponding traversing motions and additional function entries are executed as program blocks. While the program is being processed, the blocks traversed by the NC are displayed in the "Current block" window.

2. Manual input of coordinates**Sequence of operations**

"MDA" mode is selected in the "Machine" operating area.

Save position values/additional functions:

Transfer the coordinates of the traversing positions plus any additional functions (preparatory functions, auxiliary functions, etc.) to the program by entering them in the "MDA program" window.

Additional information

- Any change to the work offset will cause the axis to carry out compensating movements when you press NC Start.
- In the case of G64, the end point response will differ when the part program is executed in "Automatic" mode.
- All the G functions can be used.
- When using special kinematics or robots, the positions of the STAT machine and rotary axis TU are displayed in addition to the positions in the workpiece coordinate system.

4.6 Automatic mode

4.6.1 Function and main screen



Function

You can execute part programs fully automatically in "Automatic" mode; this is the normal operating mode for part machining.

Preconditions

The following conditions must be fulfilled before you can execute part programs:

- You have already synchronized the control measuring system with the machine (i.e. "approached" reference points).
- You have already downloaded the associated part program to the control.
- You have checked or entered the necessary offset values, such as work offsets or tool offsets.
- The required safety interlocks are already active.

Position, federate, spindle and tool values as well as the workpiece program are displayed in the "automatic" main screen.

MKS	Position	Restweg	Masterspindel S1	
+ X1	42.822 mm	112.178	Ist 300.000 U/min	
Y1	90.000 mm	0.000	Soll 300.000 U/min	
Z1	-62.933 mm	0.000	Pos 0 grad	
A1	0.000 grd	0.000	Leistung 100.0 %	
+ SPI	97.015 grd	0.000		
Aktueller Satz MPF\WELLE1.MPF			Vorschub [mm/min]	
x0			Ist 810.000	90.0 %
x155			Soll 900.000	
y0			Werkzeug	
			vorangewähltes Werkzeug:	
			G01	G40

Explanation of main screen

The following windows are displayed:

Actual value window, spindle window, federate and tool window.

Program
overview

Horizontal softkeys

The workpiece or program overview is displayed. In this area, it is possible to select programs for execution.

The memory space available on the hard disk and in the NCU is displayed in the footer.

Program
blocks

Vertical softkeys

In addition, the window "program blocks" is displayed. The current block is highlighted while the program is running.

The name of the program to which the blocks on the screen belong is output in the window header.

Program
levels

The "program levels" window is displayed after pressing the softkey "program levels". The program nesting depth (P = number of passes) is displayed.

Program		MPFWELLE1.MPF
Program	P	
1 : WELLE1.MPF	1	
2 :	0	
3 :	0	
4 :	0	
5 :	0	

Program
execution

In program operation, it is possible to toggle between the window "Program levels" and "Program execution"

Program
blocks

9 program blocks of the current program are displayed together with the current position in the part program. In running operation, the 3-block display (softkey "program execution") and the multi-block display (softkey "program blocks") can be selected.

Additional information

The other softkeys are described in the sections below.

4.6.2 Program overview



Program
overview

Function

After selection of a workpiece or program overview, individual workpieces or programs can be enabled or disabled for execution.

Sequence of operations

"AUTO" mode is selected in the "Machine" operating area.
The appropriate channel is selected.
The channel is in reset state.
The workpiece/program to be selected is in the memory.

An overview of all workpiece directories/programs that exist is displayed.

Position the cursor on the desired workpiece/program.

Vertical softkeys

Select the workpiece/program for execution:

Selection

The name of the selected workpiece is displayed on the screen in the "Program name" field at the top. The program is also loaded and selected for processing.

Change
enable

The selected workpiece/program is enabled (X) or disabled (no "X").
A selection can only be made when the workpiece/program is enabled.

Explanation of other softkeys:

All existing programs of a particular type are displayed via the horizontal softkeys:

Work-
pieces

Display of all existing workpiece directories

Part
programs

Display of all existing part programs

Sub-
programs

Display of all existing subprograms

Standard
cycles

Display of all existing standard cycles

User cycles	Display of all existing user cycles
Manufact. cycles	Display of all existing manufacturer cycles

4.6.3 Loading and unloading the workpiece/part program



Function

Workpieces and part programs can be stored in the NC working memory ("Load") and erased from this memory again ("Unload") after they have been executed.

In this way, it is possible to prevent the NC working memory from becoming unnecessarily overloaded because programs that are no longer required can be erased immediately.



Sequence of operations

The "Machine" operating area is selected.

The "Program overview" opens.
The vertical softkey bar changes.

Position the cursor in the directory tree on the workpiece/part program that you wish to load.

Program overview

The selected workpiece/part program is loaded from the hard disk into the memory of the NC.

It is erased from the hard disk.

Load
HD->NC

If the enable command (X) is set, the workpiece can be machined.

Enable

The highlighted workpiece/part program is loaded from the NC memory to the hard disk.

The workpiece/program is erased from the NC memory.

Unload
NC->HD

If a program requires more memory than the NC can provide for execution, then it can be executed from the hard disk without loading it completely into the NC.

Execute fr.
hard disk



Additional information

Workpieces/part programs that have been loaded into the NC memory are marked with ("X") in the "Loaded" column in the workpiece/program overview.

4.6.4 Protocol: Program loading list



Function

Error list:
Display of previously loaded programs if errors have occurred during loading.



Sequence of operations

The "Machine" operating area is selected.

The "Program overview" opens.
The softkey bars change.
Press the "Log" softkey.
The "Job log for program overview" window is opened.

Program
overview



Log

4.6.5 Executing from the hard disk



Program
overview

Execute fr.
hard disk

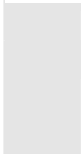

External
programs



Function

If a program requires more memory than the NC can provide for execution, then it can be loaded continuously from the hard disk.

Sequence of operations

The "Machine" operating area is selected.

The "Program overview" opens.

The vertical softkey bar changes. Select the program you wish to execute with the cursor (enable (x) must be set).

The highlighted program is loaded continuously to the NC working memory during execution.

Press "NC Start".

The program remains stored on the hard disk while the "Execute from hard disk" function is in progress.

The "External programs" window is opened.

The "Status" field indicates what percentage of the program has been loaded from the hard disk.

Additional information

Programs which are executed from the hard disk are marked with "EXT" in the program overview.

The identifier "EXT" does not disappear until a different part program is selected in this channel.

When executing from the hard disk and with EXTCALL, only the 3-block display (softkey "program execution") is possible.

This setting applies for the **single block** or **NC stop** status.

4.6.6 Accessing an external network drive



Function

With the SINDNC software, you can link your control to external network drives or other computers. This makes it possible, for example, to execute part programs from other computers.

Prerequisite:

- The SINDNC software is installed.
- The computer or drive which you want to link up to is accessible/enabled.
- A connection to the computer/drive has been established.
- The softkeys to select the drive/computer connection were configured using machine data
- Separate display machine data which define the access rights to external drives exist for the Machine and Program operating areas

See: Commissioning Manual HMI-Advanced (IM4)



Sequence of operations

You can access the softkeys (configured) for the external drive or computer in the Machine operating area via the "Program overview" softkey and the "ETC." key. Horizontal softkeys 1 to 4 are reserved for external execution. The vertical softkey bar changes.

When you press a softkey, e.g., "Drive F:" or "R4711" the Explorer appears on the screen with the data of the external drive, e.g. "Drive F" or of computer "R4711".

Select the program that you want to execute with the cursor and then press the "Execute from hard disk" softkey.

The program starts when you press "NC Start".

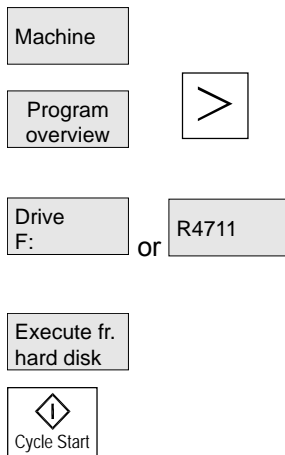



Softkey definitions

Press the "Program overview" softkey in the Machine (and Program) operating area to access the first three softkeys configured for external network drives. If you have configured four softkeys, the fourth one is displayed in the More bar when you press the "ETC" key. If no softkeys are configured for external drives, the "Standard cycles", "User cycles" and "Manufacturer cycles" softkeys can be found in the appropriate places in the horizontal softkey bar.

Program call from the part program: EXTCALL

It is possible to access files on network drives from a part program using the EXTCALL command.

The programmer can set the source directory in the part program in setting data

SD 42700: EXT_PROG_PATH, then specify the file name of the subprogram to be loaded in the EXTCALL command.



The following supplementary conditions must be taken into account with EXTCALL calls:

- With EXTCALL, you can only call files with the MPF or SPF extension from a network drive.
- DOS naming conventions must be used for the files and paths: Max. 25 characters for the name, 3 characters for the file extension.
- A program unit is found on a network drive with the EXTCALL command if
 - The search path in SD 42700: EXT_PROG_PATH points to the network drive or a directory contained on the network drive. The program must be stored directly on that level, no subdirectories are searched.
 - The correct location of the program is specified in the EXTCALL call itself by means of a fully qualified path that can also point to a subdirectory of the network drive.
 - The search path is not restricted by means of SD 42700: EXT_PROG_PATH.



References

For further information about the EXTCALL command, please refer to: /PGA/ Programming Guide Advanced, Chapter 2.
/FB/, K1 Description of functions "Execution from external source"

4.6.7 Program editing



Function

As soon as a syntax error in the part program is detected by the control, program execution is interrupted and the syntax error is displayed in the alarm line.

You can switch to the program editor and monitor the program execution in a full-screen display. If an error occurs (Stop state), you can edit the program in the program editor.



Sequence of operations

"AUTO" mode is selected in the "Machine" operating area.

It is not possible to overtravel the point of interruption. The feedrate override switch is active.

The program status is "Stopped" or "Reset".

Edit
program

When you press this softkey, the correction editor is displayed, the softkey bars change and the softkey "Edit" is highlighted.

If an error occurs, the faulty block is highlighted and can be corrected.

Using editor functions "Overwrite", "Highlight block", "Insert block", "Go To..." and "Find...", you can edit the program in the compensation block editor.

Program
level +

or

Program
level -

You can toggle between program levels using these softkeys.

Press "Level -" to view the program in which the faulty routine is called. You can return to the program to be edited by pressing "Level +". This is only possible if the NC has a compensation block.

Cycle Start

After you have corrected the error, you can continue the program run by pressing "NC Start".



- NC Stop status:
Only program lines that have not yet been executed can be edited.
- Reset status:
All program lines can be edited.

Note:

You cannot use the "Program editing" function if you are executing a program from the hard disk.

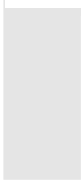

Additional information

If the error cannot be corrected in the "Channel aborted" state, an appropriate message is displayed when the "Compensation block" softkey is pressed.

In this case, program execution must be aborted with "NC Reset". The part program can then be edited under Programming.

4.6.8 Setting the block search/search target



Function

Block search offers the possibility of starting part program execution from almost any part program block. This involves the NC rapidly performing an internal run through the part program (without traversing motions) to the selected target block.

Here, every effort is made to achieve to the exact same control status as would result at the target block during normal part program execution (e.g., with respect to axis positions, spindle speeds, loaded tools, NC/PLC interface signals, variable values) in order to be able to resume automatic part program execution from the target block with minimum manual intervention.



Block search

The following versions are available:

1. **Without calculation on contour:**

No calculations are made during block search. The values stored in the control remain the same as they were before the block search.

2. **With calculation on contour:**

During block search with calculation, the same calculations are performed as in normal program control. The complete target block is then executed in the same way as with normal program execution.

3. **With calculation at block end point:**

During block search with calculation, the same calculations are performed as in normal program control. The interpolation mode valid in the target block is then applied to approach its end point or the next programmed position.

4. **Multi-channel block search with calculation**

This block search is called SERUPRO in "Program test" mode. Single-channel applications are supported for parallel interaction with other functions. No axis movements are executed during the block search; however, all auxiliary functions are output to the PLC during the block search.

The NC will start the selected program in Program test mode automatically. If the NC reaches the specified target block in the current channel, it stops at the beginning of the target block and deselects Program test mode again. The auxiliary functions up to the target block are not output. After continuing the program with NC start (after REPOS motion) the auxiliary functions of the target block are output.

The search target can be determined:

- Direct positioning
- By specifying a block number, a label, a program name or any character string



References

For further information about block search, please refer to:

/FB1/ Function Manual Basic Functions; K1:



Sequence of operations

"AUTO" mode is selected in the "Machine" operating area.

The channel is in reset status

The program in which the block search is to be performed is selected.

Block
search

Calls up the "block search" function.

Position the cursor on the target block.



Notes

- If the target block is found, this block becomes the current block. HMI announces "Search target found" and displays the target block in the current block display.
- Action blocks (e.g., collection of auxiliary functions) are output after the first NC Start.
- Alarm 10208 is output to indicate that operator interventions such as Overstore or Mode Change after JOG are permissible.
- After the second NC Start, the program is started and the process resumes at this target block.

Without
calculation

Block search start without calculation

Block search without calculation is used to find a part program block in the quickest possible way. No calculation of any type is performed. The control status at the target block remains unchanged compared to the status before the start of the block search.

Calculate
contour

Block search start with calculation on contour

Block search with calculation at contour is used to enable the programmed contour to be approached in any situation. On NC START, the start position of the target block or the end position of the block before the target block is approached. This is traversed up to the end position. Processing is true to contour.

Calc. block
end poin

Block search start with calculation at block end point

Block search with calculation at block end point is used to enable a target position (e.g., tool change position) to be approached in any situation. The end position of the target block or the next programmed position is approached using the type of interpolation valid in the target block. This is not true to contour. Only the axes programmed in the target block are moved.

Prog.test
contour

Start of search run with calculation in "Program test" (SERUPRO) mode

SERUPRO (**SEARCH RUN BY PROGRAMTEST**) is block search run with calculation across all channels (channel modal). Here, the NC starts the selected part program in "Program test" mode. On reaching the target block, the program test is automatically deselected. This type of block search also enables interactions between the channel in which the block search is being performed and synchronized actions as well as with other NC channels.

Generally, the following applies to all block search run types: If necessary, a collision-free initial situation must be created manually on the machine in "JOG REPOS" mode before the start of further automatic part program execution.

 Reset

Block search can be aborted with Reset.

Search
position

Define search target in program editor:

The currently selected program level is displayed.

Position the cursor bar on a target block of your choice in the part program.

Program
level +

or

Program
level -

You can toggle between program levels using these softkeys if necessary.

Search
pointer

Define search target in search pointer:

Once the "search pointer" softkey has been pressed, a screen with the program pointer is displayed.

This contains input fields for program name, search type (block number, text, ...) and search target (content). The cursor is positioned in the input field for the "search type".

0 **5**

...

You must enter your selected search type for the search target in the "Type" input field.

Information about the available search types is displayed in the user response line.

The following search types can be entered:

Search type (= jump to ...)	Value in search type field
End of program	0
Block number	1
Jump label	2
Any character string	3
Program name	4
Line number	5

Different search types can be specified for different program levels.

A Z
...

0 9
...

Interruption
point

You can enter your chosen search target (according to search type) in the "Search target" field.

You can enter the corresponding number of program passes in the "P" field (pass counter).

Preassign search target as last program interruption point:

The search pointer is assigned the data of the last program interruption point.

4.6.9 Accelerated external block search



Function

The block search function allows you to run the part program forward until you reach the block you require.

You can use the "External without calc." softkey in the "Search position" and "Search pointer" menus to start an accelerated block search in programs that are executed from an external device (local hard disk or network drive).

The search target can be determined:

- By directly positioning the cursor on the target block, or
- Specifying a block or line number

Block search sequence:

Only those programs and program parts which are needed in order to reach the specified search target and to continue program execution are transferred to the NC.

This applies to the following:

- "Execution from external source"
- Execution of EXTCALL instructions

Example:

The following search targets are entered in the Block search menu:

Search target 1 "Level1": MAIN1.MPF "Line": 8

Search target 2 "Level2": SUBPRG2.SPF "Line": 4000

Search target 3 "Level3": SUBPRG3.SPF "Line": 2300

Programs

```

MAIN1.MPF
1      G90
2      X100 Y200 F2000
3      EXTCALL "SUBPRG1"
4      X200 Y400
5      EXTCALL "SUBPRG2"
6      EXTCALL "SUBPRG3"
7      X0 Y0
Search target 1 8      EXTCALL "SUBPRG2"
9      X50
10     M30

SUBPRG2.SPF
1      X200 Y300
2      X400 Y500
3      EXTCALL "SUBPRG3"
.
.
Search target 2 4000 EXTCALL "SUBPRG3"
.
.
5000   M17

SUBPRG3.SPF
1      X20 Y50
2      .
.
Search target 3 2300 X100 Y450
.
.
5000   M17

```

A distinction is made between the following two cases for block search:

1. The main program MAIN1.MPF is in the NC, the subprograms SUBPRG1.SPF to SUBPRG3.SPF are executed from an external source.
2. The main program MAIN1.MPF and the subprograms SUBPRG1.SPF to SUBPRG3.SPF are executed from an external source.

Case 1

- Search target 1: The NC does not consider the EXTCALL calls in lines 3, 5, and 6 of the main program MAIN1.MPF and jumps to the search target Line 8.
- Search target 2: The NC jumps to the search target at line 4000 of external subprogram SUBPRG2.SPF; the previous statements in the external program are skipped.
- Search target 3: The NC jumps to the search target at line 2300 of external subprogram SUBPRG3.SPF; the previous statements are skipped, and the search stops.

On NC Start, the subprogram SUBPRG3.SPF is processed starting at the target line.

Case 2

- Search target 1: The NC jumps to line 8 of the search target.
- Search target 2: See above
- Search target 3: See above

On NC Start, the subprogram SUBPRG3.SPF is started and executed starting at the target line.

Sequence of operations

"AUTO" mode is selected in the "Machine" operating area.

The channel is in reset status

The program in which the block search is to be performed is selected.

Switches to the "Search position" dialog.

Define search target in program editor:

The currently selected program level is displayed.

The block search via "Search position" is only possible for programs which have been loaded onto the NC and not for programs executed from the hard disk.

Position the cursor bar on a target block of your choice in the part program.



Block
search

Search
position

Program
level +

or

Program
level -Ext. without
calc.Search
pointerExt. without
calc.

If an interruption point is available on the NC, you can switch back and forth between the program levels.

Start search without calculation for external programs.

Define search target in search pointer:

Once the "search pointer" softkey has been pressed, a screen form with the program pointer is displayed.

This contains input fields for program name, search type (block number, text, ...) and search target (content). The cursor is positioned in the input field for the "search type".

Type 1 (block number) and type 5 (line number) are possible as search target types.

Start search without calculation for external programs.

4.6.10 Block search in Program test mode, multi-channel



Function

The NC is operated in Program test mode for this block search, so that interactions between channel and synchronous actions and between multiple channels are possible within an NCU.

The "Block search in Program test mode" enables a program advance up to the desired point of the part program with the following functions: During "Block search in Program test mode", the NC outputs all auxiliary functions to the PLC and the part program commands for channel coordination (WAITE, WAITM, WAITMC, Axis replacement, Write variables, etc.) are carried out by the NC.

- This means that the PLC is updated during this block search and
- Machining operations involving multiple channels are executed correctly within the block search.

You can select the function via the "Prog. test Contour" softkey in the "Search position" and "Search pointer" menus.

You can define the search target by

- Directly positioning the cursor on the target block, or
- Using the input fields "Program name", "Search type" and "Search target".



Block search

Search position

Program level + or Program level -

Prog.test contour

Search pointer

Prog.test contour

Sequence of operations

Prerequisite:

- "AUTO" is selected as operating mode.
- All channels are in the Reset state.
- The program in which the block search is to be performed is selected.

The channel in which the target block is searched for or the program pointer set is the target channel. Other channels are started according to the setting in the "machine.ini" file.

Switches to the "Search position" dialog.

Define search target in program editor:

The currently selected program level is displayed.

Position the cursor bar on a target block of your choice in the part program.

You can toggle between program levels using these softkeys if necessary.

Start of search in Program test mode.

A dialog message appears as soon as all the channels involved in the current search have exited Program test mode. This message indicates that Repos offsets may, depending on the particular part program, have been produced in the channels involved during the block search and will be retracted by the NC through interpolation the next time it starts. You must acknowledge this message.

The repositioning offsets that occur may be traversed manually in JOG mode before continuing program processing with the "NC Start" key at the program position reached in the block search.

Define search target in search pointer:

Once the "search pointer" softkey has been pressed, a screen with the program pointer is displayed.

This contains input fields for program name, search type (block number, text, ...) and search target (content). The cursor is positioned in the input field for the "search type".

Start of search in Program test mode.

A dialog message appears as soon as all the channels involved in the current search have exited Program test mode, see "Search target in program editor mode" above.

Any repositioning offsets (in the individual channels) can be retracted in sequence via manually controlled traversing movements in JOG mode, before program processing is continued via NC Start at the point in the program reached by the block search.

4.6.11 Overstore



Function

In "AUTO" mode, you can overstore technological parameters (auxiliary functions, all programmable instructions ...) in the working memory of the NC. You can also enter and execute any NC block.



Sequence of operations

"AUTO" mode is selected in the "Machine" operating area.

Overstore with single block:

The program automatically stops at the next block boundary.

The "Overstore" window is opened.

In this window, you can now enter the NC blocks that are to be executed.

The blocks you have entered are executed and displayed in the "Current block" window.

The "Overstore" window and associated softkeys are not displayed again until the control switches to the "Channel interrupted", "NC Stop" or "NC Reset" state.

More blocks can be added to the overstore buffer when these blocks have been executed.

Note:

After "Overstore", a subprogram with the content REPOSA is executed. The program is displayed for the user.



Overstore





Overstore without single block:

The main menu for "AUTO" mode is selected.

Stop the program by pressing "NC Stop".

The "Overstore" window is opened.

In this window, you can now enter the NC blocks that are to be executed.

The blocks you have entered are executed, the "Current block" window is opened and the softkeys disappear. The "Overstore" window and associated softkeys are not displayed again until the control switches to the "Channel interrupted", "NC Stop" or "NC Reset" state.

More blocks can be added (to the overstore buffer) when these blocks have been executed.

Additional information

- You can close the window and exit the Overstore function by pressing the "Recall" key. You have now exited the Overstore function.
- You cannot change operating modes until you have deselected "Overstore" with the "Recall" key.
- The program that was selected before Overstore is now resumed in "AUTO" mode when you press "NC Start" again.
- Overstore does not alter the programs stored in the part program memory.

4.6.12 Program control



Function

You can use this function to change a program sequence in "AUTO" and "MDA" modes. The following program control functions can be activated or deactivated:

DRY Dry run feedrate
ROV Rapid traverse override
M01 Programmed stop 1
MFct* Programmed stop 2

DRF DRF selection
PRT Program test

SBL1 Single block with STOP after each machine function
SBL2 Single block with STOP after each block
SBL3 Stop in cycle
MFct* The M function defined in the machine data is displayed.

- "Skip blocks" softkey: You can activate up to 10 skip levels in respect of SKP skip blocks. See machine manufacturer's specifications.
- "Block display" softkey: Block display modes during program execution: Either all blocks are displayed or only motion blocks.

The display is dependent on the machine data of the operator panel front in which access authorization can be set.

References

For further information, please refer to Section 2.5, under "Program control display"

/FB/, A2, Various interface signals, Chapter 4, or
/FB/ K1, BAG, Channel, Program control

DRY

Program control with DRY

When you select the DRY function "dry run feedrate" in "Automatic" mode, the feedrate entered in setting data SD 42100:

DRY_RUN_FEED is applied in the program instead of the programmed feedrate.

SKP: Activate skip levels

It is possible to skip blocks, which are not to be executed every time the program runs (10 skip levels).

Blocks to be skipped are indicated in the part program by an oblique "/" before the block number. The skip levels in the part program are specified by "/0" or by "/" to "/9". You can activate/deactivate skip levels in the following window:

Program control	
SKP: Skip blocks	active
<input checked="" type="checkbox"/> <input checked="" type="checkbox"/> Skip /	<input checked="" type="checkbox"/> <input checked="" type="checkbox"/>
<input checked="" type="checkbox"/> Skip /1	<input checked="" type="checkbox"/>
<input checked="" type="checkbox"/> Skip /2	<input checked="" type="checkbox"/>
<input checked="" type="checkbox"/> Skip /2	<input type="checkbox"/>
<input checked="" type="checkbox"/> Skip /3	<input type="checkbox"/>
<input checked="" type="checkbox"/> Skip /4	<input type="checkbox"/>
<input checked="" type="checkbox"/> Skip /5	<input type="checkbox"/>
<input checked="" type="checkbox"/> Skip /6	<input type="checkbox"/>
<input checked="" type="checkbox"/> Skip /7	<input type="checkbox"/>
<input checked="" type="checkbox"/> Skip /8	<input type="checkbox"/>
<input checked="" type="checkbox"/> Skip /9	<input type="checkbox"/>

This program control window is displayed only if more than 1 skip level was set via machine data. Only the set skip levels are displayed. Changes to machine data are described in Section 9.1.

Display activated skip levels

If more than one skip level is active, the right column indicates whether the PLC has transmitted the skip level selection to the NC.

This allows you to see from the top window which level

- is selected, but not yet active
- selected and active
- deselected and active
- deselected and not active.



Sequence of operations

"AUTO" or "MDA" mode is selected in the "Machine" operating area.

Press the "Program control" horizontal softkey.

Program
control

Another window pane, "Program control", appears on the main screen. The softkey bars change and the softkeys of the skip blocks and block display appear in the vertical menu.



Each actuation of the "toggle key" activates or deactivates the selected program control function.

Skip blocks

The block display appears in an extended "program control" window pane and can be selected with the "Block display" vertical softkey.

Skip
blocks

Press the "Skip blocks" vertical softkey.



The "Skip blocks" vertical softkey is only displayed if more than 1 skip level was set in MD 9423: MA_MAX_SKP_LEVEL. The levels to be skipped can only be changed when the control is in the Stop/Reset state.

Place the cursor at the required position.



Each press of the "Toggle key" activates or deactivates the selected skip level in the "Program control" window.



Additional information

The entries influence the program control display (see Section 2.5). The program control display is output irrespective of the selected menu.



References

For further information about how to program skip levels, please see: /PG/, Programming Guide Fundamentals

Block display during program execution

Block display

Block display during program execution appears in an extended "Program control" window pane and can be selected with the "Block display" vertical softkey.

Press the "Block display" vertical softkey.

Program execution modes

A separate "program control" window pane with the previous block display appears on the main screen. You can select the following while the program is running:

Block display during program execution

- Display all blocks
- Display traversing blocks only

Current block

The last current block is shown in the block display. If you want to display all current blocks, you can use the selection menu to choose the desired block.

**M Fct***

When this function is active, program execution on the NC is interrupted on request by the PLC at blocks in which the additional *associated M function* is programmed for a conditional stop 2.

The M Fct* number displayed here can be changed to the desired value in the Commissioning operating area under Machine Data/Channel MD by selecting the machine data corresponding to the M function. The number stored in this machine data is then displayed. The value of this auxiliary M function number must match the programmed stop 2.

Additional information

Blocks which are too long for the display window (approx. 65 characters) are truncated and the truncated code is replaced by "...".

4.6.13 DRF offset

**Switch-on/switch-off****Function**

DRF is an axial technique that acts in the basis coordinate system. It is only permissible to select the handwheel via the axial interface – i.e. only machine axis names may be used.

The DRF offset can be switched on and off for specific channels by means of the "Program control" function.

It remains stored until

- Power ON is performed for all axes
- DRFOF (selection of DRF via part program)
- PRESETON (modification of the actual value through Preset)

Alter DRF

You can alter the DRF offset by traversing the appropriate machine axis using the handwheel (the actual value display does not change).

**Sequence of operations**

"AUTO" mode is selected in the "Machine" operating area. The standard axis assignment is defined.

Enter the desired handwheel or select via the MCP.

Enter the desired increment or select via the MCP.

The "DRF offset" window is displayed.

Traverse the required axes using the handwheel.

Using the same operating sequence, you can also return the DRF offset to the value "0".

Handwheel

INC

or

[VAR]

DRF
Offset

Parameters operating area

5.1	Tool data	5-159
5.1.1	Tool offset structure	5-159
5.1.2	Tool types and tool parameters	5-159
5.2	Tool offset	5-174
5.2.1	Function and main screen Tool offset.....	5-174
5.2.2	New tool	5-176
5.2.3	Display tool.....	5-177
5.2.4	Deleting a tool	5-178
5.2.5	New cutting edge	5-179
5.2.6	Deleting a cutting edge	5-180
5.2.7	Determining a tool offset	5-180
5.2.8	Make tool offset immediately effective	5-181
5.3	Tool management	5-182
5.3.1	Main tool management functions	5-183
5.3.2	Displaying/editing tool data	5-190
5.3.3	Change in the significance/representation of tool wear values	5-194
5.3.4	Grinding data expansion	5-197
5.3.5	Load	5-199
5.3.6	Unload	5-203
5.3.7	Relocating	5-205
5.3.8	Tool master data in the tool catalog.....	5-206
5.3.9	Tool offset data in the tool cabinet.....	5-209
5.3.10	Job processing of tools	5-211
5.4	R parameters (calculation parameters)	5-221
5.5	Setting data	5-222
5.5.1	Working area limitation	5-222
5.5.2	JOG data	5-223
5.5.3	Spindle data	5-224
5.5.4	Dry run feedrate for dry run operation DRY	5-225
5.5.5	Starting angle for thread cutting.....	5-226
5.5.6	Miscellaneous setting data.....	5-227
5.5.7	Protection zones	5-228
5.5.8	Electronic gear	5-229
5.6	Zero/work offset	5-230
5.6.1	Function	5-230
5.6.2	Edit the settable work offset (G54 ...)	5-232
5.6.3	Global zero offset/frame.....	5-232
5.6.4	Displaying an active settable work offset.....	5-235
5.6.5	Displaying an active programmable work offset	5-236
5.6.6	Displaying an active external work offset.....	5-237
5.6.7	Display the sum of the active work offsets.....	5-237
5.6.8	Activate active work offset and basic frame immediately	5-238
5.6.9	Actual value display: Settable zero system, SZS	5-238

5.7	Define user data	5-239
5.7.1	Define variables (GUD, PUD, LUD)	5-239
5.7.2	Editing/finding user data	5-240
5.7.3	Activate user data (GUD)	5-242
5.8	Display system variables	5-244
5.8.1	Creating variable views	5-245
5.8.2	Managing variable views	5-247
5.8.3	Logging system variables	5-248

5.1 Tool data

5.1.1 Tool offset structure

	<p>A tool is selected in the program with the T function. Numbers T0 to T32000 can be assigned to tools. Each tool can have up to 9 cutting edges: D1-D9. D1 to D9 activates the tool offset of a cutting edge for the active tool.</p> <p>The tool length compensation is applied with the first traversing motion (linear or polynomial interpolation) of the axis.</p> <p>A tool radius compensation is activated by programming of G41/42 in the active plane (G17, 18, 19) and in a program block with G0 or G1.</p>
Tool wear	<p>Allowances for changes in the active tool shape can be made in the tool length (tool parameters 12-14) and tool radius (tool parameters 15-20).</p>
Tool offset with flat D numbers	<p>The so-called "flat D numbers" can be activated by means of NC machine data. This means that tool management is no longer available.</p> <p>The D number range increases to 1 - 32000. A D number can be assigned only once for each tool, i.e., each D number represents precisely one tool offset data record.</p>

5.1.2 Tool types and tool parameters

Entries	<p>T No. Tool number</p> <p>D No. Cutting edge number</p> <p>Every data field (offset memory) that can be called with a D number contains not only the geometric information for the tool but also further entries, i.e., the tool type (drill, milling cutter, turning tools with cutting edge position, etc.).</p>
----------------	--

Tool types

Tool type classification:

• **Group type 1xx (milling cutters):**

- 100 Milling cutter to CLDATA
- 110 Ball-end cylindrical die-sinking cutter
- 111 Ball-end tapered die-sinking cutter
- 120 End mill (without corner rounding)
- 121 End mill (with corner rounding)
- 130 Angle head cutter (without corner rounding)
- 131 Angle head cutter (with corner rounding)
- 140 Facing tool
- 145 Thread cutter
- 150 Side mill
- 151 Saw
- 155 Bevel cutter
- 156 Bevel cutter with rounding
- 157 Tapered die-sinking cutter
- 160 Drill and thread milling cutter

**Required offset values
for a milling cutter**

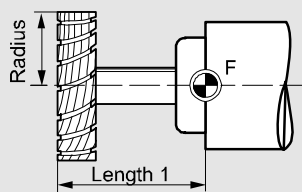
Entries in tool parameters										
DP1	1xy									
DP3	Length 1									
DP6	Radius									
Wear values according to requirement		<table border="1"> <thead> <tr> <th colspan="2">Effect</th> </tr> </thead> <tbody> <tr> <td>G17:</td> <td>Length 1 in Z Radius in X/Y</td> </tr> <tr> <td>G18:</td> <td>Length 1 in Y Radius in Z/X</td> </tr> <tr> <td>G19:</td> <td>Length1 in X Radius in Y/Z</td> </tr> </tbody> </table>	Effect		G17:	Length 1 in Z Radius in X/Y	G18:	Length 1 in Y Radius in Z/X	G19:	Length1 in X Radius in Y/Z
Effect										
G17:	Length 1 in Z Radius in X/Y									
G18:	Length 1 in Y Radius in Z/X									
G19:	Length1 in X Radius in Y/Z									
Other values must be set to zero		F - Toolholder reference point								

Milling cutter with adapter

Entries in tool parameters										
DP1	1xy									
DP3	Length 1 _{_Geometry}									
DP6	Radius _{_Geometry}									
DP21	Length _{_Adapter}									
Wear values according to requirement		<table border="1"> <thead> <tr> <th colspan="2">Effect</th> </tr> </thead> <tbody> <tr> <td>G17:</td> <td>Length 1 in Z Radius in X/Y</td> </tr> <tr> <td>G18:</td> <td>Length 1 in Y Radius in Z/X</td> </tr> <tr> <td>G19:</td> <td>Length 1 in X Radius in Y/Z</td> </tr> </tbody> </table>	Effect		G17:	Length 1 in Z Radius in X/Y	G18:	Length 1 in Y Radius in Z/X	G19:	Length 1 in X Radius in Y/Z
Effect										
G17:	Length 1 in Z Radius in X/Y									
G18:	Length 1 in Y Radius in Z/X									
G19:	Length 1 in X Radius in Y/Z									
Other values must be set to zero		F'- Toolholder reference point								

- **Group type 2xx (drills):**

- 200 Twist drill
- 205 Drill
- 210 Boring bar
- 220 Center drill
- 230 Countersink
- 231 Counterbore
- 240 Tap regular thread
- 241 Tap fine thread
- 242 Tap Whitworth thread
- 250 Reamer

Required offset values for a drill

Entries in tool parameters										
DP1	2xy									
DP3	Length 1									
Wear values according to requirement		<table border="1"> <thead> <tr> <th colspan="2">Effect</th> </tr> </thead> <tbody> <tr> <td>G17:</td> <td>Length 1 in Z</td> </tr> <tr> <td>G18:</td> <td>Length 1 in Y</td> </tr> <tr> <td>G19:</td> <td>Length 1 in X</td> </tr> </tbody> </table>	Effect		G17:	Length 1 in Z	G18:	Length 1 in Y	G19:	Length 1 in X
Effect										
G17:	Length 1 in Z									
G18:	Length 1 in Y									
G19:	Length 1 in X									
Other values must be set to zero		F - Toolholder reference point								

- Group type 4xx (grinding tools):
 - 400 Surface grinding wheel
 - 401 Surface grinding wheel with monitoring
 - 402 Surface grinding wheel without monitoring
 - 403 Surface grinding wheel with monitoring without tool base dimension for grinding wheel peripheral speed GWPS
 - 410 Facing wheel
 - 411 Facing wheel with monitoring
 - 412 Facing wheel without monitoring
 - 413 Facing wheel with monitoring without tool base dimension for grinding wheel peripheral speed (GWPS)
 - 490 Dresser

Offset values required by a surface grinding wheel

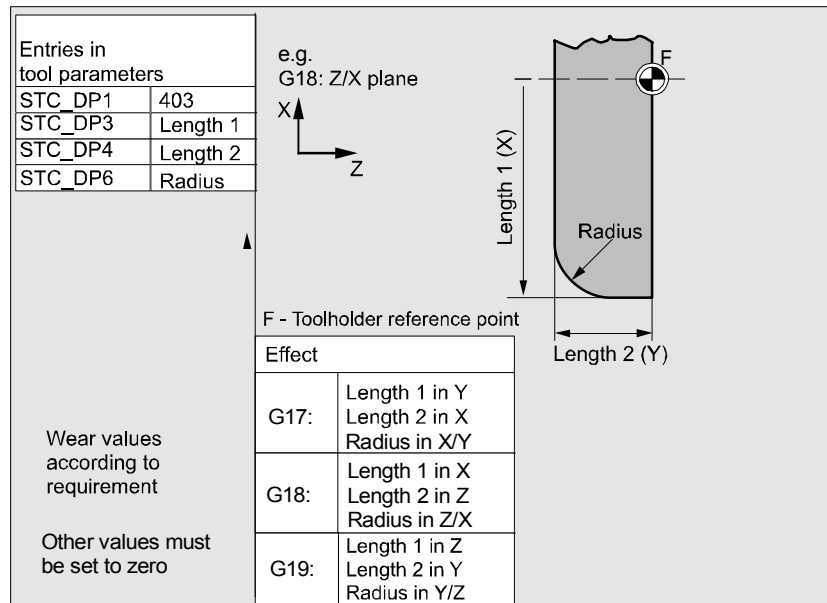

Required offset values for inclined grinding wheel with implicit monitoring selection

Entries in tool parameters		STC_TPG1	Spindle number
		STC_TPG2	Chaining rule
STC_DP1	403	STC_TPG3	Minimum wheel radius
STC_DP3	Length 1	STC_TPG4	Minimum wheel width
STC_DP4	Length 2	STC_TPG5	Current wheel width
STC_DP6	Radius	STC_TPG6	Maximum speed
Wear values according to requirement		STC_TPG7	Max. surface speed
		STC_TPG8	Angle of the inclined wheel
		STC_TPG9	Parameter no. for radius calculation
Other values must be set to zero		F: Toolholder reference point	
Effect			
G17:	Length 1 in Y Length 2 in X Radius in X/Y		
G18:	Length 1 in X Length 2 in Z Radius in Z/X		
G19:	Length 1 in Z Length 2 in Y Radius in Y/Z		

Required offset values for inclined grinding wheel with implicit monitoring selection

Entries in tool parameters		STC_TPG1	Spindle number
		STC_TPG2	Chaining rule
STC_DP1	403	STC_TPG3	Minimum wheel radius
STC_DP3	Length 1	STC_TPG4	Minimum wheel width
STC_DP4	Length 2	STC_TPG5	Current wheel width
STC_DP6	Radius	STC_TPG6	Maximum speed
Wear values according to requirement		STC_TPG7	Max. surface speed
		STC_TPG8	Angle of the inclined wheel
		STC_TPG9	Parameter no. for radius calculation
Other values must be set to zero		F: Toolholder reference point	
Effect			
G17:	Length 1 in Y Length 2 in X Radius in X/Y		
G18:	Length 1 in X Length 2 in Z Radius in Z/X		
G19:	Length 1 in Z Length 2 in Y Radius in Y/Z		

Required offset values of a surface grinding wheel without base dimension for GWPS

Entries in tool parameters		STC_TPG1	Spindle number
		STC_TPG2	Chaining rule
STC_DP1	403	STC_TPG3	Minimum wheel radius
STC_DP3	Length 1	STC_TPG4	Minimum wheel width
STC_DP4	Length 2	STC_TPG5	Current wheel width
STC_DP6	Radius	STC_TPG6	Maximum speed
STC_DP21	L1 base	STC_TPG7	Max. surface speed
STC_DP22	L2 base	STC_TPG8	Angle of the inclined wheel
Wear values according to requirement		STC_TPG9	Parameter no. for radius calculation
Other values must be set to zero		<p>F: Toolholder reference point</p>	
Effect			
G17:	Length 1 in Y Length 2 in X Radius in X/Y		
G18:	Length 1 in X Length 2 in Z Radius in Z/X		
G19:	Length 1 in Z Length 2 in Y Radius in Y/Z		

Required offset values of a facing wheel with monitoring parameters

Entries in tool parameters		STC_TPG1	Spindle number
		STC_TPG2	Chaining rule
STC_DP1	403	STC_TPG3	Minimum wheel radius
STC_DP3	Length 1	STC_TPG4	Minimum wheel width
STC_DP4	Length 2	STC_TPG5	Current wheel width
STC_DP6	Radius	STC_TPG6	Maximum speed
Wear values according to requirement		STC_TPG7	Max. surface speed
Other values must be set to zero		STC_TPG8	Angle of the inclined wheel
		STC_TPG9	Parameter no. for radius calculation
Effect		<p>F: Toolholder reference point</p> <p>e.g. G18: Z/X plane</p>	
Effect			
G17:	Length 1 in Y Length 2 in X Radius in X/Y		
G18:	Length 1 in X Length 2 in Z Radius in Z/X		
G19:	Length 1 in Z Length 2 in Y Radius in Y/Z		

Assigning the tool-specific parameters

Parameters	Significance	Data Type
Tool-specific parameters		
\$TC_TPG1	Spindle number	Integer
\$TC_TPG2	Chaining rule	Integer
\$TC_TPG3	Minimum wheel radius	Real
\$TC_TPG4	Minimum wheel width	Real
\$TC_TPG5	Current wheel width	Real
\$TC_TPG6	Maximum speed	Real
\$TC_TPG7	Maximum peripheral speed	Real
\$TC_TPG8	Angle of the inclined wheel	Real
\$TC_TPG9	Parameter number for radius calculation	Integer
Additional parameters		
\$TC_TPC1	Angle of the inclined wheel	Real
to		
\$TC_TPC10		Real

- Group type 5xx (turning tools):
 - 500 Roughing tool
 - 510 Finishing tool
 - 520 Plunge cutter
 - 530 Parting tool
 - 540 Threading tool
 - 550 Steel profile
 - 560 Rotary drill (ECOCUT)
 - 580 Oriented probe

Required offset values for a turning tool with tool radius compensation

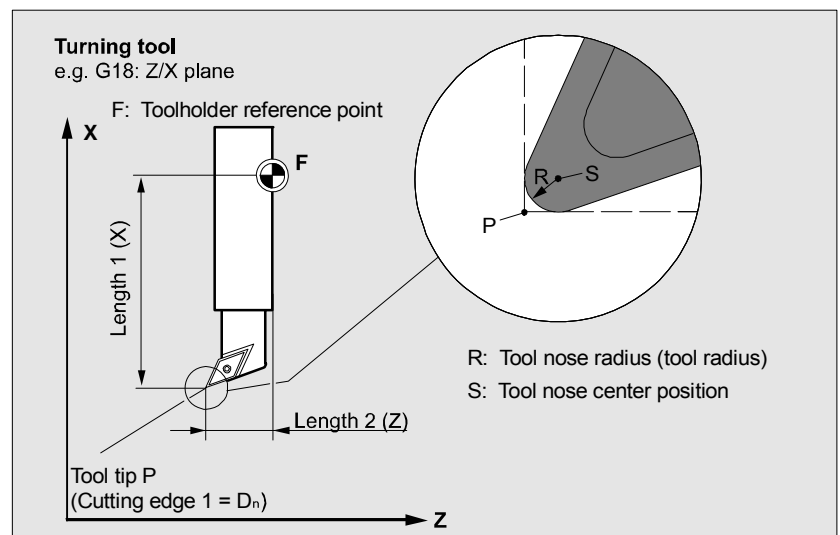

Required offset values for a turning tool with tool radius compensation

Tool parameter DP2 defines the tool nose position.
Any value between 1 and 9 can be entered.

X Tool nose position DP2

Note:
Length 1, length 2 refer to point P for edge
positions 1–8;
but in case of 9 to S (S = P)

Entries in tool parameters	
DP1	5xy
DP2	1...9
DP3	Length 1
DP4	Length 2
DP6	Radius

Wear values
according to
requirement

Other values must
be set to zero

Effect	
G17:	Length 1 in Y Length 2 in X
G18:	Length 1 in X Length 2 in Z
G19:	Length 1 in Z Length 2 in Y

- **Group type 7xx (special tools):**

- 700 Slotting saw
- 710 3D probe
- 711 Edge probe
- 730 Stop

Required offset values for slotting saw

- **Type 700 (slotting saw)**

Entries in tool parameters DP3 Length 1 - Base DP4 Length 2 - Base DP6 Diameter - Geometry DP7 Zero width - Geometry DP8 Projection - Geometry		
Wear values according to requirement Other values must be set to zero $L1 = DP3 + DP6/2$ $L2 = DP4 + DP7/2 - DP8$ $R = DP7/2$		
		Effect
G17:	Semi-diameter (L1) in Z Projection in (L2) Y Saw blade in (R) X/Y	Plane selection 1st-2nd axis (X-Y)
G18:	Semi-diameter (L1) in Y Projection in (L2) X Saw blade in (R) Z/X	Plane selection 1st-3rd axis (X-Z)
G19:	Semi-diameter (L1) in Z Projection in (L2) Z Saw blade in (R) Y/Z	Plane selection 2nd-3rd axis (Y-Z)

The offset data (TOA data) you can enter for tool type 700 "slotting saw" are as follows:

	Geometry	Wear	Base	
Length compensation				
Length 1	\$TC_DP3	\$TC_DP12	\$TC_DP21	mm
Length 2	\$TC_DP4	\$TC_DP13	\$TC_DP22	mm
Length 3	\$TC_DP5	\$TC_DP14	\$TC_DP23	mm
Radius compensation				
Diameter	\$TC_DP6	\$TC_DP15		mm
Slot width b	\$TC_DP7	\$TC_DP16		mm
Projection k	\$TC_DP8	\$TC_DP17		mm

3D probe

Stop

Type 710

See /BNM/, User Manual, Measuring cycles

Type 730

The stop is used to position the material in turning machines with bar feed. Only tool length compensation is important.

Calculation of tool parameters

Types 1xx (milling cutters), 2xx (drills) and 5xx (turning tools) are calculated according to the same scheme.

Several entries exist for the geometric variables (e.g., length 1 or radius). These are added together to produce a value (e.g., total length 1, total radius), which is then used for the calculations.

Tool parameter number (P)	Significance	Comment
1	Tool type	For overview see list
2	Length of cutting edge	only for turning tools
Geometry		Length compensation
3	Length 1	Calculation according to type and plane
4	Length 2	
5	Length 3	
Geometry		Radius
6	Radius	Does not apply to drills
7	Reserved	
8	Reserved	
9	Reserved	
10	Reserved	
11	Reserved	
Wear		Length and radius compensation Radius compensation
12	Length 1	
13	Length 2	
14	Length 3	
15	Radius	
16	Reserved	
17	Reserved	
18	Reserved	
19	Reserved	
20	Reserved	

Tool base dimension/ Length compensations adapter		
21	Length 1	
22	Length 2	
23	Length 3	
Technology		
24	Clearance angle	For turning tools
25	Clearance angle	

Offsets that are not required must be assigned the value 0 (= default when the offset memory is set up).

The individual values of the offset memory (P1 to P25) can be read and written by the program via system variables.

The tool offsets can be entered not only via the operator panel front but also via the data input interface.

Calculation of tool base dimensions for two-dimensional millhead

Entries in tool parameters		
DP1	5xy	
DP3	Length 1 - Geometry	
DP6	Radius - Geometry	
DP21	Length 1 - Base	
DP22	Length 2 - Base	
DP23	Length 3 - Base	
Wear values according to requirement Other values must be set to zero	Effect	
	G17:	Length 1 in Z Length 2 in Y Length 3 in X Radius in Y/Z
	G18:	Length1 in Y Length 2 in X Length 3 in Z Radius in X/Y
	G19:	Length 1 in X Length 2 in Z Length 3 in Y Radius in Z/X

Calculation of tool base dimensions for three-dimensional millhead:

Entries in tool parameters											
DP1	5xy										
DP3	Length 1- Geometry										
DP6	Radius - Geometry										
DP21	Length 1 - base										
DP22	Length 2 - base										
DP23	Length 3 - base										
Wear values according to requirement		Effect									
Other values must be set to zero		<table border="1"> <tr> <td>G17:</td> <td>Length 1 in Z Length 2 in Y Length 3 in X Radius in Y/Z</td> <td></td> </tr> <tr> <td>G18:</td> <td>Length 1 in Y Length 2 in X Length 3 in Z Radius in X/Y</td> <td></td> </tr> <tr> <td>G19:</td> <td>Length 1 in X Length 2 in Z Length 3 in Y Radius in Z/X</td> <td></td> </tr> </table>	G17:	Length 1 in Z Length 2 in Y Length 3 in X Radius in Y/Z		G18:	Length 1 in Y Length 2 in X Length 3 in Z Radius in X/Y		G19:	Length 1 in X Length 2 in Z Length 3 in Y Radius in Z/X	
G17:	Length 1 in Z Length 2 in Y Length 3 in X Radius in Y/Z										
G18:	Length 1 in Y Length 2 in X Length 3 in Z Radius in X/Y										
G19:	Length 1 in X Length 2 in Z Length 3 in Y Radius in Z/X										

Required length compensation values for turning tools:

Entries in tool parameters									
DP1	5xy								
DP3	Length 1								
DP4	Length 2								
Wear values according to requirement		Effect							
Other values must be set to zero		<table border="1"> <tr> <td>G17:</td> <td>Length 1 in Y Length 2 in X</td> <td rowspan="3">F: Toolholder reference point</td> </tr> <tr> <td>G18:</td> <td>Length 1 in X Length 2 in Z</td> </tr> <tr> <td>G19:</td> <td>Length 1 in Z Length 2 in Y</td> </tr> </table>	G17:	Length 1 in Y Length 2 in X	F: Toolholder reference point	G18:	Length 1 in X Length 2 in Z	G19:	Length 1 in Z Length 2 in Y
G17:	Length 1 in Y Length 2 in X	F: Toolholder reference point							
G18:	Length 1 in X Length 2 in Z								
G19:	Length 1 in Z Length 2 in Y								

Turning tool with several cutting edges - length compensation:

Entries in tool parameters		<p>Grooving tool e.g. G18: Z/X plane</p>								
DP1	5xy									
DP3	Length 1									
DP4	Length 2									
DP1	5xy									
DP3	Length 1									
DP4	Length 2									
Wear values according to requirement		<table border="1"> <tr> <th colspan="2">Effect</th> </tr> <tr> <td>G17:</td> <td>Length 1 in Y Length 2 in X</td> </tr> <tr> <td>G18:</td> <td>Length 1 in X Length 2 in Z</td> </tr> <tr> <td>G19:</td> <td>Length 1 in Z Length 2 in Y</td> </tr> </table>	Effect		G17:	Length 1 in Y Length 2 in X	G18:	Length 1 in X Length 2 in Z	G19:	Length 1 in Z Length 2 in Y
Effect										
G17:	Length 1 in Y Length 2 in X									
G18:	Length 1 in X Length 2 in Z									
G19:	Length 1 in Z Length 2 in Y									
Other values must be set to zero		<p>F: Toolholder reference point</p>								

Calculation of tool base dimensions for turning machine:

Entries in tool parameters		<p>Turning tool e.g. G18 Z/X plane</p>								
DP1	5xy									
DP3	Length 1 - Geometry									
DP4	Length 2 - Geometry									
DP21	Length 1 - Base									
DP22	Length 2 - Base									
Wear values according to requirement		<table border="1"> <tr> <th colspan="2">Effect</th> </tr> <tr> <td>G17:</td> <td>Length 1 in Y Length 2 in X</td> </tr> <tr> <td>G18:</td> <td>Length 1 in X Length 2 in Z</td> </tr> <tr> <td>G19:</td> <td>Length 1 in Z Length 2 in Y</td> </tr> </table>	Effect		G17:	Length 1 in Y Length 2 in X	G18:	Length 1 in X Length 2 in Z	G19:	Length 1 in Z Length 2 in Y
Effect										
G17:	Length 1 in Y Length 2 in X									
G18:	Length 1 in X Length 2 in Z									
G19:	Length 1 in Z Length 2 in Y									
Other values must be set to zero		<p>F': Tool base reference point F: Toolholder reference point</p>								

Tool type 4xx (grinding tools) is calculated separately.

Several entries exist for the geometric variables (e.g., length or radius).

Parameters	Grinding wheel-comp. left	Grinding wheel comp. right	Dresser left	Dresser right
Tool-specific parameters				
\$TC_DP1	Tool type	$*(2^0=1)$	Tool type	Tool type
\$TC_DP2	Length of cutting edge	Length of cutting edge	Length of cutting edge	Length of cutting edge
Geometry tool length compensation				
\$TC_DP3	Length 1	$*(2^2=4)$	Length 1	Length 1
\$TC_DP4	Length 2	$*(2^3=8)$	Length 2	Length 2
\$TC_DP5	Length 3	$*(2^4=16)$	Length 3	Length 3
\$TC_DP6	Radius	Radius	Radius	Radius
\$TC_DP7 to \$TC_DP11	Reserved	Reserved	Reserved	Reserved
Wear tool length compensation				
\$TC_DP12	Length 1	$*(2^{11}=2048)$	Length 1	Length 1
\$TC_DP13	Length 2	$*(2^{12}=4096)$	Length 2	Length 2
\$TC_DP14	Length 3	$*(2^{13}=8192)$	Length 3	Length 3
\$TC_DP15	Radius	Radius	Radius	Radius
\$TC_DP16 to \$TC_DP20	Reserved	Reserved	Reserved	Reserved
Base dimension/adapter dimension tool length compensation				
\$TC_DP21	Basic length 1	$*(2^{20}=1048576)$	Basic length 1	Basic length 1
\$TC_DP22	Basic length 2	$*(2^{21}=2097152)$	Basic length 2	Basic length 2
\$TC_DP23	Basic length 3	$*(2^{22}=4194304)$	Basic length 3	Basic length 3

Technology				
\$TC_DP24	Reserved	Reserved	Reserved	Reserved
\$TC_DP25	Reserved	Reserved	Reserved	Reserved
Additional parameters				
\$TC_DPC1				
to				
\$TC_DPC10				

* Value of the chaining parameter if the compensation parameters is to be chained.

Parameter number for radius calculation \$TC_TPG9

With this parameter it is possible to define which offset value is used for grinding wheel peripheral speed, tool monitoring and centerless grinding. The value always refers to cutting edge D1.

\$TC_TPG9 = 3	Length 1 (geometry + wear + base, depending on tool type)
\$TC_TPG9 = 4	Length 2 (geometry + wear + base, depending on tool type)
\$TC_TPG9 = 5	Length 3 (geometry + wear + base, depending on tool type)
\$TC_TPG9 = 6	Radius

*: The tool parameter of cutting edge 2 is chained to the parameter of cutting edge 1 (see tool-specific grinding data \$TC_TPG2, chain rule). Here, typical chains are shown and the associated place value is specified in brackets.

Spindle number \$TC_TPG1

This parameter contains the number of the spindle to which the monitoring data and GWPS refer.

Chain rule \$TC_TPG2

This parameter defines which tool parameters of the right wheel edge (D2) and left wheel edge (D1) must be chained (see TOA data). If the value of one of the chained parameters is changed, it is then automatically included in the chained parameter.

It must be noted that the minimum grinding wheel radius must be specified in the Cartesian coordinate system for an inclined grinding wheel. The length compensations always specify the distances between the toolholder reference point and the tool tip in Cartesian coordinates.

The monitoring data apply to both the left-hand and the right-hand cutting edge of the grinding wheel.

The tool lengths are not automatically compensated when the angle is altered.

On inclined axis machines the same angle must be specified for the inclined axis and the inclined wheel.



Offsets that are not required must be assigned the value 0 (= default when the offset memory is set up).

The tool offsets can be entered not only via the operator panel front but also via the data input interface.

For programming offset data, see
/PG/, Programming Guide Fundamentals

5.2 Tool offset

5.2.1 Function and main screen Tool offset

Tool offset data consist of data which describe the geometry, wear, identification, tool type and the assignment to parameter numbers. The unit used for the dimensions of the tool is displayed. The input field is highlighted.

Parameter	CHAN1	AUTO	MPF.DIR	BEISPI.MPF	
Kanal RESET			Programm läuft		T-Nr +
			ROV SBL1		T-Nr -
Werkzeugkorrekturen			Neue Schneide		TO-Bereich 1
T-Nummer	34	D-Nummer	2	Schneidenanzahl	1
Werkzeugtyp	100				D-Nr +
Schneidenlage	3				D-Nr -
Längenkorrektur	Geometrie		Verschleiß		Basis
Länge 1	:	5.000	0.500	0.000	mm
Länge 2	:	2.000	0.500	0.000	mm
Länge 3	:	2.000	0.000	0.000	mm
Radiuskorrektur					Löschen...
Radius	:	0.000	0.000	mm	
DP7,16	res:	0.000	0.000		Gehe zu...
DP8,17	res:	0.000	0.000		
DP9,18	res:	0.000	0.000		Übersicht...
DP10,19	res:	0.000	0.000		
DP11,20	res:	0.000	0.000		Neu...
Technologie					
Freiwinkel	:	0.000	Grad		
DP25	res:	0.000			
Werkzeugkorrektur	R-Parameter	Settingdaten	Nullpunktverschieb.	Anwenderdaten	Aktive NV + Korrekt.
					Korrekturermitteln...

Every offset number contains up to 25 parameters, depending on the tool type.

The number of parameters shown in the window is that for the tool type.

The maximum number of offset parameters (T and D numbers) can be set by means of machine data.



Tool wear: Fine offset

If you at least have the right entered in MD 9202: USER_CLASS_TOA_WEAR, you can incrementally change the values of the tool fine offset. The difference between the old and new values must not exceed the limit stored in MD 9450: WRITE_TOA_FINE_LIMIT.

Tool offset

Selection of "Tool offset" menu

R-Parameter

Selection of "R parameters" menu

Setting data

Selection of "Setting data" menu

Work offset

Selection of "Work offset" menu

User data

Selection of "User data" menu

Determine offset

Support in determining tool offsets. This softkey is not required if the tool management function is available.

Vertical softkeys

The vertical softkeys support data input:

T-No.
+

Selection of the next tool

T-No.
-

Selection of the previous tool

D-No.
+

Selection of next highest offset number (cutting edge)

D-No.
-

Selection of next lowest offset number (cutting edge)

Delete...

Deletion of a tool or cutting edge

Go to...

Find any tool or the active tool

Overview

List of all available tools

New

New cutting edge or a new tool

5.2.2 New tool



Tool
offset

New...

New
tool

Abort

OK

OK + new
tool

OK + new
cutting

Function

If you create a new tool, the relevant tool types are automatically pre-selected as input support when you select the tool group.

Sequence of operations

The "Tool offset" window is displayed automatically.

Press the "New tool" softkey.

The "Create new tool" window appears on the screen.

Once you have entered the initial digits for the tool group, all the available tool types within the 5xx group will be displayed for you so that you can select one:

e.g., "5xx turning tools"

- 500 Roughing tool
- 510 Finishing tool
- 520 Plunge cutter
- 530 Parting tool
- 540 Threading tool
- 550 Steel profile
- 560 Rotary drill (ECOCUT)
- 580 oriented probe

Enter the digits for your selections via the alphanumeric keypad or select them from the displayed list.

No new tool is created.

A new tool is created.
The window is closed.

Creates another tool.
The window remains open so that you can create other new tools.

Creates another cutting edge for the tool you have just created.
The window remains open.

5.2.3 Display tool



Tool
offset

T-No.
+

T-No.
-

Function

You can select tools that you have created and access their tool offset data.

Sequence of operations

The "Tool offset" window is displayed automatically.

If the "Parameters" area has already been selected, the window and the last tool selected when the area was exited are displayed. The tool offset data of the current tool are displayed immediately. If no tool has yet been selected, the data of the first tool are shown together with its first D number. If no tools are available in the area, a message is output.

Select the created tools.

Additional information

Input of the geometry and wear data of the tool can be disabled using the keylock switch.

5.2.4 Deleting a tool



Tool
offset

T-No +/-
D-No +/-

Delete

Delete
Tool

Function

The tool is deleted together with all its cutting edges and the tool list updated accordingly.

Sequence of operations

The "Tool offset data" window is displayed automatically.

Scroll the screen contents until you reach the tool to be deleted.

The vertical softkey bar changes when the "Delete" softkey is selected.

Press the "Delete tool" softkey.

The tool and all its edges are deleted. The tool offsets of the tool number preceding the deleted tool are displayed.

5.2.5 New cutting edge



Tool
offset

New...

New
edge



Abort

OK

OK + new
cutting

OK + new
tool

Function

To help you to select a new cutting edge, the associated tool types are displayed automatically when you select a tool group.

Sequence of operations

The "Tool offset" window is displayed automatically.

Press the "New ..." and "New cutting edge" softkeys.

The "New cutting edge" window is displayed.

Once you have entered the initial digits for the tool group, all the available tool types within the 5xx group will be displayed for you so that you can select one:

e.g., "5xx turning tools"

- 500 Roughing tool
- 510 Finishing tool
- 520 Plunge cutter
- 530 Parting tool
- 540 Threading tool
- 550 Steel profile
- 560 Rotary drill (ECOCUT)
- 580 oriented probe

The possible cutting edge positions are displayed automatically for some tool types (e.g., for special tools, turning tools, grinding tools).

Enter the appropriate digit on the alphanumeric keyboard.

Creation of a new cutting edge is aborted.

A new cutting edge is created.

A new cutting edge is created.

Another new cutting edge can be created.

A new cutting edge is created.

Another new tool can be created.

5.2.6 Deleting a cutting edge



Delete

Delete
edge

Function

You can delete one or several edges of a tool. The tool list is updated automatically.

Select the cutting edge of a tool, press the "Delete" softkey and then the "Delete edge" softkey.

5.2.7 Determining a tool offset



Function

The "Determine tool offset" function allows you to change the absolute coordinates of different axes and then to calculate them.

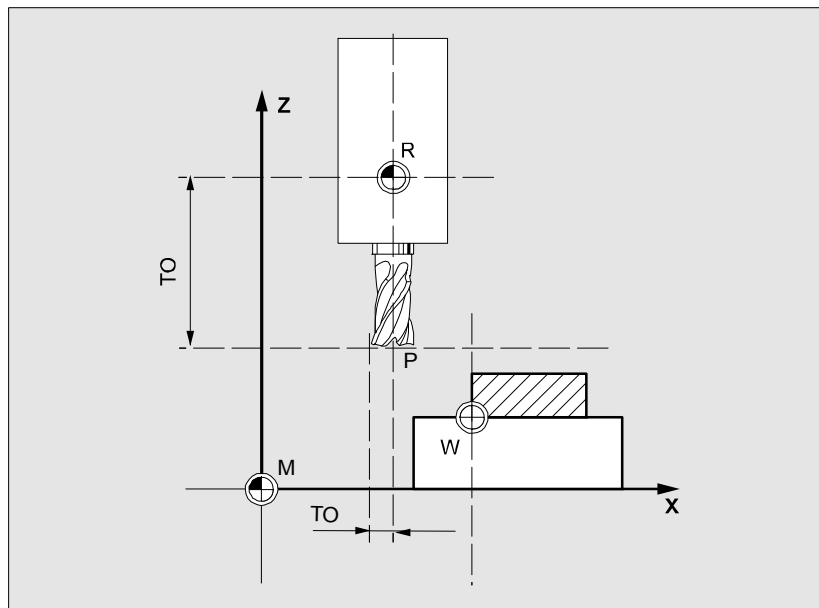

- TO** Tool offset, absolute coordinate
- R** Tool adapter point
- M** Machine zero
- W** Workpiece zero

The tool offset is only calculated in the machine coordinate system (MCS).





Tool offset

Determine offset



Calculate

OK



Sequence of operations

The "Tool offset" window is displayed.

Position the cursor on the tool parameter you wish to change.
The "Absolute coordinate" window opens.

Select the appropriate axis with the "Toggle key". Alter the reference value, if necessary, using the numeric keypad.

Position – reference value is entered in the input field.
The window remains open.

When you press the "OK" softkey, the current position and corresponding reference value for the selected tool parameter are calculated.

The following applies: Position – reference value = input value

The window is closed.

If "Jog" mode is selected, it is also possible to change the position by traversing the axes. The control automatically calculates the value from the reference value and the new position.

5.2.8 Make tool offset immediately effective



References



Function

The machine data can be set to specify that the active tool offset can be activated immediately if the part program switches to the "Reset" or "Stop" state.

Additional information

When the function is used in the Reset state, the machine data item \$MC_RESET_MODE_MASK must be set such that the offset is not reset when the program switches to Reset.

Function Manual Basic Functions (FB1): Axes, coordinate systems, frames (K2); Chapter "Additive offsets"

Caution

The offset is applied after NC Start of the Reset in response to the next programmed axis movement in the part program.

5.3 Tool management

The tool management system is organized by means of various configurable lists which show different views of the tools used.

Magazine list

In the "Magazine list", the tools of a magazine are displayed in order of ascending magazine location numbers.

You can search for, display and, in the majority of cases, edit the data. A function is also provided for checking the D numbers and subsequently activating tools.



This list is mainly used to load and unload tools during setup, and to move tools between magazines.

Tool list

In the "Tool list", the tools are displayed in the order of ascending T numbers.



You use this list if you are working with small tool magazines and know the exact magazine location of each tool.

Working offset list

The cutting edges of active replacement tools are displayed in the "Working offset list". They are sorted in order of ascending D numbers.

You can search (according to D number/DL number), display and edit the data.



Notice

Use this list to edit and monitor sum offsets (local offsets), quantities and cutting edge parameters during the machining process. You can configure up to three different views for the working offset list. The TOA is assigned to multiple channels and is effective in the channel in which the tool is active. If you want to change the wear in the list of working offsets without having to call the tool again at the next NC Start, ensure that the correct channel is selected for this tool.

Tool catalog and tool cabinet



The **tool catalog** contains only "ideal" tools.

"Ideal" tools are characterized by the relevant tool "master data" (i.e., with ideal tool dimensions, no wear, etc.). An "ideal" tool is uniquely defined by its "tool name".

The **tool cabinet** contains "real" tools only.

"Real" tools (i.e., real tool dimensions, with wear, etc.) are characterized by the relevant tool "offset data". A "real" tool is uniquely defined by its "tool name" and the associated "Duplo number". It is the "Duplo number" that assigns actual data to a "real" tool.

If a connection to a host computer exists, a message is automatically output to this host computer when a tool is loaded (but not relocated), unloaded or deleted, and the corresponding data block is transferred. The data are then still available on the host computer even after the tool has been deleted.

Machine manufacturer

Please refer to the information supplied by your machine manufacturer to see which functions are included in your tool management.

See /FBW/ Description of Functions, Tool Management or /FBSP Description of Functions, ShopMill

5.3.1 Main tool management functions

Tool
managem.

The tool management system offers various tool types for selection. You can assign geometric and technological data to the tool types in order to set up your master tool data. Several versions of each tool can exist. You can assign the current data of the tool used (particular tool data) to these versions.

You start the tool management function from the "Parameters" operating area by pressing the relevant softkey.

The machine manufacturer configures which list is to be displayed when the tool management system is called up. In the example shown, the current "Magazine list" is displayed.



Important!

The structure of the table is **freely configurable** (configured by the machine manufacturer).

The **example** shows only one possible case:

Parameter	CHAN1	AUTO	MPF.DIR LEER.MPF
<input checked="" type="checkbox"/> Kanal RESET			Programm abgebrochen ROV FST

Magazinliste 1

Magazin: Plätze: AVB:

PI	PP	PTP	WerkzeugID	Dupl	TNr	PTT	W	W	W	W	W	PV	WTyp	xGeo-L1	xGeo-L2	
1	-	-	newRack860	1	1	1	-	F	G	M	V	-	0	900	11.0000	11.0000
2	-	F	Wzg1	1	76	1	-	F	-	-	-	-	0	900	0.0000	0.0000
3	-	F	1										0			
4	-	-	1										0			
5	-	-	Wzg2	1	85	1	-	F	-	-	-	E	0	900	0.0000	0.0000
6	-	F	Wzg3	1	7	1	-	F	-	-	-	-	0	900	0.0000	0.0000
7	-	F	1										0			
8	-	F	1										0			
9	-	F	1										0			
10	-	F	1										0			
11	-	F	1										0			
12	-	F	1										0			
13	-	F	1										0			
14	-	F	1										0			

Magazinliste

Werkzeugliste

Beladen

Entladen

Umsetzen

Arbeitskorrekturen

Magazinliste 1

Magazinliste 2

Magazinliste 3

Werkzeugdaten

D-Prüfung, Aktivieren

Zwischenspeicher

Suchen u. Position.

Nächstes Magazin

Location (PI)

Location number

Location state (P)

Location state

(one column is provided for each state)

For example

F = Location enabled

G = Location disabled

Z = Reserved for tool in buffer

B = Reserved for tool to be loaded

L = Left half location occupied

R = Right half location occupied

O = Upper half location occupied

U = Lower half location occupied

l = Left half location reserved

r = Right half location reserved

o = Upper half location reserved

u = Lower half location reserved

PTP

Type assigned to the location

Tool ID

Name of the tool

Dupl	Number of replacement tool
TNo	Internal T numbers, which may be needed for reloading tool data.
PTT	Type of location assigned to the tool
W (8x)	<p>Tool status (one column is provided for each status) No display = Replacement tool</p> <p>A = Active tool F = Tool enabled G = Tool disabled M = Tool is measured V = Warning limit is reached W = Tool is being changed P = Tool is fixed-location-coded E = Tool has been in use R = Unloading marking ("radius") B = Loading marking S = Master tool</p>
PV	Wear group assigned to the tool.
WTy	<p>Tool type Only some of the tool offsets are enabled for input, depending on the tool type. All other tool types are preset to a value of 0.</p>
Geo – Len 1 Radius ...	Tool offsets such as length, radius, wear, monitoring data, etc.

Horizontal softkeys

Magazine list	The first or most recently displayed magazine is shown in the "Magazine list" together with all the tools which have been loaded. You can access the next magazine by pressing the corresponding vertical softkey.
Tool list	All tools which are stored as a set of data on the NC are displayed (irrespective of whether they have been assigned to a magazine location).
Load	A magazine location is assigned to the tool.



The tool is deleted from the current magazine location.



The tool is moved from the current magazine location to another location.



The cutting edges of active replacement tools are displayed. They are sorted in order of ascending D numbers.



Further softkeys are displayed when you press the "ETC." key:



You can create new tool master data ("ideal" tools) and edit the existing data.



You can create new tool offset data and tool operating data ("real" tools) and edit the existing data.



This softkey allows you to display the tool data as transformed data (adapter data are calculated) or non-transformed data.



This conversion feature is only available in the magazine list display. The data are always displayed as non-transformed data in the tool list and as transformed data in the working offset list.

Special feature:

If you display transformed data and want to create a new tool in the magazine list (loading mode), the transformed data display is activated exclusively for input of this data block.

Vertical softkeys (magazine list)

(Names assigned by user)



Selection of user-specific display windows (if configured), e.g.,



- General data
- Geometry data
- Wear data



Tool data

You can display and edit the complete data of a tool.

Call up the start screen for updating the tool data. You can display and normally also edit all the data of the tool, its cutting edges and its working offsets in this screen and subsidiary screens. The vertical softkey bar changes.

The exact procedure is described under "Display/edit tool data" (see Page "Display/edit tool data").

Activate
D check

Two functions are implemented with this softkey:

- Verify unique D number assignment
Duplication can occur when assigning D numbers to the cutting edges of the individual tools. This function checks all numbers within the current magazine or all allocated D numbers within a TO unit (configured by parameter).
- Activate the tools
If unique D numbers were assigned, a wear group is activated. A tool is subsequently activated from each replacement tool group in the TOA of the current channel. Allowance is made for the active wear group.

Only automatically accessible magazines are considered for processing. Any previously active tools are disabled by the activation of tools, especially if the wear group is changed.

Buffer

Display and hide the buffer window in the magazine list. The display shows spindles, grippers, etc., i.e., locations which can accommodate tools but which are not magazine locations. If no buffer is defined, this key has no function.



Search &
position.

The "Find tool/location" window appears.

- Search
 - Tool:
Enter the tool name and Duplo number and start the search with OK.
The cursor is positioned on the tool found.
 - Location:
Enter the magazine and location number and start the search with OK.
The cursor is positioned on the tool found.
- Positioning
Select the "Position" softkey,
tool/location is moved to loading point. If there is more than one possible loading point, a window is opened. You can select the correct one with the cursor.

Next
magazine

The locations of the next magazine are displayed in the magazine list.

You can only scroll forwards. When you reach the last magazine, the display returns to the first magazine.



(Names assigned by
user)

Tool
list 1

Tool
list 2

Tool
list 3

Tool details

Tool
from CC

Tool in
cabinet

Vertical softkeys (tool list)

Selection of a table structure configured by the user
(if configured), e.g.:

- General data
- Geometry data
- Wear data

You can display and edit the complete data of a tool (as in the magazine list).

The tool data are read from a code carrier and entered in the tool list (you can then edit the data).

Select the tool in the tool cabinet.

The tool data are read from there and entered in the tool list.

A list display appears for which you can parameterize a filter for the tool number, duplo number and tool type. The list displays all the tools that fulfill the filter criteria. You can select the tool you require from the list.

Delete tool

The selected tool is removed from the list. Use the vertical softkeys to determine whether to save the tool data.

Tool in cabinet

The data are copied into the tool cabinet. The tool can be loaded later with the same data.

Data on CC in cabinet

If a code carrier is installed, the tool data are stored on the carrier. The tool can then be loaded later with the same data.

Abort

The operation is canceled. The tool is not removed from the list.

OK

The tool is deleted from the list. The tool data are no longer available.

New tool

Each time you press this softkey, a tool is created **immediately**. The screen form for entering the tool data (tool details) and the associated softkey bar (same as tool details) appear. The values are initialized with the default settings (configured in the INI file) and can be edited here (e.g., you can change the name of the tool).

Use the vertical softkey bar to display the tables for cutting edge data and offsets with the default settings. If necessary, enter any changes in the individual views.

<<

Terminates input of the tool data and switches to the tool list display. The new tool appears in the table and is available for loading.

Once you have set up a new tool, the cursor automatically jumps to the line containing the new tool when you return to the tool list. This gives you feedback about your operation.



Note

The data you enter are always updated immediately (without prompting). You can edit the properties of the new tool by pressing the "Tool details" softkey.

It is not possible to edit the data directly in the table.

You can only edit the name and type of a tool by selecting Create New, not via Tool details.

To change a name, you have to create a new tool and delete the old one.

Vertical softkeys (working offset list)

(Names assigned by user)

W. offset
list 1

W. offset
list 2

W. offset
list 3

Tool data

Find
D number

Current
D number

Selection of a table structure configured by the user (if configured), e.g.:

- General data
- Geometry data
- Wear data

You can display and edit the complete data of a tool (as in the magazine list).

Find an entry with a specific D number/DL number.

- Enter the D number and DL number you want to find in the search window.
- Confirm with "OK". If a matching entry is found, the cursor jumps to the corresponding line. If you have not specified a DL number, the cursor is positioned on the first line of the matching tool.

The D number of the current tool is determined and displayed.

5.3.2 Displaying/editing tool data



Tool
managem.

Magazine
list

Tool list

Working
offset

Tool details

Function

You can view and edit the tool data of the tool selected in the lists.

You can edit the following cutting edge data:

- Corrective values
- Monitoring data
- User data

Sequence of operations

Press the "Tool management" softkey.

The list configured by the machine manufacturer appears (e.g., the magazine list). The horizontal and vertical softkey bars change.

Select the appropriate list via softkey:

- "Magazine list"
- "Tool list"
- "Working offset list"

Position the cursor bar on the appropriate tool. The tool is selected.

Notice:

Please ensure that the channel in which the offsets are to be applied is displayed.

Select the "Tool details" softkey.

The input screen for "Tool details" appears.

The vertical softkey bar changes again.

The following functions are available:

- Create new cutting edges
- Edit cutting edge data
- Edit monitoring data
- Edit local offsets (DL numbers)
- Delete cutting edges

You can edit the following data in the input screen :

- Location type
- Location coding
- Monitoring type
- Status (enabled, disabled, measured, etc.)
- Tool user data (Omit; x = 1...10)
- D numbers
- Tool name
- Duplo number
- Tool type, only in magazine list and tool list



Note

The tool data name, duplo number and type can only be changed if the option has been enabled by the machine manufacturer. If the option is not activated you cannot make any changes. These data are permanently defined when a new tool is created.

New cutting edge

New cutting edges are created for the displayed tool. A cutting edge number to which no D number has yet been assigned is automatically selected in the table.

When you have allocated a D number, the value is displayed in red (the cutting edge has not yet been created). Select "Cutting edge data" in the vertical softkey bar. The selected cutting edge is created. Default values are assigned to the cutting edge data and the corresponding table is displayed. Enter any necessary changes.



You can use the "Cutting edge +" and "Cutting edge -" softkeys to display and, if necessary, edit the data of the other cutting edges. The data are updated immediately.

Press the "<<" softkey to return to the Tool details input screen. The new cutting edge is defined. The display color changes.

Additional information

If twelve cutting edges have already been defined for the tool, you must delete one of the cutting edges (via softkey) before you can create a new one.

The machine manufacturer can limit the maximum permissible number of cutting edges for each tool to a smaller number. The default setting is nine cutting edges.

Edit tool data

A new cutting edge can be added to a tool at any time (even if the tool is already located in the magazine). Select "New cutting edge" and enter the cutting edge data.

Press the "Cutting edge data", "Mon. data" and "Local offsets" softkeys to display tables for editing the respective data. You can move freely between the individual tables. The name, Duplo number and type of tool and all defined cutting edges (#1...#12) are displayed. Use the "Cutting edge +" and "Cutting edge -" softkeys to toggle between the cutting edges. Press "<<" to return to the "Tool details" input screen.

Note

When you edit the data, the new data is saved immediately. The "<<" softkey only changes the display.

The cutting edge data and tool offsets of the currently selected cutting edge are displayed and can be edited.

You can edit the following data:

- Cutting edge user data (OEM_Sx; x = 1...10)
- Tool offsets
 - Geometry
 - Wear
 - Basic offset
 - Cutting edge position (for turning tools)
 - Tool clearance angle (for turning tools)

You can define the value of Length1, Length2, Length3 and Radius1 for every parameter.

The monitoring data of the currently selected cutting edge are displayed and can be edited.

When you have selected a cutting edge, define the actual value, setpoint and warning limit monitoring data for the following parameters:

- Quantity
- Tool life
- Wear

Cutting edge data

Monitoring data

Loc. dep.
offsets

The tool offsets (identical to the cutting edge data table) and the local offsets of the currently selected cutting edge are displayed and can be edited.

The following options are available:

- Values can be defined for Length1, Length2, Length3 and Radius1 for each parameter.
- Up to six local offsets (DL1...DL6) are possible (according to the machine manufacturer's configuration).
- Setup values and wear values can be defined for each offset.

Edge +

In the individual tables, this softkey displays the data/offsets of the **next** cutting edge for editing.

Edge -

The data/offsets of the **previous** cutting edge are displayed and can be edited.

Delete
edge

In the table, select the cutting edge you want to delete (by positioning the cursor).

The cutting edge is deleted when you activate the softkey.

Important: There is no separate prompt.

The D number is removed from the table and can be reallocated.

<<



Terminates input of the tool data and returns to the table displayed previously.

Note



You can enter individual tool data items directly in the current list, provided you have the necessary access authorization and the data are displayed in the list (the list structure is configurable).

Select the value to be edited and enter the required data. The system automatically switches to edit mode.



5.3.3 Change in the significance/representation of tool wear values

Symbols  

In the tool list screens, additional symbols indicate whether special features have to be taken into account for the current tool according to G code 56 and setting data SD 42935: WEAR_TRANSFORM.

TRANSFORMIERT: Arbeitskorrekturen Liste 1					
Zeil	Aktuell	Werkzeug-ll	Dupl	DNo	Mag
1	 REV2	REI1	1	10	4
2		REI1	1	11	4
3		REI1	1	12	4
4		REI1	1	13	4
5		REI2	1	20	
6		REI2	1	21	4
7		REI2	1	22	4
8		REI2	1	23	4
9	 HAND	REI3	1	30	5
10		REI3	1	31	5
11		REI3	1	32	5
12		REI3	1	33	5
13		REI4	1	40	5
14		REI4	1	41	5
15		REI4	1	42	5
16		REI4	1	43	5



Arbeitskorrekturen R-Parameter Settingdaten Nullpunktversch

The G56 reset value is TOWSTD   and at least 1 bit in \$SC_WEAR_TRANSFORM is set.

The current tool for channel "REV2" is indicated in row 1. The current value of G56 on channel "REV2" deviates from the G56 reset value .

Row 9 displays the current tool for channel "HAND". There the current value of G56 is equal to the reset value (.

Symbols 

TRANSFORMIERT: Arbeitskorrekturen Liste 1					
Zeil	Aktuell	Werkzeug-Id	Dupl	DNo	Mag
1		REI1	1	10	4
2	 REV2	REI1	1	11	4
3		REI1	1	12	4
4		REI1	1	13	4
5		REI2	1	20	 4
6		REI2	1	21	4
7		REI2	1	22	4
8		REI2	1	23	4
9		REI3	1	30	5
10		REI3	1	31	5
11	 HAND	REI3	1	32	5
12		REI3	1	33	5
13		REI4	1	40	5
14		REI4	1	41	5
15		REI4	1	42	5
16		REI4	1	43	5



Arbeitskorrekturen Werkzeug-Liste

The G56 reset value is TOWMCS  and
\$SC_WEAR_TRANSFORM is set.

The current tool for channel "REV2" is indicated in row 2. The current value of G56 on channel "REV2" deviates from the G56 reset value .

Row 11 displays the current tool for channel "HAND". There the current value of G56 is equal to the reset value (.

Symbols 

TRANSFORMIERT: Arbeitskorrekturen Liste 1					
Zeil	Aktuell	Werkzeug-Id	Dupl	DNo	Mag
1		REI1	1	10	4
2		REI1	1	11	4
3		REI1	1	12	4
4		REI1	1	13	4
5		REI2	1	20	4
6	  REV2	REI2	1	21	4
7		REI2	1	22	4
8		REI2	1	23	4
9		REI3	1	30	5
10		REI3	1	31	5
11		REI3	1	32	5
12		REI3	1	33	5
13		REI4	1	40	5
14		REI4	1	41	5
15	 HAND	REI4	1	42	5
16		REI4	1	43	5

Arbeitskorrekturen Werkzeug-Liste

The G56 reset value is TOWWCS  and \$SC_WEAR_TRANSFORM is set.

The current tool for channel "REV2" is indicated in row 6.

The current value of G56 on channel "REV2" is the same as the reset value (.

Row 15 displays the current tool for channel "HAND". Here, the current value of G56 deviates from the G56 reset value (.

Additional information

Additional information can be found in:
Function Manual Tool Management

5.3.4 Grinding data expansion



Function

If the selected tool is a grinding tool, a vertical softkey 6 "Grinding parameters" is provided in the following:

- Tool details main screen
- Tool details cutting edge data (sub)screen
- Tool details monitoring data (sub)screen

When this softkey is pressed, a display appears where grinding parameters can be:

- Display
- Edit

Werkzeug Schleif-Daten			
Name:	SCHLEIFER220	Duplo:	2
Typ:	403 Umf-Schleifscheibe mÜ oB		
Schneiden:	#1	#2	#3
D	1		
Maximale Drehzahl	10000.000		[U/min]
Maximale Umfangsgeschwindigkeit	130.000		[m/s]
Minimaler Scheibradius	220.000		[mm]
Minimale Scheibenbreite	140.00		[mm]
Aktuelle Scheibenbreite	160.000		[mm]
Winkel der schrägen Scheibe	30.000		[grad]
Spindel-Nummer	1		
Parameter-Nummer für Radiusberechnung	3		
Verkettungsvorschrift	9		
OEM_T1 [mm]	0.000	OEM_T2 [mm]	0.00
OEM_T3 [mm]	0.000	OEM_T4 [mm]	0.0000
OEM_T5 [mm]	0.00000	OEM_T6 [m/s2]	0.000
OEM_T7 [U/s2]	0.000	OEM_T8 [m/s3]	0.000

Arbeits-korrekturen | Werkzeug-Liste | Magazin-Liste

This display contains the following:

Top section:

- Tool name
- Duplo number
- Type
- Cutting edge navigation bar
as in the "Cutting edge data" display for tool details
(The data is only displayed and cannot be modified)

Middle section:

The data correspond to the system variables entered for grinding.

Variable for	Unit	Name of identifier
Spindle number	-	\$TC_TPG1
Chaining rule	-	\$TC_TPG2
Minimum wheel radius	[mm, in]	\$TC_TPG3
Minimum wheel width	[mm, in]	\$TC_TPG4
Current wheel width	[mm, in]	\$TC_TPG5
Maximum speed	[rpm]	\$TC_TPG6
Maximum peripheral speed	[m/s, ft/s]	\$TC_TPG7

Angle of the inclined wheel [degrees] \$TC_TPG8
 Parameter number for radius calculation/compensation - \$TC_TPG9
 parameter for GWPS

Additional information

For information on NC variables, please refer to the Function Manual /FB/, W4 Grinding-specific tool offset and monitoring.

Bottom section:

Tool OEM data are displayed as on the main screen for tool details. The tool OEM data can be edited on both the grinding parameters screen and the main tool details screen. The designation and the unit in the OEM data can be parameterized in the relevant language. The bottom section of the display is only available if tool OEM data are available on the NC.

Scroll bar

A scroll bar appears next to the middle and bottom sections if the bottom section is displayed.

The grinding parameters screen and the softkeys are only displayed if the tool is a grinding tool (tool type between 400 and 499). Access rights are checked for grinding parameters. Default access is "All". All tool cutting edges are of the same type. The same applies to the dresser cutting edges of grinding tools.

Tool types

The tool types for grinders are 4xy in accordance with /FB/, W4. They are available in displays/functions for:

- Tool cabinet
- Tool catalog
- Cutting edge parameters in tool details
- Lists (magazine list, tool list, working offset list)

Limitations

- The tool-specific grinding parameters cannot be displayed in the list displays.
- They are not saved in the tool cabinet/tool catalog.
- They are not transferred via code carrier/SINCOM.
- The extension is available in HMI Advanced Version 6.2 or later.

5.3.5 Load



Function

You can load a tool in one of the following ways:

- You can enter the individual tool data directly in the list.
- You can import tool data from existing tools.

You can load a tool from the "Magazine list" or the "Tool list".

- **Loading a tool from the "Magazine list"**

To edit tool data directly in the list, you must first find a suitable empty location for the tool (use the softkeys). You can then enter the data directly in the list.

You can also load all existing tools into the magazine.

You load the associated tool data:

- From the master data catalog
- From the tool cabinet
- From the code carrier (if one exists) or
- From the host computer (if one is connected).

In this case, the system automatically tries to find a suitable empty location for the selected tool.

- Loading a tool from the "Tool list"

Tools for which data are already stored in the TO memory can be loaded into the magazine.

The magazine location is selected either by searching for an empty location or by entering a magazine number and location number in the corresponding columns of the list.



Tool
managem.

Magazine
list

Load

Manual data input (with search for empty location)



Additional information

In the lists, you can parameterize a filter for loading tools. A list display appears for which you can parameterize a filter for the tool ID, duplo number and tool type. The list then displays the tools in the tool cabinet that meet the filter criteria. By selecting it from the list, you accept the tool.

Sequence of operations (loading from the "Magazine list")

Press the "Tool management" softkey.
The "Magazine list" is displayed.
The horizontal and vertical softkey bars change.

The "Magazine list" is selected.
The appropriate magazine is selected.

Press the "Load" softkey.
The vertical softkey bar changes again.

If you want to enter data directly in the table, you must first find a suitable empty location in the magazine.

There are four methods by which you can find an empty location for different tool sizes in combination with location types:

1. Directly in the magazine list ("Manually").
2. Via a user-defined location
e.g., "oversize" (name configured by machine manufacturer)
3. Via the "Find empty location" softkey
4. Via the "To loading point" softkey

Additional information

Values are checked for validity when you enter a tool type in the lists. Only known tool types are permitted.

Searching directly in the magazine list

Position the cursor on the location of your choice in the magazine list.

Search via user-defined location (example)

The assignment of the softkeys is configured by the machine manufacturer.

Normal

- "Normal" (name configured by machine manufacturer)
- "Large" (name configured by machine manufacturer)
- "Oversize" (name configured by machine manufacturer)
- "Normal and heavy" (name configured by machine manufacturer)

Large

Oversize

Normal and heavy

The system searches for a suitable empty location.
The cursor bar is automatically positioned on the magazine location found in the "Magazine list".

Find empty location

Search via the "Find empty location" softkey

Enter the "Tool size" and "Location type" in the query window.
If more than one loading point is configured, select the desired loading point from a query window.
The system searches for the corresponding empty location.
The cursor bar is automatically positioned on the magazine location found in the "Magazine list".

To loading point

Search via the "To loading point" softkey

You have found an empty location in front of the current loading point.
When you press "To loading point" the cursor is automatically positioned at this location.

Tool details

Enter data

If the desired empty location is found after a search operation, the system switches to edit mode and the softkey bar changes. When you search for an empty location manually, the system switches to edit mode as soon as you start entering the data on the keyboard.

You can use the "Tool details" display to edit the data of the tool to be loaded (if necessary).

If the tool has not yet been created, it is created automatically when you call the input screen.

Abort

Load/input mode is canceled.

A tool created via "Tool details" or "Start" is deleted. You can search for another empty location.

Start

The loading operation is initiated. If the tool has not yet been created, it is created automatically.



Import tool data

Data from
CC

Data from
host

Tool in
cabinet

Tool details

Abort

Start



If data are still missing for loading, the tool details input screen appears. The missing data are initialized with default values and can be edited if necessary. Start the loading operation again afterwards. In addition to direct data entry, there are various ways of importing tool data belonging to tools which have already been defined and of subsequently loading these tools:

1. Read-in the data in from a code carrier (if one is installed)
2. Read-in the data in from a host computer (if one is installed)
3. Select the "Tool from cabinet" menu.
Select the tool in the tool cabinet. The tool data are read from there.

If not all of the softkeys are visible, change the display by pressing the appropriate key on the operator panel front.

When you have defined the source for loading, the system automatically tries to find a suitable empty location for the tool to be imported. The vertical softkey bar changes.

If no location is found, an error message is displayed.

You can use the "Tool details" display to edit the data of the tool to be loaded (if necessary).

If the tool has not yet been created, it is created automatically when you call the input screen.

Load/input mode is canceled.

A tool created via "Tool details" or "Start" is deleted. You can search for another empty location.

The loading operation is initiated. If the tool has not yet been created, it is created automatically.

"Load directly to spindle" is possible if the cursor is positioned on the spindle buffer location.



Tool list

Sequence of operations (loading from the "Tool list")

The "Tool list" is selected.
The appropriate tool is selected.

Load

Press the "Load" softkey.
The vertical softkey bar changes.

Find empty
location

Search for an empty location for a tool which has already been created or enter the desired location and magazine number in the list.

The location found is entered under the magazine/location number.

Abort

The loading operation is not initiated.
The main screen appears.

Start

The loading operation is initiated.

5.3.6 Unload



Function

This function allows you to unload a selected tool and to save its data.



Tool
managem.

Sequence of operations

Press the "Tool management" softkey.
The "Magazine list" is displayed.
The horizontal and vertical softkey bars change.
You can unload a tool from the "Magazine list" or the "Tool list".

The sequence of operations is the same for both methods.

Magazine list

Tool list

Unload

Tool in cabinet

Data on CC in cabinet

From magazine



Delete tool



Select the appropriate list via softkey:

- "Magazine list"
A tool is to be physically removed from a magazine location. You can configure whether the corresponding NC block is also removed from the TO memory.
Select the magazine and the tool to be unloaded (select the tool with the cursor).

or

- "Tool list"
The NC block is to be unloaded from the memory. Select the tool to be unloaded (select the tool with the cursor).

Select the "Unload" softkey.
The vertical softkey bar changes.

The tool data of the selected tool are stored in the tool cabinet on the hard disk. This allows you to load the tool with the same data again at a later point.

If a code carrier is installed, the tool data are automatically stored there. This allows you to load the tool with the same data again at a later point.

The selected tool is unloaded.
The corresponding line is deleted from the magazine list.
The entries in the magazine number and location number columns are removed from the tool list.

"Unload directly from spindle" is only possible if the buffer is selected and the cursor is positioned on the location of the spindle.

To exit the screen **without** unloading the tool, select another display in the vertical softkey bar **before** pressing "Start".

The tool data of the selected tool are deleted from the TO memory. If the tool is in a magazine location, it is unloaded and deleted.

If a host computer is connected, the data are transferred to the host computer each time a tool is deleted or unloaded.

5.3.7 Relocating



Tool
managem.

Magazine
list

Tool list

Relocate

Function

This function allows you to move a selected tool from one location to another.

Sequence of operations

Press the "Tool management" softkey.
The "Magazine list" is displayed.
The horizontal and vertical softkey bars change.

You can relocate a tool from the magazine list or the tool list. The sequence of operations is the same for both methods.

Select the appropriate list via softkey:

- "Magazine list"
Select the magazine and the tool to be relocated (position the cursor on the magazine location containing the tool).

or

- "Tool list"
Select the tool to be relocated
(position the cursor on the tool).
This tool must already have been loaded
(entry in the magazine number and location number columns).

When you select the "Relocate" key, the "Relocate tool" window opens.

There are 2 methods by which you can select the new location for the tool:

- Enter the magazine and location numbers in the "Relocate tool" window.

or

- Press the "Find empty location" softkey and select the desired data in the window.

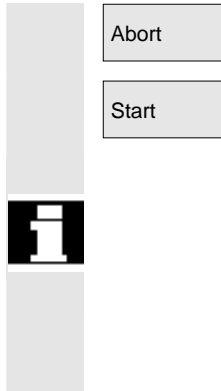

The tool is not relocated.

The tool is relocated to the new empty location.

Use magazine number 9998 to move a tool to or from a spindle location.

When relocating from the buffer, the previous location information is entered by default. This applies to fixed-location-coded and variable tools.

5.3.8 Tool master data in the tool catalog



Function

You can create tool master data in the tool catalog. A set of data can be created for every tool in use.

Advantage

Master data which apply to the tool, regardless of which cutting edge you use, do not have to be reentered for each tool, but can be copied from the tool catalog (in the tool cabinet) for each tool used.

Ideal tools



The **tool catalog** contains only "ideal" tools.

"Ideal" tools are characterized by the relevant tool "master data" (i.e., with ideal tool dimensions, no wear, etc.). An "ideal" tool is uniquely defined by its "Tool name".



Tool
managem.

Sequence of operations

Press the "Tool management" softkey.
The horizontal and vertical softkey bars change.



The horizontal softkey bar is expanded.

Tool
catalog

Press the "Tool catalog" softkey.
The vertical softkey bar changes again. The tool details of the tool catalog are displayed.

You can use the list fields to display the available standard tools and tools which have already been defined or to create new tools.

Create tool data

Proceed as follows to create the tool data:

- Select the desired technology in the appropriate list field (e.g., drilling tools, milling tools).
- Define the tool type in the second list field (e.g., twist drill).
- Activate this softkey to create a new tool.
You can edit the field for the tool name.
- Enter a tool name.
- In the open window, "Tool details", define the tool properties (in "Tool size" you define the total number of tool half locations occupied by the tool).
- Select "Abort" to discard the settings.
The tool is not created.
- Save your data with OK.
The new tool is created.

New

Abort

OK

Display /edit tool data

In addition to the tool master data already defined, you can enter default settings in the tool catalog for all the other tool data (e.g., cutting edge data, user data). You can edit this data later.
Duplo number 0 is allocated to the tool.



Offsets

Tools in the tool catalog are used as a basis for real tools. It is recommended to define only data actually required in that exact form for several real tools. This helps to minimize the amount of changes required later.

Tool data are displayed and edited as follows:

- Tool offset data (cutting edge data)
The tool offset data window is displayed. The data of the first cutting edge are listed in a table. The vertical softkey bar changes. Enter the required settings.

The following functions are available for editing the cutting edge data:

Edge +

The cutting edge data of the next defined cutting edge are displayed in a table.

Edge -

The data of the previous cutting edge are listed.

New

A new cutting edge is created for the tool.

Delete

The current cutting edge and all the data defined for the cutting edge are deleted after a prompt.

Abort

Select "Abort" to discard the changes.
No new cutting edge is created.

OK

Save the cutting edge data with "OK".
A new cutting edge is created (if defined).

Cut. edge
user data

- Cutting edge user data (if configured)
Switches to the "Cutting edge user data" input screen.
Up to 10 user-specific cutting edge data are displayed here.
Enter the required settings in the table.

Tool user
data

- Tool user data (if configured)
Switches to the "Tool user data" input screen.
Up to 10 user-specific tool data are displayed here.
Enter the required settings in the table.

Additional functions

Copy

The following functions are also available in the tool catalog:

The data of the tool are copied and a new tool is created with identical data. You are prompted to enter a name for the new tool.

Delete

The currently selected tool is deleted after a prompt. All data relating to this tool are lost.

Additional information

The "Tool offset data", "Cutting edge user data" and "Tool user data" softkeys are always displayed when you edit the tool details. This allows you to toggle between the individual tables as required.

The tool data for tools of the catalog can be edited at any time.

5.3.9 Tool offset data in the tool cabinet**Function**

You can create tool offset data in the tool cabinet. A set of data can be created for every tool in use.

The "ideal" master data defined in the tool catalog can be copied to the tool cabinet.

Advantage

Tools which have already been used can be stored in the tool cabinet before they are unloaded from the magazine. The current data, such as the remaining tool life, remain stored and can be accessed again the next time the tool is loaded.

You can also enter the tool data of tools which you plan to use in future (like the tools in a real tool cabinet).

Real tools

The **tool cabinet** contains "real" tools only. "Real" tools (i.e., real tool dimensions, with wear, etc.) are characterized by the relevant tool "offset data".

A "real" tool is uniquely defined by its "tool name" and the associated "Duplo number". It is the "Duplo number" that assigns actual data to a "real" tool.



Tool
managem.



Tool
cabinet

Create- tool offset data

Abort

OK



Sequence of operations

Press the "Tool management" softkey.
The horizontal and vertical softkey bars change.

The horizontal softkey bar is expanded.

Press the "Tool cabinet" softkey.
The vertical softkey bar changes again.

In order to add a tool to the tool cabinet, it must first be created in the tool catalog.

You create a real tool by defining a new Duplo number in the tool cabinet.

Please proceed as follows:

- Select the desired technology, tool type and tool successively in the appropriate list fields.
- Define the Duplo number.
The tool master data are loaded into the tool cabinet. The editing functions are available.
- Use the vertical softkeys to make all the necessary changes to the cutting edge data and user data.
- Select "Abort" to discard the settings.
The tool is not created.
- Select "OK" to save the changes.
The tool is created with the current offset data.

The defined tool data can be edited at any time. You can overwrite the data for the current tool or allocate a new Duplo number to create a replacement tool.

Display/edit tool data

The vertical softkeys can be used to display and edit the data for tools already stored in the cabinet:

Offsets

- Tool offset data (cutting edge data)
Enter the required offset values. The design of the vertical softkeys is identical to the tool catalog softkeys (see previous section under offsets).



A new cutting edge can be added to a tool at any time (even if the tool is already located in the magazine).

Cut. edge
user data

- Cutting edge user data (if configured)
Up to 10 user-specific cutting edge data entries are displayed here. Enter the required settings in the table.

Tool user
data

- Tool user data (if configured)
Up to 10 user-specific tool data entries are displayed here. Enter the required settings in the table.

Abort

- Select "Abort" to discard the settings.
The data retain their old values.

OK

- Press "OK" to accept the changes.
The data are updated.

Additional functions

The "Delete" function is also available in the tool cabinet. It is not possible to copy or create a new ideal tool here (only in the tool catalog).

Delete

The currently selected tool is deleted from the tool cabinet after a prompt.



All data of the tool with this Duplo number are lost. The master data in the tool catalog are not affected (tool with Duplo number 0).



Additional information

The "Tool offset data", "Cutting edge user data" and "Tool user data" softkeys are always displayed when you edit the tool details. This allows you to toggle between the individual tables as required.

A tool entered in the cabinet can be loaded to a magazine location via the "Tool from cabinet" softkey.

5.3.10 Job processing of tools



Applications

Function

The "Batch processing of tools" function allows the user to:

- Load and unload, delete and store tools in the cabinet in a single process for several tools.
- Monitor the progress of execution.
- Utilize the "Reactivate tools" function.

Parameterizable filters are used to select the tools. These enable you to create a snapshot of the tool data inventory of the NC containing all tools with the properties specified in the filter definition, e.g., all tools with particular tool status bits set, with a particular tool type, with a certain length, with particular OEM data, etc.

The search is carried out exclusively in the NC.

Batch processing for tools can be initiated via the operator interface and monitored there. Loading, unloading and reactivation can take place in the background, even if the associated interface is not active. The filter definition and some of the interface settings are carried out in the paramtm.ini and patm_xx.ini files for tool management.

Application

The machine operator can use the "Batch processing for tools" function to perform the following operations for sets of tools according to predefined filter criteria:

- Load
- Unload and
- Reactivate

The function is available within the tool management.

The parameters and other settings for the filter criteria are made in the paramtm.ini file without a separate operator interface.

Functional Description**Operator interface:**

The "Batch processing for tools" function is selected via the "Filter lists" horizontal softkey from the basic states of the magazine and tool lists in the tool management.

There are three states relating to "Batch processing for tools", which are represented by different screens:

1. **Filter selection**
2. Displays the **hit list**, enables tool selection and selection and start of batch processing in 2 screens: Load batch list and standard batch list.
3. **Batch execution**

Each TOA (data area for tool offsets) has a separate state. You can exit the "Filter lists" in these states and display different tool management screens or switch to other operating areas.

The next time you press the "Filter lists" horizontal softkey, the screen for the noted state is displayed.

The 2nd state "Hit list" stores the hit list and the tool selection as a snapshot.

The 3rd state "Batch execution" stores the data for the selected tools and the batch type. You can exit the "Filter lists" during batch processing. After returning to the "Filter lists", the new status of batch processing is displayed. The status of the batch as a whole and the states of the individual batch elements are visible.

Paramtm.ini

You can set the user rights for the softkeys involved in the paramtm.ini file (section [ACCESSLEVEL], entries "SKB...").

The filter lists are parameterized in the paramtm.ini file in the [BatchTools] section.

Country-specific sections are parameterized in the "language\patm_xx.ini" file in the section [BatchTools], "xx" stands for the 2 letters of the country code.



Prerequisite

I.

Filter selection

Sequence of operations

Select the tool management

"Filter lists" softkey

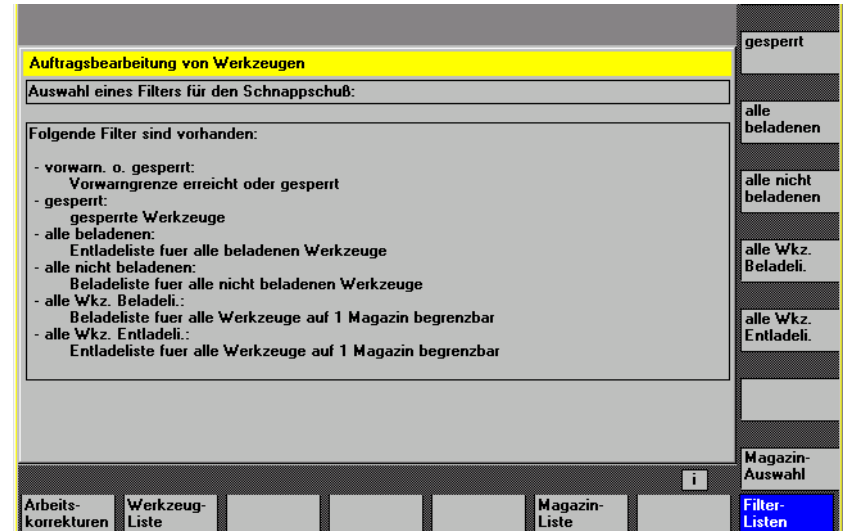

The screen provides up to 6 filters for selection by softkey, depending on the configuration in paramtm.ini.

Vertical softkeys

The softkey label "Filter 1- 6" is an example of how a label can be configured to represent the 6 filters that are permitted. Pressing the softkey starts determining the tools that match the criteria in the NC and jumps to a 2nd screen that displays the **hit list**. The filter produces a snapshot of the data. This data is **not** updated later.

You can use the filter definition to specify whether the filter always applies to the whole TOA or is restricted only to single magazines. You can use the "Magazine selection" softkey to select a particular magazine or "All magazines" for a restrictable filter.

When you switch from a magazine list to the filter lists and no current filter or batch processing is active in the TOA (you access the first screen "Filter selection"), the current magazine in the magazine list is taken as the preset value for restrictable filters.

If the situation is the same when coming from the tool list, the preset value is "All magazines".

Filter 1-6

Magazine selection

II.**Hit list
in the "Loading list" and
"Standard list" screens**

The "Hit list" screen has one of 2 configuration-dependent variants:

- Loading list with the functions "Load" and "Reactivate"
- Standard list with the functions "Reactivate", "Unload", "Delete", "In cabinet".



When filtering has started in screen 1 "Filter selection", the tools found in screen 2 "Hit list" are displayed in a list with one line per tool.

The data are a **snapshot** created at the time of filtering; it is **not updated later** when the data in the NC change.

**Selection
of tools**

No tool is selected for batch processing at the outset. By positioning the cursor and pressing the Select key, you can toggle the tool selection for batch processing. To change the tool selection for batch processing, you can use the "Select all" and "Deselect" softkeys.

Selected tools are represented in color and also indicated by a symbol in the 2nd column of the hit list on the display screen.

In the standard setting, a tool selected for batch processing is displayed with a checkbox that has been selected ( and ).

The color for "Cursor" and for "Selected for batch processing" is identical and corresponds to the general selection display.

When selection of the tools is completed, press the softkey to start the **batch function**.

Start batch function

"Load"

Auftragsbearbeitung von Werkzeugen												
Beladefliste fuer alle Werkzeuge auf 1 Magazin begrenzbar												
Werkzeuge: 63, ausgewählt: 6.												
Nr.	Sel.	WZ-Bez.	Duplo	Mag	Pla	A	F	G	M	V	E	O
31	<input type="checkbox"/>	Test18	1	0	0							
32	<input checked="" type="checkbox"/>	Test19	1	0	0							
33	<input checked="" type="checkbox"/>	Test20	1	0	0							
34	<input checked="" type="checkbox"/>	Test21	1	0	0							
35	<input type="checkbox"/>	Test22	1	0	0							
36	<input checked="" type="checkbox"/>	Test23	1	0	0							
37	<input checked="" type="checkbox"/>	Test24	1	0	0							
38	<input type="checkbox"/>	Test25	1	0	0							
39	<input type="checkbox"/>	Test26	1	0	0							
40	<input type="checkbox"/>	Test27	1	0	0							
41	<input checked="" type="checkbox"/>	Test28	1	0	0							
42	<input checked="" type="checkbox"/>	Test29	1	0	0							
43	<input type="checkbox"/>	Test30	1	0	0							
44	<input type="checkbox"/>	Test31	1	0	0							

Arbeitskorrekturen Werkzeug-Liste Magazin-Liste Filter-Listen

Vertical softkeys

All tools in the hit list are selected for batch processing.

The selection for batch processing is canceled for all tools in the hit list.

"Loading" is initiated as a batch command for the selected tools. You are prompted to enter the destination magazine and the load point in a dialog box.

"Reactivate" is initiated as a batch command for the selected tools. When reactivating a tool, the monitoring actual values and the wear are reset. You can use the INI file (entry `n_ReactivatePositioningMode`) to specify (for each filter) whether reactivation is to be carried out "always", "never", or "on request" with magazine positioning. Depending on the setting, the dialog box prompts for positioning and the load point as appropriate to the setting.

Select all

Cancel
selection

Load

Reactivate

"Unload"

Auftragsbearbeitung von Werkzeugen											
Entladeliste fuer alle Werkzeuge auf 1 Magazin begrenzbär											
Werkzeuge: 24, ausgewählt: 4.											
Nr.	Sel.	WZ-Bez.	Duplo	Mag	Pla	A	F	G	M	V	O
11	<input type="checkbox"/>	Test2	1	2	1						
12	<input type="checkbox"/>	Test6	1	2	2						
13	<input type="checkbox"/>	state_test1	1	2	3	F	G	M	V		
14	<input type="checkbox"/>	Test18	1	2	4						
15	<input type="checkbox"/>	Test22	1	2	5						
16	<input checked="" type="checkbox"/>	Test34	1	2	7						
17	<input type="checkbox"/>	Test42	1	2	9						
18	<input type="checkbox"/>	Test46	1	2	10						
19	<input checked="" type="checkbox"/>	Test48	1	3	10						
20	<input checked="" type="checkbox"/>	Test39	1	3	9						
21	<input checked="" type="checkbox"/>	Test9	1	3	2						
22	<input type="checkbox"/>	Test12	1	3	3						
23	<input checked="" type="checkbox"/>	Test27	1	3	6						
24	<input type="checkbox"/>	Test24	1	3	5						

Reactivate

"Delete" is initiated as a batch command for the selected tools. Loaded tools are unloaded prior to deletion. You are prompted to specify the unloading point in a dialog box.

Unload

"Unload" is initiated as a batch command for the selected tools. The tools are not deleted. You are prompted to specify the unloading point in a dialog box.

Relocate

"Relocation" is initiated as a batch command for the selected tools. A dialog box prompts you to enter the destination magazine where the tools are to be relocated. This magazine is the destination for all tools in this batch processing operation.

In the cabinet

The "In the cabinet" batch command is initiated for the selected tools. This function is similar to the "Delete" function; in addition, the tool data are saved in the tool cabinet database. Loaded tools are unloaded before being saved and deleted. In this case, the unloading point is queried interactively.

Update filter

The current filter and its magazine settings are used again and a new hit list produced. The tool selection for batch processing is canceled completely.

Recall "^"

The current number of hits is discarded and the 1st screen, "Filter selection", is displayed.





If batch processing has been started and the necessary entries have been made, the display switches to the 3rd screen, "Batch execution".

Batch execution

The screen shows the information relating to the batch execution as a whole and with respect to the individual tools. The user may halt, continue or cancel batch processing and monitor the results during and after batch processing.

Each tool is represented by a separate line in the list. The status of the tool is represented by the configured symbol in the 2nd column.

The following states are displayed by default:

- "Waiting to be machined": Gray field, 
- "Current tool in batch processing": yellow/blue arrow, 
- "Completed without errors": Green field with check mark, 
- "Completed with error(s)": Red field with "X", 

The status of the tool on which the cursor is placed is displayed in the form of a text, for example, any errors, load destination.

The state of the current tool in batch processing is displayed in the message line.

If the user does not move the cursor for a few seconds, the cursor is automatically placed on the current tool for batch processing when the next processing step has been completed.

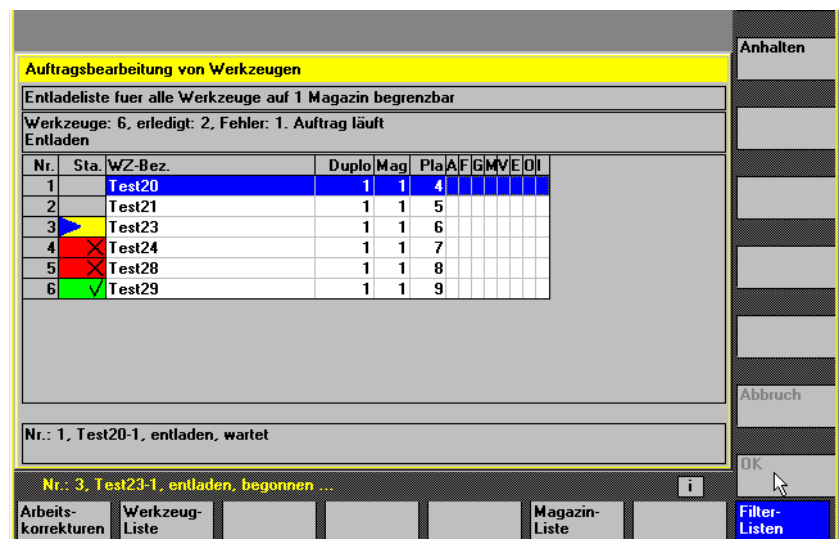

Auftragsbearbeitung von Werkzeugen

Anhalten

Entladeliste fuer alle Werkzeuge auf 1 Magazin begrenzt

Werkzeuge: 6, erledigt: 2, Fehler: 1. Auftrag läuft

Entladen

Nr.	Sta.	WZ-Bez.	Duplo	Mag	Pla	A	F	G	M	V	E	O	I
1		Test20	1	1	4								
2		Test21	1	1	5								
3		Test23	1	1	6								
4	X	Test24	1	1	7								
5	X	Test28	1	1	8								
6	✓	Test29	1	1	9								

Abbruch

Nr.: 1, Test20-1, entladen, wartet

Nr.: 3, Test23-1, entladen, begonnen ...

OK

Arbeitskorrekturen Werkzeugliste Magazinliste Filter-Listen

A rectangular button with the text "Stop" inside.**Vertical softkeys**

Batch processing is halted. Processing of the active element up to this point is either completed or canceled depending on the status and batch type.

This softkey can only be used while batch processing is in progress. Any batch processing operation that has been halted is continued. This softkey can only be used while batch processing is halted.

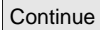
A rectangular button with the text "Continue" inside.A rectangular button with the text "Abort" inside.

Any batch processing operation that is halted is canceled. Non-completed jobs are discarded and display returns to the "Filter selection" screen.

This softkey can only be used while batch processing is halted.

A rectangular button with the text "OK" inside.

All information relating to completed, detailed batch operations is discarded and the display returns to the "Filter selection" screen:

This softkey can only be used when all detailed batch operations have been completed, irrespective of whether errors occurred or not.

Batch processing continues running in the background when you switch from your operator interface to other tool management screens or to other operating areas.

5.4 R parameters (calculation parameters)



Function

Parameters are read and written by programs.

In this operating area, parameters can be edited manually.

Edit/delete/find R parameters

The number of channel-specific R parameters is defined in a machine data element.

Range: R0 – R999 (dependent on machine data).

There are no gaps in the numbering within the range.



Sequence of operations

The "Channel-specific R parameters" window appears.

The channel-specific parameters are displayed.

The vertical softkey bar changes.

R param-
eters

You can page up and down using the "Page" keys.

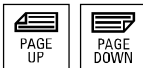

Edit parameters:

Position the cursor bar on the appropriate input field and enter the new values.

Delete parameters :

Displays a screen in which you can specify the R parameter range Rx to Ry to be deleted.

Delete
area

The entire R parameter range is deleted, i.e., all values are set to "0".

Delete
all

Inputs are discarded.

Abort

Deletes the entered R parameter range.

OK

Find parameters:

An input window for a parameter number appears when you press the "Find" softkey.

Enter the R parameter number you wish to find via the numeric keypad.

Find

When you press the "Input" key, the cursor is automatically positioned on this parameter if it exists.





Additional information

Input and deletion of parameters can be disabled via the keylock switch.

5.5 Setting data

5.5.1 Working area limitation



Function

The "Working area limitation" function can be used to limit the range within which a tool can traverse in all channel axes. These commands allow you to set up protection zones in the working area which are out of bounds for tool movements.



Sequence of operations

Setting
data

Press the "Setting data" softkey.
The vertical softkey bar changes.

Working
area limitat.

Press the "Working area limitation" softkey.
The "Working area limitation" window opens.

Edit the working area limitation:

Position the cursor on the desired field.
Enter the new values on the numeric keypad.
The upper or lower limit of the protection zone changes according to your input.

SELECT

Activate the appropriate working area limitation with the <SELECT> key.



In "MDA" and "Automatic" modes, the working area limitation is not activated according to setting data within the current NC program until a "WALIMON" command is set.



Additional information

The "Working area limitation" function can be disabled by means of the keylock switch.

5.5.2 JOG data



G function

Function

The feedrates must be specified in the unit determined by the G function.

- G94 Feedrate in mm (inch)/min
- G95 Revolutional feedrate in mm (inch)/rev

JOG feedrate

Feedrate value in the JOG mode

Continuous JOG

- JOG mode: The axis moves as long as the key is pressed.
- Continuous mode: The axis begins to move when the key is pressed once and continues until:
 - The key is pressed again.
 - NC Stop.
 - Reset.
 - Software/hardware limit switch.

Variable increment

Increment value for JOG variable increment

The following data are displayed only if a spindle is configured:

JOG spindle speed

Spindle speed in JOG mode

Spindle

JOG data for the master spindle:

- Spindle no.: Name of leading spindle
- Direction of rotation: Direction of rotation of leading spindle
- Spindle speed: Speed of the master spindle in JOG mode



Setting
data

Sequence of operations

Press the "Setting data" softkey.
The vertical softkey bar changes.

JOG
data

Press the "JOG data" softkey.
The "JOG data" window is opened.

Edit spindle data

Position the cursor bar on the appropriate input field and enter a new value.

or:

Select a new value using the <SELECT> key.





Additional information

The limit values for the maximum and minimum permissible values are defined in the machine data.

5.5.3 Spindle data



Max./min.

Function

The value entered for the spindle speed in the fields max./min. must be within the limit values defined in the machine data.

Programmed

Programmable upper speed limit (G96) for constant cutting speed.



Setting
data

Sequence of operations

Press the "Setting data" softkey.
The vertical softkey bar changes.

Spindle
data

Press the "Spindle data" softkey.
The "Spindle data limitation" window opens.

Edit spindle data

Position the cursor bar on the appropriate input field and enter a new value.

or:

Select a new value using the <SELECT> key.



Additional information

- The limit values for the maximum and minimum permissible values are defined in the machine data.
- The "Spindle data" function is displayed only if a spindle is configured.

5.5.4 Dry run feedrate for dry run operation DRY

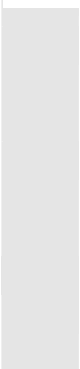
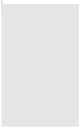

Setting
data

Feedrate
DRY

Function

The feedrate entered here is used in the active program instead of the programmed feedrate when the function "Dry run feedrate" (program control) is selected in "Automatic" mode.

Sequence of operations

Press the "Setting data" softkey.
The vertical softkey bar changes.

Press the "Feedrate DRY" softkey.
The "Dry run feedrate" window is opened.

Edit the dry run feedrate:
Enter a new value.

5.5.5 Starting angle for thread cutting



Function

For thread cutting, a starting position for the master spindle is displayed as the starting angle. A multiple thread can be cut by changing the angle when the thread cutting operation is repeated.

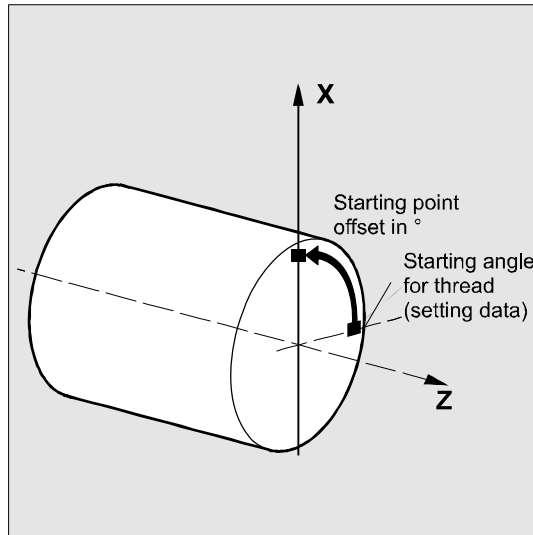

Setting
data

Starting
angle

Sequence of operations

Press the "Setting data" softkey.
The vertical softkey bar changes.

Edit starting angle:

Press the "Starting angle" softkey.
The "Starting angle for thread" window opens.

Enter a new value.

5.5.6 Miscellaneous setting data



Setting data

Misc.

General SD

Channel-specific SD

Axis-specific SD



PAGE UP

PAGE DOWN

Find

Find next

Function

All the setting data in the control are displayed in tabular form sorted according to general (i.e., NCK-specific), channel-specific and axis-specific setting data. The table contains both the setting data on the vertical softkeys such as working area limitation, Jog data etc., as well as special setting data such as software cam, oscillation, compensation, etc.

Sequence of operations

Press the "Setting data" softkey.
The vertical softkey bar changes.

Display setting data:

Press the "Misc." softkey.
The horizontal and vertical softkey bars change.

Select the type:

- The "General setting data (\$SN_)" window appears.
- The "Channel-specific setting data (\$SC_)" window appears.
- The "Axis-specific setting data (\$SA_)" window appears.

The current setting data of the corresponding type \$SN_, \$SC_ or \$SA_ are displayed.

Use the PageUp / PageDown keys to browse forward / backward.

Find setting data:

Enter the setting data you wish to find in the "Find" window (initial ID is sufficient).

If several setting data have the same initial identifier, you can display other setting data by selecting the "Find next" softkey.

Edit setting data:

Position the cursor bar on the appropriate input field and enter a new value.



Additional information

Data can be edited or not depending on the active access protection level.

5.5.7 Protection zones



Function

The "Protection zones" function allows you to protect various elements on the machine, your equipment or the machined workpiece against incorrect axis motions. You can view up to 10 programmed protection zones in levels G17, G18 and G19.

For further information about protection zones, please refer to /PGA/, Programming Guide Advanced.



Sequence of operations

Press the "Setting data" softkey.
The vertical softkey bar changes.

Setting
data

Press the "Protection zones" softkey.
The "Working area limitations and protection zones" window opens.
The vertical softkey bar changes again.

Protection
zones

Press the "Protection zone +" or "Protection zone -" softkey.
Up to 10 protection zones are displayed in succession.

Protection
zone +

Protection
zone -

Select the plane in which the relevant protection zone is located:

- Plane G17 (X,Y; Infeed direction Z)
- Plane G18 (Z,X; Infeed direction Y)
- Plane G19 (Y,Z; Infeed direction X)

G17

G18

G19

5.5.8 Electronic gear

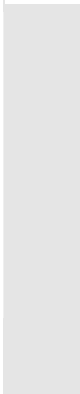

References

Function

The "electronic gear" function allows you to move a drive axis as a following axis in synchronism with up to five leading axes. The electronic gear is encoded via the following axis and has several lead axes, each of which applies a gear ratio. The ratio to the drive axis has a linear response and is defined as a coupling factor, numerator to denominator. A gear group is defined and activated during part program execution.

For further information, please see /PGA/, Programming Guide Advanced.



Setting data

Further >>>

Gearbox link

Following axis

Leading axes

- 1
- 2
- 3
- 4
- 5

Following axis ++

Following axis --

Sequence of operations

Press the "Setting data" softkey.
The vertical softkey bar changes.

Press the "Further >>>" softkey.
Two further softkeys appear, "Gearbox link" and "<<", for changing to the first softkey bar.

The vertical softkey bar changes to the "Electronic gear"

Coupling factor
Counter
instructions
Denominator

Synchronization position
Following axis **Leading axis**

:
:
:
:
:

Displays the position at which the teeth of the electronically simulated gear engage

You can use the softkeys "Following axis ++" and "Following axis --" to advance the following axis in both directions through the configured gear stages. The motion component of the following axis is derived from the coupling factors of the individual leading axes.

5.6 Zero/work offset

5.6.1 Function

Machine/ tool zero

The actual values are referred to the machine zero after a reference point approach. The machining program of the workpiece refers to the workpiece zero.

Machine zero and workpiece zero need not be identical. Depending on the type of workpiece and the way it is clamped, the distance between the machine zero and workpiece zero can vary. In part program processing this is compensated for by the work offset.

Work offset on a milling machine

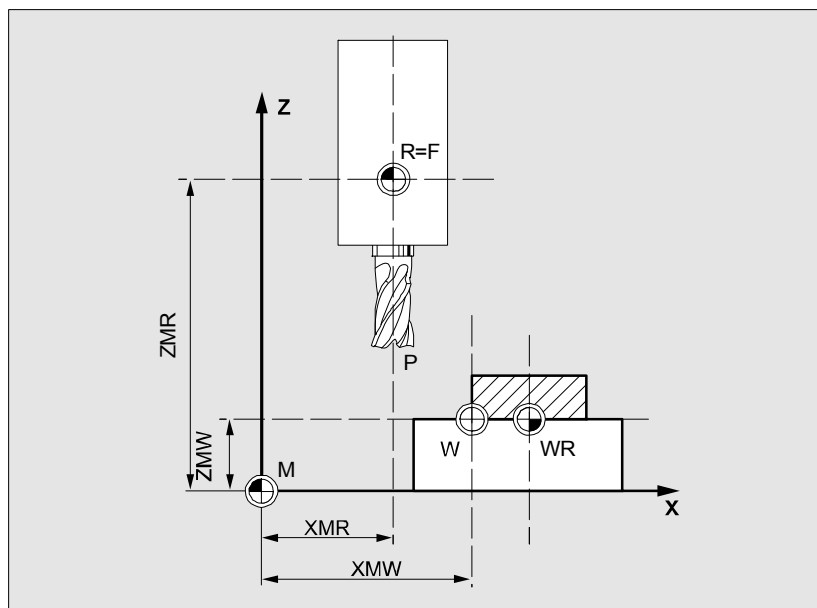

P	Tool setting point
W	Workpiece zero
F	Slide reference point
XMR, ZMR	Reference point coordinates
XMW, ZMW	Zero/work offset
M	Machine zero
R	Machine reference point
WR	Workpiece reference point

Effective WO

The work offset effective in an axis

$\$P_ACTFRAME=..$ results from the **sum** of the following zero point offsets:

Settable WO

You can activate a settable zero point offset in the part program you have called with G54 to G57 and other G functions or with \$P_IFRAME=..

Basic work offset (basic frame): displayed like a settable WO.

Programmable WO

You can use the programmable zero point offset \$P_PFRAME=.. to program an additional zero point offset for geometry and special axes in the part program you have called.

The values of the programmed work offsets are deleted with end of program or reset.

External WO

In addition to all the offsets which define the position of the workpiece zero, an external work offset can be overlaid by means of the handwheel (DRF offset) or from the PLC.

DRF offset

Differential Resolver Function: NC function which generates an incremental work offset in Automatic mode in conjunction with an electronic handwheel.

Frame

Frame is the conventional term for a geometrical expression that describes an arithmetic rule, such as translation or rotation.

Frames are used to describe the position of a destination coordinate system by specifying coordinates or angles starting from the current workpiece coordinate system.

Possible frames:

- Basis frame
- Settable frames (G54...G599)
- Programmable frames

References: /PG/, Programming Guide Advanced

Frame components**Frame components**

A frame can consist of the following arithmetic rules:

- Work offset, TRANS, ATRANS
- Rotation, ROT, AROT
- Scale, SCALE, ASCALE
- Mirroring, MIRROR, AMIRROR

In the part program, all work offsets can be deselected non-modally with G53.

Graphical display of work offset

See Subsection 4.2.3 Toggle between machine/workpiece coordinate system (MCS/WCS)



5.6.2 Edit the settable work offset (G54 ...)



Function

\$P_UIFR[]

This identifier can be used to edit a settable work offset in the program.

Coarse offset

The value of the coarse offset is defined for the relevant axis.

Fine offset

MD 9451: WRITE_ZOA_FINE_LIMIT specifies the data limits (absolute) for the fine work offset. The fine offset is displayed in the "Settable work offset" display.

Activation of WO via MD 18600: MM_FRAME_FINE_TRANS.

5.6.3 Global zero offset/frame



Function

In addition to the settable, programmable and external work offsets, up to eight **global** work offsets/frames (basic WO) can be defined. This allows offsets, scales and mirrors to be defined simultaneously for all channel and machine axes.

The global work offsets (NCU global frames) apply uniformly to **all** channels. They can be read and written from all channels. The activation is performed in the relevant channel.

**Basic TO
(total basic frame)**

In addition, eight channel-specific basic work offsets can be defined in each channel. The global and channel-specific frames are combined to produce a total basic frame (basic WO).



Machine manufacturer

Recommendation:

Use the 3rd basic offset onwards for your own applications. The 1st and 2nd basic offsets are reserved for setting the actual value and the external work offset.



References

With global frames there is no geometrical relationship between the axes. It is therefore not possible to perform rotations or program geometry axis identifiers.

The settable work offset and the basic work offset are represented in **one** table. You can edit the values in this table. You can switch between the values of the individual axes.

For **all** work offsets, you can display either the defined offsets (coarse and fine) or the specified rotations, scales and mirrors for each value.

/FB/ K2: Axis Types, Coordinate Systems, Frames

Rotation

The value of the rotation around the respective geometry axis (e.g. X, Y, Z) can be entered.

Rotation can only be programmed around geometry axes.

Scale

The scale factor can be defined for the respective axis.

Mirroring

Mirroring of the relevant axis around the coordinate zero can be activated and deactivated.

Work
offset

Press the "Work offset" softkey.
The vertical softkey bar changes.

Axes +

The display switches to the defined work offsets of the next axis.

Axes -

The display switches to the defined work offsets of the previous axis.

Offsets

Rotation
scl., mirr.

You can use these softkeys to change the display mode of the currently displayed work offsets.

The following takes place:

- Either the absolute offsets (coarse and fine) with reference to the coordinate axes
- Or a list of individual values, split into components for rotation, scale and mirroring.

You can select and, if necessary, edit the individual values of the work offsets in both display modes.

Basic WO

All defined basic work offsets (global and channel-specific) are displayed in a table.

The display mode can be changed by softkey (see above).

You can edit the values directly in the table.

Rotations are not possible with global frames, since no geometrical relationship exists between the axes in this case.

Settable
WO

All defined settable work offsets are displayed in a table and can be edited if necessary (select and edit).

Additional information

- Changes to the work offsets are updated immediately on input. The entries no longer have to be confirmed separately.
- If not all work offsets are displayed in the tables, you can scroll through the table with the corresponding keys.

Display and edit the active work offset

Active WO
+ offset

Press the "Active WO + offset" horizontal softkey.

The vertical softkey bar changes.

Axes +

Displays the active work offset of the next axis.

Axes -

Displays the active work offset of the previous axis.

Offsets

Rotation
scl., mirr.

You can use these softkeys to change the display mode of the currently displayed work offsets.

Change
active WO

A table of currently active work offsets and the offsets of the selected axis are displayed. You can select and, if necessary, edit the individual values in the table.

The following values are displayed:

- Global basic WO; Coarse and fine (if defined)
- Channel-specific basic WO; Coarse and fine (if defined)
- Settable WO; Coarse and fine (G57)
- Programmable WO; G58 (TRANS), G59 (ATRANS)
- T number and D number of active tool
- G17 (geometry, wear, base).

5.6.4 Displaying an active settable work offset



Work offset Go to...

Active settable WO



References

Overview

Function

The active settable work offsets (selected from part program or MDA) can be displayed.

Sequence of operations

Press the "Work offset" and "Go to ..." softkeys. The vertical softkey bar changes.

The "Active settable WO" window opens. You can edit these values if necessary.

/PGA/, Programming Guide Advanced

An overview shows all values of the active work offset and offsets (no changes possible) including a selection of tool data (T number, D number, etc.). The basic work offset and the settable work offset are displayed as the sum.

Parameter	CHAN1	Auto	MPF0			
Channel reset		Program aborted				
		ROV SBL1			Axes +	
Overview of active work offsets and compensations						
Mach. axis		X1[mm]	Y1[mm]	Z1[mm]	Axes -	
Actual value	Machine (MCS)	0.000	0.000	0.000		
Overlaid movement		0.000	0.000	0.000		
DRF offset		0.000	0.000	0.000		
External WO		0.000	0.000	0.000		
Total WO	Coarse	399.000	100.000	0.000	Details	
	Fine	1.000	0.000	0.000		
	Rotation[deg]	0.000	0.000	0.000		
	Scale	1.000	1.000	1.000		
	Mirror	<input type="checkbox"/>	<input type="checkbox"/>	<input type="checkbox"/>		
Act. tool	T no.	34	D no. 2	Plane G17	Overview	
	Lengths					
	Radius					
Actual value	Work (WCS)	-400.000	-100.000	0.000		
Geo. axis		X	Y	Z		
Tool compens.	R variables	Setting data	Work offset	User data	Active WO + compens.	

The following values are displayed:

- Actual value of MCS and settable zero system
- Overlaid movements
- DRF offsets
- Zero offsets external
- Sum of the work offsets; calculated from the basic, settable and programmable work offsets (corresponds to the "Editing the active..." table)
- Data of the active tool (T number, D number with reference to the plane G17, lengths, radius)
- WCS actual value.

Additional information

The active work offset must be changed only when the NC program is stopped. Changes are updated immediately. The work offset values in the display are updated cyclically.

5.6.5 Displaying an active programmable work offset



Function

The active, selected programmable work offsets (from part program or MDI) can be displayed.

Values cannot be edited in this display.



Sequence of operations

Press the "Work offset" and "Go to ..." softkeys.
The vertical softkey bar changes.

The "Active progr. WO" window opens.

Work
offset

Go to...

Active
progr. WO

5.6.6 Displaying an active external work offset



Function

The active, external work offsets can be displayed.
Values cannot be edited in this display.



Sequence of operations

Press the "Work offset" and "Go to ..." softkeys.
The vertical softkey bar changes.

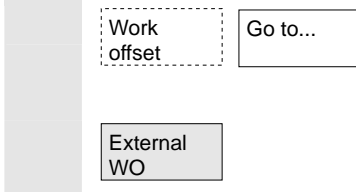

The "External WO" window is opened.

5.6.7 Display the sum of the active work offsets



Function

The sum of the active work offsets from the part program can be displayed.
Values cannot be edited in this display.



Sequence of operations

Press the "Work offset" and "Go to ..." softkeys.
The vertical softkey bar changes.

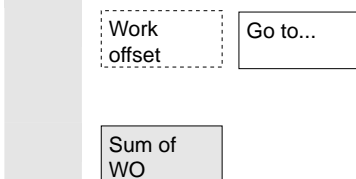

The "Sum of WO" window is opened.

The sum of work offsets is calculated in the following way:
Sum WO = active settable WO + active programmable WO



The values can be edited only in the "Settable work offsets" menu.
(see Section "Settable work offsets" menu)

5.6.8 Activate active work offset and basic frame immediately



Function

Machine data MD \$MM_ACTIVATE_SEL_USER_DATA can be set to ensure that the work offset and basic frame are made immediately effective when the part program is in the "Reset" state. This also occurs if the part program was first switched to JOG status. If the channel is in the "Reset" state, active work offset and basic frame are not activated until the part program is continued.

Additional information

When the function is used in the Reset state, MD \$MC_RESET_MODE_MASK must be set such that the settable work offset or basic frame is not reset when the program switches to Reset.

Machine manufacturer

see the machine manufacturer's information.

/FB/ K2: Axes, coordinate systems, frames

Danger

The offset is applied the next time the part program is started.

5.6.9 Actual value display: Settable zero system, SZS



Function

You can make a setting in the MD to define whether

- The position of the workpiece coordinate system, WCS (= programmed position, corresponds to default setting) or
- The holding position of the active tool relative to the workpiece zero (settable zero system = SZS) must be shown in the actual-value display.

References

Commissioning Manual HMI-Advanced (IM4),
Chapter Zero/work offset

5.7 Define user data

5.7.1 Define variables (GUD, PUD, LUD)



Function

User data (UD) can be defined by means of a variety of variables:

- GUD - global variables which are valid in all programs.
- LUD - local variables which are valid only in the program or subprogram in which they have been defined.
- PUD – global program variables.
Local variables (LUD) defined in the main program are turned into global program variables (PUD) by a setting in a machine data.
PUD variables are valid on all subprogram levels, where they can also be written and read.

The user data (GUD) can be defined for HMI in the Services operating area (in the Definitions directory); reinitialization is not necessary.

The following applies:

- Definition files that are on the hard disk are not active.
- Files can be transferred to NC and activated using the "Activate" softkey.

The user memory must be configured to a large enough size before the GUD definition file is loaded to the control. All relevant machine data have GUD as a component of their name.

The display of global user data (GUD) can be locked by means of the keylock switch or a password.

For more information on how to protect global user data in the part program, please refer to

/PGA/, Programming Guide Advanced
Section: File and Program Management.



5.7.2 Editing/finding user data



User data

Global user data

Chan.-spec. user

Program user data



GUD +

GUD -

GUD:

Sequence of operations

Press the "User data" softkey.
The "Global user data" window is displayed.
The vertical softkey bar changes.

You can toggle between windows

- "Global user data" (GUD)
- "Channel-specific user data" and
- "Program user data"

Program-global variables (PUD) and local variables (LUD) are displayed.

You can scroll up and down in the list using the "Page" keys.

Edit user data

Position the cursor on the user data that you wish to edit and enter a new value.

New values are automatically accepted.

Searching user data

Press the "GUD +" and "GUD -" softkeys to scroll through user data from GUD 1 to GUD 9.

The "Select global user data" window is opened. The following values are permissible:

- 1 = SGUD (Siemens)
- 2 = MGUD (machine manufacturer)
- 3 = UGUD (machine user)
- 4 ... 9 = GD4... GD9 (additional, e.g., grinding cycles, etc.)

The selected data are displayed in the "Global user data" window.

Additional information

Up to 200 characters can be entered/displayed for GUD of type String.

Find

Press the "Find" softkey.

The "Find user data" dialog window appears on the screen.

The data name or a character string within the name can be entered as the search target.

The cursor must be positioned on the user data to be found.

Find
next

The next user data with the initial identifier searched for is displayed.

User data of types `AXIS` and `FRAME` are not displayed.

Only those local user data that still exist in the execution chain of the control are displayed.

The list of local user data for the display window is updated every time "NC Stop" is actuated. The data values are updated continuously.

Before global user data definitions can be made operative in the control, it may be necessary to set machine data.

Additional information

How to define and activate user data is described in chapter Service operating area

5.7.3 Activate user data (GUD)



Response

OK

Abort

Function

Create a definition file for user data:

- In the "Services" operating area using the "Manage data" softkey
- in the "Definitions" directory

If a definition file is edited in the NC, when exiting the Editor you are prompted whether the definitions are to be activated.

Example:

"Do you want to activate the definitions from file GUD7.DEF?"

"OK" → A query is displayed asking if the currently active data should be saved. "Should the previous definition data be retained?"

"OK" → The GUD blocks of the definition file to be edited are saved, the new definitions are activated and the saved data are imported again.

"Abort" → The new definitions are activated, the old data are lost.

"Abort" → The changes in the definition file are discarded, the associated data block is not changed.

Unload

If a definition file is unloaded, the associated data block is deleted after a query is displayed.

Activate

If a definition file is loaded, a prompt is displayed asking whether to activate the file or retain the data. If you do not activate, the file is not loaded.

If the cursor is positioned on a loaded definition file, the softkey labeling changes from "Load" to "Activate" to activate the definitions. If you select "Activate", another prompt is displayed asking whether you want to retain the data.



Manage
data

New



References

Data is only saved for variable definition files, not for macros.

Additional information

If there is insufficient memory space available to activate the definition file, then the file must be unloaded. After the memory size has been adjusted, the file must be loaded from the NC to the HMI and back again to the NC. The files are then activated.

Create a definitions directory

The definition files that the user can access are created and edited under the definitions directory `_N_DEF_DIR`:

- `SACCESS.DEF (_N_SACCESS_DEF)`
- `MACCESS.DEF (_N_MACCESS_DEF)`
- `UACCESS.DEF (_N_UACCESS_DEF)`

They do not need to be activated but are loaded to the passive file system of the NCK as follows:

Press the "Manage data" softkey.

The horizontal and vertical softkey bars change.

Load the definitions directory in the HMI without modifying the existing access authorization.

Change write access

The data imported during the series commissioning are created and edited in the definitions directory `_N_DEF_DIR`:

- `SACCESS.DEF (_N_SACCESS_DEF)`
- `MACCESS.DEF (_N_MACCESS_DEF)`
- `UACCESS.DEF (_N_UACCESS_DEF)`

They do not need to be activated but are loaded to the passive file system of the NCK as follows:

Definition and creation of user data

See /PGA/, Programming Guide Advanced

5.8 Display system variables



Function

System variables can be used for a wide range of different functions (e.g. as variables or in synchronized actions).

The following options are available:

- View variables in a defined display (e.g., as a value or graphic characteristic) or
 - Variable views:Manage
 - Display variables of a view
 - Define variable views
- Generate a log of the response of variables during a program run
 - Define logs
 - Start a log
 - Manage a log
 - Display log



Sequence of operations

The “System variable views” screen appears.

System
variable

Views of system variables		View 1 *
Actual values		View 2 *
\$AA_IW[1]	10000.144	View 3 *
\$AA_IW[2]	20089.000	View 4 *
Calculation parameters		More views
\$R[0]	100.0	Edit view
		Select view
		Variable log

Edit
view

Select
view

* The names of these softkeys can be customized.

This softkey opens a window in which views can be created or edited.

With "Select view", a dialog is started in which the user can select individual views or a file with several views.

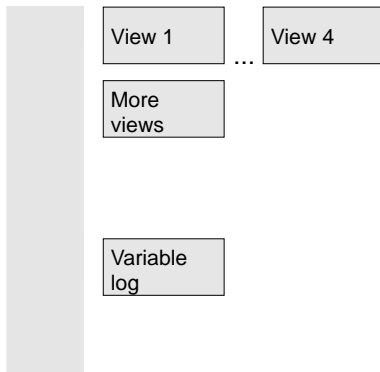

The names of the views of a file are assigned to the "View 1" to "More views" vertical softkeys. If a file contains more than five views, you can press the "More views" softkey to select the views stored in the file in blocks of four.

The "Logging system variables" display is selected with the "Variable log" softkey.

5.8.1 Creating variable views



Function

You can compile your own variable views.

The display of variables can be edited:

- Layout (e.g., 2 columns with 2 rows) or
- Properties (e.g. name, display type, input limits).



Sequence of operations

The "Edit view" softkey changes to edit mode.

With "Insert variable", a dialog box is opened in which the required system variable can be selected from a list using the cursor and the "Edit" key. The full name of the variable appears in the info line.

It is included in a new line or column in the view with the "Input" key. The variable is inserted after the cursor position.

Confirm your input with OK.

By selecting the "Insert user variable" softkey, it is possible to access any existing user data by the same method. These user variables are available in the respective GUD block even when no GUD definition files are activated. The NCK does not assign a \$ as initial character.

The "Properties" softkey opens a dialog box in which the text displayed with a variable can be edited.

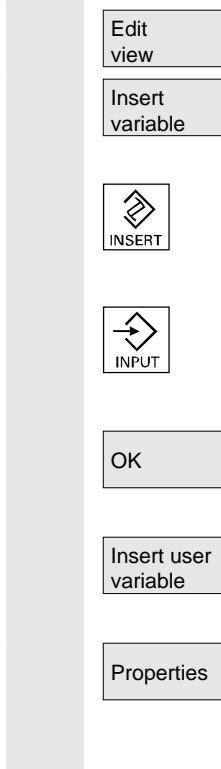

The following properties can be edited:

- **Identifier** Assign variable name,
- **Displayed OPI variable** Assign a different variable,
- **Variable type** REAL Number of places after the decimal point:

CHAR		
STRING	Text length:	
BOOL		
VARIANT	Selection for format	
INT	Format: Decimal	B, W, D, BU, WU, DU
	Binary	B, W, D
	Hex	BU, WU, DU
- **Access levels** 0 to 7 are possible
- **Limit value check** Min + Max only Min or only Max or list entries
- **Text:**

User response line text	Long text on right next to header
Graphic text	Text on left next to I/O field
Text for units	Text on right next to I/O field
Screen text	Displayed variable text
- Text orientation and text positioning,
(when 0 values are entered, the field is automatically set to default values.)
- Text size (character size) and display type
- **Path for help screen file**

Path for help text file	
Index in the help text file	Search text



Delete
variable

Delete
all

You can display additional information about the variables (variable description) by pressing the "info key".

If you want to remove a system or user variable from a view, select it and press the "Delete variable" softkey.

You can delete the entire contents of the display with "Delete all", which does not affect a stored view on which the screen contents are based.

5.8.2 Managing variable views

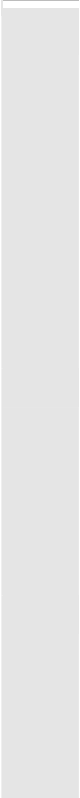

Edit
view

Manage
views

New
file

File
contents

Delete
file

File
contents

Display
view

New
view

Delete
view

Save
view

Function

The views you create are stored and managed in file form.

Sequence of operations

With the "Edit view" and "Manage views" softkeys you can open a window in which files and views can be

- created
- displayed and
- deleted.

The "File contents" softkey takes you to another window in which the views of the previously selected file are displayed. With the "Display view" softkey you exit the dialog box and the previously selected view is displayed on the "System variable views" screen.

These softkeys also enable you to create views,

delete views and

save the currently displayed view under a selected name.

5.8.3 Logging system variables



Function

When variables are used in synchronized actions, it may be necessary to evaluate and log the status of actions in the interpolation cycle. This is done by writing the values selected for a log definition to a log file of defined size in the specified cycle.

Recording of synchronized action variables can be limited to the event with identification number 1.

This event records variables in the IPO cycle or multiples thereof.

- A maximum of 6 variable contents can be recorded simultaneously in the log file.
- Size for memory depth: Values between 3 and 50 KB.

The HMI interprets the contents of the log file and displays them in graphic form.



Sequence of operations

The "System variable views" appears.

The "Variable log" softkey opens the screen with the heading "Log system variables".

The "Insert variable" softkey opens a dialog box in which the system variable to be recorded can be selected.

The "Insert user variable" softkey opens a dialog box in which the existing user variable can be selected.

The variable name in the higher-level window in the current recording list appears after confirmation with "OK".

If the list already contains 6 entries, the entry on which the cursor is positioned is overwritten.

Whenever you create a log, you must first initialize the logging function in the NC by pressing the "Initial. log" button.

You are informed when initialization is complete in the bottom left-hand corner of the display with the message "Logging initialized - You can now start".

System
variable

Variable
log

Insert
variable

Insert user
variable

OK

Initial.
log

Start log or
\$A_PROTO=1
Stop log or
\$A_PROTO=0

Manage
log

Graphic
log

Set marker

You can start logging by pressing the "Start log" button or with the system variable \$A_PROTO=1 in the part program.

It is stopped with the "Stop log" button or the system variable \$A_PROTO=0.

After stopping, the log memory is automatically loaded to a file.

The button "Manage log" calls up a dialog box in which you can

- Save a new log to a file or
- Reselect a log that is already saved.

With the "Graphic log" button you call up a window in which the changeover time of the variables is displayed as a curve.

Measuring times are output along the horizontal axis and variable contents are output along the vertical axis. A graphic log window may contain several curves, the appropriate variable name is displayed at the top left of each curve.

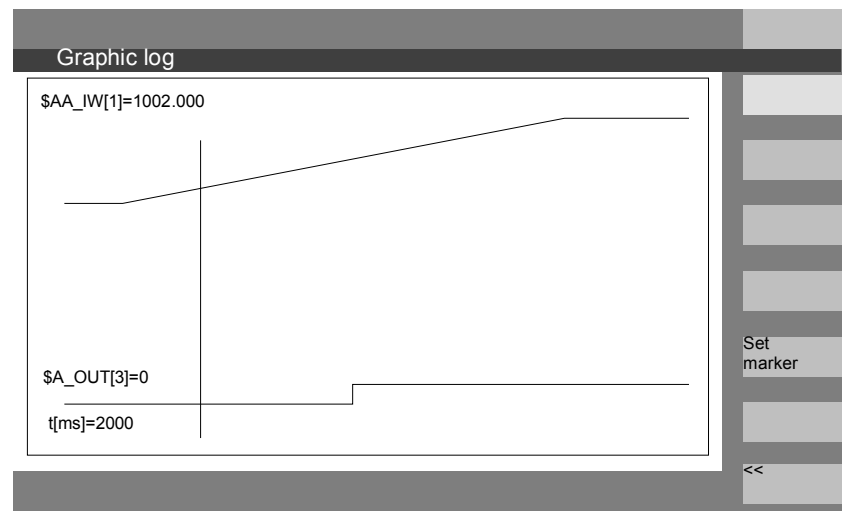

The "Graphic log" display provides you with a zoom function in which a section that you have already selected can be expanded to cover the entire display surface.

With the "Set marker" softkey a vertical cursor line appears, which is moved with the cursor left and cursor right keys.

The softkey text then changes from "Set marker" to "Set marker2" and from "Set marker2" to "Expand".

Variable values marked by the cursor line are displayed on the left of the display.

You do not need to normalize the display in any way, normalization values are calculated automatically. The characteristic is automatically normalized to values between minimum and maximum. Binary signals are represented in expanded form.

"Program" operating area

6.1	Program types.....	6-253
6.1.1	Part program	6-253
6.1.2	Subprogram	6-253
6.1.3	Workpiece	6-253
6.1.4	Cycles	6-253
6.1.5	Storing programs	6-253
6.1.6	Templates	6-254
6.2	Main screen program	6-256
6.3	Edit programs in the standard ASCII Editor	6-258
6.3.1	Undo and redo in the standard ASCII editor	6-260
6.3.2	Additional optional editors	6-261
6.3.3	Selective program protection *RO*	6-261
6.4	Structured step sequence display (option)	6-263
6.5	Multi-channel step sequence programming (option).....	6-267
6.5.1	Multi-channel workpiece program views	6-270
6.5.2	Activating timing	6-276
6.5.3	Activating simulation	6-277
6.6	Multiple editor (option)	6-281
6.6.1	Operator/display functions in the ASCII full views	6-281
6.6.2	Alignment of the channels/MPFs to be displayed.....	6-285
6.7	Free contour programming	6-287
6.7.1	Programming a contour	6-288
6.7.2	Undercuts for turning technology	6-293
6.7.3	Parameterizing contour elements	6-296
6.7.4	Graphically displaying the contour	6-298
6.7.5	Symmetrical contours with milling technology	6-299
6.7.6	Specifying contour elements in polar coordinates, closing the contour.....	6-302
6.7.7	Support for contour programming	6-307
6.7.8	Parameter description of the contour elements straight line/circle	6-308
6.7.9	Programming examples for freely programming a contour	6-309
6.7.10	Cycle support	6-313
6.8	Program simulation	6-314
6.8.1	Using the simulation function	6-316
6.8.2	Simulation settings	6-325
6.8.3	Setting downtimes.....	6-331
6.8.4	Display and colors.....	6-332
6.8.5	Section-by-section simulation	6-333
6.8.6	Quick display in the simulation for mold making.....	6-334
6.8.7	Simulation with external network drive	6-336
6.8.8	Simulation for orientable toolholder	6-337
6.9	Managing programs	6-337

6.9.1	New workpiece/part program	6-339
6.9.2	Create programs/data in a workpiece directory	6-341
6.9.3	Saving setup data.....	6-342
6.9.4	Selecting a program to be executed	6-343
6.9.5	Loading/unloading a program	6-346
6.9.6	Manage programs	6-347
6.9.7	Copying/inserting.....	6-348
6.9.8	Deleting	6-351
6.9.9	Renaming	6-352
6.9.10	Enabling	6-353
6.9.11	Protocol	6-354
6.10	Accessing an external network drive/computer	6-355

6.1 Program types

6.1.1 Part program



A part program consists of a sequence of instructions to the NC control. In its entirety, this sequence affects the production of a specific workpiece or a particular machining process on a given blank.

6.1.2 Subprogram



A subprogram is a sequence of instructions in a part program which can be called repeatedly with different defining parameters. Cycles are a type of subprogram.

6.1.3 Workpiece

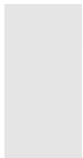

- A workpiece is a part to be produced or machined by the machine tool or from the HMI perspective is to be produced or machined. In the HMI, a workpiece is a directory in which programs and other data for machining a particular workpiece are stored.

6.1.4 Cycles



Cycles are subprograms for the execution of a recurring machining process on the workpiece.

6.1.5 Storing programs



Programs can be saved in the NC memory or on hard disk. The currently available memory space is displayed in the user response line.

Cycles can also be stored in the NC Flash File System.

6.1.6 Templates

Templates are objects that can be used for creating new workpieces, part programs, subprograms, job lists, work offsets, etc. and can be edited and customized to suit the task at hand.

With HMI Advanced, templates for job lists are stored in the file system by default. Specific user templates must first be created in template directories. This allows you to access them when creating new objects. Templates can be designed in different languages and named to allow easy language-specific access to them. If you create a template with a wildcard in the name, the current workpiece name will be inserted into the name when the template is activated.

There is no difference between **creating templates** and creating workpieces, part programs, subprograms, job lists, work offsets, etc. You can use the administration functions and naming conventions to enter objects you want to use as templates in the template directory. Templates can be created from the Services operating area directly in the required directories.

Existing templates are offered for selection when you create new objects.

Naming conventions for templates

TEMPL

If this string is assigned as part of the template name, it is replaced by the workpiece name when the template is activated. The template is not copied if the name exceeds 24 characters after replacement.

_XX

If the template name terminates in **_XX** (XX stands for the language code, e.g., **_GR** for German), only the objects are offered from the template directory where the current language matches the language code in the template name. Templates for different languages can therefore be stored together in the template directory.

1_1

If the template name starts with **1_1**, the template is proposed for standard configuration.

M_N

If the template name starts with **M_N**, the template is proposed for M:N system configurations (netnames.ini is configured).

1_1 or **M_N** can be **combined** with **_XX**.



Directories for templates

Additional information

Language-specific templates are given priority over non-language-specific templates with the same core name component. Therefore, you can create a template which can be used for all languages for which no language-specific variants are available.

The Services operating area contains the following subdirectories under Templates:

Users Empty when shipped

Vendor Empty when shipped

Siemens Standard job lists provided when shipped

Templates Empty when shipped

If the **Templates** subdirectory for this data type is not empty when creating a new data type, you can enter "No template" to access the templates in the user, manufacturer and Siemens directories.

User, manufacturer and Siemens templates are available for individual file types under:

Commissioning → HMI → System settings → Templates

The activation differs according to:

- Job lists
- Initialization programs
- Part programs/subprograms
-

In the **Templates** directory, you can store:

- Individual templates for various data types and
- **Complete workpieces** as templates in a subdirectory. The full workpiece templates are offered for selection when data type WPD is newly created. If selected, **all** components belonging to the template are copied to the new workpiece in accordance with the above naming conventions. With other data types only the selected template is used.

Create templates

In the **Services** operating area select the directory for which you are authorized.

Templates/Users

/Manufacturer

/Siemens

/Templates

New...

Define the name, data type and - if required - template.

Confirm with OK.

Use the editor to process the created template.

Save templates

You can use the administration functions to copy and paste template objects to the directories and use the above mentioned naming conventions to rename the templates e.g., for specific languages or workpiece names.

You can save existing templates under Services "Data out" or read saved templates back in with "Data in".

6.2 Main screen program

The program's main screen contains a complete overview of all workpiece and program directories.

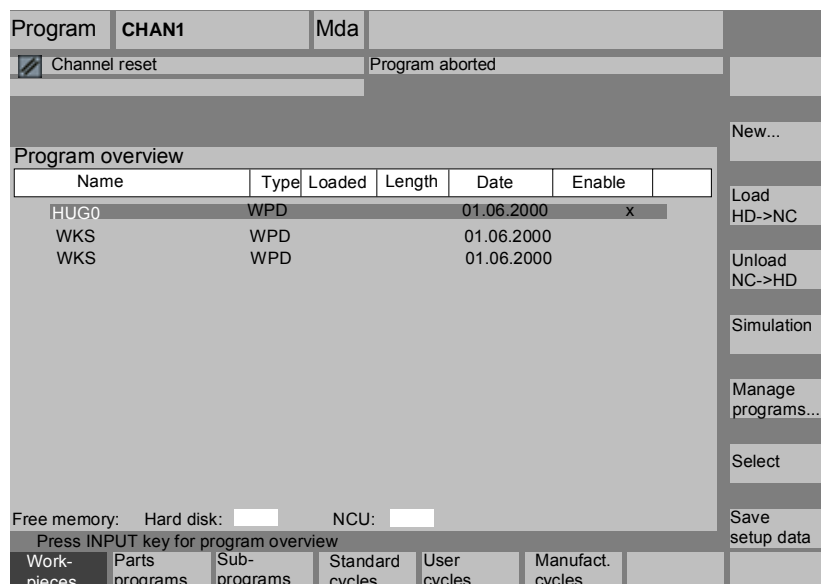

Horizontal softkeys

Part programs

An overview of all part programs (main programs) stored in the selected directory is displayed.

Sub-programs

An overview of all subprograms stored in the selected directory is displayed. Subprograms are processed in the same way as described for "Process main programs".

<External drive>

If external drives are configured, up to three softkeys can be found in the softkey bar with the configured drive/computer designation.



Select the "Standard cycles" softkey to display a list of the cycles that Siemens has added. See softkey definitions.



Select the "User cycles" softkey to display a list of the user cycles that you have added.



Select the "Manufacturer cycles" softkey to display a list of the cycles that have been integrated by the manufacturer.



After pressing the "ETC" key and the "Log" softkey, you can display the log of error messages for errors which occurred during "Copy", "Rename", "Load", etc.

Softkey definitions

If external network drives are configured for the control, the softkeys for these drives replace the "Standard cycles", "User cycles" and "Manufacturer cycles" softkeys. If you have configured four softkeys, the fourth one is displayed in the More bar when you press the "ETC" key. If network drives are configured, the "Standard cycles", "User cycles" and "Manufacturer cycles" softkeys also appear in the More bar after pressing the "ETC" key.

Vertical softkeys



Creates a new file for a workpiece/part program.

If activated templates exist for the created data type, they are proposed. If they are accepted, the copy of the template becomes the created object.



The highlighted program (or programs) is (are) loaded from the hard disk to the NC memory.



The highlighted program is unloaded from the NC memory to the hard disk.



With the function "Simulation" you can display axis movements graphically and simulate the results of machining on the screen.

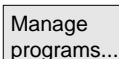

With the "Manage programs" softkey you can manage the functions "New", "Copy", "Insert", "Delete", "Rename" and "Enable".

 Selection

The name of the selected workpiece is displayed in the top of screen in the "Program name" field. The program is also loaded and selected for processing.

 <<

When you branch to a workpiece, the "<<" softkey automatically appears to allow you to return to the main menu.

6.3 Edit programs in the standard ASCII Editor



Function

The default editor for creating and editing part programs or other text files is the standard ASCII editor. This allows users to edit part programs using individual instructions: G codes, keywords, etc.

The version with two windows displaying two sets of program instructions side-by-side is referred to as the "Dual ASCII editor" (dual editor).

- The **standard ASCII** editor displays the characters that can be entered via the keys on the operator panel.
- A part program opened by the editor cannot be simultaneously started in the NC (enable is canceled); an alarm (14011) is indicated in this case. If the control is switched off while the editor is open, the enable might have to be set manually.
- When you exit the editor after editing cycles in the NC and if these cycles are also stored in the Flash File System, then an activity symbol (fan symbol) is displayed while the data is being copied into the Flash File System.

See also:

→ Subsection 6.1.5 Storing programs

→ Chapter 2 General operating sequences



Find/
Go to...

View
subprogr.

Dual ASCII editor

If you are positioned on a subprogram call in the **ASCII editor**, this program is loaded to the second editor when you press the "View subprogram" softkey.

This function is only available in the ASCII editor.



Find/
Go to...

Synchron.
WAIT

Synchronized view in the dual ASCII editor

You can view instruction groups in the **ASCII editor**. Position the cursor on a WAIT marker instruction in one of the two ASCII editors.

Press the "Synchron. WAIT markers" softkey. This string is sought in the second editor and displayed at the same height in the window as the cursor in the first editor. The focus remains in the first editor.

If no WAIT marker instruction is found together with its brackets, the next WAIT marker instruction is displayed in the adjacent window regardless of the brackets.

Programm	CHAN1	AUTO	MPF0
Kanal	RESET		
Programm	abgebrochen		ROV SBL1
120120 ↓ Alarmtexte: Datei E:\dh\mb.dir\aluc_GR.com nicht gefunden			
		Editor	198
N210	D0 G53 Z250. ¶	¶	
¶		¶	
;	#0 80VORPLANEN¶	¶	
N220	MSG("VORPLANEN") ¶	N1600	MSG("AUSSEN 1.FERTIGDREHE
N230	; (TCN_NN) ¶	N1610	; (TCN_NN) ¶
:240	T2 D1 M7 ;PLANLA ¶	:1620	TS D1 M7 ;ECKKOP35 ¶
WAITM(1,1,2)¶		WAITM(1,1,2)¶	
N250	S546 M4 ¶	N1630	S2307 M4 ¶
N260	G0 G64 Z12. ¶	N1640	G0 G64 Z20. ¶
N270	X134. ¶	N1650	Z2. ¶
N280	Z0.1 ¶	N1660	X40. ¶
;(V const. ein)¶		;(V const. ein)¶	
N290	G96 S230 ¶	N1670	G96 S300 ¶
N300	G1 X132. F0.32 ¶	N1680	G1 G42 X40. Z0. F0.1 ¶
N310	X23.4 ¶	N1690	X44. ¶
N320	Z2.1 ¶	N1700	X77. F0.16 ¶
N330	G0 X27.4 Z4.1 ¶	N1710	X80. Z-1.5 F0.1 ¶

6.3.1 Undo and redo in the standard ASCII editor



Edit

Function

When editing a part program or a text file, you can undo complete blocks in the editor:

- Press "Ctrl" and "Z" for "Undo" (reset)
- Press "Ctrl" and "Y" for "Redo" (reactivate)

Once you undo a series of blocks, you can redo the same number of blocks. Both functions only apply to programs that are not loaded.



"Ctrl" + "Z"

Sequence of operations

Press the key combination "Ctrl" + "Z". All changes in the entire block are undone. Repeat the key combination to undo the previous change. The "CR" symbol at the end of the block is also considered. This procedure can be repeated until the last change or the set number of changes has been reached.

"Ctrl" + "Y"

Press the key combination "Ctrl" + "Y".

The last changes undone in the editor are redone. This procedure can be repeated until the last change is redone or the set number of maximum changes has been reached.



The default number is 10 steps; this setting can be changed. Setting the number to zero deactivates the function.



References

Commissioning Manual HMI-Advanced (IM4)

6.3.2 Additional optional editors



Step editor display (option) As an option, the **single step sequence** display can be used with extended functions. These extended functions allow you to process technology-oriented program steps which are stored and displayed with special icons in the editor for each step type to enable easier recognition. The steps must be defined in the SEDITOR.INI file:

- Groups of individual instructions:
G codes, keywords, etc.
- Synchronization instructions (e.g. WAITM)
- Cycles
- Contour definitions

Advantages:

- Improved readability of programs
- Operations based on steps (copy, insert, delete etc.)
- Recompile from step to DIN code, contour definition and cycle display available
- Step sequence displays form the basis for the multi-channel step sequence programming

See Section 6.7 Structured display in the step editor (option)

Multi-channel step sequence programming (option)

Multi-channel step sequence programming is available as an option and offers the following features:

- Simultaneous display of several programs for a workpiece in multiple channels
- Optional fixed step lengths or time proportional display of step lengths in the channels
- Display of processing duration for steps and waiting time at synchronization points

See Section 6.8 Multi-channel step sequence programming (option)

6.3.3 Selective program protection *RO*



Function

In programs written with program templates or when using the programming support functions, certain machine-specific code lines may be protected against changes.

A read-only identifier ("*RO*") is tagged onto the code program blocks as a comment.

The user can always identify protected program sections by the "Read Only" identifier (";*RO*"). Any attempt to change a program part protected by the read-only identifier is denied with the message "Block cannot be written".

Example

The ASCII editor recognizes these blocks, hides them or displays them in the read-only text color (gray), and prevents changes to these blocks.

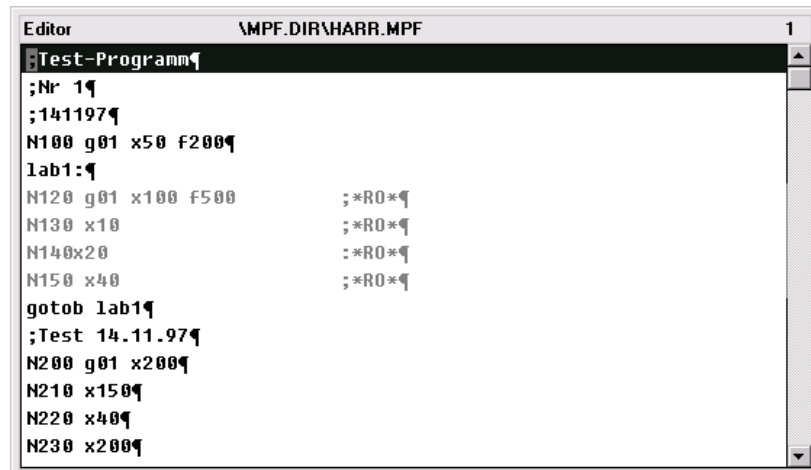

```

Editor          \MPF.DIR\HARR.MPF          1
Test-Programm
;Nr 1
;141197
N100 g01 x50 f200
lab1:
N120 g01 x100 f500      ;*RO*
N130 x10                ;*RO*
N140x20                 ;*RO*
N150 x40                 ;*RO*
gotob lab1
;Test 14.11.97
N200 g01 x200
N210 x150
N220 x40
N230 x200
  
```

Reserved character strings

Reserved character strings occur in part program code lines which are generated by calling cycles and programming contour definitions. They can be viewed by setting "Display hidden lines" in the editor.

The following character strings must not be used in part program lines that are directly input:

```

;#
;#END
;NCG
;*RO*
;*HD*
  
```

Additional information

When creating a program template, remember to position the "Read Only" identifier directly at the end of the block.

6.4 Structured step sequence display (option)



Advantages:

Structure

CTRL	I
------	---

Function

You can either edit a part program in the ASCII editor (standard display) or in step sequence display ("Sequence" softkey).

Configuring the SEDITOR.INI file enables NC programs to be displayed in a structured manner without changing the program. In addition, the "SEFORM()" instruction can be inserted for a structured step display.

The step view improves the readability of the NC program. Step sequence display has the following advantages:

- Quicker sequence detection
- Quicker navigation
- Easier sequence editing (block functions at step level: e.g., modifying the sequence)
- Single keystroke (Recompile or Input) to access the standard ASCII editor environment (ASCII or dialog with support functions such as cycle screens, contour calculator).

If you have created your own user cycles, which you use regularly in several programs and want to display clear steps, please contact your machine supplier so that a user-specific SEDITOR.INI can be placed in the user area for you.

Specific keywords stored in the configuration file are searched for in the ASCII program of the loaded program. These are then assigned to the primary level or secondary level to create a structure for the step sequence display. As a result, a structured display can be achieved in so-called step sequences without changing the ASCII program. The special display of control structures such as IF, THEN, ELSE, GOTO, CASE, FOR, WHILE, etc., has not been considered here. Using the SEFORM instruction it is possible to achieve additional structures in the program, if required. Pressing the keys CTRL + I will insert a predefined SEFORM instruction in the SEDITOR.INI.

The configuration file stores the following information:

- Which single or multi line sequence is recognized as a step (e.g., cycle call, contour element, WAITM call)
- Which step identifier and which symbol is displayed instead of the recognized sequence
- To which level (0-Primary level/1-Secondary level) a symbol and to which step identifier the recognized sequence should be assigned.

6.4 Structured step sequence display (option)

This ensures that an existing program can be displayed in steps without intervention.

If you wish to store your own icons or use existing ones, please contact your machine supplier.



Switch view

You can toggle between two views in step sequence display: The secondary level is either shown (+ Expanded) or hidden (– Collapsed).

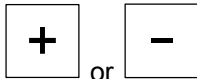

You can toggle between both views using these buttons.

Example "Collapsed" view

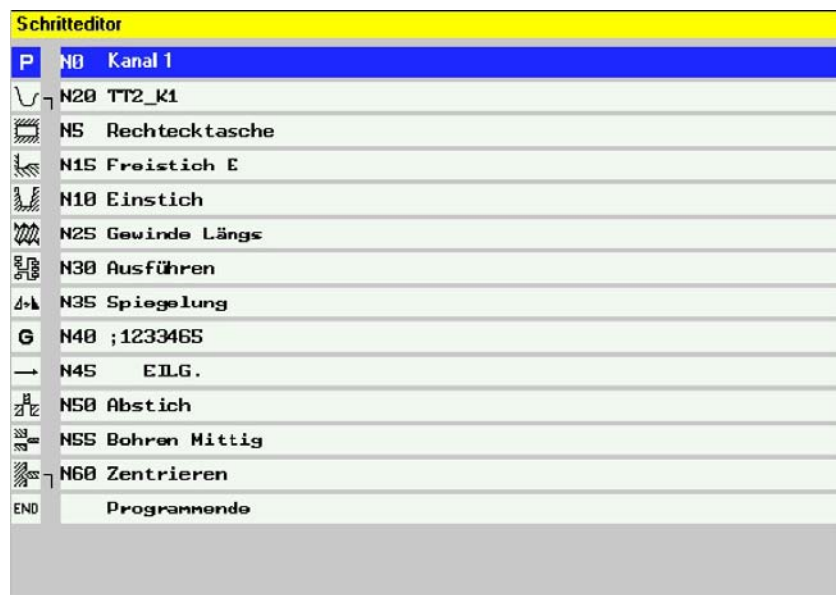

Example "Expanded" view

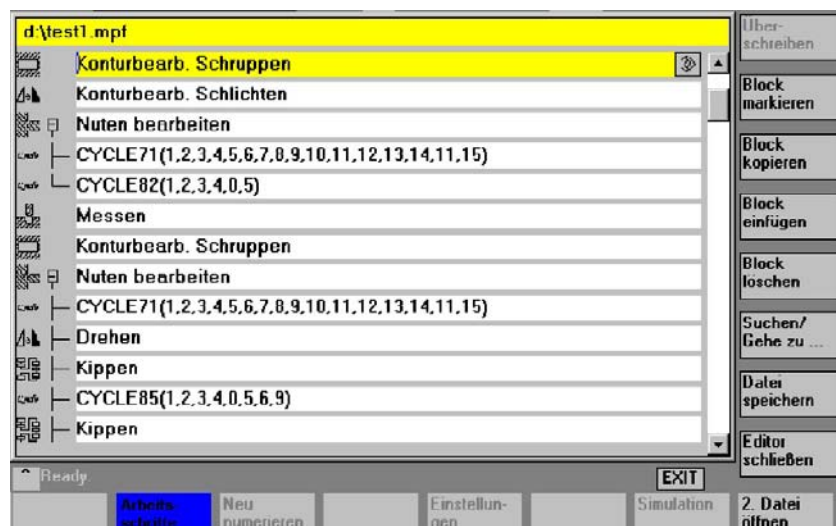



References

For more information, please refer to:

- IAM / IM4, Chapter "Configuring settings using INI files" for the SEDITOR.INI file
- /PGA/ Programming Guide Advanced, Chapter "File and program management" for the SEFORM instruction



Select step sequence display When requested via the softkey, the part program in the editor is displayed in steps.



Sequence

To display a program selected in the editor in step sequence format, press the "Sequence" horizontal softkey in the expanded softkey bar. A new program only displays the empty step "End". The new program steps must be inserted before this step.



Additional information

- If a program contains a SEFORM instruction in the first 500 lines, step sequence display is automatically activated after opening.
- If you switch over to the dual editor, step sequence display is applied to both editor panes. When you switch back to the ASCII editor, both panes change to ASCII display.
- Combined step sequence and ASCII editor view is not supported.
- Options are required, if you wish to edit a program with SEFORM instructions in anything other than the ASCII editor.



Sequence of operations

Operation is virtually identical to that of the ASCII editor; the only different key functions for the step editor are:



and

Edit



INSERT

Recompile

OK

- Steps such as G code and WAIT markers are opened with the ASCII editor.
- All standard cycles and contours can be recompiled.

Press INSERT to insert a new step before the currently selected step. The editor window is automatically opened. The new step becomes visible in the step sequence display via the step name and - if configured - the associated icons.

Default text is free DIN code with G icons. New steps are added using cycle support.

Each new work step which is started on the same level with SEFORM, is the end of the preceding work step for this level.

Instead of the step name strings you can also write the text numbers which are used in the file with the configured (alarm) texts. Enter them in the format \$8xxxx. They are then displayed in the currently active language.

Mark
block

With **collapsed** display, the entire step is highlighted with all substeps and can be copied or deleted as required.

With **expanded** display, the selected steps are highlighted.

Note

If you have switched between "Expanded" and "Collapsed" view while sequences were highlighted, the highlighting is removed for the sequences.

Copy
block

All selected steps are copied to the clipboard and can be inserted anywhere in the active channel or in another channel program (step or ASCII view). The clipboard is valid for each operating area at a time. An editor which is, e.g., activated by the simulation or as a correction editor cannot access the clipboard, which contains data created in the Program operating area.

Find/
Go to...

Find If the search term is located in the step identifier, the cursor is positioned on the step. If the search term is not found within a step, a message is displayed "Search text not found". This is because only the displayed step identifiers are included in the search. The search works in the same way in the collapsed step sequence display and individual hits are only possible within the step identifier at zero level.

Go to: If the block number is located within a step, the cursor is positioned on the primary level or secondary level of the step.

6.5 Multi-channel step sequence programming (option)



Application

Function

Multi-channel step sequence programming is an extension of the single step sequence display to several channels.

Support is provided with the following tasks when working with multi-channel workpiece programs:

- **Open** by pressing the “Edit workpiece” softkey” once: All programs, which should be selected and executed in several channels simultaneously, are loaded into the editor.
- **Display** the step sequences of several programs: Left icon column per channel; right step display of the selected channel. You can switch between two display modes:
 - Standardized and synchronized view during program generation before executing a trial run
 - Time-proportional and synchronized view after executing a trial run on the basis of times recorded per step.
- **Navigate** in the channel’s program (cursor up/down as well as previous/next step of same type) and from program to program of neighboring channels (cursor right/left)
- **Edit** the program in the standard ASCII environment (recompile or input softkey) or using the block functions at step level (change sequences in the program or distribute across programs).
- **Optimize** the sequence, processing time: Including the “Record times” program control, traverse programs.

The program sequence is monitored using “traces”, which record the times for each step in the DAT file and form the basis for the time view. Based on this time-proportional view, programmers can quickly recognize which steps require a long time and carry out a redistribution or change in the sequence in relation to the channels.

Note

The preconditions for support when opening multi-channel workpiece programs can be configured by the machine manufacturer or machine setter: See “Create programming support for multi-channels”.



Preconditions and configuration

The "Edit workpiece" softkey enables you to edit a workpiece in the step editor.

The program directory offers the following files for channel assignment:

- Select a workpiece directory in which a DAT, JOB or MPF (with INIT/START) file with the same name is stored.
- Directly select a DAT file
- Directly select a JOB file using Select instructions
- Directly select a MPF file using INIT/START instructions.

It is also possible to create the channel assignment under a workpiece directory, e.g., for certain sequences on the machine stored in separate channel programs (setup, remove stock, measure...).

In this case, you are recommended to store the most frequently used scenario in the file *workpiece name.DAT*, **.JOB* or **.MPF*. If you only want to open the setup scenario, select *Setup.name.DAT*, *.JOB* or *.MPF* in the data selector.

Edit
workpiece

To activate the step sequence display, press the "Edit workpiece" softkey and

- Select the workpiece in the workpiece directory WPD
- Select the JOB list
- *<Workpiece name>.MPF* is available (and no JOB list or DAT file with the same name).

If these preconditions are met, the DAT file is created or updated for:

- Section [Environment*] → Multi-channel program display and editing
- Section [TimeData_*] → Recorded time for time-proportional step sequence display
- Basis for section-by-section simulation (see Chapter "Program simulation")

Settings.

If step sequence display is active (single-channel and multi-channel) you can use the softkey to select whether, e.g., the times are to be specified in the step sequence displays next to the step identifiers. The settings become active immediately.

Templates

As with the JOB list, the internal file *workpiece name.DAT* for coordinating the multi-channel step sequence display and simulation can also be created from a template.

A *workpiece name.DAT* file is only created/entries entered in this file if the files were selected via *workpiece name.WPD*, *workpiece name.JOB* or *workpiece name.MPF*.

It is updated upon selection of a multi-channel program and the "Edit workpiece" softkey and when timing is active.

See also:

Chapter Commissioning operating area, HMI, "System settings".



Sequence of operations

Open

With a single keystroke, all of the MPF available for a workpiece are opened in the assigned channel (Load/Unload/Select via job list), i.e., the corresponding programs no longer have to be selected individually in the data selector, but rather the workpiece softkey can be selected directly if all the necessary preparations have been made.

For existing part programs, which are shown in the step sequence display, the following preconditions must be met before opening:

The channel assignment is defined in the following files:

- JOB list
- DAT file
- START/INIT in a start program

DAT environment

The DAT file contains the description of which program should be opened and in which channel (channel number) of the machine (NC) this should be called up for execution; this is also referred to as the DAT environment.

Create a DAT file

If this file does not already exist in the workpiece directory, it will be created automatically under the following preconditions:

- <Workpiece name>.job with the same name exists and this job list contains select instructions.
- Can be derived from the information required for the DAT environment.
- <Workpiece name>.mpf with the same name exists and this part program contains INIT/START instructions.
- Can be derived from the information required for the DAT environment.

As soon as a DAT file has been created and is available, a check is carried out each time it is opened to ensure that the DAT file has the latest time stamp. If the time stamp is not current, the file is updated.



Sequence of operations

Navigate



or



SHIFT

NEXT
WINDOW

or



TAB

or

NEXT
WINDOWPAGE
UPPAGE
DOWN

A step is searched for in the channel to the left of the current channel - which is executed at approximately **the same time** as the one just viewed. If the current channel is the leftmost channel, then the search is performed in the rightmost channel.

A step is searched for in the channel to the right of the current channel - which is executed at approximately **the same time** as the one just viewed. If the current channel is the rightmost channel, then the search is performed in the leftmost channel.

Return to previous/go to next **step**.

Back to previous step with the same **execution** (icon)

Go to next step with the same execution (icon)

Return to the previous **synchronization mark**

Go to the next synchronization mark

Further operation corresponds to the single step sequence display.

6.5.1 Multi-channel workpiece program views



Window structure

Function

The basic structure is the same for all display modes:

- Graphic section (left) with icons for the channel columns
- Step editor section (right) with icons, level symbols and step identifiers in ASCII

The size of both sections can be adjusted, so that there is always sufficient width for displaying and reading the step identifier, regardless of the number of channels.

Views

There are 3 display modes:

- **Standardized view**, all step sequences are the same length: Only if no current time data exist.
- **Synchronized view:**
The synchronized view can be selected without a preceding timing operation. Press the "Find/ synchron. WAIT markers" softkey to change to the other view.
- **Time-proportional view:**
Current time data are required for this view.

Number of channels

Up to 10 channels can be opened and displayed side-by-side at any one time.

The channels on a machine involved in a workpiece program can vary. This view is supported in that the associated step sequence icon column is only displayed for the programs of one channel. The width of the step sequence icons is defined dynamically.

Switch displays

The following transitions between display types are available:

- When first opened:
 - No time data available → Standardized view
 - Time data available → time-related view
- **In standardized view:**
only change to synchronized view possible.
- **In time-related view:**
only change to synchronized view possible.
No change is possible to the standardized view, as the steps and channels already have the correct relation to one another in the time-related view.
- **In synchronized view:**
change to synchronized view possible, if
 - No time data available → Standardized view
 - Time data available → time-proportional view

Synchron.
view

Switch to the standard ASCII editor

You can change directly from the MCSP to the standard ASCII editor using the ASCII view softkey. The program which has the focus is then displayed as usual. You can return to the opened MCSP environment with or without changes using the Close editor or Cancel buttons.

Display mode



Standardized



Time-proportional



Synchronized

Updated state



Data is up-to-date.



Data is modified.

The timing operation must be repeated whenever changes are made to the program. The icon columns are marked with the associated channel numbers. The channel which has the focus (highlighted) is displayed at the top left with the channel name. The step identifiers on the right belong to the program which has the focus. The selected step is marked as identifier text and icon.

When changing between standardized and synchronized views the step sequence display is updated as on opening.

Standardized view

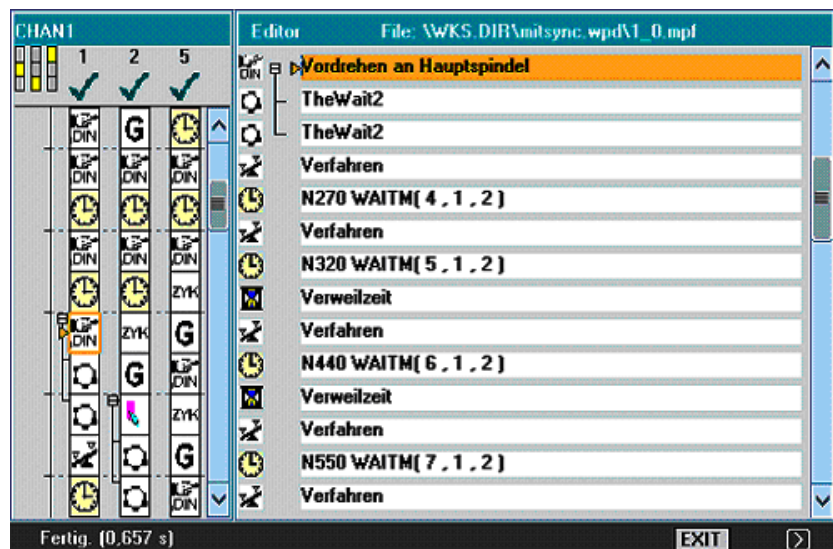

Properties

Each step in the left window is displayed as a graphic (icon column per channel) in standardized pixel height, regardless of its content. Step identifiers are displayed for the program which has the focus; the program for channel 1 on the above screen.

6.5 Multi-channel step sequence programming (option)

Time-proportional view

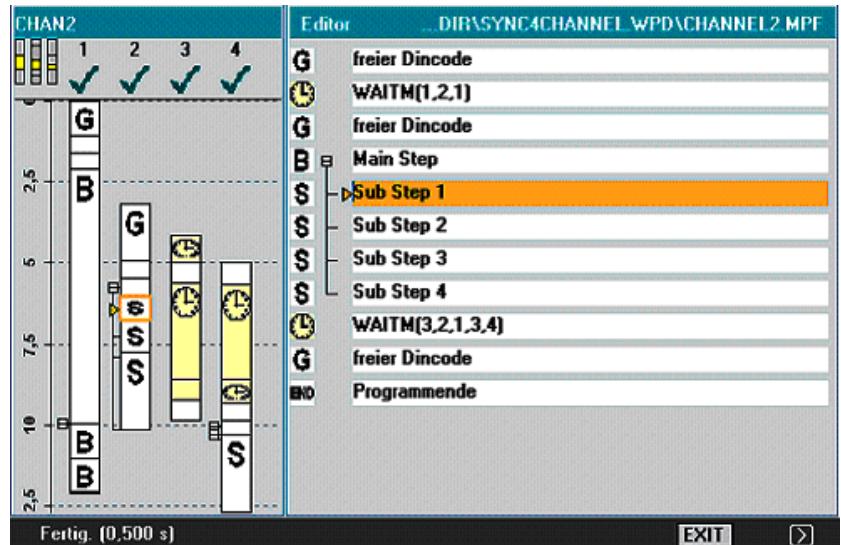

Properties

Steps are displayed in the left window in proportion to the duration of their execution time. In the case of WAIT markers, the step length (i.e., the number of pixels in height) is displayed in proportion to the waiting time.

Precondition for time-proportional view

Timing by means of the execution of the workpiece program must have been performed. If timing has not been performed, the standardized view is displayed.

 Programs which have been modified following timing are marked with "Data modified".



Computing the time again sets all programs to "Data updated".

Synchronized view



Synchron.
view

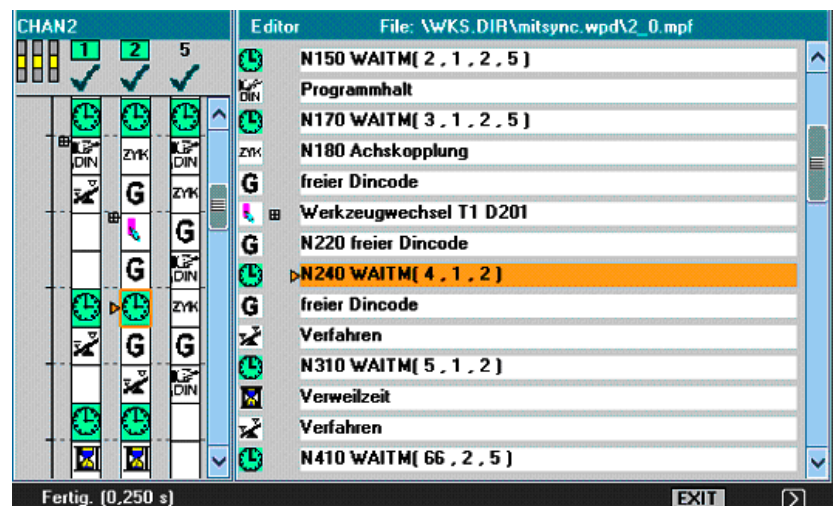

Properties

The icons are displayed in a fixed size regardless of the time required for the step. The grouped synchronization steps are displayed in parallel with the channels (horizontal to one another) and filled with empty steps if the number of steps is uneven.

After switching to synchronized view, the data of all programs are

initially "up-to-date". Making changes can lead to programs being marked with "Data modified".

When you change back to standardized view and back to synchronized view all programs are re-synchronized and displayed as "up-to-date".

Significance of icon background color

If you position the cursor on a synchronization icon additional states from a **channel view** are shown by means of the icon's background colors.

Green:

Correct synchronization step -> The synchronization syntax/parameter assignment specified in the configuration file SEDITOR.INI is recognized. All addressed partners are found.

Cursor on synchronization icon: The channel is affected by this synchronization and synchronization partner found.

Yellow:

Not all partners can be checked: A channel number cannot be opened. At least one channel is addressed in the synchronization syntax that is not contained in *workpiece.DAT*. There may be an error in the program.

Cursor on synchronization icon: The channel is affected by this synchronization, but at least one of the specified channel numbers is not registered in the *workpiece.DAT* file.

Red:

Not all partners were found: An error is pending in the synchronization syntax. Consequently, the synchronization syntax must be checked and the faulty synchronization programming corrected in the addressed channel.

Unsymmetrical channel numbers in respect of synchronization partners found.

Examples are:

Channel C1 WAITM(99,1,2,3)

Channel C2 WAITM(99,1,2)

Channel C3 WAITM(99,1,3)

Cursor on synchronization icon:

In this channel, the partner was not found or the channel for the synchronization icon which has the focus contains at least one channel number from *workpiece.DAT* in which the partner being searched for was not found.

Programming must be modified either in the selected channel (too many or incorrect channel numbers specified) or in the searched channel (missing synchronization).

Synchronization errors

The channel is affected by this synchronization but the specified channel number does not match the selected synchronization icon.

The difference in the number of channels is crucial for unsymmetrical channel numbers. The number of the channel in which the WAIT marker is programmed must not be included.

If the sequence is dependent on which channel reaches the WAIT marker first, an error is pending in the synchronization programming.

The first synchronization that was not found (red) is output in a dialog box:

Pos. block
number.

Synchronization string, channel, channel to be synchronized:
Further information on the cause of the fault can be obtained by positioning the cursor on the block number.

Abort

“Abort” softkey.

Notice**Synchronous display of WAIT marks**

WAIT marks can only be used once, otherwise errors can occur for the synchronous display.

Example:

Channel1:	Channel2:	Channel3:
WAITM(30,1,2)	WAITM(30,2,1)	---
WAITM(35,1,2)	WAITM(35,2,1)	---
WAITM(30,1,2,3)	WAITM(30,2,1,3)	(WAITM(30,3,2,1))

In this special constellation, there are no unique specifications as to how synchronization should be executed, i.e. the first WAITM of each channel has the same WAIT mark number 30, but they are completely independent of one another.

The result of the synchronization depends on the channel which you used to start synchronization: If you start with either Channel 1 or 2, synchronization runs without any problems and the expected result is supplied. However, if you start with a channel number, then an error is definitely output.

6.5.2 Activating timing



Timing

Function

Timing for steps is based on the monitoring of times per step and per channel in relation to the program end or reset states of all involved programs (end of step per channel and creation of TimeData_* entries in the relevant file).

Preparation phase - Message:

Timing initializing. Please wait....

Initiation of execution – Message:

Timing is active.

After completion - Message:

Recorded data is processed. Please wait....

Timing is activated in the Machine operating area under “Program control”. The steps are initialized for all channels stored in the relevant DAT environment.

Programmbeeinflussung	
<input checked="" type="checkbox"/>	DRY : Probelaufvorschub
<input checked="" type="checkbox"/>	ROV : Korrektur Eilgang
<input type="checkbox"/>	M01 : Programmierter Halt 1
<input type="checkbox"/>	M101: Programmierter Halt 2
<input type="checkbox"/>	DRF: DRF - Verschiebung
<input type="checkbox"/>	PRT : Programmtest
<input checked="" type="checkbox"/>	Zeitberechnung
<input checked="" type="radio"/> SBL1: Stop nach jeder Maschinenfunktion <input type="radio"/> SBL2: Stop nach jedem Satz <input type="radio"/> SBL3: Stop im Zyklus	

Edit
workpiece

The multi-channel program display is opened when you press the "Edit workpiece" softkey once the above listed preparations have been completed.

Evaluation and optimization

Reposition the steps or synchronization points (WAITM()) so that multi-channel execution improves parallelism and therefore shorter workpiece processing times:

- Select extremely long steps and analyze the environment
- Redistribute some tasks across the channels (e.g., break down longer-lasting steps so that processing can be carried out by several channels in parallel)
- Optimize synchronization between the channels
- Change the technological process (e.g., use steel profiles or special tools with a shorter processing time)

Additional information

After making changes to the program, you need to process the workpiece again to compute the new times.

Programs which have been modified are marked with a red X until the times have been updated.

If timing has not been performed, all steps in the program are displayed with equal time lengths. The computed times are saved in a .DAT file for each workpiece.

6.5.3 Activating simulation



Function

The multi-channel step sequence display also supports multi-channel simulations. Here, the NC language labels such as **WAIT2: WAITM** are inserted in the NC part program. The labels are removed again when you exit the simulation and return to multi-channel step sequence display.

The labels continue to remain in place, if you are in the simulation or in the correction editor and also:

- The control is switched off.
- The write access for the opened file is canceled.

Multi-channel, section by section program simulation

There are specific NC instructions for program coordination for synchronizing program execution as required for multi-channel manufacturing of workpieces: (*INIT(..)*, *START(..)*, *WAITM(..)* etc.). In principle, they can be used to start independent program sections in parallel channels almost *simultaneously* and synchronize them via e.g.

WAITM(Marker No., ...) once the associated machining operations have been executed and before starting the next sections.

Simultaneous aspects can only be sequentially emulated with simulation. **NC program labels** serve to **mark program sections**. Emulating the multi-channel program coordination in the simulation assumes that NC instructions for program coordination were marked with NC labels (*manually or automatically during program generation*). Simultaneous operational sequences which are independent of one another are executed one after the other in the respective channels (*channel change per section required*), before sequences are created for the next sections in the same manner. The result in the simulation is a *similar* sequence of machining steps to that on the machine.

Limitations

- Only **one** out of 10 possible channel instances can be assigned to the single-channel graphic module (simulation display) **at any one time** (*no simultaneous mode for channels!*). Commands for multi-channel program coordination (*INIT(..), START(..), WAITM(..) etc.*) are not executed in the program interpreter for the simulation.
- Partial processing of the "channels" on the same stationary blank are **superimposed**.
- **Path labels** are universal markings/section structure aids in NC programs which can trigger specific actions during the simulation run:
 - Path labels can be optionally displayed in the graphic
 - The intermediate time can be computed for sections delimited by path labels.
 - The graphic state can be stored temporarily for sections that are delimited by path labels.

Path labels have a defined label syntax: Identifiers for simulation should exist singly in one NC block in so far as possible.

- *The channel changes section by section with defined path labels (NC program labels).*

Section limitation using path labels

If the "Stop label" column is clearly defined, the "Start label" is created implicitly:

- An empty "Start label" field has the same meaning as a start from the beginning of the program
- An empty "Stop label" field has the same meaning as a stop at the end of the program
- With the same "program name", the "start label" of a section is equal to the "stop label" of the preceding section
- If start and stop labels are not specified, the entire program is executed.

JOB list

If a job list or a corresponding list of the step editor (MCSP) exists in the current workpiece directory, when simulation is selected, then the machining list, is automatically pre-assigned - if this still does not exist.

After confirmation of the machining list with OK, the relevant [JOB] section is generated in the workpiece-specific DPWP.ini file.

The following entries are managed:

- Program name.type
- Channel number
- Spindle unit: Main spindle, counterspindle, variable
- Start label (path label)
- Stop label (path label)
- Length of the machining list (number of sections)

The machining list can be updated at any time via the "Channel/spindle" menu.

Simulation sequence

The simulation sequence is controlled by the contents of the machining list menu "Channel/spindle" and supports simulation of multi-channel program coordination:

- Selecting the list validates the specified operational sequence.
- In each sequence step the designated program can be fully executed - as before - (*i.e. from program start to M2/M30 or M17*) in the specified channel by leaving the fields "Start label" and "Stop label" empty
- With each sequence step you can change to a different channel at the section of another program (*section by section channel change*) up to the specified "Stop label".
- If a label which was not previously defined as a "Stop label" for the sequence is specified in the "Start label" field, an implicit search run will be performed (*without output of graphics*) up to the "Start label" in the selected program before the simulation run is started.
- If the label assignments are inconsistent, the simulation is reset to the last valid state and a message is issued to this effect, e.g. "Label xxxxxx not found. Adapt label definition in machining list or adapt part program!".
- Each sequence step should be started separately and can also be reset separately.
- Section-by-section change of the spindle unit within the step sequence is permissible and controlled by means of keywords from the program.

- The section-by-section channel change during program run is only supported in conjunction with **specification of the corresponding program labels (path labels)**, which are either programmed manually or generated internally via integrated functions.

Simulation result

By superimposing the partial executions from the machining list **on a blank** the section by section simulation mode only changes for the sequence of machining sections in the graphic. There is no change in the overall result.

Search run

The list of machining steps (for which an intermediate model is available in the graphic module in the current simulation state) allows direct selection of a section in the simulation. See also "Display and colors"/Manage path labels.

The corresponding section is selected and confirmed with OK.

The simulation will start at the beginning of this section and is based on the state which the preceding section was in the last time its execution was completed.

Timing

Timing

The timing table shows an analysis **of the timings calculated from within the simulation** and encompasses the specified sequence of execution up to the current state of the simulated machining sections. The timing table is in cumulated form and takes into account the **defined downtime values** (for *T, S, M and H functions if present*); data is shown for the respective section limits.

The section limits are marked with the associated ASCII label derived from the "Stop label" (*if present*) or with M30 at the end of the program. Times are computed at each section end.

6.6 Multiple editor (option)



Starting point → graphic step view

After the softkey "Edit workpiece" is pressed, then the graphic step view is displayed:

- At the left with the so-called icon bars of all of the channel programs loaded in the MCSP
- At the right, with the so-called working step view of the channel in focus

**HSK1/9 ASCII view
→ multiple ASCII editor**

Using the HSK1(&=HSK9)"ASCII-View" (toggles with "working steps") from the MCSP step view, with a keystroke, then the program actually in focus is not as before displayed in a single ASCII full view, but instead is changed with the adjacent channels in a multiple ASCII full view that displays the 1-4 channel programs from the programs loaded in the MCSP next to one another in ASCII and offers all of the known editor functions.

6.6.1 Operator/display functions in the ASCII full views



Overview

Function

In addition to the known ASCII editor functions, the operator is offered the following functions:

- With the change into this multiple ASCII full view, the HSK1(&=HSK9) toggles at the "working steps" so that it is possible to directly toggle between the MCSP step view and the ASCII full view.
- Using the hardkey focus change, it is possible to change from left to right to the adjacent windows/channel programs.
- Using the HSK7 "Editor large" (or HSK15 depending on what the machinery construction OEM has configured, then a change is made into the so-called single ASCII full view with the display of the channel program presently in focus. In this case, one of the ASCII editors is placed over the complete width of the other editors. HSK7/15 toggles with "editor small" so that it is possible to return to the multiple ASCII full view with a keystroke.
- Using the HSK16 "channel selection" a channel selection dialog box is displayed both in the MCSP step view as well as also in the multiple ASCII full view.
- The graphic step display with the so-called icon bars is also displayed for orientation purposes; this means that the focus frame with arrow gives the operator the information as to which step his ASCII line belongs as long as nothing has been changed as a result of changes in the part program in the ASCII view after the last HSK1(&=HSK9) selection. This can be identified by the "checkmark icon" above the icon bar. As soon as a "cross icon" is shown here, then the step sequence has still not been updated

and especially steps that follow after the changed program locations are no longer up-to-date. The update of the steps can be forced by changing the view into the step view HSK1 working steps + renewed HSK1 ASCII view (parser run).

In addition, when using the mouse, it is possible to directly select a step – as long as it involves steps from channels that are currently selected or are displayed:

- The graphic step display with the so-called icon bars can be switched-in or switch-on using the channel selection dialog box subsequently described.

HSK7/15 Editor|Large → single ASCII editor

Single ASCII full view after pressing HSK "Editor Large"

HSK16 channel selection dialog box in the step view

The following dialog box is displayed if HSK16 is pressed in the step view:

Using this dialog box, the user sets the behavior of the MCSP for the transition from the environment work steps into the multiple ASCII view.

The user can either select an automatic ("automatically determined using synchronization") and a manual ("manual entry") channel selection.

Pre-assignment (default setting) of the dialog box

When this dialog box is displayed, it is pre-assigned (default settings) the subsequent entries from the section [MultiASCIIView] of the SEDITOR.INI.

- **"SyncAlgo" key**
This specifies the channel selection type.
0 – manual entry
1 – automatically determined through synchronization (default)
- **"ChannelPreselection" key**
Specifies the channels for the "manual entry".
e.g. ChannelPreselection = 1,3
without default
- **"MaxChannels" key**
Specifies the number of channels to be displayed for the automatic determination.
- **"SearchDirection" key**
This specifies the direction of the search after the synchronization step.
0 – upwards (default)
1 – downwards
- **"WithStepView" key**
Specifies the display of the graphic step view ("icon bar").
0 – no graphic step view
1 – with graphic step view (default)

Additional keys that are not listed in the dialog box, but decisive for setting the ASCII full view:

In SEDITOR.INI also in section [MultiASCIIView]

- **"ZoomFont" key**

Specifies whether the font of the editors should be zoomed in the m-ASCII view - or not.

0 – VGA font, the font is not zoomed (default)

1 – the font is zoomed

In MCSE.INI in section [General]

- **"SwitchHSK7_15" key**

This specifies whether in MCSP the HSK7 is assigned with "Simulation" or with "Editor large|small" in exchange with HSK15.

0 – no exchange (default)

1 – exchange HSK7 with HSK15 contents

Automatic determination through synchronization

For the automatic channel selection, starting from the step currently in focus in the step view, the next synchronization step is determined. Of course, initially it is checked as to whether the step current in focus is a synchronization step. If it is not a synchronization step, then depending on the selected search direction, a search is either made upwards or downwards.

If a synchronization step was able to be found, then from this associated synchronizing channels/MPFs are determined.

Example:

A WAITM(99,2,3,5,7) in channel 3 supply the synchronizing channels 2, 5 and 7. To start, the found synchronizing channels/MPFs are filtered as to whether the files are also currently opened in the MCSE. Channels/MPFs that are not in the synchronization command are ignored. For instance, referred to WAITM(99,2,3,5,7): Existing channels: 2, 3, 5 → synchronizing channel 7 is ignored.

A check is then made as to whether the number of channels to be displayed was complied with.

The following rules apply:

- The number of channels to be displayed (refer to the entry "number of channels") must lie between 1 and 4.
- If a larger number is obtained from the number of filtered synchronizing channels, then starting from the channel currently in focus, a search is made to the left (sequence of the channels as in the graphic step view) for channels to be displayed - and if required, the search is continued from the far right to the left: → REMOVE
- If a smaller number is obtained from the number of filtered synchronizing channels, then starting from the channel currently in focus (sequence of the channels as in the graphic step view), a search is made for channels that are still not to be displayed - and if required, the search is continued from the far left to the right: → Fill-up

- If a synchronization step was not found, then starting from the channel currently in focus to the right of this, it is filled up, or if required, the search is continued from the far left to the right until the maximum number of channels to be displayed is reached.
→Fill-up

Manual entry

For the manual channel selection, the user is shown all of the MPFs currently opened in the MCSP in a tabular form. Using the checkboxes, the user has the possibility of selecting the channel programs he requires for display in the multiple ASCII view.

The following rules apply:

- The number of channels/MPFs selected for display must lie between 1 and 4. If the number lies outside this valid value range, then an appropriate message is displayed with the "OK" or "Save" softkeys.
- Graphic step view:
This menu point can be used to determine whether the graphic step view – displayed at the left – ("icon bar") should be visible in the multiple ASCII view – or not. In order to obtain more space for the ASCII editors, it suddenly makes sense to hide the graphic step view.
The graphic step view takes up more screen width depending on the number of channels in the MCSP: for 10 channels, up to max. 60%.

Softkeys

OK

The "OK" softkey is used to accept the current settings – under the assumption that the setting check was positive. The display in the multiple ASCII view is then completely built-up again.

Abort

The "Abort" softkey, the channel selection dialog box is executed without any further action.

Save

The "Save" softkey is used to accept the current settings in the SEDITOR.INI; these settings then become effective.

6.6.2 Alignment of the channels/MPFs to be displayed



HSK16 channel selection dialog box in the multiple ASCII view

Pre-assignment (default setting) of the dialog box

Function

The channels/MPFs are aligned with respect to one another when changing-over from the step view into the multiple ASCII view.

- Starting from the step current in focus, the steps are used that are at the same height horizontally in the graphic step view.
- Alignment in ASCII next to one another on a common reference line in the upper lines of the ASCII window.

Note

For the time-based view for cursor left/right, the end of step in time is used as reference to select the step in the adjacent channel.

However, it is not the last ASCII line of the step so obtained – but for the alignment of the channels next to one another, in the reference line, it is the first line that is relevant - the start of the step.

The following dialog box is displayed if HSK16 is pressed in the multiple ASCII view:

When the channel selection dialog box is displayed, the currently displayed channels/MPFs all of the channels/MPFs open in the MCSP are marked (selected) by activating the associated checkboxes in the list.

In this dialog box, the user can manually influence the channels selected by changing over into the multiple ASCII view. The possible settings correspond to those described in the section “Manual entry”.

The dialog boxes pre-assigned from the actual environment, this means:..:

- When “automatic determination through synchronization” is active, channels are selected sensitive to the context depending on the cursor when selecting the multiple ASCII view. When the dialog box is opened, these channels are selected in the checkbox.
- When channel selection “manual entry” is active, the last selected or those saved in the ini are selected – if no other selection was made.

Softkeys



OK

The "OK" softkey is used to accept the current settings – under the assumption that the setting check was positive. The display in the m ASCII view is then completely built-up again.



Abort

The "Abort" softkey, the channel selection dialog box is executed without any further action.

HSK16 channel selection dialog box in the single ASCII view

If HSK16 is pressed in the single ASCII view, the same dialog box is obtained – with the following difference: The cursor is located on the selection icon bar yes/no and returns to the single ASCII editor as long as nothing was changed regarding the channel pre-selection; otherwise, it returns to the multiple ASCII editor. The cursor in the opened dialog box is located on the graphic step view.

Re-numbering HSK11

The function is only effective for the channel currently in focus. This is the reason that it remains in the ETC bar.

HSK13 settings

The settings made become effective for all opened dialog boxes (not only those that are displayed). This is the reason that a return jump is made to the main bar.

6.7 Free contour programming



Technologies



Function

Free contour programming is a support tool for the editor. The contour programming function enables you to create simple and complex contours.

An integrated contour calculator (geometry processor) calculates any missing parameters for you, provided that they can be calculated from other parameters. You can link together contour elements. Contour transition elements "radius" and "chamfer" are also provided.

The programmed contours are transferred to the edited part program.

The scope of functions of the contour calculator differs depending on the chosen technology:

Functions which are only available in the **turning technology** include:

- Toggling between radius/diameter programming (DIAMON, DIAMOF, DIAM90)
- Chamfer/radius at the start and end of the contour
- Undercuts as transition elements between two axially parallel straight lines, where one runs horizontally and the other vertically (Form E, Form F, thread undercut, free undercut)

Functions which are only available in the **milling technology** include:

- Contours with symmetry (mirroring)
- Contours with repetitions
- Combinations of both

The contour calculator takes into account **channel-specific** display machine data. As it does not know which channel the program is being created for, it always analyzes the display machine data of the **1st channel**.

Allowances parallel to the contour, which are required for grinding, can be created by free contour programming and modified again if necessary.

Contour elements

The following are contour elements:



Starting point



Straight line (planar, longitudinal, inclined)



Circular arc



A pole is a pseudo contour element. Straight lines and circular arcs can also be defined by polar coordinates in reference to a pole.

Additional information

1. The valid geometry axes in the first channel are determined and used in the part program.
2. The contour editor uses the last programmed axis position for the starting point, without allowing for previously valid G functions.
3. You must also specify the side on which the contour allowance should lie, e.g., "right" or "left".

6.7.1 Programming a contour**Sequence of operations****New contour**

Use the "Workpiece" and "Part program" softkeys in the Program operating area to select an existing program and press the "Input" key or open a new part program using the "New" softkey, enter a name and confirm with "OK". You are now in the ASCII editor.



The "Contour" softkey displays a vertical softkey bar with the following options:

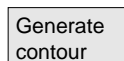

The contour calculator is activated to generate a contour chain from contour elements.

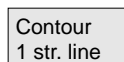

Preparatory cycles are displayed with help displays for creating straight lines and transition elements, if applicable.

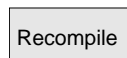
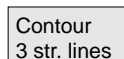
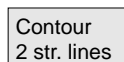

You can edit an existing contour by selecting the "Recompile" softkey. The editor cursor must be positioned inside the contour to do this.



Notice

Upon recompilation only the contour elements that were created with free contour programming are regenerated. In addition, only the texts that were added using the "Free text input" input field are recompiled. Any changes you made directly in the program text are lost. However, you can subsequently insert and edit user-defined texts, which will not be lost.



Define a start point

Sequence of operations

The input screen for the contour **start point** is displayed.

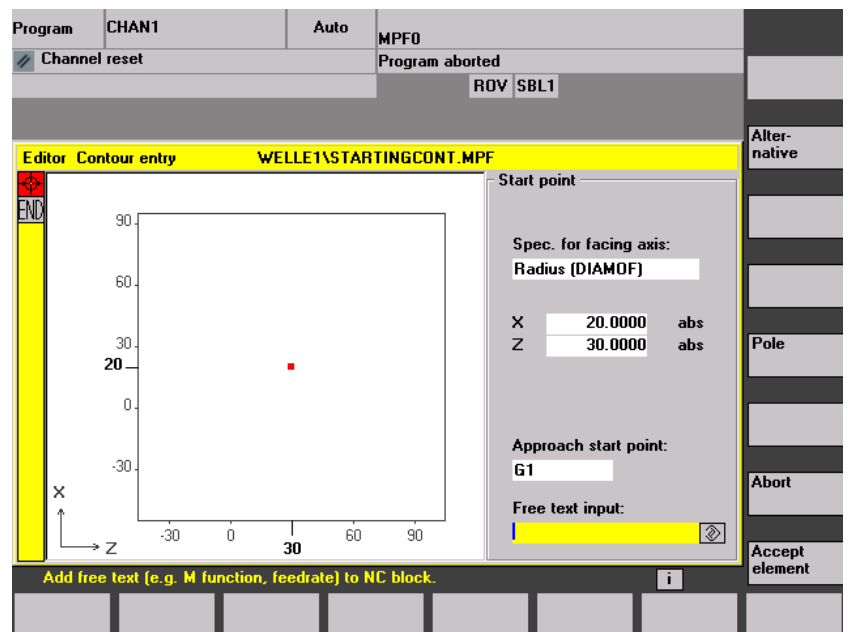

The input field with the input focus is indicated by the yellow background color. Once the input is acknowledged with "Accept element" or "Abort", you can navigate around the contour chain using the \uparrow \downarrow arrow keys. The current position in the chain is indicated in red.

Accept
element

Select the "Accept element" softkey to store the starting point. You can add the next element by selecting the appropriate softkey:

The approach motion to the starting point can be changed from G0 (rapid traverse) to G1 (linear interpolation) via the "Approach starting point" field. You can define a specific feedrate for G1 via the "Free text input" field,

e.g. G1 F0.3.

Alternative

1

0

...

Accept
element

Position the cursor on the "Transverse axis dimension" field and click on the field using the "Alternative" softkey (or with the "Selection" key) repeatedly until the dimension you require is displayed.

Enter the values for the starting point.

The values you have entered are accepted when you select "Accept element" and you can then add the next element by selecting the appropriate softkey.



Sequence of operations

Define contour elements

From the starting point enter the first contour element, e.g., straight line. Enter all of the data from the workpiece drawing: Length of straight lines, end position, transition to following element, angle of pitch, etc.

All
parameters

Select the "All parameters" softkey to display a selection list of all the parameters for the contour element.

If you leave any parameter input fields blank, the control assumes that you do not know the right values and attempts to calculate these from the settings of the other parameters.

The contour is always machined in the programmed direction.

INPUT

You can select an existing contour element with "INPUT". A new contour element is inserted after the cursor when you select one of the contour elements on the horizontal softkey bar; the input focus is then switched to the parameter input on the right of the graphic display.

You can navigate around the contour chain again after selecting "Accept element" or "Abort". The following contour elements (example for turning: G18) are available for the definition of contours.

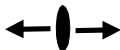
Horizontal
line

Straight line in the horizontal direction. Enter the end point of the straight line (incremental/absolute can be selected with the "Alternative" softkey), program the transition to the following element and then press the "Accept element" softkey.

Vertical
line

Straight line in the X direction.

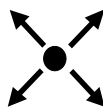
Str. line any
directio

Oblique line in the X/Z direction. Enter the end point of the line using coordinates or an angle.

Circle



Arc with any direction of rotation



Sequence of operations

Contour transition elements A transition element can be used whenever there is a point of intersection between two neighboring elements; this can be calculated from the input values.

You can choose to insert either a radius **RD** or a chamfer **FS** as the transition element between any two contour elements. The transition is always appended to the end of a contour element. You select transition elements in the parameter input screen for the relevant contour element.

The undercut transition element is only offered in turning technology, see Chapter "Undercuts in turning technology".

Abort

When you select "Abort", the contour element values are discarded and you return to the main screen. The input focus switches back to the contour chain.

Delete
value

The values for the element are deleted.



Radius or chamfer at the start or end of a turning contour.

In simple turning contours a chamfer or radius should generally be appended at the start and end of the contour.

These form a closure to the axially parallel blank:

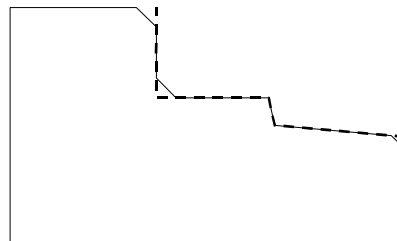

You select the direction of transition for the contour start in the starting point screen. You can choose between chamfer and radius. The value is defined in the same manner as for the transition elements.

In addition, four directions can be selected in a single selection field. You select the direction of the transition element for the contour end in the end screen. This selection is always listed, also if no transition was entered in the preceding elements.

Example

The selected transition chamfer on the contour start and its given value is displayed for clarity in an output field in the end screen next to the direction selection:

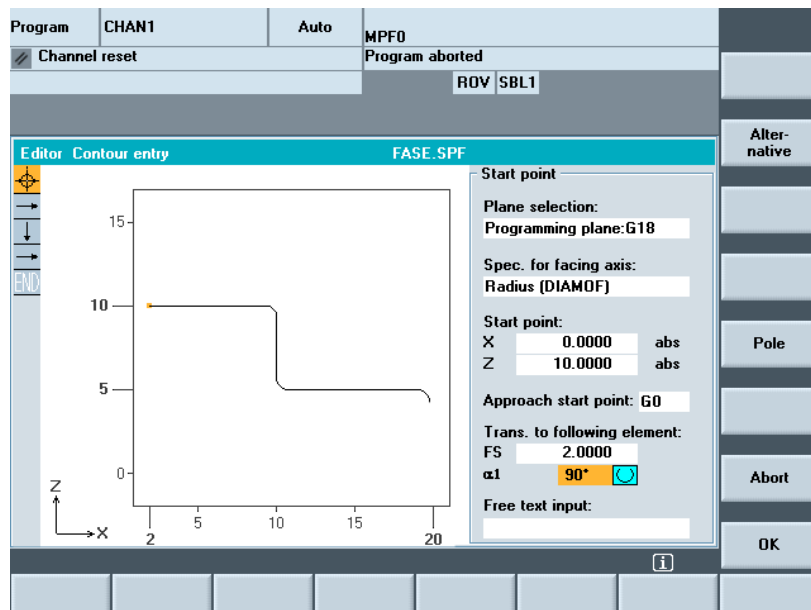
**Symbolic representation of contour elements**

The elements of the contour and pole, if applicable, are displayed next to the graphic window using symbols in the sequence in which they were programmed in a contour chain.

Parameter with gray background:

These parameters have been calculated by the control and cannot be altered.

When the programmable parameter input fields (white background) are altered, the control calculates new data, which are then immediately displayed in the input screen.

Input value is already calculated

With some contours, the control may already have calculated an input value from other settings.

Problems may then arise if the control-calculated value does not tally with the workshop drawing. In this case, you must delete the settings from which the control has automatically calculated the input value.

You can then enter the precise value from the workshop drawing.



Free text input

Under "Free text input" you can enter a comment that is inserted in the program at the end of the contour (e.g., specifying the technology, feedrate, M function).

Contour allowance

By selecting "Contour allowance", you can specify the allowance parallel to the contour and the side of the contour on which the allowance applies. It is displayed as an allowance in the graphics window.

It is possible to change the allowance and the parameters from the original contour. These changes are applied to subsequent machining operations in the part program, e.g., for grinding.

6.7.2 Undercuts for turning technology



Limitations

Function

The form E and F undercut and form DIN 76 and general thread undercut functions are only activated when turning technology is enabled.

The display machine data 9020: TECHNOLOGY is evaluated to determine the technology.

Form E and F undercuts as well as thread undercuts are only available if level G18 is set. Undercuts are only permitted on contour edges of the rotational body, which run in the direction of the longitudinal axis (usually parallel to the Z axis). The longitudinal axis is identified by the machine data.

The machine data 20100: DIAMETER_AX_DEF for turning machines contains the name of the transverse axis (usually X). The other axis in G18 is the longitudinal axis (usually Z). If in MD 20100: DIAMETER_AX_DEF does not contain a name or contains a name that does not conform to G18, there are no undercuts.

Undercuts only appear on corners between horizontal and vertical straight lines, including any straight lines, which are at 0°, 90°, 180° or 270°. A tolerance of ±3° is required here, so that conical threads are also possible (these undercuts do not meet the standard in this case).

Operator focus

When the operator focus is on "Trans. to next element", use the "Select key" or "Alternative" softkey to select Undercut.

When the focus is on the following field, the undercut form can be defined. The "Select key" or the "Alternative" softkey can be used to select the following options:

- Form E
- Form F
- DIN 76 thread
- Thread general

Operation

If the undercut form is specified, the RxT field can be opened with the input key and the desired coordinates can be selected with the cursor keys. The desired coordinates can also be selected by repeatedly pressing the "Select key".

If the diameter is already known when selecting the undercut, the list box displays a suggested value.

Za is the machining allowance (grinding allowance) permitted according to DIN 509.

Form E
Form F

DIN thread

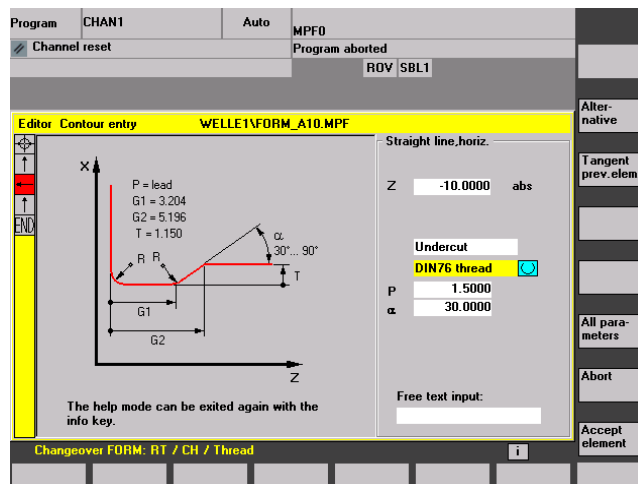

In the case of standard thread undercuts, the characteristic size of the thread pitch is P. The depth, length and transition radius of the undercut are calculated according to the DIN standard. The (metric) thread pitches specified in DIN 76 can be used. The arc-in angle can be freely selected in the 30°-90° range. If the diameter is known when selecting the undercut, an appropriate thread pitch is suggested. Forms DIN 76 A (external control) and DIN 76 C (internal control) are available. The program detects the two forms automatically using their geometry and topology.

Thread general

Based on the thread undercut according to DIN (see above) you can use the "General thread" undercut type to create specific undercuts, e.g., for inch threads. The following inputs can be made:

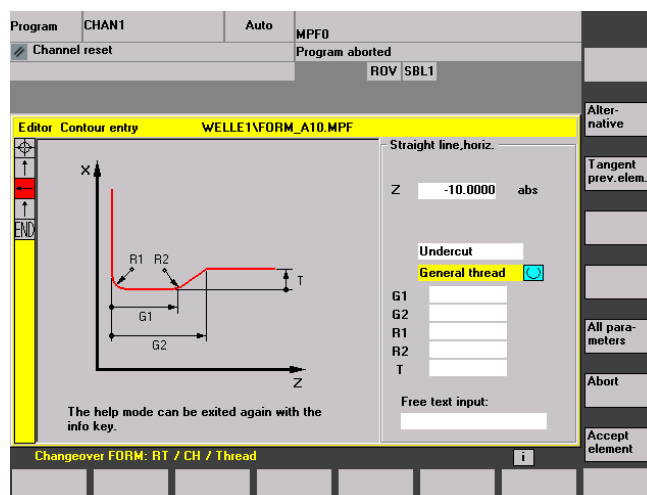

6.7.3 Parameterizing contour elements



Tangent to preceding element

Tangent
prev.

Display additional parameters

All
parameters

Alternative

Select dialog

Select
dialog

Select
dialog

Accept
dialog

Changing a selected dialog

Change
selection...

Select
dialog

Accept
dialog

Clear a parameter input field

Delete
value

Function

In principle, input screens are handled according to the same procedure already described for handling contour elements STRAIGHT LINE, OBLIQUE LINE and CIRCLE.

To help you to program a contour, the following softkeys are also available:

The "Tangent preced. elem." softkey presets the angle α_2 to a value of 0. The contour element has a tangential transition to the preceding element, i.e. the angle to the preceding element (α_2) is set to 0 degrees.

If your drawing contains further data (dimensions) for a contour element, select the "All parameters" softkey to extend the range of input options for the element.

The "Alternative" softkey is displayed only in cases where the cursor is positioned on an input field with several switchover settings.

Some parameter configurations can produce several different contour characteristics. In such cases, you will be asked to select a dialog. By clicking the "Select dialog" softkey, you can display the available selection options in the graphic display area.

Select the "Select dialog" softkey to make the correct selection (black solid line) and confirm your choice with the "Accept dialog" softkey.

If you want to change an existing dialog selection, you must select the contour element in which the dialog was originally chosen. Both alternatives are displayed again when you select the "Change selection" softkey.

You can select another dialog.

You can delete the value in the selected parameter input field with the DEL key or "Delete value" softkey.

Save a contour element

If you have entered the available data for a contour element or selected the desired contour by means of the "Select dialog" softkey, select the "Accept element" softkey to store the contour element and return to the main screen. You can then program the next contour element.

Append contour element

Use the cursor keys to select the element in front of the end marker. Use the softkeys to select the contour element of your choice and enter the values you know in the input screen for that element. Confirm your inputs with the "Accept element" softkey.

Select contour element

Position the cursor on the desired contour element in the contour chain, and select using the "Input" key.

The parameters for the selected element will then be displayed. The name of the element appears at the top of the parameterization window.

If the contour element can be represented geometrically, it is highlighted accordingly in the graphic display area, i.e. the color of the contour element changes from black to red.

Modifying contour element

You can use the cursor keys to select a programmed contour element in the contour chain. The "Input" key displays the parameter input fields. These can now be edited.

Insert a contour element

Use the cursor keys to select the contour element **after** which you wish to insert another element in the contour chain. Then select the contour element to be inserted from the softkey bar.

After you have configured the parameters for the new contour element, confirm the insert operation by selecting the "Accept element" softkey.

Depending on the new status of the contour, the contour elements below are updated automatically or when the cursor arrow is hovered over them. Contour elements that appear after the insertion point and are not updated are displayed in green in the contour chain.

Delete contour element

Use the arrow keys to select the element you wish to delete. The selected contour symbol and associated contour element in the programming graphic are highlighted in red. Then press the "Delete element" softkey and confirm the query.

Undo an input

By selecting the "Abort" softkey you can return to the main screen, **without** transferring the last edited values to the system.

6.7.4 Graphically displaying the contour



Function

The graphics window displays the progress of the contour chain as you configure the parameters for the contour elements. The element you have selected is displayed in red in the graphics window. Navigation within the contour is described in "Program contour".

The created contour element can be displayed in various line types and colors depending on its status:

Color/line	Significance
Black	Programmed contour
Red	Current contour element
Green	Alternative element
Black continuous line	Element is fully defined
Black dashed line with a black arrow	Selected element
Light blue line	Element is partially defined

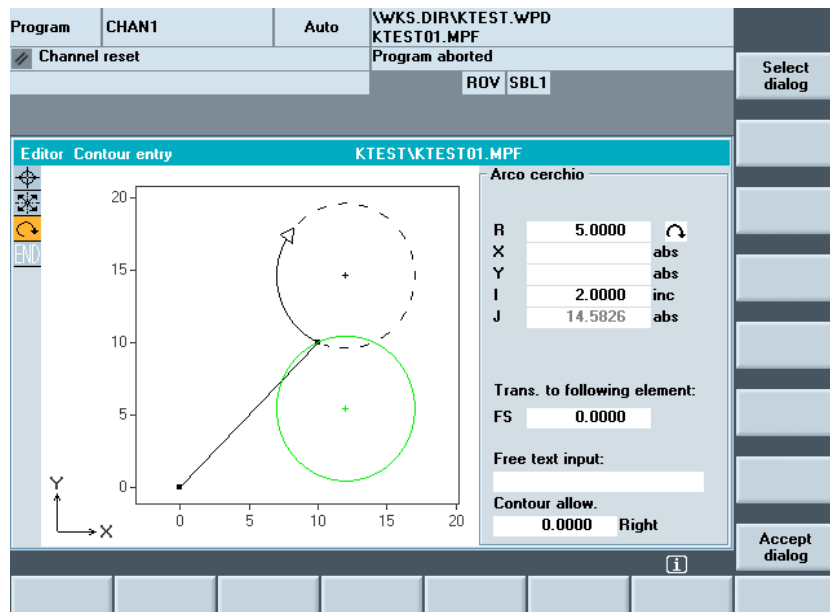

The contour is displayed to the extent it can be interpreted by the control on the basis of parameter inputs. If the contour is still not displayed in the programming graphic, further values must be entered. Check the contour elements you have already programmed, if required. You may have forgotten to enter all of the known data. The coordinate system scaling is automatically adapted to changes in the complete contour.



Contour allowance

The position of the coordinate system is displayed in the graphics window.

Here, you enter the complete description of the allowance parallel to the contour and the side of the contour on which the allowance applies.

6.7.5 Symmetrical contours with milling technology



Symmetries

Function

Milling contours are often symmetrical. To exploit the symmetry of contours only the relevant parts of the contour are input, the remainder is created through replication.

Closed symmetrical contours can be created through a combination of mirroring and turning repetitions:

- **Mirroring:**
The programmed contour can be mirrored in the starting or end point on any given straight line. In addition, a radius or chamfer can be entered in the mirroring point.
- **Repetition for closed contour:**
The mirrored contour can be closed to the left or to the right through repetition. In addition, a radius or chamfer can be input at the repetition corner points (similar to closing a contour from the end point to the starting point).

Example

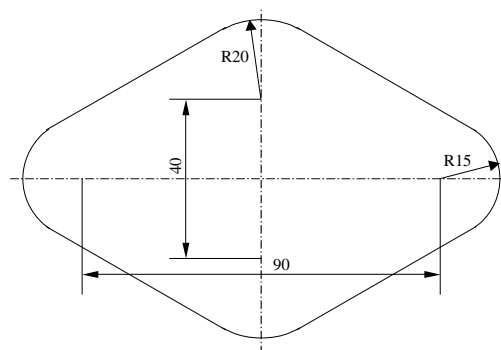

The relevant (non-symmetrical) part of the contour is described as standard:

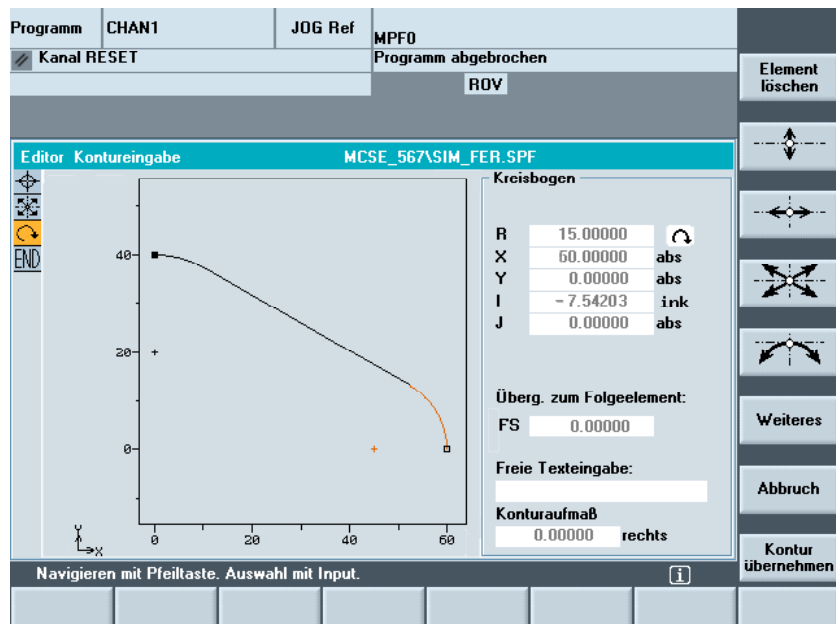

The finished contour is created through mirroring and repetition:

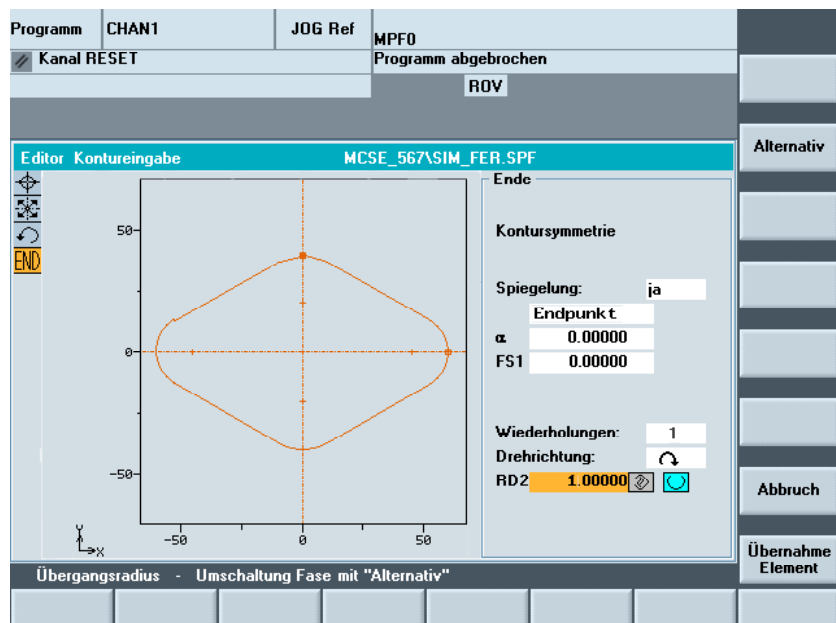

The lines of symmetry are displayed using a dashed line. The midpoint of the created contour is marked with a cross. The symmetry is only visible on the end point.



Broken-line graphics

In broken-line graphics, the contour is displayed with starting and end points. The cloned elements are marked without starting and end points. In addition, the lines of symmetry are displayed with dashed lines. In program overview, the entire contour is displayed without starting and end points and without lines of symmetry.

Chamfers and rounding

When mirroring, the contour is reflected in the starting or end point. A chamfer or rounding can be added at this stage.

During repetition, the open contour is cloned to create a closed contour. The number N shows how many parts are required to create the closed contour. A chamfer or rounding can be added between these parts. The direction of rotation for closing can be freely selected.

Example

Behavior of chamfers and rounding

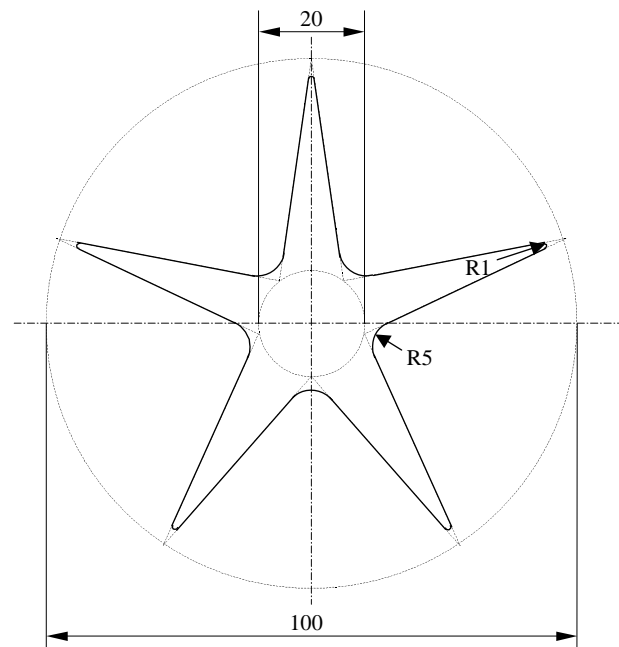

Maximum contour size

The maximum number of contour elements is limited to 250.
 $\text{Contour} * \text{Mirroring (1 or 2)} * \text{Repetition (N)} \leq 250 \text{ Elements}$

6.7.6 Specifying contour elements in polar coordinates, closing the contour



Function

The description given above of defining the coordinates of contour elements applies to the specification of positional data in the Cartesian coordinate system. Alternatively, you have the option to define positions using polar coordinates.

When programming contour definitions, you can define a pole at any time prior to using polar coordinates for the first time. Programmed polar coordinates subsequently refer to this pole. The pole is modal and can be re-defined at any time. It is always entered in absolute Cartesian coordinates. The contour calculator converts values entered as polar coordinates into Cartesian coordinates. Programming in polar coordinates is only available **after** entering a pole. The pole input does not generate a code for the NC program.

Pole

The polar coordinates are valid in the level selected with G17 to G19.



The pole is a contour element that can be edited, which itself does not contribute to the contour. It can be entered when the starting point of the contour is defined or anywhere within the contour. The pole cannot be created before the starting point of the contour.

Enter polar coordinates

More

Pole

Close
contour

Polar coordinates

The "More" softkey in the basic plane of the contour programming accesses the "Pole" subscreen and the "Close contour" softkey.

The pole can only be entered in absolute Cartesian coordinates. The "Pole" softkey is also present in the starting point screen. This enables the pole to be entered at the start of a contour, so that the first contour element can be entered in polar coordinates.

The contour is closed by a straight line between the last entered contour point and the starting point.

Additional information

If the straight line that was generated with close contour is linked to the start element of the contour with a radius or chamfer, the radius or chamfer must be specified explicitly as follows:

- Close contour, input key, enter radius/chamfer, accept element.
The result then corresponds exactly to what would occur if the closing element were to be entered with the radius or chamfer.
- Close contour can only be used for entering contour elements in **polar coordinates** if the starting point of the contour was set to polar and the **same pole** is still valid at the closing point.

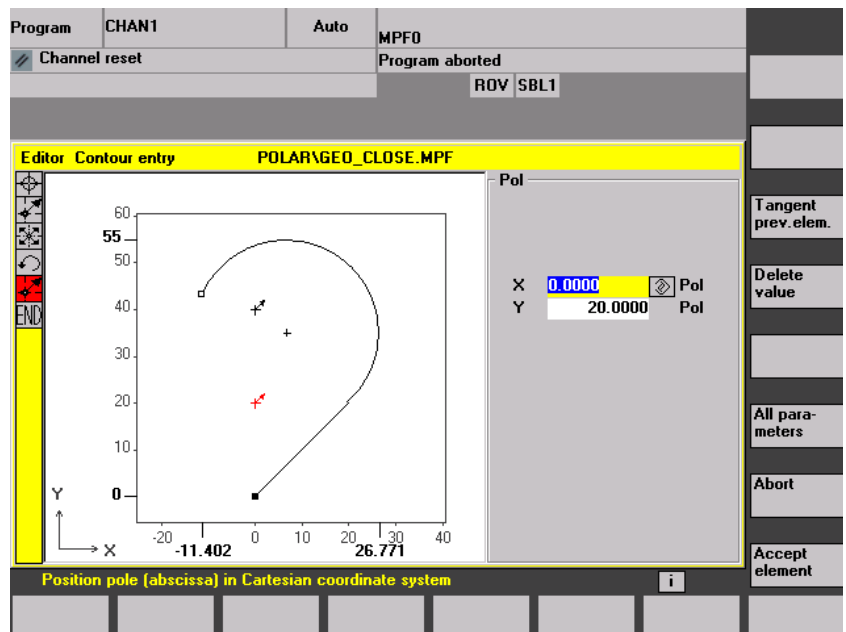

Input switchover: Cartesian/polar

Once a pole has been set – whether inserted at the starting point or subsequently – the contour elements can be entered as:

- Circular arcs
- Straight lines/(inclined)

or as polar coordinates. To switch between

Cartesian and polar coordinates additional toggle fields are displayed for "Straight line, any" and "Circular arc" in both the basic contour input view

and the view with "All parameters".

A toggle field is not displayed if no poles exist. Input fields and display fields are then only available for Cartesian values.

Absolute/incremental input Absolute and incremental polar coordinates can be input for "polar". The input fields and display fields are labeled **inc** and **abs**.

Absolute polar coordinates are defined by an absolute distance to the pole that is always positive and an angle in the range of $0^\circ \dots \pm 360^\circ$. When absolute dimensions are specified, the angular reference is based on a horizontal axis of the working plane, e.g., X axis with G17.

The positive direction of rotation runs counter-clockwise.
If there are several input poles, the definitive pole is the **last pole** before the input or edited element.

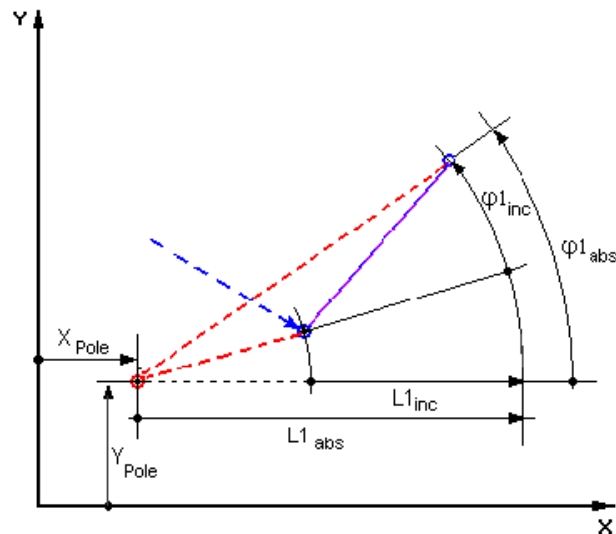

Incremental polar coordinates relate to both the definitive pole and the end point of the preceding element.

For an incremental input, the **absolute distance** to the pole is calculated using the absolute distance from the end point for the preceding element to the pole plus the length increment that was entered. The increment can be positive or negative.

The **absolute angle** is calculated accordingly using the absolute polar angle of the preceding element plus the angular increment. Here it is not necessary for the preceding element to have been entered as polar.

In contour programming, the contour calculator converts the Cartesian coordinates of the preceding end point using the definitive pole into polar coordinates. This also applies if the preceding element has been given in polar coordinates, since this could relate to another pole if a pole has been inserted in the meantime.

Pole change example

Pole: $X_{\text{Pole}} = 0.0$, $Y_{\text{Pole}} = 0.0$ (Pole 0)
End point:
 $L1_{\text{abs}} = 10.0$ $\varphi_{\text{abs}} = 30.0^\circ$ Calculated Cart. Coordinates
 $X_{\text{abs}} = 8.6603$ $Y_{\text{abs}} = 5.0$

New pole:
 $X_{\text{Pole1}} = 5.0$ $Y_{\text{Pole1}} = 5.0$ (Pole 1)
 Calculated polar coord.
 Predecessor
 $L1_{\text{abs}} = 3.6603$ $\varphi_{\text{abs}} = 0.0^\circ$

Next point:
 $L1_{\text{inc}} = -2.0$ $\varphi_{\text{inc}} = 45.0^\circ$

Absolute polar coordinates for current element
 $L1_{\text{abs}} = 1.6603$ $\varphi_{\text{abs}} = 45.0^\circ$
 Calculate Cartesian coordinates
 $X_{\text{abs}} = 1.1740$ $Y_{\text{abs}} = 1.1740$

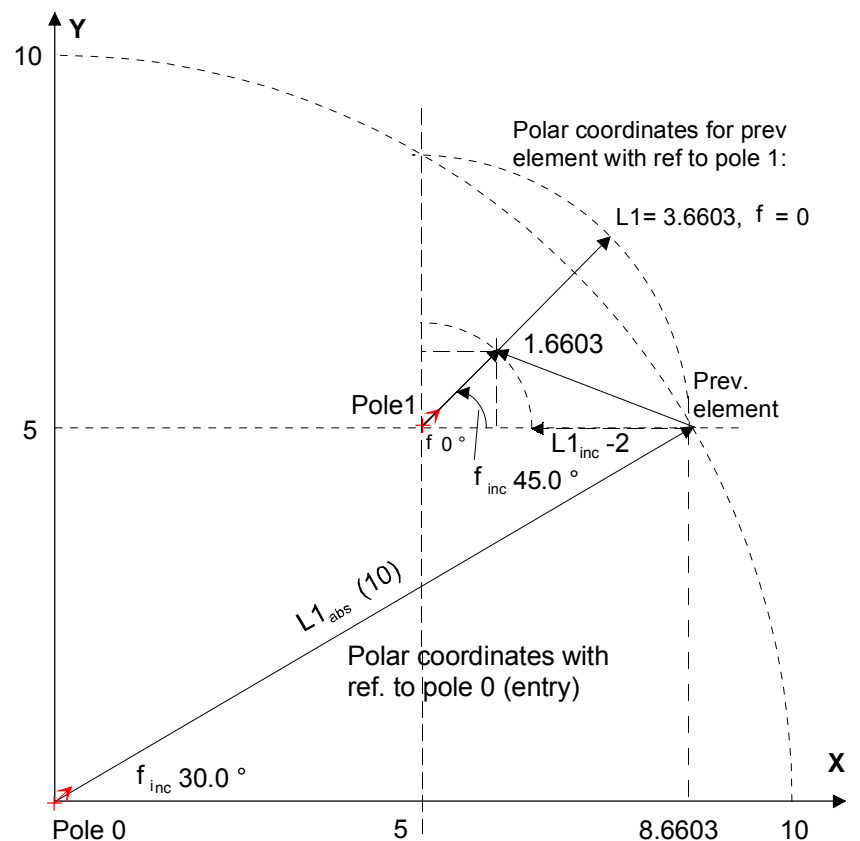

**Example: input circular arc,
polar**

You require a counter-clockwise arc to travel from the starting point X67.5 Y80.211 around the center point I=50, J=50 (according to the pole) and the radius 34.913 to the end point with an absolute polar angle of 200.052 degrees.

The inputs for the circular arc are as follows:

The code created in the part program is as follows:

References

/PG/, Programming Manual Fundamentals: "Programming a circle with polar coordinates"

6.7.7 Support for contour programming



Function

When you input parameters, you can call up a help screen using the Info key which graphically represents the parameters you are entering. The help screen that appears depends on the cursor position in the parameter display.

The help screen is placed over the graphic display.

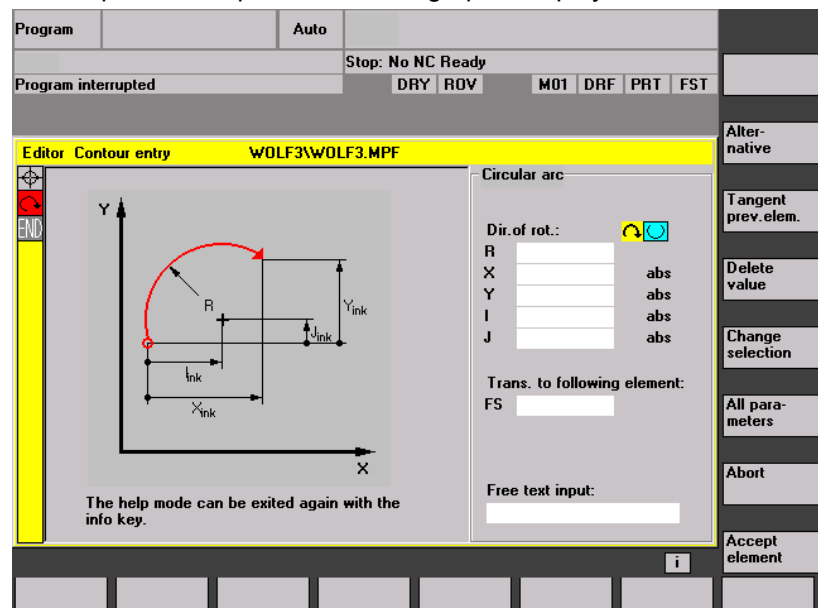

If you press the Info key again the help screen is closed and the graphic display is activated once again. The help screens displayed correspond to the selected coordinate system. The axis identifiers are derived from the current geometry axis names.

Help screens are displayed for the following entries:

- Starting point
- Straight vertical line
- Straight vertical line, angle entry field
- Straight horizontal line
- Straight horizontal line, angle entry field
- Straight line in any direction
- Straight line in any direction, angle entry field
- Circle
- Circle, angle entry field
- Radius/chamfer

6.7.8 Parameter description of the contour elements straight line/circle



Parameters	Contour element "Straight line"
X absolute	Absolute end position in X direction
X incremental	Incremental end position in X direction
Y absolute	Absolute end position in Y direction
Y incremental	Incremental end position in Y direction
L	Length of straight line
$\alpha 1$	Pitch angle with reference to X axis
$\alpha 2$	Angle to preceding element; tangential transition: $\alpha 2=0$
Transition to next element	Transition element to next contour is a chamfer (FS) Transition element to next contour is a radius (R) FS=0 or R=0 means no transition element



Parameters	Contour element "Circle"
X absolute	Absolute end position in X direction
X incremental	Incremental end position in X direction
Y absolute	Absolute end position in Y direction
Y incremental	Incremental end position in Y direction
$\alpha 1$	Starting angle with reference to X axis
$\alpha 2$	Angle to preceding element; tangential transition: $\alpha 2=0$
$\beta 1$	End angle with reference to X axis
$\beta 2$	Angle of aperture of circle
Direction of rotation	In clockwise or counter-clockwise direction
R	Radius of circle
I	Position of circle center point in X direction (abs. or incr.)
J	Position of circle center point in Y direction (abs. or incr.)
Transition to next element	Transition element to next contour is a chamfer (FS) Transition element to next contour is a radius (R) FS=0 or R=0 means no transition element

**Machine manufacturer**

The names of the identifiers (X or Y ...) are defined in the machine data where they can also be changed.

6.7.9 Programming examples for freely programming a contour



Example 1

Starting point: X=5.67 abs., Y=0 abs., machining plane G17
 The contour is programmed in a counter-clockwise direction.

Workpiece drawing of contour

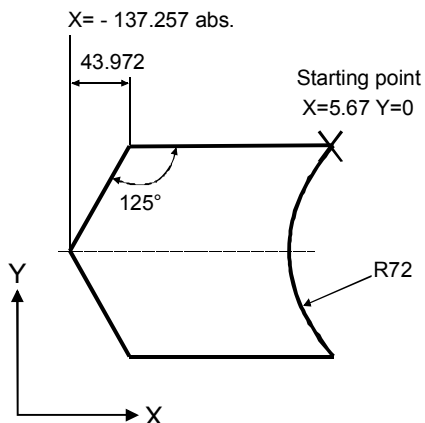

Element	Softkey	Parameters	Comment
1		All parameters, $\alpha 1=180$ degrees	Observe angles in help screen!
2		X= -43.972 inc, all parameters X= -137.257 abs. $\alpha 1= -125$ degree	Definition of coordinates in X in "abs." and in "inc." Observe angles in help screen!
3		X=43.972 inc $\alpha 1= -55$ degree	Definition of coordinates in X in "inc" Observe angles in help screen!
4		X=5.67 abs	
5		Clockwise direction of rotation, R=72, X=5.67 abs..., Y=0 abs..., Select dialog	



Example 2

Starting point: X=0 abs., Y=0 abs., machining plane G17
 The contour is programmed in the clockwise direction with dialog selection.
 For this contour it is advisable to display all parameters via the "All parameters" softkey.

Workpiece drawing of contour

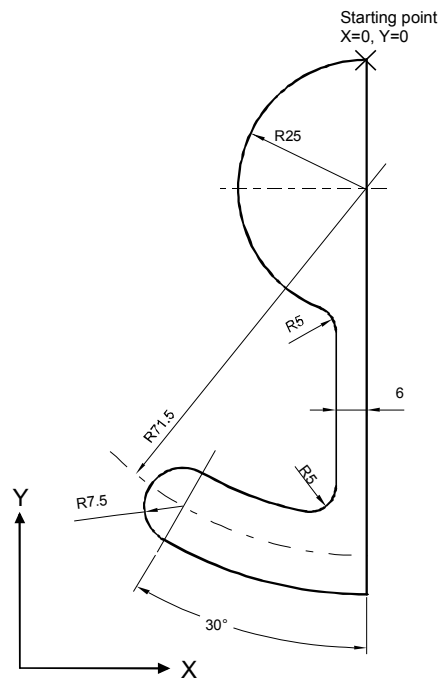

Element	Softkey	Parameters	Comment
1		Y=-104 abs.	
2		Clockwise direction of rotation, R=79, I=0 abs., Select dialog, all parameters, $\beta_2=30$ degrees	
3		Clockwise direction of rotation, tangent to preced. R=7.5, all parameters, $\beta_2=180$ degrees	
4		Counterclockwise direction of rotation, R=64, X=-6 abs., I=0 abs., Make dialog selection, make dialog selection Transition to following element: R=5	
5		All parameters, $\alpha_1=90$ degrees, Transition to following element: R=5	Observe angles in help screen!
6		Clockwise direction of rotation, R=25, X=0 abs., Y=0 abs. I=0 abs., make dialog selection, make dialog selection	

**Example 3**

Starting point: X=0 abs., Y=5.7 abs., machining plane G17
The contour is programmed in a clockwise direction.

Workpiece drawing of contour

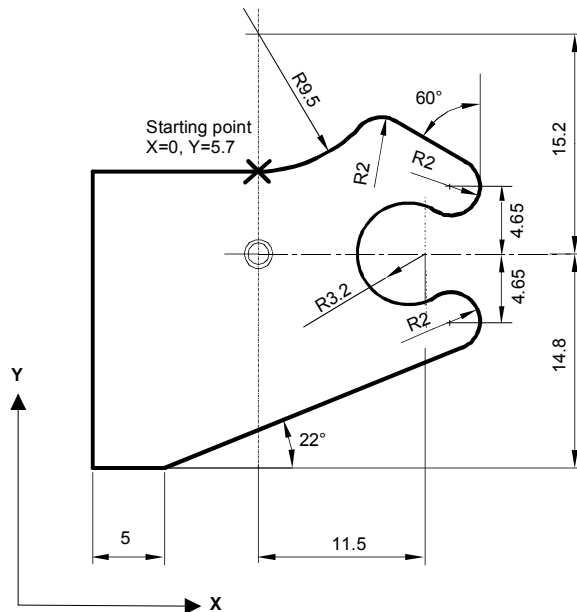

Element	Softkey	Parameters	Comment
1		Counterclockwise direction of rotation, R=9.5, I=0 abs., make dialog selection, Transition to following element: R=2	
2		$\alpha 1 = -30$ degree	Observe angles in help screen!
3		Clockwise direction of rotation, tangent to preced. R=2, J=4.65 abs.	
4		Counterclockwise direction of rotation, tangent to preced. R=3.2, I=11.5 abs., J=0 abs., make dialog selection, make dialog selection	
5		Clockwise direction of rotation, tangent to preced. R=2, J=-4.65 abs., make dialog selection	
6		Tangent to preced. $\alpha 1 = -158$ degrees, Y=-14.8 abs., $\alpha 2 = 0$ degrees	Observe angles in help screen!
7		All parameters, L=5, make dialog selection	
8		Y=5.7 abs.	

6.7 Free contour programming

	9		X=0 abs.	
--	---	---	----------	--

6.7.10 Cycle support



References

Settings

Editor
settings

Setting
contour

The following technologies:

- Drilling
- Milling
- Turning

are provided with additional support in the form of pre-defined cycles, which must then be parameterized.

Programming Guide Cycles

Settings

Define the following values in the "Editor Settings" window:

- Horizontal paging ON/OFF
- Display hidden lines ON/OFF
- Time interval for Automatic Save

When you set Automatic Save, you can also set the time intervals at which text must be saved automatically (applicable only to files on hard disk). If a value $\neq 0$ is entered, the "Save file" softkey is not displayed. If the value 0 is entered, automatic save is not performed.

- Automatic numbering ON/OFF

A new block number is automatically inserted on every new line. If you wish to assign block numbers to an existing program, use the "Renumber" function.

- Number of first block
- Incrementation of block numbers (e.g. 1, 5, 10)

The following settings are possible for contour programming:

- Last line

Each time you complete a program step in contour programming you can insert text in the last line (e.g., "End of contour").

Additional information

- The coordinate system and the technology to be used are set via the machine data; see Commissioning Manual HMI Advanced.
- Edited programs are automatically enabled after saving.

6.8 Program simulation



Function

Simulation Drilling/milling and Complete turning operations

Simulation selection

Graphical simulation is implemented as a self-contained process. The simulation can be selected directly from the program overview or from the ASCII editor after selection of a part program in the "Program" operating area.

Commissioning

You can perform simulation without any special commissioning. The simulation can be started with default data in accordance with the set turning or milling technology.

Using the "Match data" function, selected data can be loaded from NC to the simulation environment and are then available for the simulated programs just like during program execution in the NC.

Providing the correct password is used, additional functions and optimizations (e.g. accelerate simulation run-up) can be performed.

This is described in the Commissioning Manual HMI Advanced, Chapter Match simulation data. In addition, the default values listed in the simulation interface can be adapted to suit the machine manufacturer's requirements.

Technology types

- Drilling/milling
- Complete turning operations
- Workpiece-specific technology assignment through local "DPWP.INI" file

Superimposing principle

The simulation results of several part programs in succession (e.g. for multilateral machining during milling, internal/external machining during turning, multi-slide machining, etc.) can be superimposed on an overall display of the same blank (see machining list in Channel/Spindle softkey). The finished part results from the sequential interaction of all the simulated part programs. **The direct simulation of several part programs (simultaneously) is not possible.**

The range of effectiveness (channel, spindle, tool, sequence) of the currently selected part program is visible in the status line on the lower edge of the simulation window.



ASCII editor link

After deliberate interruptions (simulation STOP or Single-block in the main simulation menu) or on alarms, you can use the "Correct program" softkey to open the program in the editor at the point of interruption. For interruptions within protected cycles the program pointer is positioned at the line with the corresponding subprogram call.

If changes are made in the editor, simulation is returned to the last active section (intermediate model if available).

Additional information

1. The integrity of the simulation data (programs, subprograms, tool data, etc.) is assured by **systematic time-stamp evaluation** for all loading operations.
2. NC language labels (e.g. **WAIT2: WAITM...**) ...) programmed to identify particular points in the program, **can be inserted in the simulation graphic as path labels**. You can simultaneously initiate the generation of intermediate models at these points in the program (see "Manage settings\Display and colors...\Manage path labels").
3. The model used is based on a 3D Cartesian model.
4. The software limit switches are not evaluated during the simulation because no reference point approach is performed. Even an entry in the DPSIM.TEA file is not taken into account.



References

DPSIM.TEA is used to adjust machine data which the user may have defined incorrectly in the INITIAL.INI.

For a detailed description please refer to:

Function Manual Basic Functions, Interactive Programming (D2)

6.8.1 Using the simulation function



Main menu

Sequence of operations

After a program or workpiece is selected, the Simulation softkey is made available.

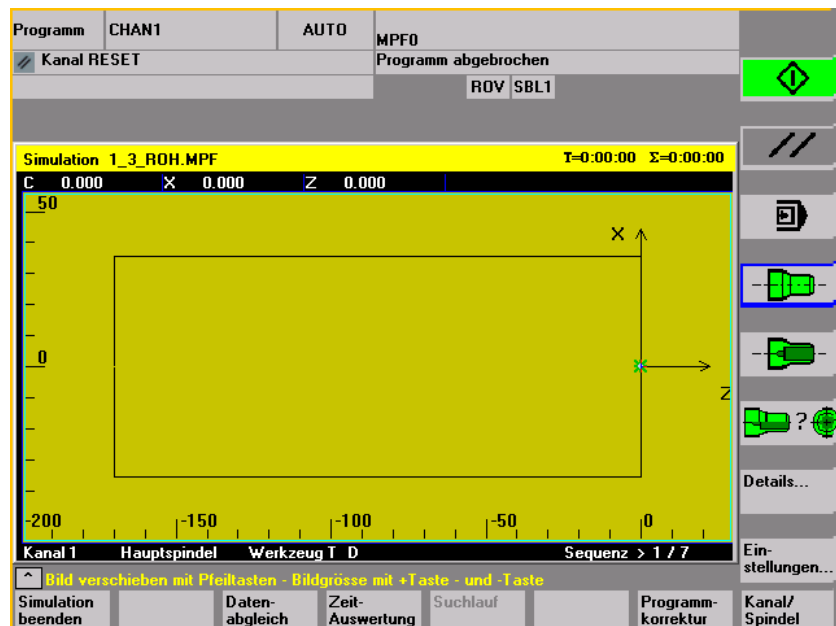

Turning technology main screen

When you select a simulation via a **workpiece**, first the machining list from the Channel/spindle menu (see below) is displayed. Press OK to exit the menus. The main menu is now displayed.

Horizontal main menu

End simulation

Terminate simulation. Return to the program overview or ASCII editor. You need the correct password for this.

Loaded data

Match data

or

With the correct password you can match the simulation data with the corresponding "NC active data" (setup data, tool data, machine data, cycles).

See "Match data" menu

Timing

Tabular evaluation of the execution times for the current simulation session (see Chapter "Downtime settings")

Search run

The function "Search run" can be used to start the simulation selectively for specific sections.

Edit
program

Activate the ASCII editor from the current simulation interruption status (cursor position synchronized with graphic).
Return to simulation with "Close editor"

Channel /
spindle

Program-specific channel and spindle assignments (activate processing list in combination with the overlay principle).
See menu "Channel/spindle"

Vertical main menu



Simulation START or simulation STOP
(program-by-program in conjunction with the machining list)



Simulation RESET
The previous execution result is discarded for the program at hand and a polymarker is displayed.



Simulation single block ON/OFF - SINGLE BLOCK
(status display in header SBL1, SBL2 or SBL3)

Milling

Turning

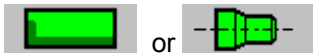

Technology-specific workpiece views

Milling: Top view Turning: External view (front)

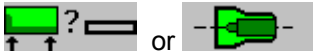

Milling: Default top view Turning: Full section, frontal
and front view
(free selection under "Details...")

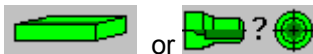

Milling: 3D view Turning: Default half-section, frontal
or wire model Front and wire model
(free selection under
"Details...")

Details

Select status-dependent detail menu (active view, alarm status)

Settings.



Select user and vendor-specific setting menus
in RESET or STOP state or
in RUN state display current simulation override



Notes

1. On simulation START and program change, any 3D view currently displayed is automatically deselected and replaced by a technology-specific default view.
2. If you repeat machining simulation START after end of program M2/M30 of the last program to be simulated, the simulation channels are usually RESET and the simulation graphic reset if no machining list has been activated with the "Channel/spindle" softkey.
3. If the machining list under "Channel/spindle" is activated, the overlay principle takes effect for the listed programs, where global reset in combination with a simulation START is only activated after a query on the last M2/M30.
4. New selection or reselection of one of the listed workpiece views is implicitly linked to automatic screen size adjustment.
5. **In the case of "turning" technology, drills and milling cutters in the G18 plane can only be displayed as polymarkers (cross symbol) in the side views. Only the tool center point path without the tool body is displayed.**

The tool is visible on the front face view (G17) or on peripheral surface processing (G19).

"Details..." menu

Standard horizontal

Assuming 2 window views with no alarm status:

- Default when milling: "Top view and front view"
- Default when turning: "Half-section and wire model"

Milling

Top
view

or

Turning

External
view

Front-
view

or

Half
section

ditto

Side
view

or

Full
section

ditto

Wire
model

or

Wire
model

ditto

Face
end

ditto

Periph.
surface

ditto

With 2 window views only:

Free selection of the different views in window activated by means of



"Details..." menu Standard vertical

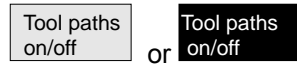

or



Activate/deactivate representation of the tool center point path. Deactivation also deletes any tool paths from the current model that have already been stored (default setting: tool paths on).



With 2 window views only: Select active window. Possible in the same manner with "TAB" or "NEXT WINDOW" (V06.02.13 and higher).

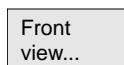

Conditionally with 2 window views: "Front..." depending on type of view active (horizontal selection) same meaning as "from above..." or "from left..."

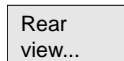

Conditionally with 2 window views: "Rear..." depending on type of view active (horizontal selection) same meaning as "from below..." or "from right..."

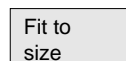

Automatic screen resizing

relative to the window activated with . Also possible with the "ENTER" or "INPUT" key.

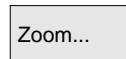

Show window pane border in active window (Size can be altered with "+" - and "-" keys, position can be altered with cursor keys.)



Return to main simulation menu

Menu "Details...." 3D vertical



"3D view" (3D with tool data) for milling, not effective for turning simulation

Standard 3D view, orientation top/front



3D view, orientation top/left, rotated clockwise by 90 °.



3D view, orientation top/right, rotated clockwise by 90 °.



3D view, orientation bottom/front, inclined towards top

Fit to
size

Automatic screen size adaptation
Also possible using the "ENTER" or "INPUT" key.

Zoom...

Show window pane border in active window
(Size can be altered with "+" - and "-" keys, position can be altered
with cursor keys.)

<<

Return to main simulation menu

Menu Alarm "Details..." vertical

Assuming an alarm status during simulation,
independent of the view currently active



Reset POWER ON alarms of simulation. The simulation is terminated
and loaded again.



Reset RESET alarms of simulation. The simulation interpreter is reset.
The simulation can be started again.



Reset CANCEL alarms of simulation. The simulation can be
continued.

End
simulation

The simulation process is terminated. A load operation is necessary
before the simulation is selected again.

Details
view...

Open the menu bar corresponding to the active workpiece view
"Details..." (standard or 3D) from the alarm state. The simulation
alarms remain active.

<<

Return to main simulation menu

Additional information

1. **Simulation alarms are only messages of the simulation interpreter and have no direct association with the current NCK machining status on the machine tool.**
2. If more than one simulation alarm is pending, you can show or hide the complete alarm list with the "toggle" key. You can select an alarm with the "cursor" keys.
3. If you press the information key "i" the online help with an explanation of the selected alarm is displayed.</F>
4. Program sequences which cannot be interpreted in simulation contexts only and only then trigger an alarm (e.g. in user cycles because the relevant PLC data and signals are not available in the

simulation interpreter), must be **jumped conditionally** in the corresponding NC program with **evaluation of system variable \$P_SIM during the simulation** (..IF \$P_SIM GOTOF label). The components relevant to simulation (e.g. tool change position and M switching functions for tool change in tool change cycles, etc. cannot be skipped, they must be executed.

5. The simulation does not evaluate events set by MD 20108, which lead to program activation.

Menu "Match data" vertical

Loaded
data

Correct password and NC components are prerequisite for using Match data to load data selected in the NC to the simulation environment. The data is then available for the simulated programs just like during program execution in the NC.
(Matched data see data management \DP.DIR\SIM.DIR)

The loaded files are displayed.

User programs, user cycles, standard cycles, manufacturer cycles and base data.

Compare
setup data

The selected data is loaded into the simulation environment from the NC.

After editing NC data, a new data synchronization operation must be performed.

On the other hand, the response of the NC to modified data can be simulated in advance by editing the data within the simulation environment.

Compare
tools

The tool data for all channels is loaded to the simulation environment and copied to the file TO_INI.INI.

Compare
mach. data

The machine data and active definition files are loaded to the simulation environment and copied to the file INITIAL.INI.

Compare
cycles

The cycles which have already been loaded into the simulation are replaced by cycles with more recent time stamps.

<<

Return to main simulation menu.

Additional information

1. If no Match data operation has yet taken place (and the NCK component is installed), a request is automatically issued in the form of a message when the simulation is initialized. The user is automatically informed of modifications to tool data.
2. The working cycles are loaded from the part program **once on the first call** and remain active for all subsequent simulation sessions.
3. With the "Match cycles" softkey you can load updated cycles with a new timestamp into the simulation. Cycles with access protection are always reloaded, irrespective of the timestamp. The Match data process only needs to be repeated if changes have been made to the cycles.
4. It is recommended to set MD11210=0 "Match all machine data".

"Channel/spindle" menu vertical

Channel /
spindle

Only accessible from RESET or STOP status.

The screen shows the current **execution list** for the selected part programs.



Programm	CHAN1	AUTO	MPF0				
Kanal RESET			Programm abgebrochen			Einstellung Kanäle	
			ROV SBL1				
Kanal/Spindel: INDEX_2_G400_A2032620							Einstellung Spindel
Sequenz	Programm-Name	Start-Label	Stopp-Label	Kanal	Spindel	aus	
1	1_3_ROH.MPF			1	HS	<input type="checkbox"/>	Kopieren
2	3_0.MPF		WM15:	3	HS	<input type="checkbox"/>	
3	1_0.MPF		WM15:	1	HS	<input type="checkbox"/>	Einfügen
4	3_0.MPF	WM15:	WM20:	3	HS	<input type="checkbox"/>	
5	1_0.MPF	WM15:	WM20:	1	HS	<input type="checkbox"/>	Löschen
6	3_0.MPF	WM20:		3	HS	<input type="checkbox"/>	
7	1_0.MPF	WM20:		1	HS	<input type="checkbox"/>	Fertigteil
Hinweis : Mit 'Ok' wird das erste Programm angewählt und ein Reset ausgelöst.							Abbruch
Mit Pfeiltaste Element auswählen , Kanäle : (+/-) 1, 2, 3, 6							OK
Programm- auswahl							

Sequence

Simulation sequence of programs

Program name

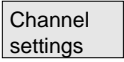
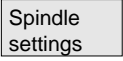
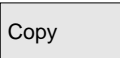
List of programs

Start label		Path label from which a program is simulated. If this is not specified, simulation takes place from program start.
Stop label		Path label up to which a program is simulated. If this is not specified, simulation takes place to program end. (See also "Multi-channel, section by section program simulation".)
Channel		Processing channel in the SIMNCK interpreter
Spindle		Turning: MS main spindle, CS counterspindle, var variable controlled via NC vocabulary word. (Milling: currently unused)
Off		Skipping The designated section/program is not simulated in the current session.
		Leads to the manufacturer-specific channel settings (subject to correct password).
Milling		Constant machine arrangement
Turning		Machine arrangement in front or behind turning center.
		Leads to the manufacturer-specific spindle settings (subject to correct password). currently unused
Milling		
Drehen		Defines longitudinal offset for main spindle and counterspindle, longitudinal mirroring on/off, NC keyword definitions for spindle switchover.
		Copy selected line of machining list to clipboard.
		Insert the machining list line that was copied/deleted from the clipboard at the position of the selected line (the selected line is moved down one row).
		Delete the selected line from the machining list

Abort

Return to main simulation menu: Modifications to the current machining list are not saved

OK

Return to main simulation menu: Modifications to the current machining list are saved and activated with the information displayed

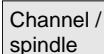
Channel /
spindle

Additional information

1. **To activate the machining list after a workpiece selection, it must be selected explicitly at least once with the "Channel/spindle" softkey.**

The list is displayed implicitly every time a program is subsequently selected from the same workpiece directory so that it can be added to as required. It only makes sense to define a simulation sequence using the machining list "Channel/spindle" provided if the overlay principle for part machining is used (i.e., when the simulation result of several part programs in succession is to be viewed at a single blank). In such cases, it is especially important to also follow the instructions at the bottom of the dialog. These may contain lines for which an intermediate model has already been created, a special status display. By selecting such a line in the machining list you can place the simulation directly on the associated intermediate model again.

2. If individual programs are simulated, the machining list default produces the correct simulation sequence even if the menu item "Channel/spindle" is not selected (and therefore without applying the overlay principle).
3. With the correct password you can define manufacturer-specific default setting values with "Change default" under menu items "Channel settings" and "Spindle settings", which then apply **globally for all new workpieces.**

6.8.2 Simulation settings

"Settings..." menu

Only accessible from the RESET or STOP state of the simulation (e.g., single block mode)

Other settings can only be displayed/hidden if you enter a valid password via the "Options" softkey.

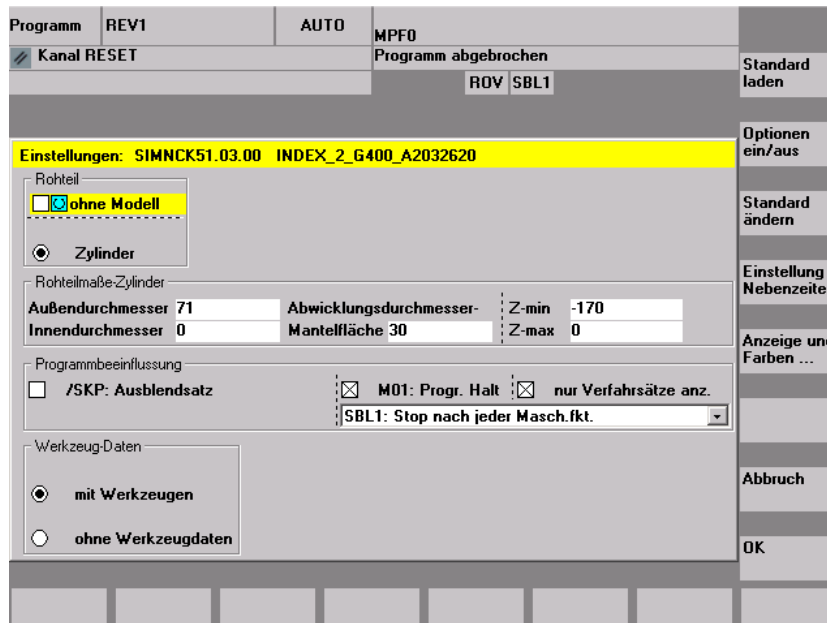

Load standard

Load manufacturer-specific default settings (See data management: \DP.DIR\SIM.DIR\SIMINI_M.COM for milling or SIMINI_T.COM for turning and differential files in the \USER directory).

Options on/off

or

Options on/off

Display/hide optional setting parameters in the current window, (Initial setting is options off)

Change default

The default values can be modified according to the manufacturer's requirements if a valid password is entered. The changes to the manufacturer-specific default set values in files "SIMINI_M.COM" and "SIMINI_T.COM" are used as differential parameters in the files "DPMWP.INI" and "DPTWP.INI" in the \USER directory and taken into account for all **new workpieces**.

Downtime settings

With the correct password, you can set the desired computation mode for secondary times and selectively define estimated secondary times for the NC functions T, S, M and H.

Settable parameters: See Chapter "Downtime settings"

The input screen has been changed to enable selection between the machine data and an individual tool change time (as previously).

If the machine data 10190 (\$MN_TOOL_CHANGE_TIME) is set and greater than 0, the "Downtime setting" offers a range of options via additional buttons:

The user can either enter an individual time for the tool change or select the displayed value for the machine data.

The default is the value entered by the user. This can be preset via the entry in the file SIMINI_T.COM (for turning) or SIMINI_M.COM (for milling) in the \DP.DIR\SIM.DIR data manager.

```
[Sim]
DP_SIMNCK_MD10190=0
;Default: value 0 = tool change time is set by user
                    (see DP_SIMNCK_TOOLCHANGETIME)
;                    1 = tool change time from MD10190
                    ($MN_TOOL_CHANGE_TIME)
```

If MD10190 is not set or the value is equal to 0, the formula remains as it was previously.

Display and
colors...

The specified display and color properties for the simulation can be modified according to the manufacturer's requirements if a valid password is entered.

Settable parameters: See Chapter "Display and colors"

Abort

Return to main simulation menu. The old settings before the setting screen was selected are retained.

OK

Return to main simulation menu. The modified settings are saved and activated immediately.

Basic "Settings..."

Blank

- **Milling:** without model (display area), cuboid (blank dimension cuboid), cylinder (blank dimension cylinder).
- **Turning:** without model (display area), cylinder (blank dimension cylinder) and active processing diameter for peripheral surface.

Active view

- **Milling:** X-Y, Z-X, Y-Z (for "Cuboid" and "Without model" only)
- **Turning:** Z-X always defined, cannot be changed

Blank dimension cuboid

- Minimum and maximum dimensions for each axis

Program control

- SKP: Skip blocks (10 skip levels are available)
- M01: Programmed STOP 1 or
- M101: Programmed STOP 2 taken into account
- Single block mode:
 - SBL1: Stop after each machine function
 - SBL2: Stop after each block
 - SBL3: Stop in cycle
- Display all blocks or only traversing blocks

Tool data (source) NC active data

The tool offsets are used in accordance with the active NC (Match tool data \TO_INI.INI) and the tool path is simulated with graphic tools. With technology turning the cutter radius is not modeled. The tool radius compensation is evaluated. Tools that are not interpreted are displayed as polymarkers.

With tool

HMI data, local TOA data, global SPF file, tool match data from data management \DP.DIR\SIM.DIR\TO_INI.INI

Default tools

Evaluation only with milling/drilling if no TO_INI.INI (Match tool data) is present and tool management option not active. The tool diameter can be parameterized (providing access is enabled via a valid password) if ON is activated under the Options settings. The tool radius compensation is evaluated.

Without tool data

The tool path is simulated with a polymarker. No evaluation of tool radius compensation i.e. broken-line graphics with compensation value D0.

Additional information

1. In order to reduce the input effort when the blank type is repeatedly changed, the blank dimensions and the display area are compared internally when the settings are saved.
2. A suitable image of the NC-active data INITIAL.INI and TO_INI.INI under DH\DP.DIR\SIM.DIR is required for simulation with the option "Tool monitoring". Default settings for the tool management are taken from the supplementary tool data `..\mmc2\dp\sim\to_addon.ini`. Tools which are not loaded in the active magazine image (from TO_INI.INI) can therefore be called during simulation if necessary.
3. In simulation "without tool data", using standard cycles results in the representation of the final contour derived from the available cycle parameters.
4. Simulation "without model" and/or "without tool data" both limits the required graphic memory and increases the simulation speed.

Optional "Settings..."

Options
on/off

Other settings can only be displayed/hidden if you enter a valid password via the Options softkey.

Depths for color classification

Depth range across which the available VGA system colors for displaying depth information are distributed (default range = blank thickness).

The rounding inaccuracy in defining depth of color is 10^{-3} units.

Default values

- Tool diameter: Tool diameter used for milling simulation with default tool (end mill/drill).
- IPO mm or inch: Approximation precision of simulation interpolator in mm or inches depends on actual measuring system.
- F override %. Setting the simulation feed
% setting options: %1 to %500 (from V06.12.13 < 10 %)
- Increment of 10 with "+" or "-" key
- Increment of 50 with "Cursor right" or "Cursor left"
- Max/Min value with "Cursor up" or "Cursor down".
- Default value 100 with "Toggle" key

Display options

- Actual position: Display hide actual value of simulated channel axes (Note: TRANS, ROT, SCALE and MIRROR are not taken into account in the actual value display).
- NC block: Activate/deactivate display of current NC block
- Machining time: Activate/deactivate display of the calculated machining time in the header of the basic simulation window (T = calculated machining time (from the programmed feedrates) = machining time + sum of all estimated down times).

Simulation mode

- Always reload tools
 - * In position "on" (default setting), all the necessary tool data are reloaded on each program change.
 - * In position "off", tool data are only reloaded if required, if the timestamp is altered (automatic query). Otherwise, the existing tool environment is not changed.
- Save tool path
 - * In position "on" (default setting), all the tool paths in the simulation sequence are visualized and stored temporarily in the model for future display (zoom, etc.).
 - * In position "off", the resulting tool paths are visualized once and not stored temporarily in the model. When the display is subsequently manipulated (e.g., Zoom +), the tool paths are lost.
- Block-by-block processing
 - * In position "on", discontinuous path processing, but largely accelerated (reduced number of IPO interpolation points, for example, only at block end points on straight lines).
 - * In position "off" (default setting), largely continuous path processing (constant distance between interpolation points depending on the IPO setting).
- Waiting for dwell times
 - * In position "on", program instructions with dwell times cause real dwell times in the simulation.
 - * In position "off" (default setting), the dwell is suppressed in the simulation and the dwell times are only taken into account in time calculations.

Additional information

1. Changes to the blank dimensions in the infeed axis (min or max) are automatically traced in the depths for color separation (min or max).
2. High values for the interpolator approximation accuracy cause increased distortion of the geometry representation (e.g. in details and rounded sections), but also reduce the amount of graphics memory required and increase the speed of the simulation.

Recommended settings

3. Recommended setting for group "simulation mode":
 - .. in production
 - Always reload tool "off" and store tool path "off"
 - Block by block preparation "on" and wait with dwell times "off"
 - .. in program mode (default setting)
 - Always reload tool "on" and store tool path "on"
 - Block by block preparation "off" and wait with dwell times "off"
 - .. In training operation
 - Always reload tool "on" and store tool path "on"
 - Block by block preparation "off" and wait with dwell times "on"
4. The following settings are recommended for demonstrations with endless program loops (accelerated execution of simulation with reduced demands on the graphic memory):
 - Always reload tool "off" and store tool path "off"
 - Block by block preparation "on" and wait with dwell times "off"

and additionally:

- Blank "without model" (no memory used for graphic!)
- Or "without tool data", if representation of the tool center-point path (broken-line graphics) is sufficient.

If the blank model is active ("cuboid", "cylinder"), reduced graphic memory capacity might result, which, depending on the complexity of the part and model resolution set, could exhaust the graphic memory despite the save tool path setting "OFF".

6.8.3 Setting downtimes

<p>Timing mode</p> <p>Settings.</p> <p>Downtime settings</p> <p>OFF (default setting)</p> <p>Per program</p> <p>Per section with labels</p> <p>Inclusion</p> <p>Tool change ON/OFF</p> <p>Spindles ON/OFF</p> <p>M functions ON/OFF</p> <p>H functions ON/OFF</p> <p>Settings.</p> <p>Load standard</p> <p>Change default</p>	<p>Setting timing for downtimes:</p> <p>Central timing does not include fixed downtimes or the processing of information for tabular "Time analysis".</p> <p>Central timing includes the elements listed in "Inclusion on" in the downtime analysis. The tabular "Time computation" is processed once per program in each case with M30, for example.</p> <p>Effect as for "per program", only that processing of the tabular "time computation" is also performed when freely definable program labels occur or in combination with the path labels displayed in the simulation graphic (see ..\ Display and colors...\ Manage path labels).</p> <p>Enabling and setting of fixed downtimes in seconds</p> <p>- Definition of a fixed downtime for tool changes</p> <p>- Definition of a fixed downtime for main spindle and secondary spindle instructions</p> <p>- Definition of a fixed downtime for M functions</p> <p>- Definition of a fixed downtime for H functions</p> <p>Additional information</p> <p>The default values can be modified according to the manufacturer's requirements if a valid password is entered. The new values are then globally valid for all new workpieces.</p>
--	---

6.8.4 Display and colors

General attributes

Setting the general properties of the simulation graphics:

Settings.

Display and colors...

Rapid traverse dashed line Alternatively, rapid traverse as a full line, as used for feedrate

Scale at edge of window Alternatively, as scale on the coordinate axes

Path labels

Offers various possibilities under "Manage path labels" for displaying **program labels**, which have been inserted freely to identify specific points **in the NC program** (observe label syntax), **as path labels** at the corresponding point in the simulation graphics and then storing the associated **graphic model** in the buffer.

Program labels can also be used to mark program sections, which can then be included by the central timing facility (see .. \ Downtime settings \ Timing mode \ In sections with labels).

Path labels are specified in "Channel/spindle" as delimiter for section-by-section simulation in the same or different channels.

You can save section models and use a **search run** to start again at that point without needing to repeat the preceding sections.

Use of color palettes

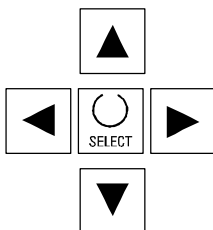

- Select a color with the cursor keys and press the Select key. The color of the focus frame changes.

- Use the cursor keys to select the object and press the Select key again. The object displays the selected color..

General colors

In addition to the standard VGA colors, the color elements black and transparent to hide graphic elements are available in the color palette. Color selection option for **background, blank, axis intersection, tool holder** and **tool edge**.

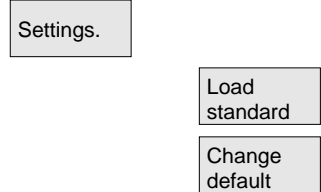
<p>Color palettes for tool path</p>	<p>Two freely definable color palettes are available for tool paths for differentiating between feedrate and rapid traverse movements. In each color palette it is possible to differentiate between different basic tool types (without tools, drilling tools, milling tools, turning tools, threading tools, special tools), to allow differentiation for path visualization.</p>
<p>Channel assignment of color palettes</p>	<p>One of the two tool type specific color palettes can be freely assigned to each of the required simulation channels.</p>
<p>Planes for color classification</p>	<p>In the case of milling/drilling, the available colors are assigned to the defined cutting depth range. The default value is the thickness of the blank.</p>
	<p>Additional information</p> <p>The default values can be modified according to the manufacturer's requirements if a valid password is entered. The new values are then globally valid for all new workpieces.</p>

6.8.5 Section-by-section simulation



Function

A procedure in which first the individual sections of a program are optimized one after the other without collision consideration is the preferred method for testing part programs graphically. Section by section simulation allows the user to go to the individual section of the program via reference points (using block search).

The reference points are always defined by path markers (program labels).

Settings.

Display and
colors...

Search run

Prerequisite:

- In order to manage path markers (program labels, e.g. MARKER1), they must be programmed at the required position in the program.
- Using the "Manage path markers" setting (Settings -> Display/Colors -> Manage path markers) you can decide whether
 - the path markers are to be displayed in the graphic and/or
 - the associated intermediate model is to be saved.

Intermediate stages of the simulation model can be stored next to the path markers, allowing synchronized resumption of simulation without resetting the graphic that already exists.

You can skip any sections that are already optimized.

Block search:

In the menu "Block search" you can select the path marker you wish to jump to.

Additional information

- You can also load the machining list in menu "Channel/spindle" directly from the current workpiece via the "Program selection" softkey or from a JOB list.

6.8.6 Quick display in the simulation for mold making

Target

The function offers quick display of machining paths, e.g. like those used by CAD systems. Generally these part programs are very large.

Any existing work offsets, Go, G2, G3 are not taken into account, only those **axis paths resulting from G1** are displayed.

Characteristics of quick display

- Simulation for mold making is a standard function
- Switching between 2D and 3D is supported
- Rotation of workpiece in 3D view
- Representation in the various different planes
- Size scaling, zoom for the displayed workpiece
- Search via row number/string
- Search via machining block which traverses marked positions
- Progress bar
- Execution of part program blocks
- Distance measurement
- Can be interrupted by other operating areas/can be aborted
- The programs to be simulated can be executed from external drives
- The NC interpreter does not take part in the simulation.

Activating

Operation for mold making simulation is available in the Program operating area if display machine data 9480:

MA_SIMULATION_MODE is set to a value between 0 and 2.

-1 Standard simulation

0 Selection between standard simulation/mold making G1 blocks
via operation

1 Mold making only, G1 blocks

2 Automatic mode selection via program size.

The limit value for the program size is specified in the display Machine data 9481: MA_STAND_SIMULATION_LIMIT.

Size scaling

The following scaling settings are available: **Zoom in**, **Zoom out** and **Automatic fit window**.

The automatic scaling function "Fit to size" uses the part program to take the largest expansion of the workpiece in the individual axes into account.

Search

In the submenu **Details**, the search function displays the part program block whose machining path traverses the **position** (which was previously marked using the cursor keys or softkeys) in the workpiece representation.

First activate **Block search** then use the cursor keys or softkeys to move the cross-hair to the desired location. Press the input key to search for the required block and display it. The cross-hair must be positioned in the area of the displayed workpiece section.

In the submenu **Edit** you can choose whether to search for a block designated by a **block number** or a block which contains a specified **string**.

The search function will return the blocks that match the criteria and display them in the 2-line program section above the graphic display and highlight them.

Progress bar

The message line shows the percentage value of the entire part program which is displayed in the graphic.

Loading the workpiece graphic can be cancelled at any time by pressing the **End** softkey. Changing to a different operating area interrupts loading the graphic. When you return to the Program operating area, the loading process is continued.

Rotation

In 3D representation the displayed workpiece can be rotated around any of the axes. The rotation instructions become active after you press **Accept** to confirm.

Distance measurement

In the graphic display you can use the **Mark point A** and **Mark point B** softkeys to enter two markers at the positions you have set via the cursor keys. The direct path (space diagonal) between the points is output in the message line.

6.8.7 Simulation with external network drive

**Function**

With the SINDNC software, you can link your control to external network drives or other computers and use this facility for program simulation. It is possible to access files on network drives from a part program using the EXTCALL command.

- With EXTCALL, the drives in the network are also searched for subprograms (SPF only) if the program is called without a path. Subdirectories are not searched. The program will also be found if the search range is defined with the variable \$SC_EXT_PROG_PATH or if a path to a file in the network - even in a subdirectory - has been defined.
- Programs in the network drives (with the extension MPF and SPF) can be simulated.
- If write access is set for a network drive, file DPWP.INI is created and the current directory is treated like a workpiece.
- If write access has not been set, a DPWP.INI is created for each network drive in the TEMP directory of the HMI irrespective of the current directory. In this case, the simulation settings are lost when the directory on the drive is changed.

6.8.8 Simulation for orientable toolholder



Function

You can process part programs for orientable toolholders using the simulation function. The following boundary conditions must be observed:

- The simulation distinguishes whether a toolholder Y has been activated for a tool x.
- Changes in the active toolholder are not detected. This is why the simulation uses the toolholder kinematic set initially for a tool y.
- Changes made after first activation (TCARR=x) are not considered.
- To use several toolholder kinematics for one tool y, create several identical tools with different toolholder settings.
- Inactive files are grayed out.

6.9 Managing programs



Function

To allow you to handle data and programs flexibly, you can organize, store and display them according to different criteria.

The memory is divided into:

- NC memory (main memory and program memory) containing the active system and user programs as well as all part programs for immediate execution and
- Hard disk

Programs can be exchanged between the program memory and hard disk.

Part programs may be stored either in the program memory of the NC or on the hard disk, but they are always executed from the program memory.

The "Load" and "Unload" functions are used to load or unload programs to or from the program memory (see Chapter 9.3 NC).

Program management

The programs and files are stored in different directories and can be administered in the Program and Services operating areas. The details are shown in the following overview:

Name of directories: Operating area:

- Subprograms Programs and Services
- Part programs Programs and Services
- Workpieces Programs and Services
- Definitions Services
- Comments Services
- Standard cycles Programs and Services
- Manufacturer cycles Programs and Services
- User cycles Programs and Services

The following diagram shows an example of directory contents:

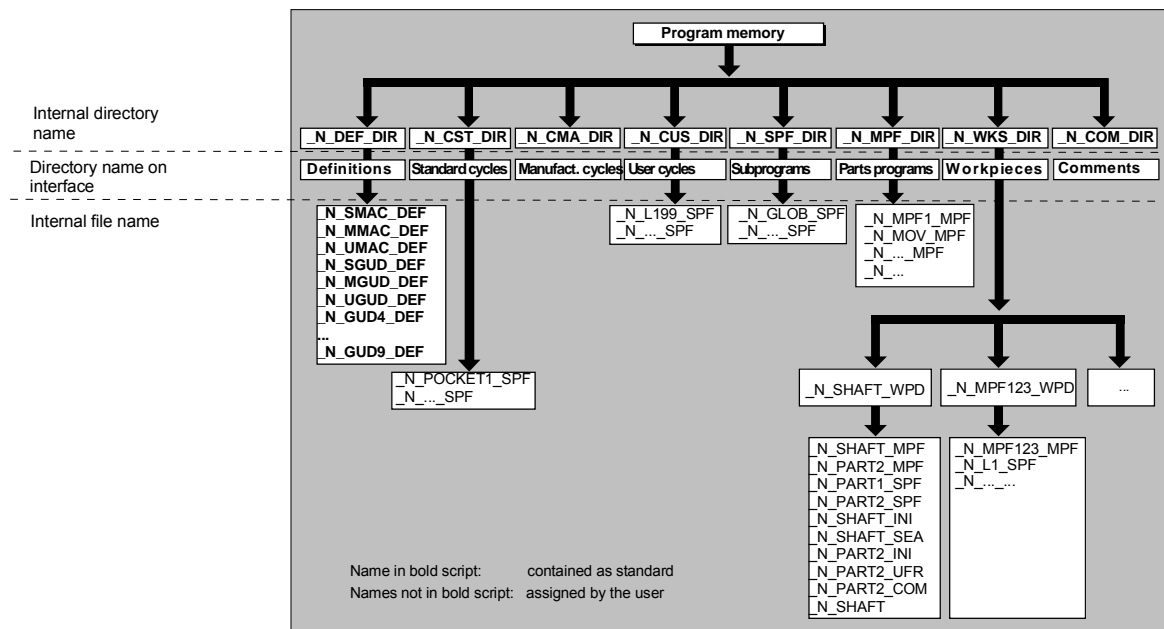

NC data types and directories

File types can be identified by the file name extension (e.g. .MPF).

name .MPF	Main program
name .SPF	Subprogram
name .TEA	Machine data
name .SEA	Setting data
name .TOA	Tool offsets
name .UFR	Zero offsets/frames
name .INI	Initialization file
name .COM	Comment
name .DEF	Definition of global user data and Macros



Please note that on the directories:
comments \COM.DIR and definitions \DEF.DIR can only be
accessed in the Services operating area via "Manage data".

6.9.1 New workpiece/part program



Function

The following subsection describes how you can select workpieces
and part programs in a directory. A selected file can then be called
and edited in the text editor.



Sequence of operations

Select workpiece/part program:

- Workpieces
- Part programs
- Subprograms
- User cycles
- Clipboard

Work-
pieces

Part
programs

Sub-
programs

User
cycles

Clipboard

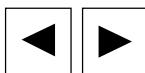

Position the cursor in the directory on the desired file. For each file,
the file name, file type, length, date of creation/last change are
displayed.

You can change the properties of the file display (see Section
"Commissioning", "Settings" menu)



Call a part program:

Use the cursor to select a program in the program overview and press
the "Input" key.

The text editor is displayed with the file you have selected.

You can now edit the part program.



Open workpiece:

The workpiece directory is opened and the programs it contains displayed on the screen.



Create workpiece directory

You can set up various types of files such as main programs, initialization files, tool offsets, etc. in the new workpiece directory.



Sequence of operations

Workpieces

The current overview of all workpiece directories appears on the screen.

New

Input window "New" is opened.

The cursor is located in the input field for the name of the new workpiece directory.

Enter the name of the new directory on the alphanumeric keyboard. Specify the created type in the data type field: WPF

If there are any templates for the specified data type in the Templates directory they are offered for selection. Press OK to confirm your selection.

A new directory is set up in the workpiece overview.

You are asked straight away for the name of the first part program and the Editor is opened.

When creating a workpiece with **New**, all **templates** corresponding to your selection are only copied from the Templates\Siemens ... Manufacturer ... User directory to Commissioning\Settings\Templates if "**No template**" is selected in the Templates selection field.

If a template is proposed for the workpiece, then all elements assigned to it such as job list, part program, subprograms are transferred to the new workpiece in compliance with the template and its language-specific elements.

6.9.2 Create programs/data in a workpiece directory

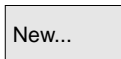

Function

This section explains how you can create a new file for a part program or workpiece.

Sequence of operations

The current overview of the workpiece directories stored on the NC appears.

Position the cursor on the required workpiece and open it.

An overview will be displayed listing the data and programs that have already been created in the workpiece directory. If no data is available, the program overview is blank.

A dialog box appears when you press the "New" softkey. Enter the new file name.

You can also enter the corresponding file type using the "Insert key". For instance, the following file types are possible:

File type	Significance
.041	AutoTurn program
.CEC	Sag/angularity
.COM	Comment
.DAT	MCSP data
.GUD	Channel user data (Global User Data)
.IKA	Compensation data
.INI	Initialization program
.JOB	Job list
.MPF	Part program (main program file)
.PRO	Protection zones
.RPA	Arithmetic parameters
.SEA	Addresses with value value assignments (Setting Data Active)
.SPF	Subprogram (subprogram file)
.TCM	Tool plan reformatted (for SINTDI)
.TEA	Machine data (testing data active)
.TMA	Magazine data (Tool Magazine Active)
.TOA	Tool offsets (tool offset active)
.UFR	Work offset (Frame)
.WPD	Workpiece (Workpiece Data)

Part programs or Sub-programs

New...



Number of workpieces

Create part programs in the part program/subprogram directory:

You can set up main programs and subprograms by opening directories "Part programs" and "Subprograms".

Press the "New" softkey to display a dialog window in which you can enter the names of the new main programs and subprograms. The matching file type is automatically assigned in this case.

- A maximum of 100,000 files can be stored in the data manager.
- The number of files per directory must not exceed 1,000 (or per workpiece directory for workpieces *.WPD).
- The maximum size of editable files is 56 MB.

6.9.3 Saving setup data



Function

With the "Save setup data" softkey, you can store all the active data belonging to a particular workpiece located in the working memory of the NC.

The data are stored for each channel under the same name under a workpiece.



Additional information

"Save setup data" can be disabled by the manufacturer using the protection levels.



Sequence of operations

Workpieces

The current overview of all workpiece directories appears on the screen.



Place the cursor on the workpiece directory or workpiece in which you want to store the workpiece-specific data.

Save setup data

The input window "Store workpiece data" is opened when you select "Save setup data".

In this input window you can select the workpiece data that you wish to save.



E.g., you can select the following data types:

- R parameters (RPA)
- Work offset (UFR)
- Setting data (SEA)
- ...

If a job list exists, it is used as the basis for the save procedure.

With the "Save" softkey, you store the workpiece data of the selected data types in the relevant workpiece directory.



If a job list exists in this workpiece directory, the data for all the channels involved in the workpiece are automatically backed up. For this, the main program selected at the beginning is searched for each channel in the job list. The data are then backed up according to the data types selected under its name.

With the „Load Standard softkey you can load the default settings for input window "Save workpiece data".

Note:

Default settings are always supplied by SIEMENS.



Press this softkey if you want to define your own defaults in the input window.

6.9.4 Selecting a program to be executed



Function

Workpieces and part programs must be selected for machining/execution before you press the NC Start key.



Sequence of operations

Select a program:

Use the cursor keys to select a program in the

program overview, e.g., part programs, and

then press the "Selection" softkey.

The program name is displayed in the "Program name" window at the top right.

You can start the part program by pressing "NC Start".

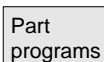



Work-
pieces

Selection



Selection

Find path for program call

Select a workpiece:

A workpiece directory can be selected for machining in the currently active channel.

Use the cursor keys to select the workpiece

in the workpiece overview and then

press the "Selection" softkey.

- If only one main program (MPF) exists in this directory, it is automatically selected for execution. If the directory contains several main programs, the main program with the same name as the directory is automatically selected for execution (e.g. if you select workpiece `SHAFT.WPD` main program `SHAFT.MPF` is automatically selected).

The program name is output along with workpiece information in the "Program name" window at the top right.

You can start the part program you have selected by pressing the "NC Start" key.

- If an INI file of the same name exists (e.g., `SHAFT.INI`), it will be executed once at the first part program start after selection of the part program. Any additional INI files are executed in accordance with machine data 11280 `$MN_WPD_INI_MODE`.

When you select workpiece directory `SHAFT.WPD` you implicitly select program `SHAFT`.

If a `.JOB` file with the same name is stored in the workpiece directory, it is executed immediately.

See also Chapter "Job list" and "Sequence of operations" "Executing job list".

If the call path is not explicitly specified in the part program when a subprogram (or an initialization file) is called, the called program is located according to the predefined search strategy.

Case 1: When a subprogram is called by name **with specification of the data type** ("identifier" or "extension"), e.g. `SHAFT1.MPF`

the system searches through the directories in the following sequence:

1. Current directory / name.type Workpiece/standard
directory `MPF.DIR`
2. /SPF.DIR / name.type Global subprograms

3. /CUS.DIR / name.type User cycles
4. /CMA.DIR / name.type Manufacturer cycles
5. /CST.DIR / name.type Standard cycles

Case 2: When a subprogram is called by name **without specification of the data type** ("identifier" or "extension"),
e.g. SHAFT1

the system searches through the directories in the following sequence:

1. Current directory / name Workpiece/standard
directory MPF.DIR
2. Current directory / name.SPF
3. Current directory / name.MPF
4. /SPF.DIR / name.SPF Subprograms
5. /CUS.DIR / name.SPF User cycles
6. /CMA.DIR / name.SPF Manufacturer cycles
7. /CST.DIR / name.SPF Standard cycles



References

/PGA/, Programming Guide Advanced



Machine manufacturer

see the machine manufacturer's information.

Preconditions:

- A main program (MPF) in the workpiece directory is selected

"NC Start" was activated

\$MN_WPD_INI_MODE=0:

The INI file with the same name as the selected workpiece is executed.

For example, if SHAFT1.MPF is selected, SHAFT1.INI is executed when "NC Start" is pressed.

(Behavior as with previous software versions)

\$MN_WPD_INI_MODE=1:

All files of type INI, SEA, GUD, RPA, UFR, PRO, TOA, TMA and CEC which have the same name as the selected main program are executed in the specified sequence.

- The main programs stored in a workpiece directory can be selected and processed by several channels.



References

Commissioning Manual HMI-Advanced (IM4)

6.9.5 Loading/unloading a program



Load
HD->NC



Change
enable

Upload
NC->HD



Function

Programs can be stored in the NC memory ("Load") and then erased from it again ("Unload") after execution. This prevents the NC memory from being overloaded unnecessarily.

Sequence of operations

Position the cursor on the program to be loaded.

The highlighted program is loaded from the hard disk to the NC memory.

The selected program is deleted on the hard disk.

See also Chapter "Job list".

If enable is set "(X)", the program can be executed.

The highlighted program is unloaded from the NC memory to the hard disk.

The selected program is deleted in the NC memory.

Additional information

Programs which have been loaded to the NC memory are automatically marked with an "(X)" (in the "Loaded" column) in the program overview.

If the file is located both on the HMI and the NC, the identifier "X" is only removed when the files are no longer identical.

If the files have different time stamps or are of different lengths, the identifier is "!X!".

If you want to "load/unload" a workpiece directory and a job list with the name of the directory exists in the directory, then this job list is processed.

If no job list exists, all the files in that directory are loaded/unloaded (working memory of NC might overflow!).

6.9.6 Manage programs



Function

You can reorganize programs and files in the "program overview" using the "Manage programs" function:

New...	Select new workpiece/part program
Copy/insert	Copy directories and files
Delete	Delete workpieces and files
Rename	Rename file and data type
Modify enable	Enable each workpiece/part program in the program overview or not.

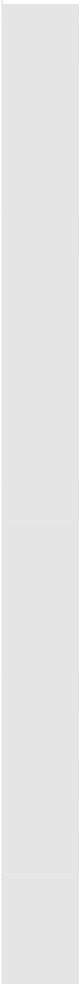

Manage programs...

New...

Default setting



Abort

OK

Sequence of operations

In the "Program overview" dialog box, press the "Manage programs..." horizontal softkey. Active functions are indicated by softkeys in which the text appears on a black background. Inactive softkeys are grayed out.

Press the "New ..." softkey to select a new workpiece or part program. The "interactive programming" window is opened and the cursor is positioned in the input field for the name of the new directory. Enter the new name of the program. The file type is assigned automatically. The display also shows whether or not a template exists.

You can choose between interactive programming and the text editor. The more frequent choice, file editing with "interactive programming", is the default setting. Alternatively, you can use the text editor to edit files.

Confirm your input with the "Input" key.

This key cancels the entire operation.

Press the "OK" softkey to load the workpiece or part program you have just selected. You can then use the program management functions available in the horizontal softkey bar.

6.9.7 Copying/inserting



Function

This section tells you how to copy files from a source directory to an existing destination directory.

Except when overwriting workpieces, the files are copied from the NC program memory or from the hard disk to:

Hard disk	(HD)	or
NC memory	(NCK)	or
Buffer		or
Diskette	(is specified as network drive)	or
Network drive	(Network1 to Network4)	

All directories with the exception of compile cycles can be copied to the destinations specified above.



Copy/insert

Several selected files or workpieces can be copied together in a single operation.

When copying workpieces:

- All associated files are copied too.
- All files with the workpiece name are automatically renamed to the new workpiece name.
- Files from the Workpieces directory can only be overwritten in another directory.
- All workpiece files of type .WPD can be copied from one drive to any other drive.

Specify the file name and file type

Copying from network drives:

- All data types known to the HMI are set according to their extension and the data management scheme.
- A dialog box is opened for files with an unknown extension.
- You can enter or change the name and file type - up to 3 characters are permissible.

If a file of the same name is already stored on the hard disk or in the NC memory, a dialog box prompts you to change the name and file type. If the source file and destination are identical, the existing file is not overwritten. The copy operation can either be canceled or an integer is added to the existing file name in ascending order.



Manage
program



Copy



Paste

OK



Sequence of operations

The "Manage programs" softkey must be pressed.

Position the cursor on the file that you want to copy and press the "Copy" softkey.

The file is marked as the source for copying. An existing file is either overwritten or, if the name or file type was changed, saved with the new name.

Please note that several "Save as" dialogs give you the chance to change the file name and file type before the files are overwritten. The "Save as" dialog box appears if the "All without query" vertical softkey was not pressed and:

1. you have pressed "Insert" for the first time.
2. the file cannot be created in the current directory.
3. the file already exists.

Press the "Insert" softkey, enter a new name and confirm with "OK".

When you insert a file in a workpiece directory, you can change its file type with the "Toggle" key. The file types are automatically adjusted in the global part program and the global subprogram directory.

Additional information

- Only files can be stored in a workpiece directory but not other workpiece directories.
- If the target specified is incorrect an error message is output.
- If a workpiece directory is copied, all the files that it contains are copied at the same time.
- If the files of a workpiece directory are copied to a new directory, all the files with the same directory name are renamed to the new workpiece directory name.
- If a job list with the name of the directory exists, all the instructions in that job list are renamed.

This function only applies to the "Program" operating area.

When you copy under "Services", the names remain unchanged.

See also section "Renaming".

Query dialogs
"Save as"All without
prompt

Skip file

Abort

OK

In the "Commissioning" operating area, press the "HMI" → "System settings" → "Query" softkeys to specify that a query dialog box is to appear before files are overwritten. Otherwise, the files are overwritten without prompting or a copy is created.

Vertical softkeys for "Save as"

Press the "All without prompt" softkey if all existing files in the current directory are to be created with new names without a "Save as" dialog. All files for which the original file type cannot be created are automatically converted to the specified data type.

Press the "Skip file" softkey if the copy operation is to be continued with the next file.

This key cancels the entire copy operation.

An existing file is either overwritten or, if the name or file type was changed, saved with the new name. The "OK" softkey is disabled if you have to enter a new name. The "Data type" input field accepts 0 to 3 letters.

**Query dialogs**

Copy file from hard disk:

- The file exists on hard disk and is overwritten when you select "OK" if the name/data type is to remain unchanged!
- The file exists on hard disk. When you select "OK" a copy is created if the name/file type is to remain unchanged!

Copy file from NC memory:

- The file exists on the NCK and is overwritten when you select "OK" if the name/data type is to remain unchanged!
- The file exists on the NCK. When you select "OK" a copy is created if the name/file type is to remain unchanged!

Copy a workpiece:

- The workpiece already exists. When you select "OK" a copy of the workpiece is created if a new name is not specified!

Copy a directory:

- The directory already exists. When you select "OK" the contents are overwritten if a new name is not specified!
- The directory already exists. When you select "OK" the contents are overwritten if the directory with a fixed data type cannot be changed.

Copy a file of data type main program (MPF):

- The file cannot be created at this location under its original "main program" data type!

6.9.8 Deleting



Manage
program



Delete

OK



Function

This section explains how you can delete workpieces or files.

Sequence of operations

The "Manage programs" softkey must be pressed.

Position the cursor on the workpiece or the file you want to delete.

Delete several files:

If you wish to select several files, position the cursor on the first file, press the "Select" key and then position the cursor on the last file. The files you have selected are highlighted.

The prompt "Do you really want to delete the file?" appears.

Confirm your input.

Additional information

- You can only delete programs that are not currently running.
- If you want to delete a workpiece directory, make sure that none of the programs it contains is currently selected.
- If a workpiece directory is deleted, all the files that it contains are deleted at the same time.

6.9.9 Renaming



Manage
program



Rename



Function

As regards files, you can alter their name as well as the associated file type.

Sequence of operations

The "Manage programs" softkey must be pressed.

Position the cursor on the file you want to rename.

The "Rename" dialog window opens.

Enter the new name.

When you rename a workpiece, you can also change the file type with the "Toggle key". File types are matched automatically in the part program and subprogram directories.

There are two ways of renaming files:

- Renaming the workpiece directory
- Renaming a directory in the workpiece directory

Rename a workpiece directory:

When you rename a workpiece directory, all the workpiece files under that directory that have the same name as the directory are renamed. If a job list with the name of the directory exists, the instructions in that job list are also renamed.

Comment lines remain unchanged.

Examples:

Workpiece directory `A.WPD` is renamed `B.WPD`:

All files with the name `A.XXX` are renamed as `B.XXX`, i.e. the extension is retained.

If a job list called `A.JOB` exists, it is renamed as `B.JOB`.

If this job list contains instructions of file `A.XXX` and these are located in this workpiece directory, then that file is also renamed `B.XXX`.

If job list A . JOB contains an instruction

```
LOAD/Work.DIR/A.WPD/A.MPF
```

it is renamed as

```
LOAD/Work.DIR/B.WPD/B.MPF
```

However, if a job list contains the instruction

```
LOAD/MPF.DIR/A.MPF or
```

```
LOAD/Work.DIR/X.WPD/A.MPF
```

the files are not renamed.

Rename a directory in the workpiece directory:

If you rename the files in the workpiece directory, all files with the same name but a different extension are renamed.

Exception: If a job list of the same name exists in the directory, then this one is not renamed.

6.9.10 Enabling



Function

The program overview indicates whether a workpiece or part program is enabled.

This means that: it may be executed (e.g., because it has already been tested) by the control after you select the "Program selection" softkey and the "NC Start" key.

If you set up a new program, it is automatically enabled.



Sequence of operations

To set the enable for a program or abort it, position the cursor on the desired workpiece or part program in the program overview.

Press the "Change enable" softkey.

A cross indicating "Enable issued" appears behind the workpiece or part program.

Enable issued (program can be executed)

No enable issued (program must not be executed)

Change
enable



Additional information

- The system checks whether a program may be executed when the program is called (after selection via operator input or from part program). If you want it to be enabled, you must enable it beforehand.
(See also Chapter 6 "Changing properties of file/directory/archive")

6.9.11 Protocol



Function

If you are working on the hard disk, the following data are included in the log:

- Name of program currently being executed (execution from external source)
- Names of previously executed programs
- Prompts: e.g. "Do you really want to delete job?"
- Error list: Names of previously executed programs in which an error occurred.



Sequence of operations

Press the "Log" softkey.
The "Job log for programs" window opens.

Depending on the status of the current program run, the following functions can be executed by means of the vertical softkeys (e.g. when prompt "Really delete?" is displayed in the "Query" window):

- The program currently being executed is deleted.
- All programs in the current job list are deleted.
- The program currently being executed is not deleted.
- The program currently being executed is aborted.

Log

Yes

All

No

Stop

6.10 Accessing an external network drive/computer



Function

With the SINDNC software, you can link your control to external network drives or other computers. The following conditions apply:

- The SINDNC software is installed.
- The computer or drive which you want to link up to is accessible/enabled.
- A connection to the computer/drive has been established.
- The softkeys to select the drive/computer connection have been configured by making entries in the file "MMC.INI".

See: Commissioning Manual HMI-Advanced (IM4)



Sequence of operations

You can access network drives 1 to 3 from level 0 of the Program operating area using horizontal softkeys 4 to 6. With the "ETC" key, you can access network drive 4 from level 2 using horizontal softkey 7. The cycle directories are also stored at level 2 and are assigned to softkeys 4 to 6.

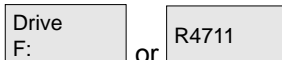

When you press a softkey, e.g., "Drive F:" or "R4711" the Explorer appears on the screen with the data of the external drive, e.g. "Drive F" or of computer "R4711".

You can perform the following operations (in addition to paging) via the vertical softkeys in the Program operating area:

- Copy/insert files (not directories) from network drives in the data manager. A type conversion cannot be performed according to the destination directory.
- Copy/insert from the data manager or a network drive to network drives. The files are set up on the network drive using DOS naming conventions. The file name used in the data management (source) is maintained.
- Deleting files (no directories) on the network drives
- Simulation
- Editing files (find/go to, mark block, edit) if write access to the drive is enabled.
- Files on the network drives can be simulated.
This applies to files with the identifier MPF or SPF.

Additional information

- If the drive/computer is not connected or enabled, the message "No data available" is displayed.
- A root directory can only be selected as the destination for copying to a network drive if "." is displayed.
- In the Machine operating area, only files with an HMI-compatible name can be selected for "Exec. f. hard disk" (i.e. up to 27 characters, no special characters, no blanks).
- In operating area Program, the functions Copy, Insert, and Delete can only be applied to files **without** blanks in their name.
- The file name is displayed as it would be in the Windows Explorer with a long file name, but only up to 25 characters are displayed.

Services operating area

7.1	Services main screen.....	7-359
7.1.1	Reading-in data.....	7-362
7.1.2	Reading-out data	7-363
7.1.3	Displaying the log.....	7-364
7.2	Managing data	7-366
7.2.1	New file/new directory.....	7-367
7.2.2	Loading and unloading.....	7-367
7.2.3	Copying and inserting	7-368
7.2.4	Deleting	7-369
7.2.5	Changing properties.....	7-370
7.3	Data selection	7-373
7.3.1	Special directories and memory areas	7-376
7.3.2	Data on the hard disk.....	7-377
7.4	Transfer display MD from HMI Embedded	7-380
7.5	V.24 interface.....	7-382
7.5.1	Parameterizing the V.24 interface.....	7-382
7.5.2	Using the V.24 interface.....	7-386

7.1 Services main screen

7.1 Services main screen



The diagram shows the status of the SINUMERIK solutionline:

The "Services" Operating Area provides the following functions:

- Read data in/out
- Manage data
- Series commissioning

All programs/data stored on the hard disk or in the NC memory are listed in the "Services" main screen.

Display of the current file tree:

Services	CHAN1	Auto	MPF0
Channel reset		Program aborted	
		ROV	SBL1
Network drives...			
Archive...			
Free memory: Hard disk : 4,2 GB NCU : 9,3 MB			
Disk, archive -> control			
Data in	Data out	Manage data	Data selection

Programs/data: TARGET		\SYF.DIR				
	Name	Type	Loaded	Length	Date	Enable
📁	Archive	DIR			11/07/2005	×
📁	Diagnosis	DIR			11/07/2005	×
📁	Part-programs	DIR	×		11/07/2005	
📁	Subprograms	DIR	×		11/07/2005	
📁	System	DIR	×		11/07/2005	
📁	User-cycles	DIR			11/07/2005	×
📁	Workpieces	DIR			11/07/2005	×

The following file attributes can be displayed for each file (depending on the default setting):

Name	Directory name/file name Files with a maximum name length of 25 characters can be managed.
Type	Specifies the file type which matches the file identifier.
Loaded	To execute a program in the NC (through NC Start), it must be loaded into the NC main memory. To ensure that the memory does not become overloaded, however, related programs and data can be loaded explicitly (from the hard disk to the NC memory) and unloaded again (from NC memory back to hard disk).

The current status of a file is indicated by an "X" in a column under "Loaded": File loaded, file can be selected and executed with an NC Start.



Notice: Data may only be loaded for programs for which an enable has been set!

Length

File length in bytes (directory length is not displayed)

Date

Date of creation or date of last modification to file

Enable

Enable (=selection/right to execute) activated "X" or not activated " "
When you set up a program, you may not necessarily be able to process it immediately with an NC Start (e.g. if it is not ready or requires a trial run).
To indicate that a program is ready for NC Start, it is possible to enable or disable the program. The current state of a file is indicated by an "X" in the "Enable" column (= enable activated).

Access authorization

There are also 5 access rights for each file:

- Delete Corresponds to level 1
- Display Corresponds to level 2
- Write Corresponds to level 3
- Read Corresponds to level 5
- Execute Corresponds to level 7

The access right for each file is indicated in the file tree. Not every user should be able to edit data and programs on the control. Access levels are therefore defined for each file. They range from level 0 (SIEMENS password) to level 7 (key-operated switch 0).

For how to set the access rights, see Chapter "Changing properties".



The access rights are not displayed as the numbers 1 – 7 in the display, instead the display only includes objects which can be executed depending on the rights assigned when the control was started.

Data in

Horizontal softkeys

Read in archives/files:

- Archive from (directory "Archive" on the hard disk)
- USB local
- Diskette (if available)

Data from

Read out archives/files

- Archive to (directory "Archive" on the hard disk)
- USB local
- Diskette (if available)

Manage data

Files/directories can be created, loaded, saved, deleted or copied and their attributes can be displayed/changed.

Log

This softkey can only be selected if a log is available, i.e., after a transmission request has been initiated, a log is generated and the softkey becomes active.

Current actions, errors and any prompts are displayed in the job list. Prompts must be acknowledged.

The "Job log" lists, for example, errors that have occurred in data transmission.

Data selection

By using the "Data selection" softkey, you can choose the directories that you wish to have displayed in the "Services" main screen.

>

Series comm.

Expanded softkey bar:

You can archive data for a series commissioning. The softkey is password-protected.

To update the SINUMERIK solution line, select "NC" as the archive content during the series commissioning.

Upgrade

The update function is only available on the SINUMERIK powerline. This function supports updating of the NC system software. For this purpose, you can create an update archive.

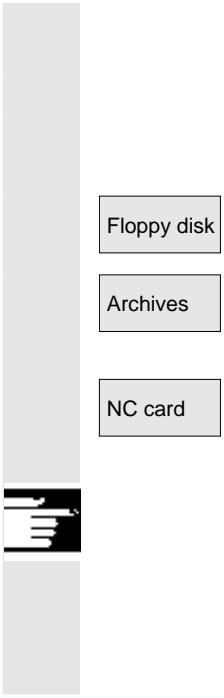

Floppy disk

Archives

NC card

Vertical softkeys

The vertical softkeys allow you to select the source area (for data import) or the target area (for data export). The yellow title in the window indicates the area.

- Floppy disk
- "Archives" directory on hard disk
- "Archives" directory on the NC card

Note:

Users with access authorization to level 3 and higher can access this softkey. It is displayed only if archive `_N_ORIGINAL_ARC` is stored on the NC card.

7.1.1 Reading-in data



Function

When reading in archives and files, the following are possible source areas:

- Archive (i.e. the "Archives" directory) in the directory tree (even if it is not displayed under "Data selection").
- USB memory module
- A diskette drive
- The NC card, if formatted on a Flash File System.

When archives are read in, their format is recognized automatically.

Data with longer file names (> 8 + 3 characters) can be read in from diskette.





Data in

Floppy disk

Archives

NC card

Sequence of operations

The "Programs/Data" file tree is displayed.
The vertical softkey bar changes.

Mark the file into which you wish to read the archive.

Select the source area (see title in window):

- Diskette drive: Shows the contents of the diskette. Select the archive you wish to import.
- Opens the "Archives" directory on the hard disk. Select the archive you wish to import.
- The contents of the archives directory on the NC card are displayed. Select the archive you wish to import.

7.1.2 Reading-out data



Function

Create archives:

With the "Data out" function, the source area (see title in window) for data transmission is the displayed directory tree.

Possible target areas are:

- The "Archives" directory on the hard disk
- USB memory module
- A diskette drive
- Free memory areas on the NC card.



Data from

Floppy disk

Sequence of operations

The "Programs/Data" file tree is displayed.
The vertical softkey bar changes.

You have marked the data that you wish to save/archive.

Select the target area (see title in window):

- Diskette drive: The diskette contents are displayed.
Enter the name of the new archive file.

 Archive

NC card

Start

- The contents of the "Archives" directory on the hard disk are displayed. Enter the name of the new archive file.
- The contents of the archives directory on the NC card are displayed. Enter the name of the new archive file.

When exporting data from diskette/archive, press the "Start" softkey, otherwise the control is ready to receive immediately.

The data transfer is initiated. The vertical softkey bar changes. The softkey labeling of the target area changes to "Stop". To abort data transmission, press the relevant softkey again.

Additional information

Archives to be stored on diskette need **not** fit completely on a single diskette. Distribution of the archive over several diskettes is supported.

When archiving workpieces that contain job lists of the same name, in the case of m:n, you are asked whether the job lists to be unloaded are to be executed. You can terminate the action with "Abort", otherwise all job lists are executed and archiving is then started.

7.1.3 Displaying the log



Function

A job log is generated automatically for each transmission. You can press the "Log" softkey to display the following information:

- The transmitted files in the job list
- The error list, which displays messages regarding whether the transmission has been successful or not.



Services

Sequence of operations

The "Services" operating area is selected.

Log

The "Log" window is opened. The source or target of the job is displayed in the header.

The vertical softkey bar changes.

Manage data

Jobs are assigned to the vertical softkeys, i.e. jobs for

- "Manage data"

Floppy disk

- Floppy disk drive

You can switch between windows with these softkeys.

The softkey label displays "...Stop" if a job is not running. You can abort a job in progress by pressing the "Stop" softkey again.



A message line is displayed in the "Error list" field to indicate whether or not errors have occurred during data transmission.

In the case of queries, the prompt "Please acknowledge query in log window" appears in the user response line.

Confirm the prompt with one of the vertical softkeys:

- Do not confirm
- Confirm all
- Confirm
- Change name/type
- Abort complete job

No

Yes, all

Yes

Name/type

Stop

The currently displayed log is deleted.

The log window is closed when the last log is deleted.

Delete log

7.2 Managing data



Function

Files/directories can be created, loaded, saved, deleted or copied and their attributes can be displayed/changed in the "Manage data" dialog.

Workpieces, part programs, subprograms, standard cycles, user cycles and manufacturer cycles can also be managed as in the program main screen.

This ensures standardized data management.

This affects the following applications:

- Creating new directories and programs
- Loading programs and files to the program memory
- Loading programs and files from the program memory to the hard disk (unloading the program memory)
- Creating new files
- Copying and pasting files
- Deletion operations

Comparison

Vertical softkeys

Main screen in operating area

Programs

Directories/workpieces/
Programs/files

Main screen in operating area

Services

Data/files/comments
Definitions/part programs

Main menu:

- New...
- Load HD->NC
- Unload NC->HD
- Simulation
- Manage programs...
- Selection
- Save setup data

Manage programs:

- New...
- Copy
- Paste
- Delete
- Rename
- Change enable
- <<

Manage data:

- New...
- Load HD->NC
- Unload NC->HD
- Delete
- Properties
- Copy
- Paste

7.2.1 New file/new directory



Manage
data

New...

END

OK

Sequence of operations

Press the "Manage data" softkey.
The horizontal and vertical softkey bars change.

The "New" window appears.

Enter a new file name.

If the pre-assigned file type does not match, use the "End" key to switch between input field "Name" and "File type".
Select the new file type.

The new directory/file is set up in the directory overview.

7.2.2 Loading and unloading



Manage
data

Load
HD->NC

Unload
NC->HD

Sequence of operations

Press the "Manage data" softkey.
The horizontal and vertical softkey bars change.

Position the cursor on the desired file.
The selected file is deleted from the hard disk and loaded to the NC memory. In the display the entry "X" = loaded is added to the file.

See also Chapter "Job list".

The selected file is deleted from the NC memory and loaded to the hard disk. In the display, the entry " " = not loaded is added to the file.

If you want to "load/unload" a workpiece directory and a job list with the name of the directory exists in the job list, that job list is executed.

If a job list does not exist, all the files in that directory are loaded/unloaded.

**Loadable compile cycles**

You can use the HMI user interface to transfer the loadable compile cycles (CC) easily to the NC using an NC card. Further storage locations are any external drive, such as a disk drive, USB memory module or network drives 1 to 4. This storage location appears in the Service operating area under "Manage data".

You can also use the SinuCom NC or SINUCOPY-FFS commissioning tool to transfer the loadable compile cycles into the control.

Load a compile cycle

Each time the NC is booted, all loadable compile cycles with the extension **.ELF**, which are available in the `/_N_CCOEM.DIR` directory, are automatically loaded into the NCK system software. Loadable compile cycles are always loaded on an NCU reset.

For a detailed description of how to install compile cycles, please see: `/FB3/`, TE0 Installation and Activation of Loadable Compile Cycles.

**7.2.3 Copying and inserting****Copy compile cycles****Function**

Following a reset, the optionally available compile cycles are stored on the NCU in the Flash File System (FFS) in directory `/_N_CCOEM.DIR` and can be copied selectively from/to an external drive, disk or NC card.

It is thus possible to archive individual compile cycles.

The "Insert" function is available in addition to "Copy".

You can copy

1. A single file,
2. Several files or
3. A complete directory.

You can display any existing compile cycles in the Diagnostics operating area under Service displays/Version/Compile cycles.

**Sequence of operations**



Press the "Manage data" softkey.

The horizontal and vertical softkey bars change.

Manage
data



Select the source files that you wish to copy.

	Copy	<p>A second window for the target directory (see title in window) is opened. If available, select the target device via the vertical softkeys.</p>
	Programs/ data	<p>The contents of "Programs/data" are displayed.</p>
	NC card	<p>Archive files or complete directories can be copied from an existing NC card.</p>
	USB local	<p>You can use the "Local USB" softkey to access the USB interface on the front panel. This is activated as soon as a USB memory has been plugged in and recognized.</p>
	Floppy disk	<p>If a diskette drive is installed, you can copy to or from diskette. The diskette contents are displayed. Select a target directory.</p>
	Paste	<p>The source files are copied to the target directory you have selected.</p>
>	<p>On SINUMERIK solution line, the NC card softkey has the same functionality after pressing the expansion key.</p>	
NC card		
		<p>With this copying action in operating area "Services" the names remain unchanged. See Chapter "Copy/Insert" in the "Program" operating area.</p>

7.2.4 Deleting



File Directory

Function

You can delete a single file or a group of files (multiple selection).
You can delete a directory and all its contents.

The system settings relating to deletion determine whether a prompt appears before files/directories/data are finally deleted.
See Chapter "Commissioning operating area"



Manage
data

Delete

OK



Sequence of operations

Press the "Manage data" softkey.
The horizontal and vertical softkey bars change.

Position the cursor on the desired file.

A query window appears.

You can delete the highlighted file by pressing "OK".

Archives stored on the NC card can be deleted by selecting "NC card" under "Manage data".

7.2.5 Changing properties



Function

This function allows you to view the contents of a file (or directory) as well as other information, to view file/directory properties and to change some properties.

You can perform the following actions:

- Rename a file
- Convert a file to another file type
- Change the access rights to the file/directory
- View the contents of readable files. The contents of text files are displayed.

You can change access levels only if you have the appropriate access rights to do so.



Manage
data

Properties

Sequence of operations

Press the "Manage data" softkey.
The horizontal and vertical softkey bars change.

The "Properties" window is opened.
Enter the changes you wish to make, e.g. rename the file or change the file type.



Rename file

Place the cursor on the file name and press the "Edit" key (displayed next to the type list), enter the new file name.

There are two ways of renaming files:

- Renaming the workpiece directory
- Renaming a directory in the workpiece directory

Rename a workpiece directory:

When you rename a workpiece directory, all the workpiece files under that directory that have the same name as the directory are renamed. If a job list with the name of the directory exists, the instructions in that job list are also renamed.

Comment lines remain unchanged.

Example:

Workpiece directory `A.WPD` is renamed `B.WPD`:

All files with the name `A.XXX` are renamed as `B.XXX`, i.e. the extension is retained.

If a job list called `A.JOB` exists, it is renamed as `B.JOB`.

If this job list contains instructions of file `A.XXX` and these are located in this workpiece directory, then that file is also renamed `B.XXX`.

Example:

If job list `A.JOB` contains an instruction

```
LOAD/Work.DIR/A.WPD/A.MPF
```

it is renamed as

```
LOAD/Work.DIR/B.WPD/B.MPF
```

However, if a job list contains the instruction

```
LOAD/MPF.DIR/A.MPF or
```

```
LOAD/Work.DIR/X.WPD/A.MPF
```

the files are not renamed.

Rename a directory in the workpiece directory:

If you rename the files in the workpiece directory, all files with the same name but a different extension are renamed.

Exception: If a job list of the same name exists in the directory, then this one is not renamed.



Change the file type

Use the "Edit" key (displayed next to the type bar) to show the list of file types to which the file may be converted.

Only the file types are displayed which are permissible in the directory where the file is located.

Use the "Direction" keys to display the new file type.

Confirm your selection with the "Input" key (displayed next to the file type you have selected).

The file is assigned the new file type.



OK

Additional information

- No check is made to determine whether or not the file contents may be stored under the new file type!
- The contents of a file are **not** altered when the file type is converted.
- All data types may be stored in the "Clipboard" directory.
- The file type is displayed in the properties window for network drives or disk, and the extension with 0 to 3 characters can be modified in the "Type" input field.

7.3 Data selection



Function

Using the "File selection" softkey, you can choose the directories that you wish to have displayed in the "Services" area.

The directories can be selected for two different access levels:

- Users
- Maintenance

Data selection	Default setting	
	Users	Maintenance
User cycles	X	X
Display machine data		
Logs	X	X
Processing sequence (job sequence)		
Data storage		
Definitions		
Diagnostics		
Interactive programming		
Manufacturer cycles		
MSD data (status data)		
Commissioning		
Comments		
MBDDE alarm texts		
NC active data		X
NC data backup		
OEM data		
Standard cycles		
System		
Part programs	X	X
Templates		
Subprograms	X	X
FDD data (status data)		
Workpieces	X	X
Tool management		X
Clipboard		X

**Keywords/directories
in the hierarchical file
structure**

The different files are made available for transfer under the following directories:

- Data (general)
 - Option data
 - Machine data (all, NC MD, channel MD, axis MD)
 - Setting data
 - Tool offsets
 - Zero offsets
 - Global user data
 - R parameters
- Commissioning data
 - NCK data
 - PLC data
- Compensation data
 - Leadscrew pitch/encoder error
 - Quadrant errors
 - Sag/angularity
- Display machine data
- Workpieces
- Part programs
- Subprograms
- User cycles
- Standard cycles
- Comment data
- Definitions
- Feed drives (FDD)
- Main spindle drives (MSD)
- OEM data
- System data (NC)
- Logbook
- Communication error log

If your control includes additional directories, these can be found in the file tree.



Services

Data selection



Users

Maintenance

Default values



OK

Abort



Sequence of operations

The "Services" operating area is selected.

Press the "Data selection" softkey.

The "Data selection for display" window is opened.

The vertical softkey bar changes.

You can page through the window using the "Page" keys.

You can toggle between the settings

- Users
- Maintenance
- Default values

The "Default values" softkey assigns default values to the settings "User" or "Maintenance". These are suitable defaults that are supplied in the software.

Select, for example, the "User" setting. Position the cursor on an additional directory.

Mark the directory of your choice and press the "OK" softkey.

A reset command by means of the "Abort" softkey for the selected access level resets the data selection.

Additional information

The file tree displays files that the user may view on the basis of his or her access rights.

7.3.1 Special directories and memory areas



The following directories contain special files:

Clipboard

The clipboard is a directory on the hard disk, where files, which cannot be included in the copy target directory, are stored. This may be the case for example, if their file type is unknown, or is not permitted in the copy target directory or if the reading process is canceled (e.g., on USB memory media).

Archive

If you wish to save several files, you can store them in an archive file (.ARC).

The source path for the files, which are to be stored in the archive file, is also saved. This allows the packed file to be transferred back to the same directory from which it was copied when the archive file is unpacked again.

Series commissioning archives are also stored in this directory.

USB memory

The SIMATIC USB FlashDrive has been released for SINUMERIK.



NC active data

The NC memory contains data (e.g. R parameters, tool offsets, machine data) that are not stored there in file format. The directory "NC active data" is provided in the file manager to allow the user to access these data and store them on the hard disk in file format.

If the user wishes to save data in files on the hard disk, they can set up the same directory structure under a directory of any name for "NC data" (.MDN). Via "Copy/paste" any active data can be fetched from the NC and stored in files on the hard disk.

NC-active data cannot be unloaded.

7.3.2 Data on the hard disk



General

Function

In addition to the NC working memory, SINUMERIK controls with HMI are provided with a hard disk. It is thus possible to store all data or programs which are not required in the NC on the hard disk. All data are displayed in a single file tree on the user interface.

In the "Services" operating area, all files on the hard disk and in the NC memory can be:

- Managed (new, load, unload, copy, delete, change properties),
- Saved for a series commissioning (NC, PLC and HMI data) and
- Downloaded to the NC memory (programs and files).

Copy to diskette

When you copy to diskette the full file names are stored on the diskette.



Additional information

The end of block character is displayed not as "LF" but as "¶".



System queries

The system behavior when copying/creating data (e.g. overwrite existing files or query first) can be configured for all operating areas.

Query dialogs "Save as"

In the "Commissioning" operating area, press the HMI/System settings/Query softkeys to specify that a dialog box is to appear before files are overwritten. Otherwise, the files are overwritten without prompting or a copy is created.

Query dialog

Copy file from hard disk:

- The file exists on hard disk and is overwritten when you select "OK" if the name/data type is to remain unchanged!
- The file exists on hard disk. When you select "OK" a copy is created if the name/file type is to remain unchanged!

Copy file from NC memory:

- The file exists on the NCK and is overwritten when you select "OK" if the name/data type is to remain unchanged!
- The file exists on the NCK. When you select "OK" a copy is created if the name/file type is to remain unchanged!

Copy a workpiece:

- The workpiece already exists. When you select "OK" a copy of the workpiece is created if a new name is not specified!

Copy a directory:

- The directory already exists. When you select "OK" the contents are overwritten if a new name is not specified!
- The directory already exists. When you select "OK" the contents are overwritten if the directory with a fixed data type cannot be changed.

Copy a file of data type main program (MPF):

- The file cannot be created at this location under its original "main program" data type!

Vertical softkeys for "Save as"

All without
prompt

Press the "All without prompt" softkey if all existing files in the current directory are to be created with new names without a "Save as" dialog.

All files for which the original file type can be created are automatically converted to the specified data type.

Skip file

Press the "Skip file" softkey if the copy operation is to be continued with the next file.

Abort

This key cancels the entire copy operation.

OK

An existing file is either overwritten or, if the name or file type was changed, saved with the new name. The "OK" softkey is disabled if you have to enter a new name.

Display

The file tree display can be modified by the user:

- Display of file properties
- Number of displayed directories

**Data storage**

Data management directories:

- Workpieces
- Part programs
- Subprograms
- User cycles
- Standard cycles
- Manufacturer cycles

Limit of data management

A total of 100,000 files can be stored in all data management directories, but the number of files in each directory (each *.WPD workpiece directory for workpieces) is limited to 1000 files. Files in other directories do not count toward the total limit of 100,000 files. However, each of these directories is also limited to 1000 files, e.g. a maximum of 1000 archives in the archive directory. Network drives are also limited to a maximum of 1000 files in each directory.

In practice, the number of files available also depends on the file sizes and the available memory space. A large number of files slows down the display generation for directory displays.

7.4 Transfer display MD from HMI Embedded



Function

Usage

When migrating from the HMI component HMI Embedded (PCU20) to HMI Advanced (PCU50/PCU70) you may like to transfer tried and proven display machine data from the HMI Embedded configuration to the HMI Advanced configuration, e.g. for use with ShopMill/ShopTurn. The following section describes how to proceed for to transfer the machine data.

Starting point

Display machine data reside on the NCU for HMI Embedded, and on the hard disk of the PCU50/PCU70 for HMI Advanced.

Case 1:

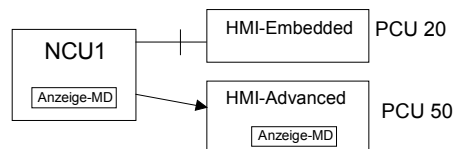

Case 2:

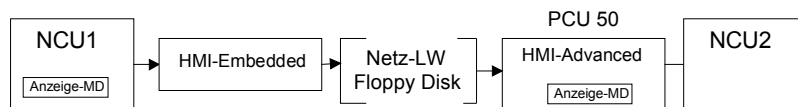

Sequence of operations

The transfer consists of two steps:

- Copy the display machine data with HMI Embedded
- Read into the PCU50/PCU70 under HMI Advanced

Case 1 acc. to diagram

On the HMI Advanced system: **Services** operating area

Transfer display machine data to the display if not yet activated:

Services → Select data

Select "Display machine data"

OK

Copy display machine data:

Services → Manage data

Display machine data\BDxxyy.tea

Copy

Target directory

Select the target directory
Diagnostics\MachDat\OperatorPanel
Paste

Activate inserted display machine data via **Commissioning**:
Commissioning → Machine data →
Display MD → File functions
Set up directory and file BDyy.tea
→Load

Additional information

HMI Embedded manages more display machine data than HMI Advanced. An entry is made in the error log for each proposed display machine data that is not defined in HMI Advanced or contains an error.

Case 2 acc. to diagram

Transfer display MD to floppy disk or network drive:

On the **HMI Embedded** system:

Program → ETC →
Set up operator data BDx.tea
→Copy
→ ETC

Select destination medium: Network drive or floppy disk

Paste

On the **HMI Advanced** system:

Services → Manage data

Select transfer medium: Network drive or floppy disk

Select BDxxyy.tea
→Copy

Continue as for the 1st case, destination directory, see above.

7.5 V.24 interface

7.5.1 Parameterizing the V.24 interface



Parameters for
DIN programs

Function

Default: V.24 user
 Interface: COM1
 Protocol: RTS/CTS
 Parity: None
 Stop bits: 1 With header and trailer labels
 Data bits: 8 Stop with end of data transfer character
 Baud rate: 9600
 Archive format: Punched tape with ... time monitoring (sec.): 04
 With this setting, programs according to DIN are downloaded (starting with %) or output.

Services	CHAN1	Auto	\SPF.DIR W_1.SPF	
	Channel interrupt		Program aborted	
	STOP: No Channel Ready		ROV	

Interface: V24 (RS232C)	
Interface:	COM1
Protocol:	Xon/Xoff <input checked="" type="checkbox"/> XON (hex): 11 XOFF (hex): 0D
Transmission:	Normal
	<input type="checkbox"/> Send XON at Start Data on <input type="checkbox"/> Wait for XON at Start Data off
Parity:	None
Stop bits:	1 <input type="checkbox"/> With leader + trailer
Data bits:	8 bit <input checked="" type="checkbox"/> Stop with EOT character
Baud rate:	9600 End of transmis. (hex): 03
Arch. format:	Punch tape only with LF Timeout (sec.): 4

Data in	Data out	Manage data	Log	Data selection	Interface
---------	----------	-------------	-----	----------------	-----------

Parameters for archiving
with PG/PC

Default: V.24 PG/PC
 Interface: COM2
 Protocol: RTS/CTS
 Parity:
 Stop bits: 1
 Data bits: 8
 Baud rate: ≥ 9600
 Archive format: Binary format (PC format)

Protocol

This setting allows files to be archived and downloaded in the SINUMERIK 840D PC format. When transferring MSD, FDD files, it is not permissible to select "stop with end of data transfer character". Other settings are also possible for ASCII data. These must match those set at the PG.

The 6FX 2002-1AA01- cable is intended for this purpose.

If V.24 data transfer starts, "Services" outputs status messages in the dialog line indicating the data transfer status.

These messages are as follows:

"Wait for CTS signal"

"Wait for DSR signal"

"Wait for Xon character"

"Data transfer active"

The following protocols are supported for transfer using V.24,

- Xon/Xoff and RTS/CTS,
- Software Flow Control and Hardware Flow Control
- Xon/Xoff (handshake)

For V.24 data transfer, the modes wait for Xon to receive and send Xon to send data can be set under "interface".

The default setting is H11 or H13.

One possibility of controlling data transfer is to use the control characters Xon (DC1, DEVICE CONTROL 1) and Xoff (DC3). If the buffer of the peripheral device is full, it sends Xoff, as soon as data can be received again, it sends Xon (= default setting).

Transfer

It is also possible to use a secure protocol for data transfer (ZMODEM protocol).

Normal/secured

For the selected interface, secure data transfer is set in conjunction with handshake RTS/CTS.

"Normal data transfer" is the default setting

The protocol setting is requested for:

- Data input/output
- Series commissioning/upgrade in conjunction with V.24 or PG The SinuCom PCIN software is required as partner on the external PC/PG.

Baud rate

Input: By selecting using the selection key in the “Interface” screen under “Baud rate”

300 baud
600 baud
1200 baud
2400 baud
4800 baud
9600 baud
19200 baud (default setting)
...
115200 baud

Data transfer rates of up to 115 kbaud can be selected. The baud rate that can be used depends on the connected device, the cable length and the general electrical conditions.

Data bits

Number of data bits with asynchronous transmission

Input: By selecting, in the “Interface” screen under “Data bits”

- 8 data bits (default setting)
- 7 data bits

Parity

Parity bits are used for error detection: The parity bits are added to the coded characters to make the number of positions set to "1" an uneven number (uneven parity) or to an even number (even parity).

Input: By selecting, in the “Interface” screen under “Parity”

- No parity (default setting)
- Even parity
- Uneven parity

Stop bits

Number of stop bits for asynchronous data transfer

Input: By selecting, in the “Interface” screen under “Stop bits”

- 1 stop bit (= default setting)
- 2 stop bits

Special Functions

The following special functions are additionally possible; these can be enabled in the interface screen.

If the field has a check mark, this means: Special function active.

Stop with end of data transfer character

Active: Text mode: The end of data transfer character is active.

Inactive: Binary mode: The end of data transfer character is not evaluated.

The default setting for the end of data transfer character is 03 (ETX) hexadecimal.

With header and trailer labels

Active: When entering overread header label - for output, output 120x0(hex) (feed before and after the data).

Inactive: Header and trailer labels are read-in.

When output, no header label of 0(hex).

Download is automatically recognized.

The following archive formats are available:

- Binary format (PC format)
- Punched tape format with LF
- Punched tape format with CR LF

Time monitoring (always)

Active: For data transfer problems or at the end of data transfer (without end of data transfer character) data transfer is interrupted after the specified number of seconds. The time monitoring is controlled by a time generator (clock) that is started with the first character and is reset with each transferred character.

Inactive: Data transfer is not interrupted. The time monitoring can be set (seconds).

Saving V.24 interface settings

V.24 interface settings can be saved in separate files in the V.24 DIR directory. The parameters in a file can, as a whole, be assigned to one of the interfaces. Additional functions are available to manage/update these files.

7.5.2 Using the V.24 interface



V.24 interface

Function

You can output files to an external device or download files from there via the V.24 interface. The V.24 interface and your device must be matched with one another. The control provides you with an appropriate input screen form in which you can define the specific data for your device.

Vertical softkey bar

For each V.24 interface, you can define a parameterization:

- V.24
- PG/PC



Sequence of operations

"Interface" softkey

Press the "Interface" softkey. The vertical softkey bar changes. Select the interface that you wish to parameterize.

"Standard values" softkey

The default values for "V.24 interface" or "PG interface" are accepted, depending on which interface has been selected for parameterization. If a file has been assigned to the interface, then this assignment is cancelled. The file name is removed from the softkey.

"V.24" softkey

V.24 (default setting): If a parameter file is assigned to the current interface, then instead of V.24, the name of this file is displayed.

"PG" softkey

Programming device/PC: If a parameter file is assigned to the current interface, then instead of the PG, the name of this file is displayed.

"Manage" softkey

An additional screen form can be selected with which V.24 parameter files can be set-up, deleted, copied, assigned and displayed. Refer to the **Manage** sub-item

"Abort" softkey

Back to the previous screen form

“OK” softkey

The actual settings are activated and saved in the parameter file. If a parameter file name is displayed in the header line, then the displayed interface parameters are saved in this file. Saving in a file with the “Interface”: None” setting is rejected with an error message. The settings are activated for the actual interface if a file name is not displayed in the header line or if this file is assigned the actual interface.

Refer to the **Manage** sub-item

The V.24 interface dialog box is accessed, if:

- A V.24 parameter file was selected in the “Services” main screen and was acknowledged using the “Input” key.
- The “Interface” softkey was pressed in the “Services” main screen. In this case, the parameters of the V.24 and PG interfaces are available for processing as before. The interface parameters are saved independently of the V.24 DIR directory.

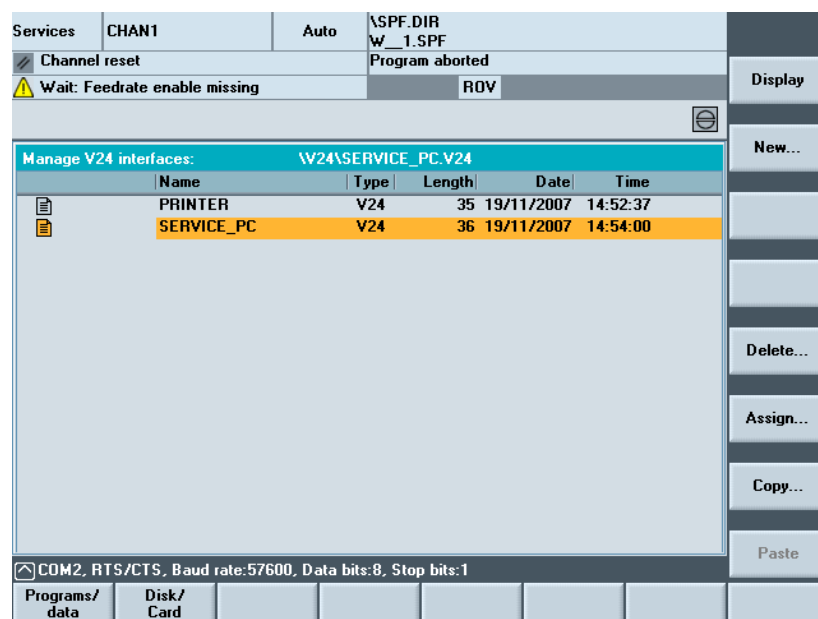
Manage**“Display” softkey**

The parameters of the selected V.24 parameter file are displayed in the “V.24 interface” screen. The file name is displayed in the header line of this dialog box.

“New...” softkey

After entering a file name (max. 10 characters) the actual V.24 parameters are written to a new file in the V24.DIR directory.

“Delete...” softkey

After being acknowledged by the user, the selected V.24 parameter file is deleted. If a file that is assigned to an interface is deleted, then its file name is also removed from the interface softkeys.

“Assign...” softkey

A V.24 parameter file is assigned to the actual interface in a dialog box. The associated parameters are activated and the file name is displayed on the corresponding softkey (instead of V.24 or PG). The status line shows the parameters saved in the file. The actual interface for the assignment can be temporarily modified using the vertical softkeys.

"Copy..." softkey

1. After entering a new name (max. 10 characters), the actual V.24 parameter file is
 - a) copied into the V24.DIR directory or
 - b) by pressing the “floppy disk” softkey is saved on floppy disk, or
 - c) by pressing the “clipboard” softkey is copied into the clipboard
2. If several files are selected at the same time, then only copies on the floppy disk or the clipboard can be activated. When copying to floppy disk or the clipboard, it is not possible to assign a new file name.

Status line

The following data is displayed in the status line associated with the currently selected parameter file:

- COM1 or COM2
- Xon/Xoff or RTS/CTS
- Baud rate
- Number of data bits
- Number of stop bits

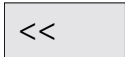

Return jump to the “Interface: V.24” dialog box

Error handling

Only V.24 parameters with the entries Com1 or Com2 can be saved in the field "Interface:".

If an error is detected when displaying/assigning a V.24 parameter file, then its file name is displayed in the screen interface: V.24 in the header line.

Cancel assignment

If a “none” is in the screen “Interface: V.24”, interface field: and if a V.24 parameter file is assigned, then the assignment is cancelled when OK is pressed.



Booting

After booting, the assigned files are displayed on the V.24 PG softkeys and their settings for the interfaces are activated. If the assigned files are not found, then the standard texts are re-displayed (V.24 or PG). The corresponding interface is then assigned with the last V.24 parameters.

Notes

Diagnostics operating area

8.1	Diagnostics main screen.....	8-392
8.2	Remote diagnostics	8-394
8.3	Alarms and messages	8-394
8.4	Service displays	8-396
8.4.1	Service axis.....	8-398
8.4.2	Service drive	8-399
8.4.3	Service SI (Safety Integrated).....	8-400
8.4.4	Systemressourcen anzeigen.....	8-412
8.4.5	Configuration data output.....	8-413
8.4.6	Communication error log.....	8-413
8.4.7	Action log	8-414
8.5	Calling the version screen.....	8-414
8.5.1	Sorting and saving version data.....	8-415
8.5.2	Display the version screens for cycles.....	8-416
8.5.3	Cycle version output	8-419
8.5.4	Displaying loadable compile cycles	8-419
8.6	Interrogating the PLC status	8-421
8.6.1	Changing/deleting a value	8-422
8.6.2	Assign symbolic PLC addresses.....	8-423
8.6.3	Select operand screens for PLC status	8-428
8.6.4	File functions	8-429

8.1 Diagnostics main screen

A display headed "Alarms" appears when you select the "Diagnostics" operating area.

Main screen

No.	Date	Delete	Text
4010	03/12/2007 09:55:49		Invalid identifier used in machine data \$MN_AXCONF_MACHAX
8081	03/12/2007 09:55:49	⊖	5 option(s) is/are activated that are not licensed by the license
15180	03/12/2007 10:51:44	⊖	Channel 1 block : Error on editing program _N_SMAC_DEF as I
14000	03/12/2007 10:51:44	⊗	Channel 1 block 2 illegal end of file
15185	03/12/2007 10:51:44		Channel 1 1 errors in INI file
14710	03/12/2007 10:51:44	⊗	Channel 1 block 0 error in initialization sequence in function 5
400260	03/12/2007 10:51:47	⊖	Failure of machine control panel 1

Number

The alarm number is output under "Number". The alarms are output in chronological order.

Date

The date and time at which the alarm occurred is displayed with the date, in hours, min, sec.

Clearing criterion

The symbol denoting the alarm abort key is displayed for every alarm.

Text

The alarm text is displayed under "Text".

Horizontal softkeys

Alarms

All active alarms are displayed in the "Alarms" display.

Messages

An overview of active messages is displayed.

Alarm
log

The alarm log of alarms and messages that have occurred is displayed. The log also includes alarms that have already been reset. Default setting for the alarm buffer: 150 alarms/messages

Service
displays

You can view updated information about axes and drives installed in your system under the "Service displays" softkey.

PLC- status

Information on the current status of the PLC memory locations.

Vertical softkeys

Acknowl.
HMI alarm

HMI alarms (alarm number 120...) that have occurred can be acknowledged.

Acknowl
SQ alarm

SQ alarms (PLC alarms) that have occurred can be acknowledged.



Safety Integrated

If the "Safety Integrated" option is active, in addition, the two following softkeys are available in the "Alarms" main screen:

SI HW
bestätigen

This softkey is only displayed if new hardware is found. Message 27035 is then output with the request to acknowledge the new hardware components and to perform a function test (this depends on the access level: As a minimum, key-operated switch position 3 is required).

SI Alarmer
ausfiltern

After this softkey has been pressed, the display of SI alarms is filtered-out and suppressed in the "Alarms" window. The SI alarms are still displayed in the header.

8.2 Remote diagnostics



ePS
Network

The control can be operated externally over a remote connection (e.g. modem) The ePS Network Services software is installed with HMI-Advanced. The program is started using the "ePS Network" softkey when selecting the operating areas.



References

For further information about remote diagnostics, please refer to:

- Function Manual: ePS Network Services
- /FBFE/ Description of Functions: Remote diagnostics

8.3 Alarms and messages



Function

You can display a list of alarms and messages and acknowledge them.



Sequence of operations

Alarms

Alarms:

The alarm overview displays all active alarms with alarm numbers, date, clearance criteria and descriptions.

Clear the alarm by pressing the key that is displayed as a symbol:
Switch device off and on again (main switch) or NCK POWER ON



Press "Reset" key.



Press "Alarm Cancel" key.



Alarm is cleared by "NC Start".



Alarm is cleared with the "Recall" key.

Messages

Messages:

PLC operational messages that do not have to be acknowledged (as standard) (configurable).

Alarm log

Alarm log:

A log containing the alarms and messages that have so far occurred is displayed. 150 alarms/messages can be logged as standard.



It also contains the alarms that have already been acknowledged.



This symbol means "Alarm is still active".

Display new

The alarm is updated (static display).

Save log

By pressing this softkey, the current status of the log is stored in the displayed path and can be archived from here as required.

Sorting old>new

Changing the chronological sorting sequence of the alarms in the display.

Acknowledgement symbols The following acknowledge symbols apply to the HMI and PLC alarms:



HMI alarms



PLC alarms



Safety alarms S



Safety alarms SQ

The SQ alarms are cleared with the "Acknowledge SQ alarm" softkey. The S alarms are display alarms; they do not have to be cleared. The way S and SQ alarms are displayed depends on the settings in the files "MMC.INI" and "MBDDE.INI".

You can determine which acknowledgment symbol is to be displayed for the PLC alarms by an entry in the INI file "DG.INI".

These symbols are available for PLC alarms.



or



References

Activation of the symbols is described in: Commissioning Manual HMI-Advanced (IM4)

8.4 Service displays



Function







When commissioning digital drives and diagnosing faults, the various operating states of individual machine axes can be visualized with a type of traffic light indicator in the "Service overview" display, which you can open from the "Service display" menu.

Service Overview

This overview shows specific enable signals and statuses for each of the available axes 1 to 31. Up to 6 different states can occur on each axis:

Columns for machine axes 1 to 31

Differentiating features of the traffic light indicator for each axis:

	Green:	The axis is behaving normally.
	Yellow:	The axis is not ready.
	Gray:	The axis is not affected.
	Red:	An alarm is pending for this axis.
	Line:	No drive assigned to axis.
	Special characters:	Error when reading the data, e.g., if data not available.

Rows with the drive diagnostic functions

Drive enable (terminal 64/63)
 Pulse enable (terminal 64/48)
 Pulse enable (term. 663 / SI: drive relay)
 Setup mode (terminal 112)
 PLC pulse enable
 Speed controller enable NC

DC link status
 Enable pulses
 Drive ready
 Heatsink temperature warning
 Power section in i2t limitation
 Motor temperature warning
 Measuring system 1 active
 Measuring system 2 active



Service displays

Change selection...

Change configurations



Abort

OK

Selected axes

Active axes

All axes

Sequence of operations

Select the menu "Service displays".

The softkey bars change. The softkeys in the horizontal menu bar allow you to select the various service displays. The vertical softkeys are context-sensitive according to the service display. You can use them to select the axis configuration or define or change a specific axis selection.

Define a specific axis selection

Press the "Change selection..." softkey in the "Service overview" window.

You can compose your own axis list in the "Change configurations" menu. The available axes can be entered in the axis list in any order. Example:

4 axes should appear in the order 1 3 5 8.

The existing axis list appears in "Change configurations", e.g. 1 7 5

Use the "Insert" key to enter the new axes with a space between each axis number: 1 3 5 8

Axis numbers outside the valid range from 1 to 31 are deleted. A default list ("1 2 3 4") is displayed if you try to enter an empty list.

Returns you to the main "Service overview" menu: the changes to the current axis list are not saved.

Returns you to the main "Service overview" menu: the changes to the current axis list are saved and applied with the displayed information.

Display selected axes

Press the vertical softkey "Selected axes".

The window changes to the main "Service overview" menu and the previous axis selection is displayed.

Display active axes

Press the "Active axis" vertical softkey in the "Service overview" window. The active axes appear in the main "Service overview" menu.

Display all axes

Press the "All axes" vertical softkey in the "Service overview" window. The maximum set of possible axes appears in the main "Service overview" menu.

8.4.1 Service axis



Service
displays

Service
axis



PAGE
DOWN

PAGE
UP

Axis +

Axes -

Direct
selection...

Function

The information in the "Service Axis" display is used to

- check the setpoint branch (e.g., position setpoint, speed setpoint, spindle speed setpoint prog.)
- check the actual-value branch (e.g. position actual value, measuring system ½, actual speed value), optimize the position control of the axis (e.g. following error, control difference, servo gain factor)
- check the entire control loop of the axis (e.g. through position setpoint/actual-value comparison and speed setpoint/actual-value comparison)
- check hardware faults (e.g. encoder check: If the axis is moved mechanically, the actual position value must change)
- set and check axis monitoring functions.

References: /FB/, Description of Functions D1, Diagnostics Tools

Sequence of operations

Select the menu "Service displays".

The softkey bars change. The vertical softkeys are context-sensitive according to the service display. The softkeys in the horizontal menu bar allow you to select the corresponding service displays.

Press the "Service axis" horizontal softkey The "Service axis/spindle" window displays reference values and units for the machine axis together with axis name and axis number.

You can page up and down with the "Page" keys.

Vertical softkeys for axis selection

The service values of the next (+) and the previous (-) axis are displayed.

The "Direct selection" vertical softkey in the window of the same name allows you to select an axis directly from the list of available axes.

8.4.2 Service drive



Function

The information contained in the "Drive service" display is used to

- Check the status of the enable and control signals (e.g., pulse enable, drive enable, motor selection, setpoint parameter set)
- Check the status of the FDD/MSD operating modes (e.g., setup mode, parking axis)
- displaying temperature warnings
- Check the current setpoint/actual-value display (e.g. position actual-value measuring system ½, speed setpoint, speed actual value)
- check the drive status
- displaying the current ramp-up phase
- Display the group error message (message status class 1)
- Display the status messages of the drive (e.g. threshold torque not reached, actual speed = set speed)



References

/FB/, Description of Functions D1, Diagnostics Tools



Sequence of operations

Select the menu "Service displays".

The softkey bars change. The vertical softkeys are context-sensitive according to the service display. The softkeys in the horizontal menu bar allow you to select the corresponding service displays.



The "Drive service" window displays information about the axis drive together with axis name and number.

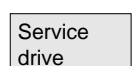

You can page up and down with the "Page" keys.



Vertical softkeys for axis selection

The service values of the next (+) and the previous (-) drive are displayed.



The "Direct selection" vertical softkey in the window of the same name allows you to select an axis directly from the list of available axes.

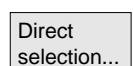

8.4.3 Service SI (Safety Integrated)



Service displays

"Service SI" softkey

Axis +

Axes -

Direct selection...



PAGE DOWN

PAGE UP



References

Sequence of operations

Select the menu "Service displays".
The horizontal softkey bar changes.

The "Service SI" window displays information about Safety Integrated data together with the associated axis name and axis number.

The axis +, axis – vertical softkeys or direct selection are used to set the desired axis. The active axis is displayed in the top right half of the table.

You can page up and down with the "Page" keys.

/FBSI/ Description of Functions Safety Integrated and
/FBSIsI/ Function Manual Safety Integrated

Function

The following information blocks on Safety Integrated data are offered for the selected axis by pressing the "Service SI" softkey:

- Status SI (default setting)
- Cam SGA
- SGE/SGA
- SPL
- SI communication
- SI configuration

Status SI (default setting)

Diagnosis	CHAN1	Jog	\SYF.DIR OSTORE1.SYF
<input checked="" type="checkbox"/> Channel reset			Program aborted
			ROV
Status SI X1 1			
AX1: X1 (DR2:SRM)			
Signal	NCK	Drive	Unit
Safe actual position	0.000	0.000	mm
Position difference NCK/drive	0.000		- mm
Monitoring "Safe operational stop" is active	No	No	
Monitoring "Safe velocity" is active	No	No	
Active SG level	None	None	
Active SG correction factor	None		- %
Safe actual velocity limit	Inactive		- mm/min
Set velocity limitation	Inactive		- mm/min
Current velocity difference	0.000		- mm/min
Max. velocity difference	0.000		- mm/min
Active safe software limit switch	1	1	
Axis safely referenced	Yes	Yes	
Active gear ration [stage]	1	1	
Active stop	None	None	
Currently requested external stop	None	None	

Status SI Cam-SGA SGE/SGA SPL SI communication SI configuration

Available signals/values

- Safe actual position
- Position deviation NCK/drive
- "Safe operating stop" monitoring active
- "Safely-reduced speed" monitoring active
- Active SG step
- Active SG correction factor
- Safe actual speed limit
- Setpoint speed limit
- Actual speed difference
- Maximum speed difference
- Active safe software limit switch
- Axis safely referenced
- Active gear ratio (step)
- Active stop
- Currently requested external stop
- Pulses enabled
- Axis at standstill (SGA "n < nx" =1)
- Request, "close brake"
- Traversing inhibit due to a stop on another axis
- "Test stop" – selection active
- Stop F code value

“Cam SGA” softkey

Using this softkey you can select the display of “cam SGA” signals.

Signal	NCK	Drive	Unit
Active Safe Cams:			
Position > Cam SN1+	No	No	
Position > Cam SN1-	Yes	Yes	
Position > Cam SN2+	No	No	
Position > Cam SN2-	Yes	Yes	
Position > Cam SN3+	No	No	
Position > Cam SN3-	Yes	Yes	
Position > Cam SN4+	No	No	
Position > Cam SN4-	Yes	Yes	
Cam Synchronization/Hysteresis	Active	Active	
Safe actual position	0.000	0.000	mm

Cam synchronization is executed between NCK and PLC at the cam SGA.

“SGE/SGA” softkey

Using this softkey, you can display the signals of the safety-relevant inputs and outputs.

Signal	NCK	Drive	Unit
SGE			
Safe input signals NCK bit 0...15		0000 0000 0000 1011	
Safe input signals drive bit 0...15		0000 0000 0000 1011	
Safe input signals NCK bit 16...31		1111 0000 0011 1100	
Safe input signals drive bit 16...31		1111 0000 0011 1100	
SGA			
Safe output signals NCK bit 0...15		1010 1010 1000 0100	
Safe output signals drive bit 0...15		1010 1010 1000 0000	
Safe output signals NCK bit 16...31		0000 0000 0010 0000	
Safe output signals drive bit 16...31		0000 0000 0010 0000	
Safe cam signals NCK bit 0...31		0000 0000 0000 0000 0000 1010 1010	
Safe cam signals drive bit 0...31		0000 0000 0000 0000 0000 1010 1010	

"SPL" softkey

Use this softkey to display the safe programmable logic signals SPL.

Variable	Bit	Current values	Format
<input type="text" value="\$A_PLCSIIN"/>	<input type="text" value="08...01"/>	0100 0000	B
<input type="text" value="\$A_INSE(P)"/>	<input type="text" value="32...25"/>	NCK 1111 0011 PLC 1111 0011	B
<input type="text" value="\$A_MARKERSI(P)"/>	<input type="text" value="08...01"/>	NCK 0000 1111 PLC 0000 1111	B
<input type="text" value="\$A_OUTSE(P)"/>	<input type="text" value="56...49"/>	NCK 1100 0000 PLC 1100 0000	B
<input type="text" value="\$A_OUTSE(P)"/>	<input type="text" value="64...57"/>	NCK 0000 1100 PLC 0000 1100	B

Signal	Value
DCC fill level	0
DCC status	No errors occurred
DCC control word	DCC tolerance time 1s
SPL booting state	0011 1110 1111 1111

Bottom navigation bar: Status SI | Cam-SGA | SGE/SGA | **SPL** | SI communication | SI configuration

The available signals can be seen in the above screen.

Selectable variables

In the "Variable" selection box, you can choose:

- \$A_INSE(P) corresponds to simultaneously selecting upper line, origin of the NCK and bottom row; PLC origin
- \$A_INSE
- \$A_INSEP

effectively the same for the other variables:

- \$A_OUTSE(P)
- \$A_INSI(P)
- \$A_OUTSI(P)
- \$A_MARKERSI(P)
- \$A_PLCSIIN
- \$A_PLCSIOUT

Saving

The variables that have been selected and the associated bit areas are saved and are taken into account when subsequently selecting the screen.

Bit

Under Bit you can request an 8-bit range from the selected signal. In addition to the current values, the origin of the displayed NCK/PLC signals is displayed.

Format

The following formats can be selected in the variable rows using the "Select" key:

B Binary
H Hexadecimal
D Decimal

The same formats can be selected in the submenu using the "Pre-assigned format..." softkey. The selected format is applied to **all** variable displays in the screen.

Individually set or fixed format settings are saved and taken into consideration in the following displays.

Signal ... value

KDV level (KDV = cross-checking)

Cross-checking status

Cross-checking control word

SPL powered-up state

SPL powered up

SPL interfaces are parameterized

"SAFE.SPL" SPL program file loaded

NCK and PLC state

Interrupt for SPL start should be assigned

Interrupt has been assigned for SPL start

Interrupt processing for SPL start called

Interrupt processing for SPL start terminated

SPL start via Prog_Event

NCK cross-checking has been started

PLC cross-checking has been started

Cyclic SPL checksum test active

All SPL protective mechanisms active



"SI communication" softkey

SI communication (Example: SINUMERIK solution line)

Signals

"General" softkey

"Send connection" softkey

"Receive connection" softkey

Function

Using this softkey, you can select the display of the Safety Integrated communication: The dialog box "SI communication (general)" indicates the communication data for sending (F_SENDDP) and receiving (F_RECVDP) in a tabular form.

Send/Receive	Value	Unit
Parameterized CPU-CPU communications clock cycle	0.010	s
CPU-CPU actual communication clock cycle	0.014	s
CPU-CPU maximum communication clock cycle	0.018	s
Number of active Send-connections	2	-
Number of active Receive-connections	2	-

The screenshot also shows a top status bar with 'Diagnosis CHAN1', 'Jog', and file paths. A 'Channel reset' button is visible. On the right side, there are vertical softkeys: 'General', 'Send connect.', and 'Receive connect.'. At the bottom, there is a row of softkeys: 'Status SI', 'Cam-SGA', 'SGE/SGA', 'SPL', and 'SI communication' (which is highlighted).

The following signals and values are displayed in this dialog box:

- Parameterized CPU-CPU communication clock cycle status
- Actual CPU-CPU communication clock cycle status
- Maximum CPU-CPU communication clock cycle
- Number of active send data connections (F_SENDDP)
- Number of active receive data connections (F_RECVDP)

Vertical softkeys:

Displays the "SI communication (general)" dialog box.

This means that you change to the "SI communication (send)" dialog box.

This means that you change to the "SI communication (receive)" dialog box.



“Send connection” softkey

Function

The “SI communication (send)” dialog box contains a list of the configuration in tabular form and the status of F_SENDDP.

Diagnosis	CHAN1	Jog	\SYF.DIR OSTORE1.SYF	
<input checked="" type="checkbox"/> Channel reset			Program aborted	
			ROV	Connect. +
SI Communication [Send] to NCU710				Connect. -
Send connection		Value	Unit	
CPU-CPU communication ID		711	-	
Logic base address		810	-	
Verbindungsnummer		3	-	
Parametrierte maximal zulässige Kommunikationszeit		0.500	s	
Actual communication time		0.030	s	
Maximum communication time		0.042	s	
Error reaction		[2] Alarm 27351 (self clear)	-	
Error		No	-	
Diagnosis error code		0H	-	
Substitution values active		No	-	
Actual communication data		0000 0000 0000 0000	-	
Driver state		[5] Standard operation	-	
				General
				Send connect.
				Receive connect.
				Show SPL binding
Status SI	Cam-SGA	SGE/SGA	SPL	SI communication
				SI configuration

Signals

The following signals of the selected connection (in this case, e.g. NCU710) are displayed in this dialog box:

- CPU-CPU communication ID
- Logical base address
- Connection number
- Parameterized maximum permissible communication time
- Actual communication time
- Maximum communication time
- Error reaction
 - Error reactions that can be set:
 - [0] "Alarm 27350 + STOP D/E"
 - [1] "Alarm 27350"
 - [2] "Alarm 27351 (self-clearing)"
 - [3] "No response from the system"
- Errors
- Diagnostics error code
- Replacement values active
- Actual communication data

- Driver state
Status code:
[0] "Not initialized"
[1] "Establish communication after booting"
[2] "Establish communication after error"
[3] "Wait for checkback signals SN=1"
[4] "Receiver waits for user acknowledgement"
[5] "Normal operation"

"Connection +" softkey	Vertical softkeys: Changes to the next send connection (F_SENDDP). If less than 2 connections are configured, then this softkey is not displayed.
"Connection –" softkey	Changes to the previous send connection (F_SENDDP). If less than 2 connections are configured, then this softkey is not displayed.
"General" softkey	Displays the "SI communication (general)" dialog box.
"Send connection" softkey	This means that you change to the "SI communication (send)" dialog box.
"Receive connection" softkey	This means that you change to the "SI communication (receive)" dialog box.
"Display SPL connection" softkey	This means that you change to the "Details, SPL connection (send)" dialog box. This softkey can only be selected if send connections have been configured.
"Display connection" softkey	This means that you change to the "SI communication (send)" dialog box.



"Display SPL connection" softkey

Function

Additional details are displayed in the "Details, SPL connection (send)" dialog box – e.g. the connection data that has been set and the actual communication data.

Diagnosis	CHAN1	Jog	\SYF.DIR OSTORE1.SYF			
Channel reset		Program aborted				
		ROV				
SPL Binding Details (Send) to NCU710						
Communication ID = 710, connection number = 3						
SPL Binding Data						
MD-Index	Assign	Filter	No.	Value	Bit	Value
0	61..64	000FH	61	1	0	1
			62	0	1	0
			63	1	2	1
			64	0	3	0
7	61..64	F000H	61	1	12	1
			62	0	13	0
			63	1	14	1
			64	0	15	0
9	61..64	03COH	61	1	6	1
			62	0	7	0
			63	1	8	1
			64	0	9	0

Buttons: Connect. +, Connect. -, General, Send connect., Receive connect., Show connection, SI configuration

Bottom bar: Status SI, Cam-SGA, SGE/SGA, SPL, SI communication



"Receive connection" softkey

Function

Data for F_RECVDP are displayed using the "Receive connection" softkey.

Diagnosis	CHAN1	Jog	\SYF.DIR OSTORE1.SYF			
Channel reset		Program aborted				
		ROV				
SI Communication (Receive) from NCU710						
Receive connection		Value	Unit			
CPU-CPU communication ID		710	-			
Logic base address		765	-			
Verbindungsnummer		1	-			
Parametrierte maximal zulässige Kommunikationszeit		0.500	s			
Actual communication time		0.030	s			
Maximum communication time		0.040	s			
Error reaction		[2] Alarm 27351 (self clear)	-			
Error		No	-			
Diagnosis error code		0H	-			
Substitution values active		No	-			
Substitution values		1100 1100 0011 0011	-			
Actual communication data		0000 0000 0000 0000	-			
Driver state		[5] Standard operation	-			
Anforderung Anwenderquittierung		No	-			
Sender in deactivated safety mode		Yes	-			

Buttons: Connect. +, Connect. -, General, Send connect., Receive connect., Show SPL binding, SI configuration

Bottom bar: Status SI, Cam-SGA, SGE/SGA, SPL, SI communication

Signals

The following signals of the selected connection (in this case, e.g. NCU710) are displayed in this dialog box:

- CPU-CPU communication ID
- Logical base address
- Connection number
- Parameterized maximum permissible communication time
- Actual communication time
- Maximum communication time
- Error reaction

Error reactions that can be set:

[0] "Alarm 27350 + STOP D/E"

[1] "Alarm 27350"

[2] "Alarm 27351 (self-clearing)"

[3] "No response from the system"

- Errors
- Diagnostics error code
- Replacement values active
- Actual communication data
- Driver state

Status code:

[0] "Not initialized"

[1] "Establish communication after booting"

[2] "Establish communication after error"

[3] "Wait for SN=1"

[4] "Wait for user acknowledgement"

[5] "Normal operation"

- Request user acknowledgement
- Sender in the deactivated safety mode



"Display SPL connection" softkey

Function

Additional details are displayed in the "Details, SPL connection (receive)" dialog box – e.g. the connection data that has been set and the actual communication data.

Diagnosis	CHAN1	JOG Ref	\SYF.DIR OSTORE1.SYF			
Channel reset		Program aborted				
		ROV				
Connect. +						
Connect. -						
General						
Send connect.						
Receive connect.						
Show connection						
SI configuration						

SPL Binding Details (Receive) NCU710						
Communication ID = 710, connection number = 1						
SPL Binding Data			F_RECVDP		\$A_INSE	
MD-Index	Assign	Filter	Bit	Value	No.	Value
0	41..44	000FH	0	0	41	0
			1	0	42	0
			2	0	43	0
			3	0	44	0
11	45..48	00FOH	4	0	45	0
			5	1	46	1
			6	1	47	1
			7	0	48	0

Status SI	Cam-SGA	SGE/SGA	SPL	SI comm- unication		
-----------	---------	---------	-----	-----------------------	--	--



"SI configuration" softkey

Function

Using this softkey, you select the display of the "SI configuration", i.e. the safety options and the safety checksums of the selected configuration.

SI configuration (Example: solution line)

Diagnosis	CHAN1	JOG Ref	\SYF.DIR OSTORE1.SYF			
Channel reset		Program aborted				
		ROV				
SI configuration						
Overview of Safety Options:						
Number of Safety Axes:				5		
SI Basic (4 inputs 4 outputs)				No		
SI Comfort (64 inputs 64 outputs)				Yes		
Overview of Safety Checksums:						
NCK SPL				Checksum 0020e607		
Axis	Checksum NCK			Checksum DRIVE		
	SI Motion MD	SI Motion MD	SI Motion MD	SI Motion Parameter r9728[0]	SI Motion Parameter r9728[1]	CU Parameter r9798
	MD36998[0]	MD36998[1]	MD36998[2]	9497C	A07DF496	B3F9CADC
AX1.X1	24E37029	247922CB	9497C	BC742FA3	A07DF496	84E5B79F
AX2.Y1	271EFD6E	431E3AF5	9497C	18443537	D4DA6115	44EC9DBB
AX3.Z1	81CB757B	7F795443	9497C	8CBBB166	FDC982	2C207E10
AX4.A1	4836F819	E567F6E7	9497C	D1394ACF	A07DF496	7E759E78
AX5.B1	E0477E8A	C02154DE	9497C	CA5EB3B2	D4DA6115	4507EA75
						MM Parameter r9898
						84E5B79F
						4382D939
						8AC55014
						1954A81
						A55F073
SI configuration						

Status SI	Cam-SGA	SGE/SGA	SPL	SI comm- unication		SI con- figuration
-----------	---------	---------	-----	-----------------------	--	-----------------------

The “SI configuration” display includes two information areas; these are displayed in a tabular form:

- An overview of the settings of the Safety Integrated option
- Two tables indicate the checksum for the actual Safety Integrated configuration.

The overview of the Safety Integrated Options includes the number of the Safety Integrated axes configured in machine data 19120 \$ON_NUM_SAFE_AXES as well as an overview of the active Safety Integrated options in machine data 19122 \$ON_NUM_SPL_IO.

Especially the safe options are coded as follows:

0 ==	No inputs/outputs
1 ==	SI basic (4 inputs, 4 outputs)
2 ==	SI comfort (64 inputs, 64 outputs)
4 ==	High Feature (still not available)

for solution line

The overview of the Safety Integrated checksum area includes the checksum for the SAFE.SPF file as well as a table with the axial SI checksums for NCK, SI motion parameters, CU parameters and motor module parameters for each axis (and the corresponding drive) for which safety integrated was enabled:

36901 \$MA_SAFE_FUNCTION_ENABLE <> 0

The checksum data are obtained from the following machine data and drive parameters:

MD 36998[0]	Equal to
MD 36998[1]	Equal to
MD 36998[2]	Equal to
SI Motion Parameter [0]	r9728[0]
SI Motion Parameter [1]	r9728[1]
CU Parameter	r9798
MM Parameter	r9898

8.4.4 Systemressourcen anzeigen



Diagnostics

Service
displays

System-
resources

Stop

Start

Function

For the NC areas you can display the system resources (utilization display) currently being used:

Net and gross runtimes of

- position controller,
- interpolator and
- preprocessing.

Sequence of operations

The "Diagnostics" operating area is selected.

Press the "Service displays" softkey then "System resources".
The "NC utilization" screen is displayed.

The following minimum/maximum total data for the servo, IPO cycle and preprocessing are displayed:

- Net runtime in ms
- Gross runtime in ms
- Level of the IPO buffer in percent
- Total capacity utilization in percent

The display update can be halted with the "Stop" softkey, the displayed values are updated again with the "Start" softkey.

8.4.5 Configuration data output

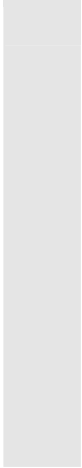

Service
displays

Config.
data



Function

The configuration data of a machine (HMI version, NCU version, axis configuration, drive configuration, bus parameters, active bus nodes) can be written into a file and subsequently read out or printed.

Configuration data is output in 2 stages:

1. Creation of the configuration data file CONFIGURATION_DATA in the "Diagnostics" operating area by pressing the "Config. data" softkey.
2. Read-out of the CONFIGURATION_DATA file in the "Services" operating area. The configuration file CONFIGURATION_DATA is created in the "Services" operating area for this purpose.

Sequence of operations

Select the menu "Service displays".
The horizontal softkey bar changes.

Press the "Config. data" softkey.

The system gathers the configuration data, writes it into the file CFGDAT.TXT and displays it.

The path and name of the file are output in the info line.

Additional information

The configuration data can be read out in the "Services operating area."

8.4.6 Communication error log



Communic.
log



Function

Errors that occur during communication between the HMI and NCK/PLC are registered in a communication error log.
You can display the errors by pressing this softkey.

The error log file is principally used by the control manufacturer (Siemens) as a diagnostic tool for communication errors.

8.4.7 Action log

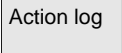

Action log

A existing action log can be displayed with the corresponding authorization (access level: manufacturer).



For configuration of the action log, see
IM4 Commissioning Manual HMI-Advanced

8.5 Calling the version screen



Function

The version data of the installed system software are output in the Version display:

For SINUMERIK powerline Sort and save functions are available for the displayed version data. Version displays saved as ASCII files can be edited as required or sent to the hotline in the event of an error.

For SINUMERIK solution line The version data displayed under “NCU Version” state the software versions on the CF board: This especially applies to measurement cycles and cycle versions. The measurement cycles and cycles that are used by HMI-Advanced are available on the hard disk of the PCU. Their version can be queried via the horizontal softkeys.



Detail

With the “Detail” softkey, you can query further information about a version, for example, to pass it on to hotline support personnel if service is required.

Checking is performed the first time the version display is accessed.

In the case of SINUMERIK solution line, the version number is 8 digits long and structured as follows:

V xx.yy.zz.nn

xx: Major Release

yy: Minor Release

zz: Service pack

nn: Hotfix Number





Service displays

Version

NCU version

HMI version

Cycle version

Definitions

Hardware version

Option: Compile cycles



Sequence of operations

Press the "Service displays" softkey.
The horizontal softkey bar changes.

Open the "Version" window with the following softkeys:

"NCU version" for the version data of the NCU and

"HMI version" for the version data of the HMI.

"Cycle version" Version data for each of the cycle packages

"Definitions" The version data for definitions

"Hardware version" for the version data of the hardware.
(only available for SINUMERIK solution line)

If "Compile cycles" is available on the NCK, the version is displayed.

Use the "Page" keys to scroll up and down.

8.5.1 Sorting and saving version data



Sort

Function

There are various sorting functions for the following version lists:

- NCU version
- HMI version
- Cycle version
- Definitions

In the left-hand part of the pane for sorting, you can select a **sort criterion** from the column designations in the list by pressing the Select key. In the right-hand pane you can choose from **descending** and **ascending** sorting sequence for the selected sort criterion.

Save
versions

The sorted and unsorted version displays of the display area are saved as follows for HMI versions:

Range	Target	File
HMI version	Services→Diagnostics\Log files	HMI.COM

Specific features
of HMI versions

How to save the other areas is described in the area descriptions. Software objects are displayed in **red** if they are not unambiguous (e.g. several executable programs with the same name in different directories) or if the entry in the registry does not match the real storage location of an object.

A language-independent message is displayed in the message line:

1: <actual registry entry> or

1: - , if there is no registry entry or

2 for all other files under a different path

The dialog messages are also written to the log file.

8.5.2 Display the version screens for cycles



Function

The following version screens can be displayed and used to diagnose the cycle states:

- Overview of the cycle packages available on the control.
- Details of the individual packages.
- An overview of all available cycles.
- Separate overview for user, manufacturer and standard cycles.
- Definitions



Sequence of operations

Service
displays

Press the "Service displays" softkey.

The horizontal softkey bar changes.

Versions

Open the "Version" window in the "Service displays" menu.

The following softkeys are displayed:

Package overview

Cycle
version

The cycle packages available on the NCK can be displayed in a separate "Cycle version data" overview by pressing the "Version data cycles" horizontal softkey. The "Package overview" vertical softkey is included automatically.

Package
overview



Predefined package lists

Related cycles can be grouped together in packages and listed in a package list. The complete package is assigned a package name and a version identifier. The file type of the cycle package list is **.cyp** (cycle package).

The package lists are named `cyc_XXX.cyp` and the following standard names are defined:

Package list	Cycle package
<code>cyc_sc.cyp</code>	Standard cycles
<code>cyc_scs.cyp</code>	Cycle support (for standard cycles)
<code>cyc_mc.cyp</code>	Measuring cycles
<code>cyc_mcs.cyp</code>	Measuring cycle support
<code>cyc_mj.cyp</code>	Measuring in JOG
<code>cyc_sm.cyp</code>	ShopMill
<code>cyc_st.cyp</code>	ShopTurn
<code>cyc_mt.cyp</code>	ManualTurn
<code>cyc_c950.cyp</code>	Extended stock removal
<code>cyc_c73.cyp</code>	Pocket surfaces with islands
<code>cyc_iso.cyp</code>	ISO compatibility for cycles
<code>cyc_cma.cyp</code>	Manufacturer cycles (predefined name)
<code>cyc_cus.cyp</code>	User cycles (predefined name)

Details of packages

Cycle
version

Details

Select a package in the package overview and press the "Details" vertical softkey. The following details for the selected package appear in the "Version data" overview:

- Package name Name
- Package type Type
- Load status Loaded
- Package length Length
- Storage directory Directory (in data management)
- Date
- Version entry Version

Overview of

Cycle
version

All cycles

All
cycles

Press the "All cycles" vertical softkey. The "Cycle version" horizontal softkey is included automatically.

All available cycles of the types `.com` and `.spf` from the user cycle (CUS.DIR), manufacturer cycle (CMA.DIR) and standard cycle (CST.DIR) directories are displayed in the "Version data" overview irrespective of the packages.

If a file is stored in several directories, the text color of the active version appears in black in the editor. Inactive files are grayed out.

Cycle
version

User

User
cycles

Manufacturer

Manufact.
cyclesStandard
CyclesStandard
cycles

Definitions

Defini-
tions

Sort

Save
versions

Press the desired vertical softkey

- "User cycles" or
- "Manufacturer cycles" or
- "Standard cycles"

The "Cycle version" horizontal softkey remains active.

All files of the type .com and .spf from the user, manufacturer or standard cycle directory are displayed in the "Version data" overview without the package lists.

The definition files available on the NCK can be displayed in a separate "Version data definitions" overview by pressing the "Definitions" horizontal softkey. All the definition files from the DEF.DIR directory in the data management then appear in this overview.

You can change to another version display by pressing a different horizontal softkey.

The version information can be sorted according to the proposed criteria in either ascending or descending order.

The sorted and unsorted version displays of the displayed definitions are saved as follows:

Range	Target	File
Definitions	Services→Diagnostics\Log files	DEF.COM

8.5.3 Cycle version output

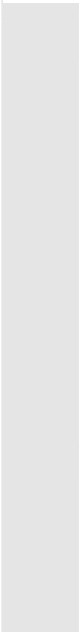

Service displays

Versions

Cycle version

Save versions

Function

You can save the contents of the version displays for cycles in a separate log file.

Sequence of operations

To create a separate log file for the following version contents, press the "Save versions" vertical softkey in the "Version data *type* cycles" version display:

File:	Type:
CYP.COM	Package overview
CYP_DET.COM	Details
ALLCYCLE.COM	All cycles
CUS.COM	User cycles
CMA.COM	Manufacturer cycles
CST.COM	Standard cycles

When the data have been saved, the following message appears:
"File stored!" "

⇒ Services:\Diagnostics\LogFiles\xxx.com.
xxx stands for the file name preceding the extension .COM for each type.

8.5.4 Displaying loadable compile cycles

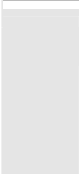
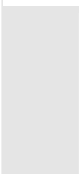

Loadable compile cycles

Service displays

Function

Loadable compile cycles (CC) are an optional extra. The functionality must be enabled explicitly. If loadable compile cycles are available on your NCK, you can display them in a separate "Version data cycles" display under Service displays/Version/Compile cycles.

Sequence of operations

Compile cycles are loaded when you initiate an NCU reset and can then be displayed under Service displays/Version/Compile cycles.

Version

Öffnen Sie im Menü "Serviceanzeigen" das Fenster "Version".
The "Compile cycles" softkey appears.

Compile
cycles

Press the "Compile cycles" softkey.

Display loaded CC

All loaded files of the type `.elf` are displayed in the "Version data compile cycles" overview.



You can check the storage location of the loadable compile cycles in the Services operating area in the "Manage data" main screen. You can copy the available loadable compile cycles from here onto an installed NC card. Other storage locations, such as any external drive, e.g. disk drive or network drives 1 to 4, are supported.

Display non-loaded CC

All non-loaded files of the type `.elf` can also be displayed in the "Manage data" main screen. To do this, select the appropriate directory. You can display all the main properties of an individual compile cycle by selecting any individual file with the extension `.elf`.

Properties

Press the "Properties" softkey

The horizontal and vertical softkey bar changes and a "Properties" window, such as the one below for NC card, appears.

Properties			
Path	:\NCcard\LoadableCompileCycles		
Name	:CCMCSC	Date:	Time
extension	:ELF	Length:	Loaded: <input type="checkbox"/>
Type	:Loadable compile cycle		
Access authorization			
Read:	Write:	Enable:	List: Delete:
Contents: Loadable compile cycle			
Version:	MCSC Coupling axes Machine	Time	Date
Advance version of compile cycle (Preliminary)			
Interface: 001.001@Interfaces=002.000 @TChain=001.000			
Current access authorization access level:			

8.6 Interrogating the PLC status



Inputs:

Outlets:

Bit memories:

Timers:

Counters:

data:

Format:

Function

You can obtain information about the current states of the following memory locations of the PLC and change them if necessary:

Input bit (Ex), input byte (EBx)

Input word (Ewx), input double word (Edx)

Output bit (Ax), output byte (Abx)

Output word (Awx), output double word (Adx)

Memory bit (Mx), memory byte (MBx)

Memory word (MWx), memory double word (MDx)

Time (Tx)

Counter (Cx)

Data block (DBx), data bit (DBxx), data byte (DBBx),

data word (DBWx), data double word (DBDx)

B = binary

H = hexadecimal

D = decimal

G = floating comma (for doublewords)

Operand	Example	Read	Write	Format	Value	Range
Inputs		Yes	Yes			0-127
	I 2.0			B	0	
	IB 2			B	0101 1010	
				H	5A	
				D	90	
Outputs		Yes	Yes			0-127
	Q20.1			B	1	
	QB 20			B	1101 0110	
				H	D6	
				D	214	
Bit memory		Yes	Yes			0-255
	M 60.7			B	1	
	MB60			B	1101 0110	
				H	B8	
				D	180	
Timers	T20	Yes	No			0-31
				B		
				H		
				D		
Counter instructions	C20	Yes	Yes			0-31
				B		
				H		
				D		
DB / Data byte		Yes	Yes			0-255
						0-255
				H	A	
	DB3.DBB9			D	10	
				B	000 0000 0000 1010	



. In HMI, the "Page" keys can be used to scroll up and down.

8.6.1 Changing/deleting a value



Function

The values of operands can be changed.



Sequence of operations

The "Diagnostics" operating area is selected.

Diagnostics

Press the "PLC status" softkey. The first operand screen form appears. The vertical softkey bar changes.

PLC-
Status

Change

Cyclic updating of the values is interrupted.

Operand
+

Operand
-

You can increase or decrease the address of the operand by 1 place at a time.

Softkey allocation

A selection window appears.

Default
format

You can preset the format fields to "B" (binary), "H" (hexadecimal), "D" (decimal) or "G" (floating point).

Change the operand, the format or the value.

Delete

Delete:

The entries for the selected operand (formats and values) are deleted. A query window is opened.

Undo
change

Undo changes:

Cyclic updating is continued; the entered values are not transferred to the PLC.

Accept

Accept:

The entered values are transferred to the PLC. Cyclic updating is continued.



Press the "information key".

A description of the permissible input syntax for the PLC status display is overlaid.

8.6.2 Assign symbolic PLC addresses



Prerequisites



References



Languages

Function

PLC data can also be edited via symbols.

To do this, the symbol tables and texts for the symbols in the PLC project must have been suitably prepared and made available in the HMI.

Additional information

The program **PlcSymbolsGenerator.exe** and its description are located in the PLC tool box. It creates the files with symbols and language-dependent texts in the representation required for the HMI.

Preparation of PLC data:

- Save the files created with PlcSymbolsGenerator.exe in the Services operating area under path: Diagnostics/PLC Data (F:\DH\DG.DIR\PLC.DIR\) with the following predefined names and extensions:
 PlcSym.SNH (symbols)
 PlcSym_<language extension>.SNT (texts e.g. PlcSym_GR.SNT)
- NC RESET or reboot HMI to activate file
- Only for M:N configurations: There must be an entry which makes the symbols available in netnames.ini for each addressable NCU.

For more information, please refer to:

Commissioning Manual HMI-Advanced (IM4)

If the texts (symbol comments) are stored for multiple languages, you can also change language to work with texts in the other languages.



Diagnostics

PLC
symbols

Sequence of operations

The "Diagnostics" operating area is selected. If the above listed requirements are met, the PLC symbol softkey is displayed.

Diagnose	Labor_Kanal1	JOG Ref	\MPF.DIR ABCKOPIE.MPF	
Kanal RESET			Programm abgebrochen	
PLC-Symbole: Übersicht				aktiv
Symbolische Adresse	Absol. Adresse	Format		Wert
TMLoadF.IF[7].Free2	DB71.DBD192	H		##
TMLoadF.IF[7].Free1	DB71.DBD188	H		##
TMLoadF.IF[6].Free3	DB71.DBD166	H		##
TMLoadF.IF[6].Free2	DB71.DBD162	H		##
TMLoadF.IF[1].Free3	DB71.DBD16	H		##
TMLoadF.IF[6].Free1	DB71.DBD158	D		##
TMLoadF.IF[5].Free3	DB71.DBD136	H		##
TMLoadF.IF[5].Free2	DB71.DBD132	H		##
TMLoadF.IF[5].Free1	DB71.DBD128	H		##
TMLoadF.IF[1].Free2	DB71.DBD12	H		##
TMLoadF.IF[4].Free3	DB71.DBD106	H		##
TMLoadF.IF[4].Free2	DB71.DBD102	H		##
TMLoadF.IF[4].TMno	DB71.DBB97	H		##
TMLoadF.IF[4].Channel	DB71.DBB96	H		##

The following are represented in the table from left to right:

- Symbolic address
- Absolute address
- Format
- Value

Select a sort option from:

PLC-Symbole: Sortieren	
<input type="radio"/>	gemäß Symboltabelle
<input type="radio"/>	symbolische Adresse alphanumerisch aufsteigend [A -> Z]
<input checked="" type="radio"/>	symbolische Adresse alphanumerisch absteigend [Z -> A]
<input type="radio"/>	absolute Adresse alphanumerisch aufsteigend [A -> Z]
<input type="radio"/>	absolute Adresse alphanumerisch absteigend [Z -> A]

Depending on your selection, sorting takes place on column one or column two in ascending or descending alphabetical order to make it easy to find a symbol or address. "As in symbol table" means: In the same sequence as the symbol table in the PLC project.

Select the categories of symbols/addresses that you want to display. Press OK to activate the filter. Filters are retained after you exit screens/operating areas and after reboot.

PLC-Symbole: Filter	
<input checked="" type="checkbox"/>	Eingänge
<input type="checkbox"/>	Ausgänge
<input checked="" type="checkbox"/>	Datenbausteine
<input type="checkbox"/>	Merker
<input checked="" type="checkbox"/>	Timer
<input checked="" type="checkbox"/>	Zähler

Vertical softkeys

Sort

Filter

Find/
Go to...

After entering a search term and search direction, the section of the table is displayed with the focus on the symbol/absolute address if it was found.

The search is performed in the following sequence: absolute addresses, symbols.

When you enter the search term in the "Address" field, take care to enter the correct notation. Press OK to start the search.

Symbolische Adresse	Absol. Adresse	Format	Wert
TMLoadF.IF[7].Free2	DB 71.DBD192	H	#
TMLoadF.IF[7].Free1	DB 71.DBD188	H	#
TMLoadF.IF[6].Free3	DB 71.DBD166	H	#
TMLoadF.IF[6].Free2	DB 71.DBD162	H	#
TMLoadF.IF[1].Free3	DB 71.DBD16	H	#
TMLoadF.IF[6].Free1	DB 71.DBD158	H	#
TMLoadF.IF[5].Free3	DB 71.DBD136	H	#
TMLoadF.IF[5].Free2	DB 71.DBD132	H	#
TMLoadF.IF[5].Free1	DB 71.DBD128	H	#
TMLoadF.IF[1].Free2	DB 71.DBD12	H	#
TMLoadF.IF[4].Free3	DB 71.DBD106	H	#

If the search term is not found, the dialog box remains open for a new search. After you change screens, the search term and search direction are retained in the dialog box

Press this softkey to jump to the beginning of the symbol table.

Press this softkey to jump to the end of the symbol table.

All information is displayed for the selected address or symbol in the following representation:

Symbolische Adresse	Absol. Adresse	Format	Wert
B_MA_SKZ_MaschineEin	MB131	H	00
B_MA_SKZ_Oelstand	MB130	H	00
B_MA_SKZ_Schmierung	MB133	H	00
B_MA_SKZ_Schmierzyklus	MB134	H	00
B_MAG_SKZ_Magazin	MB162	H	00
B_MAG_SKZ_Hilfsbehebung	MB162	H	00

PLC-Variablen: Details	
Symbolische Adresse	B_MAG_SKZ_Magazin
Absolute Adresse	MB162
Beschreibung	
Zusatz-Information	MAG: Schrittkettenzaehler Magazin
Format	Hexadezimal
Wert	00

If relevant texts are available in the PLC project, they are displayed here as "description".

Beginning

End

Details

Change

You can change the value of the symbol that is currently displayed in detail.

The input marker is positioned on Value. Value input is completed by pressing the Enter key; however, the values are only activated when the "Accept" softkey is pressed. You can also choose a more suitable display format.

Accept

The entered value is transferred to the PLC interface.

Change

You can change the value for the selected symbol. Value input is completed by pressing the Enter key; however, the values are only activated when the "Accept" softkey is pressed. You can also choose a more suitable display format. Before pressing the Accept softkey to validate the data changes, you can modify any number of symbol values in sequence.

Accept

The previously entered values are transferred to the PLC interface.

Diagnostics

PLC- status

Symbols in the status screen

If the above mentioned requirements are met, the additional "Symbol" softkey is displayed in the PLC status screen.

The screenshot shows the PLC status screen with the following data:

Symbol / Operand	Format	Wert
DB19.DBB26	H	01
DB19.DBX26.0	H	1
DB19.DBW13	B	0000000000000001
B_MA_Entprell_Zaehler	D	0
B_MA_SKZ_HydraulikEin	H	00
	H	
	H	
	H	
	H	

The screen also displays the address 510104 and the value 0000. The status is 'aktiv'. The interface includes softkeys for 'Operand +', 'Operand -', 'Vorbelegung Format...', 'Löschen', 'Symbole', 'Ändern', 'Abbruch', 'Übernahme', and 'Dateifunktionen'.

Symbols

You can use the softkey to switch between absolute addresses and symbols for inputs and display in the status screen.

If a symbol is selected, the "Operand+" and "Operand-" softkeys defined for absolute addresses are not available.

Otherwise, the above description for PLC status also applies to the status screen.

8.6.3 Select operand screens for PLC status

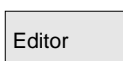
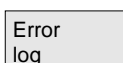
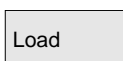
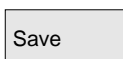
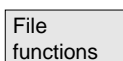
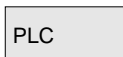
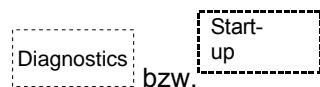

Function

You can save the operands entered in the "PLC status" window to a file or read in a back-up list of operands.

Sequence of operations

The "Commissioning" operating area is selected.

Press the "PLC" softkey.

The horizontal and vertical softkey bars change.

Press the "File functions" softkey.

The vertical softkey bar changes.

Enter the name of the file in which you wish to save the operands.
You can select existing back-up files from a list.

All the following functions refer to the file name entered:

The selected operand back-up file is deleted.

The selected operands are saved to the specified file.

The selected operand file is loaded to the "PLC status" window for processing.

If errors occur during transfer of the machine data, these are entered in an error log.

The error log is transfer-specific, i.e. it is cleared before each new transfer.

The ASCII editor is called with the selected file.
You can now edit the operand back-up file.

8.6.4 File functions



File functions

You can use the file functions to manage operand screens.



Sequence of operations



Diagnostics

PLC status

File
functions

Delete

Save

Load

The "Diagnostics" operating area is selected.

Press the "PLC status" softkey.
The first operand screen form appears.
The vertical softkey bar changes.

Press the "File functions" softkey.
The "File functions" window opens.

Enter the file name of the desired operand screen form or
position the cursor on the desired operand screen form in the list.

The selected operand screen form is deleted.

The current contents of the PLC status are saved in the selected
operand screen form.

The contents of the selected operand screen form are loaded to the
PLC status.

Additional information

The operand screen forms are ASCII files.

Commissioning operating area

9.1	Startup main screen.....	9-430
9.2	Machine data.....	9-432
9.3	NC.....	9-434
9.4	PLC.....	9-435
9.5	Optimization/test (SINUMERIK powerline).....	9-436

9.1 Startup main screen



Danger

Changes in the Commissioning operating area have a significant influence on the machine. Incorrect configuration of the parameters can endanger human life and cause damage to the machine.



Access to certain menus in the "Commissioning" operating area can be protected by keylock switch or password.

This Chapter describes functions which the machine operator can perform on the basis of his or her access rights.



References

Further information regarding startup (commissioning) is provided in Commissioning Manual, HMI-Advanced (IM4).

Target groups include:

- System personnel
- Machine manufacturer
- Service personnel
- Machine users (machine setters)







Function

The "Machine configuration" window is displayed in the "Commissioning" main screen.

The diagram shows the status of the SINUMERIK solutionline:

Start-up	CHAN1	Auto	MPF0	
Channel reset			Program aborted	
			ROV	SBL1
Machine configuration				
Machine axis			Drive	Channel
Index	Name	Type	Number	Type
1	X1	Linear axis		1
2	Y1	Linear axis		1
3	Z1	Linear axis		1
4	A1	Rot. axis		1
5	B1	Spindle		1
6	C1	Rot. axis		1
Current access level: System				
Machine data	NC	Drives	PLC	HMI
				Rap.st-up axis/drive
				Optimiz./test

	Machine data	<p>Horizontal softkeys</p> <p>Enables you to edit the machine data for all areas. (see Section 9.2)</p> <p>You can perform an NC boot in different modes (see Section 9.3).</p>
	NC	
	Drives	<p>Select this softkey to configure the parameters for one or more drives. You can page through the drives using the “Drive +” and “Drive –” vertical softkeys. The “Drive selection...” vertical softkey opens a dialog allowing you to select a drive. By using these three vertical softkeys you can select all of the drive devices on all PROFIBUS segments. The “Change...” softkey starts the configuration assistant for the drive.</p>
	References	<p>/IDsl/ Commissioning Manual CNC Part 1 (NCK, PLC, Drive) /IAD/ Commissioning Manual SIMODRIVE 611 digital</p>
	PLC	<p>The PLC status function is available. You can update the date and time of the PLC and HMI (see Chapter 9.4).</p>
	HMI	<p>Here you can enter the settings on the user interface (see Section 9.5).</p>
	Axis/drive-quick c	<p>This menu contains functions for commissioning the axes and drives.</p>
	References	<p>/FBA/ Description of Functions, Drive Functions</p>
	Optimiz. / test	<p>The system provides support here for commissioning the drive. Coupled axes are supported for measuring in the current control loop, speed control loop or position control loop.</p>
	Licenses	<p>Expanded softkey bar:</p> <p>The license function is only available on the SINUMERIK solution line. Here you can manage and activate licenses for installed software and options (see Section 9.7).</p>
	Tool managem.	<p>This is where you can enter tool data, create tool lists and assign the tool magazine locations.</p>
	References	<p>/FBA/ Description of Functions, Tool Management</p>

9.2 Machine data



Danger

Changes in the machine data have a considerable influence on the machine. Incorrect configuration of the parameters can endanger human life and cause damage to the machine.



Access to the machine data operating area can be controlled by keylock switch or password.



Areas

Function

The machine data is divided into the following areas:

- General machine data (\$MN)
- Channel-specific machine data (\$MC)
- Axis-specific machine data (\$MA)
- Display machine data (\$MM)
- Drive-specific machine data (\$M_)
- Machine data control unit: Drive parameters (solution line)
- Machine data feed-in: Drive parameters (solution line)

A separate list display is provided for each of these areas in which you can view and edit machine data.

The following information about the machine data is displayed from left to right:

- Machine data number
- Machine data name, with field index if applicable.
- Value of the machine data
- Unit of the machine data
- Effectiveness

If the machine data does not use units, no units are displayed.

If the data is not available, the "#" symbol is displayed instead of the value.

If the value ends in an "H", it is a hexadecimal value.



Examples

The physical units of machine data are displayed on the right-hand side of the input field.

m/s**2	m/s ² (meter/second squared): Acceleration
rev/s**3	rev/s ³ (revolution/second to the power of 3): Change in rate of acceleration for rotating axis
kg/m**2	kgm ² (kilogram/meters squared): Moment of inertia:
mH	mH (millihenry): Inductance
Nm	Nm (Newton meters): Torque
us	μs (microseconds): Time
μA	μA (microamperes): Electric current
μVs	μVs (microvolt-seconds): Magnetic flux
userdef	User-defined: The units are defined by the user.

The right-hand column indicates when a machine data becomes effective:

- so = immediately effective
- cf = when confirmed via the "Activate MD" softkey
- re = reset
- po = POWER ON (NCK Power On reset)

Function**File functions**

Enter the name of the file in which you wish to save the operands. You can select an existing back-up file from a list.

File functions: see Subsection 8.5.4



File
functions



9.3 NC



Commiss.
switch

NCK
addresses

NC memory

NCK reset

NCK
gen. reset

Function

The commissioning switch function is only available on the SINUMERIK powerline.

You can only define the commissioning switch settings if you have the appropriate access rights to do so.

The NCK address function is only available on the SINUMERIK powerline.

View the NCU address and change it.

It is normally only necessary to edit the address for M: N operation.

You cannot undo an address change with general reset. It is not saved in a series commissioning archive.

The NC user memories available for programs and data are displayed here:

- Memory overview
- SRAM assignment in bytes
- DRAM assignment in bytes

Further information on the selection can be displayed using the “Details” softkey.

Vertical softkeys

The NCK reset and NCK general reset functions are only available in the SINUMERIK solutionline:

- “NCK Reset” performs a warm restart of the NC.
- “NCK general reset” resets all of the machine data to the default values.

9.4 PLC



Set
date/time



Start-up

PLC

Set
date/time

Accept



References

Function

Changes can only be made with the corresponding access authorization (password):

- Setting date/time (see below)
- PLC status for PLC operands (see Section 8.5)
- File functions (see Subsection 8.5.4)

Danger

Changes in the states of PLC memory locations have a major impact on the machine. Incorrect configuration of the parameters can endanger human life and cause damage to the machine.

Function

You can change the date and time of the PLC and manually synchronize the date and time of the PLC and HMI.

Sequence of operations

The "Commissioning" operating area is selected.

Press the "PLC" softkey.

The horizontal and vertical softkey bars change.

Press the "Set date/clock" softkey. The "Set date/clock" window is displayed.

Enter the correct values in the input fields.

The date and time on the HMI are transferred to the PLC.

The synchronization can be verified in the "Current time:" output field.

The set values are retained when the control is rebooted.

Commissioning Manual HMI-Advanced (IM4)

9.5 Optimization/test (SINUMERIK powerline)



Function

This menu contains functions for commissioning the axes:

- Current control loop
- Speed control loop
- Position control loop
- Function generator
- Circularity test
- Servo trace
- AM/MSD self-optimization (inactive)
- DAC configuration (inactive)

Expanded softkey bar:

- Aut. selector setting

Servo trace involves the recording of up to 10 bit signals throughout the measuring time for bit-encoded Safety Integrated signals.

References

/FBA/ Function Manual Drive Functions
/FBSI/ Function Manual Safety Integrated



Start-up

For commissioning SIMODRIVE 611 digital drives, coupled axes are supported for measuring in the current control loop, speed control loop or position control loop:

- Pure gantry axis groupings
- Pure master/slave relationships
- Hybrid coupling of master/slave axes with gantry axes

Measuring parameters

You can enter specific measuring parameters and select a measurement for each available axis in these axis groupings.

The following measuring parameters are available:

- Amplitude leading axis or master axis
- Amplitude synchronized axis/axes or slave axis/axes
- Bandwidth of the frequency range to be analyzed
- Information on measuring accuracy and measurement duration increase
- Delay settling time
- OFFSET to accelerate via an acceleration ramp

References

/IAD/ Commissioning Manual:
Section "Measuring functions for coupled axes"



for gantry axis grouping,
for master/slave couplings

Display all coupled axes

You can record the results for up to two axes simultaneously. There is always **only one** leading axis. All other axes are synchronized axes; their amplitude can be assigned separately. All active axes of the grouping are displayed.

For non-mixed couplings, the following axes can be seen as a maximum:

- one leading axis and two synchronized axes.
- one master axis and two slave axes

With a hybrid master-slave coupling with pure gantry axes the leading axis always comes from the pure gantry axis grouping. All other axes are synchronized axes. The texts displayed in the operator interface change and are updated according to the active type of coupling.

You can navigate through all active axes in the "Gantry measurement" or "Master / slave measurement" selection screens where all active couplings are displayed. You can measure up to 2 axes simultaneously. The measuring process must be repeated after each axis selection.

The axis couplings show the axis identifiers e.g. X1, Z1 or A1 as well as the axis number of the respective axis grouping.

The values have the following meanings:

SRM Synchronous motors (synchronous rotation motor)

ARM Asynchronous motors (asynchronous rotation motor)

Additional information

The HMI does not support initiation of a measurement job for a master/slave coupling in the position control loop. If you are currently performing a position control measurement on an axis which is coupled but not initiated by the HMI, the start is inhibited for this slave axis and a message is displayed.

When optimizing or measuring gantry axes, HMI Advanced V06.03.xx should be used if at the complete coupling at least two involved axes are configured on one control module. This also includes master/slave axes.

Notes

Maintenance



10.1	Operating data	10-440
10.2	Cleaning	10-441

10.1 Operating data

Operating data

	Value
Air humidity, humidity class to DIN 40040	F
Atmospheric pressure	860 to 1080 hPa
Protection against physical contact protection class to DIN VDE 0160	I
Degree of protection according to DIN 40050	
• Front of operator panel	IP 54
• Back of operator panel	IP 00
• Front of machine control panel	IP 54
• Back of machine control panel	IP 00

References

You will find the comprehensive operating data in the documentation /BH/ Operator Components Manual and in the relevant information sheets.

10.2 Cleaning

Cleaning agents

The front of the monitor and the surface of the operator panel front can be cleaned. For dirt that is relatively easy to remove, standard household washing-up liquid, or an industrial cleaner (such as "Special Swipe") can be used. These cleaners will also remove dirt containing graphite.

Cleansing agents which contain one or more of the following ingredients can be used for a short period of time:

- Diluted mineral acids
- Bases
- Organic hydrocarbons
- Detergent solutions

Plastic material used

The plastic material used on the front of the OP015, OP012 or OP015 is suitable for use on machine tools.

It is resistant to:

1. Greases, oils, mineral oils
2. Bases and lyes
3. Detergent solutions and
4. Alcohol

Solvents such as chlorinate hydrocarbons, benzene, esters and ethers should be avoided!



Notes

Appendix



A	Abbreviations	A-444
B	Terms	A-448

A Abbreviations

O	Output
ASCII	American Standard Code for Information Interchange American Standard Code for Information Interchange
Mode group	Mode group
OPI	Operator Panel Interface
CAD	Computer-Aided Design
CNC	Computerized Numerical Control Computerized Numerical Control
CR	Carriage Return
DAU	Digital-to-Analog Converter
DB	Data Block in the PLC
DBB	Data Block Byte in the PLC
DBW	Data Block Word in the PLC
DBX	Data block bit in the PLC
DIN	Deutsche Industrie Norm (German Industry Standard)
DIR	DIRectory: Directory
DPM	Dual-Port Memory
DOS	Disk Operating System
DRAM	Dynamic Random Access Memory
DRF	Differential Resolver Function: Differential revolver function (handwheel)
DRY	DRY run: Dry run feedrate
DW	Data Word
I	Input

FRAME	Data block (FRAME)
BP	Basic program
GUD	Global User Data : Global user data
HD	Hard Disk Hard disk
AuxF	Auxiliary Function
MSD	Main Spindle Drive
HW	Hardware
IBN	Commissioning
ICA	Interpolatory Compensation Interpolatory compensation
INC	Increment : Increment
INI	Initializing Data : Initializing data
IPO	Interpolator
ISO	International Standard Organization
ISO code	Special punched tape code, Number of holes per character always even
JOG	JOGging: Setup mode
C1 .. C4	Channel 1 to channel 4
LED	Light Emitting Diode: Light emitting diode
LF	Line Feed
K_v	Servo gain factor
LUD	Local User Data
MB	Megabyte
MBDDE	
MD	Machine Data

MDA	Manual Data Automatic: Manual input
MCS	Machine Coordinate System
MLFB	Machine-readable product designation
MMC	Man-Machine Communication: User interface on numerical control systems for operator control, programming and simulation
MPF	Main Program File: NC part program (main program)
MPI	Multi-Point Interface Multiport Interface
MCP	Machine Control Panel
NC	Numerical Control: Numerical control
NCK	Numerical Control Kernel: NC kernel with block preparation, traversing range, etc.
NCU	Numerical Control Unit: NCK hardware unit
ZO/WO	Zero/work offset
OEM	Original Equipment Manufacturer
OP	Operator Panel: Operating equipment
PCU	Programmable Control Unit
PCMCIA	Personal Computer Memory Card International Association: Plug-in memory normalization board
PG	Programming device
PLC	Programmable Logic Control: Adaptation control
REF	REFerence point approach function
REPOS	REPOSition function
ROV	Rapid Override : Input correction
RPA	R-Parameter Active: Memory area in NCK for R-NCK for R parameter numbers

SBL	Single Block : Single block
SD	Setting Data
SEA	Setting Data Active: Identifier (file type) for setting data
SK	Softkey
SKP	SKiP: Skip block
SPF	Sub Program File : Subprogram
SRAM	Static RAM (non-volatile)
SW	Software
SYF	SYstem Files System files
TEA	Testing Data Active: Identifier for machine data
TO	Tool Offset Tool offset
TOA	Tool Offset Active: Identifier (file type) for tool offsets
UFR	User Frame: Zero/work offset
FDD	Feed Drive
WCS	Workpiece coordinate system
TO	Tool offset
TC	Tool change
ZOA	Zero Offset Active: Identifier (file type) for work offset data

B Terms

Important terms are listed in alphabetical order. For terms, that appear in the explanation and for which there is a dedicated entry, reference is made using →.

A

Axes

In accordance with their functional scope, the CNC axes are subdivided into:

- Axes: Interpolating path axes
- Auxiliary axes: Non-interpolating feed and positioning axes with an axis-specific feed rate. Auxiliary axes are not involved in the actual machining, and include for example tool feeders and tool magazines.

Axis identifier

Axes are labeled in accordance with DIN 66217 (for a clockwise orthogonal → coordinate system) with the letters X,Y, Z.
→ Rotary axes which rotate about X,Y,Z are labeled with the letters A, B, C. Additional axes parallel to the above can be identified with further address letters.

Axis address

See → Axis identifier

Axis name

See → Axis identifier

Address

An address is the identifier for a certain operand or operand range, e.g., input, output, etc.

Alarms

All → messages and alarms are displayed on the operator panel in plain text with date and time as well as the appropriate symbol for the delete criterion. Alarms and messages are displayed separately.

1. Alarms and messages in the part program
Alarms and messages can be displayed directly from the part program in plain text.
2. Alarms and messages from PLC
Alarms and messages relating to the machine can be displayed directly from the PLC program in plain text. No additional function block packages are required for this purpose.

Drive

-
-

User-defined variable

Users can define variables in the → part program or data block (global user data) for their own use. A definition contains a data type specification and the variable name. See also → System variable.

User program	User programs for the S7-300 automation systems are created using the programming language STEP 7. The user program has a modular layout and consists of individual blocks. The basic block types are: Code blocks: These blocks contain the STEP 7 commands. Data blocks: These blocks contain the constants and variables for the STEP 7 program.
User memory	All programs and data, such as part programs, subprograms, comments, tool offsets, and zero offsets/frames, as well as channel and program user data, can be stored in the shared CNC user memory.
Working area limitation	With the aid of the working area limitation, the traversing range of the axes can be further restricted in addition to the limit switches. One value pair per axis may be used to describe the protected working area.
Working area	Three-dimensional zone into which the tool tip can be moved on account of the physical design of the machine tool. See also → Protection zone.
Working memory	The working memory is a RAM area in the → CPU which is accessed by the processor to access the user program during program execution.
Archive	Reading out data and/or directories to an external memory device.
A spline	The Akima spline runs under a continuous tangent through the programmed interpolation points (3rd order polynomial).
Automatic	Operating mode of the control (block sequence operation according to DIN): Operating Mode in NC systems in which a → part program is selected and continuously executed.
B	
Basic coordinate system	Cartesian coordinate system which is mapped by transformation onto the machine coordinate system. In the → part program, the programmer uses the axis names of the basic coordinate system. The basic coordinate system exists in parallel to the → machine coordinate system when no → transformation is active. The difference between the systems relates to the axis identifiers.
Baud rate	Rate of data transfer (Bit/s).
Machining channel	Via a channel structure, parallel sequences of movements, such as

	<p>positioning a loading gantry during machining, can shorten unproductive times. Here, a CNC channel must be regarded as a separate CNC control system with decoding, block preparation and interpolation.</p>
User interface	<p>The user interface (UI) is the display medium for a CNC control in the form of a screen. It is laid out with eight horizontal and eight vertical softkeys.</p>
Mode	<p>An operating concept on a SINUMERIK control. The operating modes → Jog, → MDI and → Automatic are defined.</p>
Mode group	<p>At all times all of the axles/spindles are assigned to precisely one channel. Each channel is assigned to one operating mode group. The channels of the mode group are always assigned the same → mode.</p>
Identifier	<p>In accordance with DIN 66025, words are supplemented using identifiers (names) for variables (arithmetic variables, system variables, user variables), subprograms, key words, and words with multiple address letters. These supplements have the same meaning as the words with respect to block format. Identifiers must be unique. It is not permissible to use the same identifier for different objects.</p>
B spline	<p>With the B spline, the programmed positions are not interpolation points, as they are just "control points" instead. The generated curve only runs near to the control points, not directly through them (optional 1st, 2nd or 3rd order polynomials).</p>
C	
C axis	<p>Axis around which the tool spindle describes a controlled rotational and positioning movement.</p>
CNC	<p>□ NC</p>
C spline	<p>The C spline is the most well-known and widely used spline. The transitions at the interpolation points are continuous, both tangentially and in terms of curvature. 3rd order polynomials are used.</p>
D	
Data block	<ol style="list-style-type: none">1. A data unit on the → PLC, which can be accessed by → HIGHSTEP programs.2. Data unit of the → NC: Data modules contain data definitions for global user data. These data can be initialized directly when they

are defined.

Data word

A data unit, two bytes in size, within a → data block.

Diagnostics

1. Operating area of the control.
2. The control has both a self-diagnostics program as well as test functions for servicing purposes: Status, alarm and service displays.

Services

Operating area of the control.

DRF

Differential Resolver Function: NC function which generates an incremental work offset in Automatic mode in conjunction with an electronic handwheel.

E**Editor**

The editor makes it possible to create, edit, extend, join, and import programs/texts/program blocks.

Rapid traverse

The highest traverse rate of an axis. It is used for example to move the tool from rest to the → workpiece contour or retract the tool from the contour.

Electronic handwheel

Electronic handwheels can be used to traverse the selected axes simultaneously in manual mode. The handwheel clicks are analyzed by the increment analyzer.

External work offset

A work offset specified by the →PLC.

F**Frame**

A frame is an arithmetic rule that transforms one Cartesian coordinate system into another Cartesian coordinate system. A frame contains the components → work offset, → rotation, → scaling, → mirroring.

G**Exact stop**

With a programmed exact stop instruction, the position stated in a block is approached precisely and very slowly, if necessary. To reduce the approach time, → exact stop limits are defined for rapid traverse and feed.

Exact stop limit

When all path axes reach their exact stop limits, the control responds as if it had reached its precise destination point. The → part program continues execution at the next block.

Geometry	Description of a → workpiece in the → workpiece coordinate system.
Geometry axis	Geometry axes are used to describe a 2- or 3-dimensional range in the workpiece coordinate system.
Velocity control	In order to achieve an acceptable traverse rate on very short traverse movements, predictive evaluation over several blocks (□ Look Ahead) can be set.
Linear interpolation	The tool travels along a straight line to the destination point while machining the workpiece.
Global main program/subprogram	Each global main program/subprogram may appear only once under its name in the directory. It is not possible to use the same program name in different directories with different contents as a global program.
H	
Main program	□ Part program identified by a number or name, in which other main programs, subprograms or → cycles may be called.
Auxiliary functions	Auxiliary functions can be used to transfer → parameters to the → PLC in → part programs, where they trigger reactions, which are defined by the machine manufacturer.
I	
Interpolator	Logical unit of the → NCK, which determines intermediate values for the movements to be traversed on the individual axes, on the basis of destination positions specified in the part program.
J	
Jog	Control operating mode (setup operation): In JOG mode, it is possible to set up the machine. Individual axes and spindles can be traversed in JOG mode by means of the direction keys. Other functions available in JOG mode are → reference point approach, → repositioning and → preset (setting an actual value).
K	
Channel	A channel can execute a → part program independently of the other channels. A channel exclusively controls the axes and spindles assigned to it. Part programs runs of various channels can be

	coordinated by → synchronization.
Channel structure	The channel structure makes it possible to process the → programs of individual channels simultaneously and asynchronously.
Contour	Outline of the → workpiece
Contour monitoring	The following error is monitored within a definable tolerance band as a measure of contour accuracy. Overloading of the drive, for example, may result in an unacceptably large following error. In such cases, an alarm is output and the axes are stopped.
Coordinate system	See → Machine coordinate system → Workpiece coordinate system
Offset memory	Data range in the control, in which the tool offset data are stored.
K_v	Servo gain factor, a control variable in a control loop.
L	
Linear axis	The linear axis is an axis, which, in contrast to a rotary axis, describes a straight line.
M	
Machine	Operating area of the control.
Machine axes	Physically existent axes on the machine tool.
Machine coordinate system	A coordinate system, which is related to the axes of the machine tool.
Machine zero	A fixed point on the machine tool, which can be referenced by all (derived) measuring systems.
Machine control panel	An operator panel on a machine tool with operating elements such as keys, rotary switches, etc., and simple indicators such as LEDs. It is used to directly influence the machine tool via the PLC.
Dimensions specification, metric and inches	Position and pitch values can be programmed in inches in the machining program. The control is set to a basic system regardless of the programmable dimensional specification (G70/G71).
MDA	Control operating mode: Manual Data Automatic. In the MDA mode, individual program blocks or block sequences with no reference to a main program or subprogram can be input and executed immediately afterwards through actuation of the NC start key.

Messages

All messages programmed in the part program and → alarms detected by the system are displayed on the operator panel in plain text with date and time, as well as the appropriate symbol for the delete criterion. Alarms and messages are displayed separately.

Metric measurement system

Standardized system of units: for lengths in millimeters (mm), meters (m), etc.

N**NC**

Numerical Control: Numerical control (NC) includes all components of machine tool control: → NCK, → PLC, → HMI □ COM.

Note: CNC (computerized numerical control) would be more appropriate for the SINUMERIK 840D or FM-NC controls: computerized numerical control.

NCK

Numerical Control Kernel: Component of the NC control, which executes → part programs and essentially coordinates the movements on the machine tool.

Zero/work offset

Specification of a new reference point for a coordinate system through reference to an existing origin and a → frame.

1. Settable

SINUMERIK 840D: A configurable number of settable work offsets are available for each CNC axis. The offsets - which are selected by means of G functions - take effect alternately.

2. External

In addition to all the offsets which define the position of the workpiece zero, an external work offset can be overlaid by means of the

- handwheel (DRF offset) or
- from the PLC.

3. Programmable

It is possible to program work offsets for all path and positioning axes by means of the TRANS statement.

O**OEM**

The scope for implementing individual solutions (OEM applications) for the SINUMERIK 840D has been provided for machine manufacturers, who wish to create their own operator interface or integrate process-oriented functions in the control.

Oriented spindle stop

Stops the workpiece spindle with a specified orientation angle, e.g., to perform an additional machining operation at a specific position.

Oriented tool retraction

RETTOOL: If machining is interrupted (e.g., when a tool breaks), a program command can be used to retract the tool in a user-specified orientation by a defined distance.

Override

Manual or programmable control feature, which enables the user to override programmed feedrates or speeds in order to adapt them to a specific workpiece or material.

P**Parameters**1. The **S7-300** uses two types of parameters:

- Parameters of a STEP 7 instruction A parameter of a STEP 7 instruction is the address of the operand to be edited or a constant.
- Parameter of a → parameter block
A parameter of a parameter block determines the behavior of a module.

	<p>2. 840D:</p> <ul style="list-style-type: none">- Operating area of the control.- Arithmetic parameter for which the programmer of the part program can assign or request values as required in the program.
PG	Programming device
PLC	Programmable Logic Control: → Programmable logic controller. Component of the → NC control: Programmable controller for processing the control logic of the machine tool.
PLC programming	The PLC is programmed with STEP 7 software. STEP 7 programming software is based on the standard WINDOWS operating system and incorporates the functionality of STEP 5 programming with innovative expansions and developments.
PLC program memory	SINUMERIK 840D: The PLC user program, the user data and the basic PLC program are stored together in the PLC user memory. The PLC user memory can be expanded up to 96 KB with memory expansions.
Polar coordinates	A coordinate system, which defines the position of a point on a plane in terms of its distance from the origin and the angle formed by the radius vector with a defined axis.
Polynomial interpolation	Polynomial interpolation provides a means of generating a very wide range of curves, including straight-line, parabolic and exponential functions (SINUMERIK 840D).
Positioning axis	Axis that performs an auxiliary movement on a machine tool (e.g., tool magazine, pallet transport). Positioning axes are axes that do not interpolate with path axes.
Power On	Control is switched off and then switched on again.
Preset	The control zero point can be redefined in the machine coordinate system by means of the Preset function. Preset does not cause the axes to move; instead, a new position value is entered for the current axis positions.
Program	<ol style="list-style-type: none">1. Operating area of the control.2. Sequence of instructions to the control.
Programmable working area limitation	Limitation of the motion space of the tool to a space defined by programmed limitations.

Programmable frames	Programmable → frames can be used to dynamically define new coordinate system starting points while the part program is running. A distinction is made between absolute definition using a new frame and additive definition with reference to an existing starting point.
CNC programming language	The CNC programming language is based on DIN 66025 with high-level language expansions. The → CNC high-level language and programming support the definition of macros (sequenced statements), for example.
R	
Reference point	Point on the machine tool used to reference the measuring system of the → machine axes.
Reference point approach	If the utilized distance measuring system is not an absolute value encoder then it is necessary to perform a reference point approach to ensure that the actual values returned by the measuring system match the machine coordinate values.
REPOS	<ol style="list-style-type: none"> 1. Reapproach contour, triggered by operator REPOS allows the tool to be returned to the interrupt position by means of the direction keys. 2. Programmed contour reapproach A selection of approach strategies are available in the form of program commands: Approach point of interruption, approach start of block, approach end of block, approach a point on the path between start of block and interruption.
Blank	Workpiece as it is before the part is machined.
Rotation	Component of a → frame, which defines a rotation of the coordinate system through a specific angle.
R parameters	Arithmetic parameters can be set or requested by the programmer of the → part program for any purpose in that program.
Rotary axis	Rotary axes apply a workpiece or tool rotation to a defined angular position.
Rotary axis, turning continuously	Depending on the application, the travel range of a rotary axis can be limited to less than 360 degrees or the axis can be continuously turned in both directions. Continuously turning rotary axes are used, for example, for eccentric machining, grinding and winding.
S	
Block	A section of a → part program terminated with a line feed. A

	distinction is made between → main blocks and → subblocks.
Block search	The block search function allows any point in the part program to be selected, at which machining must start or be continued. The function is provided for the purpose of testing part programs or continuing machining after a program abort.
Keywords	Words with a specific notation, which have a defined meaning in the programming language for → part programs.
Key-operated switch	<ol style="list-style-type: none">1. S7-300: The keylock switch is the mode selector switch on the <input type="checkbox"/> CPU. The keylock switch is operated by a removable key.2. 840D: The key-operated switch on the → machine control panel has 4 settings, to which functions are assigned by the operating system of the control. Further, the key-operated switch has three differently colored keys, which can be removed in the specified positions.
Tool nose radius compensation	Contour programming assumes that the tool is pointed. Since this is not actually the case in practice, the curvature radius of the tool used must be communicated to the control, which then takes it into account. The curvature center is maintained equidistantly around the contour, offset by the curvature radius.
Helical interpolation	The helical interpolation function is ideal for machining internal and external threads using form milling cutters and for milling lubrication grooves. The helix comprises two movements: <ol style="list-style-type: none">1. Circular movement in one plane2. Linear movement perpendicular to this plane
Increment	Travel path length specification based on number of increments. The number of increments can be stored as a → setting data or selected with keys labeled with 10, 100, 1000, 10,000.
Setting data	Data, which communicates the properties of the machine tool to the NC control, as defined by the system software.
Safety Functions	<p>The control incorporates monitors, which are active at all times and, which are designed to detect malfunctions in the → CNC, the programmable controller (→ PLC) and the machine at an early stage, in order to minimize the risk of damage to the tool, workpiece or machine.</p> <p>In the event of a fault, the machining operation is interrupted and the drives stopped. The cause of the malfunction is logged and output as an alarm. At the same time, the PLC is notified that a CNC alarm has been triggered.</p>

Scaling	Component of a → frame, which causes axis-specific alterations in the scale.
Softkey	A key, whose name appears on an area of the screen. The choice of softkeys displayed is dynamically adapted to the operating situation. The freely assignable function keys (softkeys) are assigned defined functions in the software.
Software limit switch	Software limit switches define the limits of the travel range of an axis and prevent the slide contacting the hardware limit switches. Two pairs of values can be assigned per axis and activated separately via the → PLC.
Mirroring	Mirroring reverses the signs of the coordinate values of a contour, with respect to an axis. It is possible to mirror with respect to more than one axis at a time.
Spindles	The spindle functionality is a two-level construct: <ol style="list-style-type: none">1. Spindles: Digital speed or position controlled spindle drives (SINUMERIK 840D)2. Auxiliary spindles: speed-controlled spindle drives, "auxiliary spindle" function package e.g. for driven tools.
Leadscrew error compensation	Compensation for the mechanical inaccuracies of a leadscrew participating in the feed. The control uses stored deviation values for the compensation.
Spline interpolation	Using the spline interpolation function, the control is able to generate a smooth curve from just a small number of specified interpolation points along a setpoint contour.
Languages	The user guidance display texts and the system messages are available in five system languages (diskette): German, English, French, Italian, and Spanish. The user can select two of the listed languages at a time in the control.
Standard cycles	Standard cycles are provided for machining operations, which are frequently repeated: <ul style="list-style-type: none">• Cycles for drilling/milling applications• for turning technology <p>The available cycles are listed in the "Cycle support" menu in the "Program" operating area. Once the desired machining cycle has been selected, the parameters required for assigning values are displayed in plain text.</p>

Synchronized axes	Synchronized axes take the same time to traverse their path as the geometry axes take for their path.
Synchronized Actions	<ol style="list-style-type: none">1. Auxiliary function output While a workpiece is being machined, technological functions (<input type="checkbox"/> auxiliary functions) can be output from the CNC program to the PLC. These auxiliary functions are used for example to control additional equipment for the machine tool, such as quills, grabbers, clamping chucks etc.2. High-speed auxiliary function output For time-critical switching functions, the acknowledgement times for the \rightarrow auxiliary functions can be minimized and unnecessary stops in the machining process can be avoided.
Synchronization	Instructions in \rightarrow part programs for coordination of the operations in different \rightarrow channels at specific machining points.
System variables	A variable, which exists, although it has not been programmed by the \rightarrow part program programmer. It is defined by a data type and the variable name preceded by the character \$. See also \rightarrow User-defined variable.
T	
Teach In	Teach-in is a means of creating or correcting part programs. The individual program blocks can be input via the keyboard and executed immediately. Positions approached via the direction keys or handwheel can also be stored. Additional information such as G functions, feedrates or M functions can be entered in the same block.
Part program	A sequence of instructions to the NC control which combine to produce a specific \rightarrow workpiece. Likewise, performing a certain machining operation on a specific \rightarrow blank.
Part program management	The part program management function can be organized according to \rightarrow workpieces. The size of the user memory determines the number of programs and the amount of data that can be managed. Each file (programs and data) can be given a name consisting of a maximum of 24 alphanumeric characters.
Text editor	<input type="checkbox"/> Editor
Transformation	Programming in a Cartesian coordinate system, execution in a non-Cartesian coordinate system (e.g., with machine axes as rotary axes).

U**Subprogram**

Sequence of statements of a → part program that can be called repeatedly with different defining parameters. The subprogram is called from a main program. Every subprogram can be protected against unauthorized read-out and display.

- Cycles are a type of subprogram.

Memory reset

The following → CPU memories are erased by a general reset operation:

- Working memory
- Read/write area of the → load memory
- System memory
- Backup memory

V**Variable definition**

A variable definition includes the specification of a data type and a variable name. The variable names can be used to access the value of the variables.

Traversing range

The maximum permissible travel range for linear axes is ± 9 decades. The absolute value depends on the selected input and position control resolution and the unit of measurement (inch or metric).

Feed override

The current feedrate setting entered via the control panel or by the PLC is overlaid on the programmed feedrate (0-200 %). The feedrate can also be corrected by a programmable percentage factor (1-200 %) in the machining program.

W**Workpiece**

Part to be made/machined by the machine tool.

Workpiece coordinate system

The starting position of the workpiece coordinate system is the → workpiece zero. In machining operations programmed in the workpiece coordinate system, the dimensions and directions refer to this system.

Workpiece zero

The workpiece zero is the starting point for the → workpiece coordinate system. It is defined by the distance from the machine zero.

Tool

A part used on the machine tool for machining. Examples include turning tools, milling cutters, drills, laser beams, etc.

Tool offset

By programming a **T function** (5 decades, integer) in the block, you can select the tool. Every T number can be assigned up to nine cutting edges (D addresses). The number of tools to be managed in the control is set at the configuration stage.

Tool radius compensation

In order to program a desired → workpiece contour directly, the control must traverse a path equidistant to the programmed contour, taking into account the radius of the tool used. (G41/G42).

Z**Inch measuring system**

Measuring system, which defines distances in inches and fractions of inches.

Access authorizations

The CNC program blocks and data are protected by a 7-level system of access restrictions:

- Three password levels for system manufacturers, machine manufacturers and users and
- Four keylock switch settings, which can be evaluated via the PLC.

Cycle support

The available cycles are listed in the "Cycle support" menu in the "Program" operating area. Once the desired machining cycle has been selected, the parameters required for assigning values are displayed in plain text.

Cycle

Protected subprogram for executing a repeated machining operation on the → workpiece

□

Index

I.1 Index

#

Recompile expansion 2-59

A

Accept MD from HMI-Embedded 7-380

Access rights 2-36

Acknowledgement symbols changed 8-395

Action log 8-414

Activate basic frame immediately 5-238

Activate timing 6-276

Activating user data 5-242

Actual value window 4-98

Alarm buffer 8-393

Alarm help 2-63

Alarms 8-394

Alignment channels 6-285

Archive 7-376

Arithmetic parameters 5-221

ASCII full view 6-281

Automatic 2-31, 4-132

Axes

Display active 8-397

Display all 8-397

Display feedrate 4-99

Display selected 8-397

B

Blank 2-26

Block display during program execution 4-155

Block search 4-141

Accelerated, external 4-145

In Program test mode 4-148

C

Chaining rule 5-173

Channel

active 2-61

Display status via symbols 4-89

interrupted 2-61

Reset 2-61

Channel operational messages 2-43

Channel switchover 2-61

Cleaning 10-441

Clipboard 7-376

CNC data structure 4-85

Communication error log 8-413

Configuration Data 8-413

Contour

Close 6-302

Graphical display 6-298

symbolic representation 6-292

Symmetrical elements 6-299

Contour calculator 6-287, 6-304

Contour definition programming 6-287

Contour element

Parameterize 6-296

Conversion inch/metric 2-62

Coordinate system

Graphical display 4-97

Coordinate system switchover 4-96

Coordinates, Cartesian/polar 6-303

CPF softkeys 2-40

Create workpiece directory 6-340

Cutting edge

Create new 5-179

Delete 5-180

CYCLE800 4-100

Cycles 6-253

Recompile 2-59

Support 6-313

D

Data selection 7-373

Define user data 5-239

Delete 6-351

Delete file 6-351, 7-369

Diagnostics

Drive 8-396

- Main screen 8-392
- Display
 - Auxiliary functions 4-101
 - Compile cycles 8-419
 - G functions 4-100
 - Machine status 2-43
 - Modal M functions 4-101
 - PLC status 8-421
 - Program control 2-48
 - Service 8-396
 - Spindles 4-103
 - System resources 8-412
 - Utilization 8-412
- Display auxiliary functions 4-101
- Display of machine data 9-432
- Display PLC status 8-421
- Display program blocks 4-133
- Display swivel data set 4-100
- Display transformations 4-100
- Display version 8-416
- Displaying machine data 9-432
- DRF (Differential Resolver Function) 4-156
- Drive optimization/test** 9-436
- Drives** 9-431
- DRY run feedrate 5-225
- Dual ASCII editor
 - Synchronized view 6-259
 - View 6-259
- Dwell time 2-44
- E**
 - Edit tool data 5-191
 - Editing a program 6-258
 - Editor help 2-63, 2-65
 - Electronic gear 5-229
 - EMERGENCY STOP button 2-31
 - Enabling 6-353
 - Extended help for program commands** 2-69
- F**
 - Feed override 2-33
 - File
 - Change properties 7-370
 - Copy 6-348, 7-368
 - Create new 7-367
 - Insert 6-348, 7-368
 - Load 7-367
 - Save 2-58
 - Unload 7-367
 - File functions 8-429, 9-433
 - File types 6-338
 - Find 2-57
 - Find path for program call 6-344
 - Flat D numbers 5-159
 - Following axis 5-229
 - Free contour programming 2-58
- G**
 - Geometry axes 4-96
 - Geometry processor → *Contour calculator* 6-287
 - Go to 2-57
 - Graphic model 6-332
 - Grinding data 5-198
- H**
 - Handwheel 4-104
 - Hard disk 4-137, 7-377
 - Hardkey assignment 2-29
 - Help
 - Context-sensitive 2-65
 - Machine data 2-63
 - Hierarchical file structure 7-374
 - HT 8 (Handheld Terminal) 2-39
- I**
 - Inc (increment) 4-118
 - Inch/Metric switchover 4-109
 - Increment (Inc) 2-32
 - Increment value 2-32
 - Information key 2-66, 2-69
 - Initialization program
 - User data, define 5-239
 - Insert a contour element 6-297
- J**
 - Job list 2-70
 - Execute 2-77
 - Syntax 2-72
 - JOG 2-31, 4-114
 - Continuous 5-223
 - Data 5-223
 - Feedrate 5-223
 - JOG main screen 4-114

K

Key

Acknowledge alarm 2-26
 ALT 2-27
 Backspace 2-26
 CTRL 2-27
 DEL (delete value) 2-27
 Edit 2-27
 End of line 2-27
 Expansion 2-25
 Inc 2-32
 Information 2-26
 INPUT 2-27
 MACHINE 2-25
 Recall 2-25
 SELECT 2-27
 Select window 2-26
 Selection 2-27
 SHIFT 2-25
 Switch over channel 2-25
 Switchover area 2-25
 TAB 2-27
 Undo 2-27

Key-operated switch 2-36

L

Leading axis 5-229
 Limit of data management 7-379
 Load 5-200
 From magazine list 5-204
 Load standard 6-343
 Loading list 4-136

M

MAC user data 5-240
 Machine axes 4-96
 Machine control panel 2-30
 Machine coordinate system 2-34, 4-96
 Machine data
 MA_SIMULATION_MODE (9480)18 6-335
 Machine functions 2-32, 4-86
 Machine status display 2-42
 Machine zero 5-230
 Machining list 6-279
 Magazine list 5-201
 Main screen
 Diagnostics 8-392

Program 6-256

Startup 9-430

Manage path labels 6-332

MDA 2-31, 4-127

MDA start screen 4-128

MDI

 Save program 4-129

Messages 8-394

MF 2 keyboard 2-29

Milling contour 6-299

Modes

 Automatic 4-132

 Change 4-91

 Group 4-88

 JOG 4-114

 MDA 4-127

 Overview 4-86

 Selection 4-91

Modes of operation 2-31

Multi-channel programs view 6-270

Multi-channel step sequence programming
 (option) 6-267

Multiple editor 6-281

N

NC card

 Delete data on... 7-370

 Read in data from... 7-363

 Read out data to... 7-364

NC memory:active data 7-376

NC Start, NC Stop 2-37

Network drive, external 4-138, 6-355

O

Operands

 Change value 8-422

 Delete value 8-422

 PLC status 8-428

Operating data 10-440

Operator focus 6-294

Output cycle versions 8-419

Overstore 4-150

Overwrite 2-56

P

Page down 2-26

Page up 2-26

- Parameter number for radius calculation 5-173
 - Part program 6-253
 - Continue 4-94
 - Create new 6-339
 - Load/unload 4-135
 - Start/Stop 4-94
 - Password 2-37
 - PLC 9-435
 - PLC addresses, symbolic 8-423
 - PLC status 9-435
 - Pocket calculator 2-62
 - Polar coordinates
 - Program contour element 6-302
 - Pre-assignment dialog box 6-285
 - Predefined package lists 8-417
 - Preset 4-107
 - Product overview 1-18
 - Program
 - Display levels 4-95, 4-133
 - Enable 6-353
 - execute 6-343
 - levels 4-133
 - Load 6-346
 - Load from hard disk 4-137
 - manage 6-337, 6-347
 - Select 6-343
 - store 6-253
 - Unload 6-346
 - Program control 2-37, 2-48, 4-152
 - Program editing 4-140
 - Program overview 4-134
 - Program protection *RO* 6-261
 - Program types 6-253
 - Program:simulate 6-314
 - Protection levels 2-36
 - Protection zones 5-228
 - Protocol 6-354
- Q**
- Quick help for program commands 2-66
 - Quick startup for drives/axes** 9-431
- R**
- R parameters 5-221
 - Delete 5-221
 - Edit 5-221
 - Find 5-221
 - Rapid traverse override 2-33, 2-34
 - Reference point approach 4-111
 - Remote diagnostics 8-394
 - Rename 6-352
 - Rename file 6-352
 - REPOS (Repositioning) 4-119
 - Reset 2-38
- S**
- Safety Integrated 4-120
 - Service SI 8-400
 - SI Communication 8-405
 - SI configuration 8-410
 - Save setup data 6-342
 - Scratching 4-121
 - Screen layout 2-42
 - Search target 4-141
 - Select a part program 6-316, 6-337, 6-339
 - Select block 2-56
 - Select contour element** 6-297
 - Selecting a workpiece 6-316, 6-337, 6-339
 - Service
 - Drive 8-399
 - SI (Safety Integrated) 8-400
 - Service axis 8-398
 - Service display 8-396
 - Services
 - Log 7-364
 - Main screen) 7-359
 - Manage data 7-366
 - Read in data 7-362
 - Read out data 7-363
 - Services main screen 7-359
 - Set date 9-435
 - Set defaults 6-343
 - Set time 9-435
 - Set tool offset to be active immediately 5-181
 - Setting
 - Editor 2-60, 6-313
 - Setting data 5-222
 - Display 5-227
 - Edit 5-227
 - Find 5-227
 - Setting-Daten 5-227
 - Settings
 - Downtimes 6-331
 - Simulation 2-59

- Drilling/milling 6-314
- Multi-channel step sequence display 6-277
- Network drive 6-336
- Orientable toolholder 6-337
- Reference points 6-333
- Set colors 6-332
- With multiple channels 6-277
- Simulation of complete turning operations 6-314
- Single block 2-37
- Skip levels, activate 4-153
- Softkey
 - Assignment 2-29
- Software version 8-414
- Special axes 4-96
- Spindle data 5-224
- Spindle number 5-173
- Spindle override 2-35
- Standard ASCII editor 6-258
- Standard full keyboard 2-29
- Starting angle for thread cutting 5-226
- Startup
 - Main screen 9-430
- Step sequence display
 - Collapsed 6-264
 - Expanded 6-264
 - Structure 6-263
- Subprogram 6-253
- Support
 - Free contour programming 6-307
- Switching between Cartesian/polar 6-303
- Switching on/switching off controller 1-20
- Symmetrical milling contour 6-299
- Synchronized Actions 4-105
- System frames
 - Display 4-123, 4-124
 - Protection levels 4-125
- System variables
 - Display 5-244
 - Log 5-248
- SZS Settable Zero System 5-238

T

- Teach In 4-127, 4-130
- Templates 6-254, 6-268
- Thread undercut (turning) 6-293
- Toggle between radius/diameter programming** 6-287

Tool

- Create new 5-176
- Delete 5-178
- Display 5-177
- Relocating 5-206
- Wear 5-195
- Tool cabinet 5-210
- Tool catalog 5-207
- Tool change time 6-325
- Tool data 5-159
 - Create 5-208
 - Display 5-208, 5-212
 - Edit 5-208, 5-212
- Tool management 9-431
 - Display 5-182
 - Main screen 5-183
- Tool management main screen 5-183
- Tool offset
 - Determine absolute coordinate 5-180
 - Main screen 5-174
 - Structure 5-159
- Tool offset data
 - Create 5-211
- Tool parameters
 - Specific 5-165
- Tool type 5-159
 - Drills 5-161
 - Grinding tools 5-162
 - Milling cutters 5-160
 - Slotting saw 5-166
 - Turning tools 5-165
- Tool zero 5-230
- Toolholder, orientable 6-337
- Transverse axis (turning) 4-98
- Traverse rate 4-117
- Traversing axes 4-117
- Traversing keys HT 8 2-40
- Turning contour
 - Chamfer 6-291
 - Radius 6-291

U

- Undercut (turning) 6-293
- Unload 5-204
- USB memory 7-376
- User agreement (option) 4-120
- User data 5-239

Edit/find 5-240

V

V.24 interface

Parameterizing 7-382

Using 7-386

Variable increment 5-223

Variable views

Create 5-245

Edit 5-245

Manage 5-247

Version

HMI 8-415

Save data 8-415

Software package 8-414

Version display

Cycles 8-416

Version number 8-414

Virtual keyboard HT 8 2-41

W

Work offset

Activate immediately 5-238

Active external 5-237

Active programmable 5-236

Active settable 5-235

Display 5-237

Settable 5-232

Working area limitation 5-222

Workpiece 6-253

Create new 6-339

Enable 6-353

Execute 6-343

Load/unload 4-135

Quantity 6-342

Workpiece coordinate system 2-34, 4-96

Z

Zero/work offset 5-230

I.2 Commands and Identifiers

G

GUD 5-239, 5-240

L

LOAD 2-72

LUD 5-239

M

Machine data

AUXFO_ASSOC_M1_VALUE (22256) 2-49

BASE_FUNCTION_MASK (30460) 4-98

DIAMETER_AX_DEF (20100) 6-293

MA_PRESET_MODE (9422) 4-108

MA_STAND_SIMULATION_LIMIT (9481) 6-335

MM_FRAME_FINE_TRANS (18600) 5-232

ON_NUM_SAFE_AXES (19120) 8-411

ON_NUM_SPL_IO (19122) 8-411

RESET_MODE_MASK (20110) 5-181

SAFE_FUNCTION_ENABLE (36901) 8-411

TECHNOLOGY (9020) 6-293

TOOL_CHANGE_TIME (10190) 6-325

USER_CLASS_TOA_WEAR (9202) 5-175

WPD_INI_MODE (11280) 6-344

WRITE_TOA_FINE_LIMIT (9450) 5-175

WRITE_ZOA_FINE_LIMIT (9451) 5-232

P

PUD 5-239

S

SEEDITOR.INI 6-263

SELECT 6-294

SERUPRO (Search RUn by PROgram test) 2-44

T

TCARR 4-100

To
 Siemens AG

 A&D MC MS1
 P.O. Box 3180

 91050 ERLANGEN, GERMANY

Fax +49 (0) 9131 / 98 – 63315 [documentation]

E-mail: docu.motioncontrol@siemens.com

<p><i>From</i></p> <p>Name: _____</p> <p>Address of your company/department</p> <p>Street: _____</p> <p>Postal code: _____ City: _____</p> <p>Phone: _____ / _____</p> <p>Telefax: _____ / _____</p>	<p>Suggestions</p>
	<p>Corrections</p> <p>For Publication/Manual:</p> <p>SINUMERIK 840Di sl/840D sl/840D</p> <p>HMI-Advanced</p> <p>User documentation</p>
	<p>Operating Manual</p> <p>Order No.: 6FC5398-2AP10-3BA0</p> <p>Edition: 01/2008</p>
	<p>Should you come across any printing errors when reading this publication, please notify us on this sheet. We are also thankful for any suggestions and improvements.</p>

Suggestions and/or corrections

