

SIEMENS

SIMATIC HMI

WinCC flexible 2008 Compact / Standard / Advanced

User's Manual

This manual is part of the documentation package with the order number 6AV6691-1AB01-3AB0.

Preface	
Introduction to WinCC flexible	1
WinCC flexible Engineering System	2
Working with projects	3
Working with Tags	4
Creating Screens	5
Creating an Alarm System	6
Working with a connection	7
Structure of a recipe management system	8
Logging and displaying tags	9
Working with reports	10
User administration	11
System functions and runtime scripting	12
Structure of Multilingual Projects	13
Project documentation	14
Mobile Wireless	15
Planning jobs	16
Managing project versions	17
Logging changes	18
Transfer	19
Integration of WinCC flexible in STEP 7	20
Appendix	21

Safety Guidelines

This manual contains notices you have to observe in order to ensure your personal safety, as well as to prevent damage to property. The notices referring to your personal safety are highlighted in the manual by a safety alert symbol, notices referring only to property damage have no safety alert symbol. These notices shown below are graded according to the degree of danger.

⚠ DANGER
indicates that death or severe personal injury will result if proper precautions are not taken.
⚠ WARNING
indicates that death or severe personal injury may result if proper precautions are not taken.
⚠ CAUTION
with a safety alert symbol, indicates that minor personal injury can result if proper precautions are not taken.
CAUTION
without a safety alert symbol, indicates that property damage can result if proper precautions are not taken.
NOTICE
indicates that an unintended result or situation can occur if the corresponding information is not taken into account.

If more than one degree of danger is present, the warning notice representing the highest degree of danger will be used. A notice warning of injury to persons with a safety alert symbol may also include a warning relating to property damage.

Qualified Personnel

The device/system may only be set up and used in conjunction with this documentation. Commissioning and operation of a device/system may only be performed by **qualified personnel**. Within the context of the safety notes in this documentation qualified persons are defined as persons who are authorized to commission, ground and label devices, systems and circuits in accordance with established safety practices and standards.

Prescribed Usage

Note the following:

⚠ WARNING
This device may only be used for the applications described in the catalog or the technical description and only in connection with devices or components from other manufacturers which have been approved or recommended by Siemens. Correct, reliable operation of the product requires proper transport, storage, positioning and assembly as well as careful operation and maintenance.

Trademarks

All names identified by ® are registered trademarks of the Siemens AG. The remaining trademarks in this publication may be trademarks whose use by third parties for their own purposes could violate the rights of the owner.

Disclaimer of Liability

We have reviewed the contents of this publication to ensure consistency with the hardware and software described. Since variance cannot be precluded entirely, we cannot guarantee full consistency. However, the information in this publication is reviewed regularly and any necessary corrections are included in subsequent editions.

Preface

Purpose of this manual

This user manual is part of the WinCC flexible documentation. The manual provides you with a complete overview of configuring with WinCC flexible. The manual supports you in creating new projects, in the procedure used during configuration and in transferring a project to an HMI device.

The manual is intended for newcomers, operators and configuration engineers involved in configuration, commissioning, installation and service with WinCC flexible.

The help integrated in WinCC flexible, the WinCC flexible Information System, contains detailed information. The information system contains instructions, examples and reference information in electronic form.

Basic Knowledge Requirements

General knowledge in the field of automation engineering is required to understand this manual.

You should also have experience of using PCs running under the Windows 2000 or Windows XP operating systems. A knowledge of VBA or VBS is required for advanced configuration by using scripts.

Scope of the manual

This manual is valid for the WinCC flexible 2008 software package.

Position in the information scheme

This manual is part of the SIMATIC HMI documentation. The information below presents an overview of the information landscape of SIMATIC HMI.

User manual

- WinCC flexible Micro
 - describes the engineering basics based on the WinCC flexible Micro engineering system (ES)
- WinCC flexible Compact/ Standard/ Advanced
 - describes the engineering basics based on the WinCC flexible Compact, WinCC flexible Standard and WinCC flexible Advanced engineering systems (ES)
- WinCC flexible Runtime:
 - Describes how to commission and operate your Runtime project on a PC.

- WinCC flexible Migration:
 - Describes how to convert an existing ProTool project to WinCC flexible.
 - Describes how to convert an existing WinCC project to WinCC flexible.
 - Describes how to migrate ProTool projects with an HMI migration from OP3 to OP 73 or OP 73 micro.
 - Describes how to migrate ProTool projects with an HMI migration from OP7 to OP 77B or OP 77A.
 - Describes how to migrate ProTool projects with an HMI migration from OP17 to OP 177B.
 - Describes how to migrate ProTool projects with HMI migration from RMOS graphic devices to Windows CE devices.
- Communication:
 - Communication Part 1 describes the connection of the HMI device to SIMATIC PLCs.
 - Communication Part 2 describes the connection of the HMI device to third-party PLCs.

Operating Instructions

- Operating instructions for SIMATIC HMI devices:
 - OP 73, OP 77A, OP 77B
 - TP 170micro, TP 170A, TP 170B, OP 170B
 - OP 73micro, TP 177micro
 - TP 177A, TP 177B, OP 177B
 - TP 270, OP 270
 - TP 277, OP 277
 - MP 270B
 - MP 370
 - MP 377
- Operating instructions for mobile SIMATIC HMI devices:
 - Mobile Panel 170
 - Mobile Panel 277
 - Mobile Panel 277F IWLAN
 - Mobile Panel 277 IWLAN
- Operating instructions (compact) for SIMATIC HMI devices:
 - OP 77B
 - Mobile Panel 170

Getting Started

- WinCC flexible for first time users:
 - Based on a sample project, this is a step-by-step introduction to the basics of configuring screens, alarms, and recipes, and screen navigation.
- WinCC flexible for advanced users:
 - Based on a sample project, this is a step-by-step introduction to the basics of configuring logs, project reports, scripts, user management, and multilingual projects, and integration into STEP 7.
- WinCC flexible options:
 - Based on a sample project, this is a step-by-step introduction to the basics of configuring the WinCC flexible Audit, Sm@rtServices, Sm@rtAccess and OPC Server options.

Online availability

The following link actively guides you to technical documentation for SIMATIC products and systems in different languages.

- SIMATIC Guide Technical Documentation:

http://www.automation.siemens.com/simatic/portal/html_76/techdoku.htm

This Manual

Structure of this manual:

- Introduction to WinCC flexible – Chapter 1
- Working with WinCC flexible – Chapters 2 -17
- Transferring a project to an HMI device – Chapter 18
- Integration of WinCC flexible in STEP 7 – Chapter 19
- Appendix – Chapter 20

Conventions

A distinction is made in the naming conventions for the configuration and runtime software:

- "WinCC flexible 2008" refers to the configuration software.
- "Runtime" designates the runtime software running on the HMI devices.
- "WinCC flexible Runtime" designates the visualization product for use on standard PCs or panel PCs.

The term "WinCC flexible" is used in the general context. A version name such as "WinCC flexible 2008" is used whenever it is necessary to distinguish it from other versions.

The following formatting is used to facilitate reading of the manual:

Notation	Scope
"Add screen"	<ul style="list-style-type: none">• Terminology that occurs in the user interface, e.g., dialog names, tabs, buttons, menu commands.• Inputs required, e.g., limit values, tag values• Path information
"File > Edit"	Operational sequences, e.g., menu commands/shortcut menu commands.
<F1>, <Alt>+<P>	Keyboard inputs

Please pay particular attention to such notices:

Note

Notes containing important information about the product and its use or a specific section of the documentation to which you should pay particular attention.

Trademarks

HMI®
SIMATIC®
SIMATIC HMI®
SIMATIC ProTool®
SIMATIC WinCC®
SIMATIC WinCC flexible®

Third parties using for their own purposes any other names in this documentation which refer to trademarks might infringe upon the rights of the trademark owners.

Additional support

Representatives and offices

If you have questions concerning the use of the described product which are not answered in this manual, please contact the Siemens representative in your area.

Find your contact partner at:

<http://www.siemens.com/automation/partner>

A guide to the technical documentation for the various SIMATIC products and systems is available at:

<http://www.siemens.com/simatic-tech-doku-portal>

The online catalog and the online ordering system is available at:

<http://mall.automation.siemens.com>

Training center

To familiarize you with automation systems, we offer a variety of courses. Please contact your regional training center or the central training center in D-90327 Nuremberg, Germany.

Phone: +49 (911) 895-3200

Internet: <http://www.sitrain.com>

Technical support

You can reach the technical support for all A&D products

via the support request form on the web:

<http://www.siemens.com/automation/support-request>

Phone: + 49 180 5050 222

Fax: + 49 180 5050 223

Additional information about our technical support is available in the Internet at:

<http://www.siemens.com/automation/service>

Service & support on the Internet

In addition to our documentation, we offer our complete knowledge base on the Internet at.

<http://www.siemens.com/automation/service&support>

There you will find:

- The newsletter which provides the latest information on your products.
- Relevant documentation for your application, which you can access via the search function in our service & support database.
- A forum where users and experts from all over the world exchange ideas.
- You local Automation & Drives representative.
- Information about on-site service, repairs, spare parts. Much more can be found on our "Services" pages.

Table of contents

	Preface	3
1	Introduction to WinCC flexible.....	19
1.1	Introduction to SIMATIC HMI	19
1.2	WinCC flexible system overview.....	20
1.2.1	Components of WinCC flexible	20
1.2.2	WinCC flexible Engineering System	21
1.2.3	WinCC flexible Runtime	23
1.2.4	Available options	23
1.2.5	Licensing.....	25
1.2.5.1	Licenses and License Key	25
1.2.5.2	WinCC flexible without licensing	26
1.3	Automation concepts	26
1.3.1	Automation concepts with WinCC flexible	26
1.3.2	Remote access to HMI devices	29
1.3.3	Automatic alarm dispatch.....	30
1.3.4	Distributed HMI	31
1.3.5	Supporting personal HMI devices	32
1.3.6	Modular Machine Concepts	32
1.4	Configuration concepts	33
1.4.1	Configuration Support	33
1.4.2	Scalable Configuration Tools	34
1.4.3	PLC-independent configuration	35
1.4.4	Use.....	35
1.4.5	Intelligent tools	36
1.4.5.1	Bulk data processing.....	36
1.4.5.2	Configuring movement paths.....	37
1.4.5.3	Graphic Configuration of the Screen Navigation	37
1.4.6	Totally Integrated Automation	39
2	WinCC flexible Engineering System	41
2.1	Basic Principles on the Programming Interface.....	41
2.2	WinCC flexible user interface.....	42
2.2.1	WinCC flexible User Interface Elements.....	42
2.2.2	Menus and Toolbars	44
2.2.3	Work area.....	45
2.2.4	Project View	46
2.2.5	Property view	47
2.2.6	Library	48
2.2.7	Output View.....	49
2.2.8	Object view.....	50
2.3	Placing editor-specific operating elements	51
2.4	Working with windows and toolbars.....	52
2.5	Working with the Mouse.....	54

2.6	Keyboard control	56
2.7	Working with WinCC flexible	57
2.7.1	Working with WinCC flexible	57
2.7.2	Working with projects	58
2.7.3	Editing Multiple Projects with WinCC flexible	58
2.7.4	Functional scope of a project	59
2.7.5	Editor Properties	60
2.7.6	Open Editor	61
2.7.7	Switching between editors	62
2.7.8	Object List	64
2.7.9	Function List	65
2.7.10	Text List	67
2.7.11	Graphics list	72
2.7.12	Displaying Help	76
2.7.13	Customized setup of WinCC flexible	77
2.8	WinCC flexible Start Center	78
3	Working with projects	81
3.1	Basis for working with projects	81
3.1.1	Working with projects	81
3.1.2	Component parts of a project	83
3.2	Types of projects	83
3.2.1	Types of projects	83
3.2.2	HMI device dependency of projects	85
3.2.3	Configuring a project for several HMI devices	87
3.2.4	Creating a project for use on different operating units	89
3.2.5	WinCC flexible integrated in SIMOTION and STEP7	90
3.3	Multilingual configuration	92
3.4	Editing projects	94
3.4.1	Editing projects	94
3.4.2	Displaying projects	96
3.4.3	Working in the Project View	98
3.4.4	Working in the Object View	99
3.4.5	Migrating existing projects	100
3.5	Converting projects	100
3.5.1	Projects of different WinCC flexible versions	100
3.5.2	Differences between projects of different WinCC flexible versions	102
3.5.3	Differentiation of HMI-device versions	104
3.6	Reusing project data	105
3.6.1	Copying mechanisms	105
3.6.2	Flat copy	106
3.6.3	Copy	107
3.6.4	Replace	108
3.6.5	Using libraries	110
3.6.6	Using faceplates	110
3.7	Working with the cross-reference	111
3.8	Overview of rewire	112
3.9	Internal project find and replace feature	112
3.10	Basic principles on documentation in WinCC flexible	113

3.11	Consistency check during generation	113
3.12	Debugging projects	115
3.13	Transferring projects	116
3.13.1	Basic Principles of the Transfer Operation	116
3.13.2	Back transfer of projects	118
4	Working with Tags	121
4.1	Basics.....	121
4.1.1	Basics of tags.....	121
4.1.2	External tags	122
4.1.3	Internal Tags	123
4.2	Elements and basic settings	124
4.2.1	Tag editor	124
4.2.2	Basic Settings for Tags and Arrays	125
4.3	Working with Tags	127
4.3.1	Properties of a Tag	127
4.3.2	Communication with the PLC using external tags	128
4.3.3	Changing the tag configuration	130
4.3.4	Tag limit values	130
4.3.5	Start value of a tag.....	131
4.3.6	Updating the Tag Value in Runtime	131
4.3.7	Data logging	132
4.3.8	Linear scaling a tag.....	133
4.3.9	Indirect addressing of tags.....	134
4.4	Array basics	135
4.5	Examples of arrays	137
4.6	Cycle basics	138
4.7	Working with structures.....	139
4.7.1	Structure basics	139
4.7.2	Structures Editor	141
4.7.3	Managing structures	142
4.8	Importing Tags	144
4.8.1	Importing and exporting tags	144
4.8.2	Settings for exporting and importing tags	145
4.8.3	Format of the connection data	147
4.8.4	Format of the tag data.....	149
5	Creating Screens	153
5.1	Basics.....	153
5.1.1	Screen Basics	153
5.1.2	HMI-based dependency of screens	155
5.1.3	"Screens" Editor	157
5.1.4	Procedures.....	158
5.2	Configuring the navigation system.....	159
5.2.1	Navigating options	159
5.2.2	Graphic programming of the screen navigation system	159
5.2.3	Using the navigation control.....	162
5.3	Working with objects	163
5.3.1	Overview of Objects.....	163
5.3.2	Editing options of objects	167

5.3.3	Repositioning and resizing multiple objects	168
5.3.4	External graphics	168
5.3.5	Object Groups	170
5.3.6	Defining group properties	171
5.4	Options of assigning dynamic update functions	172
5.5	Working with function keys	173
5.6	The Advantage of Layers	175
5.7	Object Libraries	176
5.8	Working with faceplates	178
5.8.1	Faceplate basics	178
5.8.2	Dynamic control options	180
6	Creating an Alarm System	181
6.1	Basics	181
6.1.1	Visualization of process and system alarms	181
6.1.2	User-defined alarms	182
6.1.2.1	Available Alarm Procedures	182
6.1.2.2	Acknowledging Alarms	183
6.1.2.3	Alarm classes	184
6.1.3	System alarms	185
6.1.4	Displaying Alarms	186
6.1.4.1	Displaying Alarms on the HMI Device	186
6.1.4.2	Filtering the display of alarms	187
6.1.4.3	Logging and reporting alarms	188
6.1.4.4	System Functions for Alarm Editing	188
6.2	Elements and basic settings	190
6.2.1	Alarm Components and Properties	190
6.2.2	Editors for Configuring Alarms	191
6.2.2.1	Basic Principles of Editors	191
6.2.2.2	"Discrete alarms" editor	193
6.2.2.3	"Analog alarms" editor	194
6.2.2.4	"System alarms" editor	195
6.2.2.5	"Alarm classes" editor	196
6.2.2.6	"Alarm groups" editor	197
6.2.2.7	Basic Settings for the Alarm System	198
6.3	Working with alarms	199
6.3.1	Reporting alarms	199
6.3.2	Integrating alarms with the alarm numbering procedure	199
6.4	Alarm logging	202
6.4.1	Basic principles of alarm logging	202
6.4.2	Alarm logging	203
6.4.3	"Alarm logs" editor	204
6.4.4	Basic settings for alarm logs	205
6.4.5	Alarm logging	207
6.4.6	Displaying logged alarms on screens	207
6.4.7	Structure of a *.csv file with alarms	208
6.4.8	Accessing the ODBC log database directly	209
7	Working with a connection	211
7.1	Basics	211
7.1.1	Communication basics	211
7.1.2	Principles of communication	212

7.2	Elements and basic settings	214
7.2.1	Connections Editor.....	214
7.2.2	Parameters for connections.....	215
7.2.3	Area pointers for connections	216
7.3	Connection and Protocols.....	217
7.4	Ethernet connection	220
7.5	SNMP and MIB on HMIs.....	221
8	Structure of a recipe management system	223
8.1	Basics.....	223
8.1.1	Basic principles of recipes	223
8.1.2	Example for using recipes.....	224
8.1.3	Structure of recipes	225
8.1.4	Display of recipes.....	226
8.1.5	Transfer of recipe data records.....	227
8.1.6	Configuration of recipes	230
8.1.7	Special features of the OP 77A and TP 177A	232
8.1.8	Synchronization of recipe data records with the PLC	235
8.2	Elements and basic settings	236
8.2.1	"Recipes" editor.....	236
8.2.2	Recipe elements	237
8.2.3	Recipe data records.....	239
8.2.4	Recipe settings.....	240
8.3	Viewing and editing recipes in Runtime.....	242
8.3.1	Recipe screen and recipe view	242
8.3.2	Recipe view.....	242
8.3.3	Configuration options for the recipe view.....	244
8.3.4	Behavior of the recipe view in Runtime	247
8.3.5	Recipe screen	248
8.3.6	Operator input of the recipe view	250
8.3.7	Operator input of the simple recipe view	252
8.3.8	Reactions to modifications of the recipe structure	255
8.4	Scenarios	256
8.4.1	Scenario: Entering recipe data records in Runtime	256
8.4.2	Scenario: Manual production sequence	257
8.4.3	Scenario: Automatic production sequence	258
9	Logging and displaying tags	261
9.1	Basics.....	261
9.1.1	Basic principles for data logging	261
9.1.2	Data logging in WinCC flexible	261
9.1.3	Trends	263
9.2	Elements and basic settings	265
9.2.1	"Data Logs" editor	265
9.2.2	Basic settings for data logs.....	266
9.3	Logging tab values.....	268
9.4	Outputting logged data.....	269
9.4.1	Outputting tag values in screens.....	269
9.4.2	The structure of a *.csv file with tag values	270
9.4.3	Accessing the ODBC log database directly	271

10	Working with reports	273
10.1	Principles on the report system.....	273
10.2	Structure of reports	274
10.3	Elements and basic settings	276
10.3.1	Editor "reports"	276
10.3.2	Using the toolbox view	277
10.4	Working with reports	278
10.4.1	Creating a report	278
10.4.2	Adapting the report properties	279
10.4.3	Objects for report creation.....	281
10.4.4	Use of report objects.....	282
10.5	Reporting alarms.....	283
10.5.1	Reporting alarms.....	283
10.5.2	Process output parameters for an alarm protocol.....	284
10.6	Reporting recipes	287
10.6.1	Reporting recipes	287
10.6.2	Editing output parameters for a recipe report	288
10.7	Outputting a report	291
11	User administration.....	293
11.1	Field of application of the user administration.....	293
11.2	Structure of the user administration	294
11.3	Elements and basic settings	295
11.3.1	"Users" user administration.....	295
11.3.2	"Groups" user administration	296
11.3.3	Users work area	298
11.3.4	User groups work area.....	299
11.3.5	Runtime security settings.....	300
11.4	Working with the user administration	302
11.4.1	Central user administration using SIMATIC Logon.....	302
11.4.2	Users in Runtime.....	304
11.4.3	User view	305
11.4.4	Access security	306
12	System functions and runtime scripting	307
12.1	Basics.....	307
12.1.1	System functions and runtime scripting	307
12.1.2	System functions.....	308
12.1.3	Use of system functions	310
12.1.4	Scripts	310
12.1.5	Use of scripts	311
12.2	Working with function lists.....	312
12.2.1	Basic principles of the functions list	312
12.2.2	Properties of a function list.....	313
12.3	Elements and basic settings	314
12.3.1	"Script" editor	314
12.3.2	Properties of the "Script" editor.....	316
12.3.3	Basic settings	319
12.4	Creating scripts	321

12.4.1	Access to tags.....	321
12.4.2	Call up of scripts and system functions in the scripts.....	322
12.4.3	Access to objects.....	323
12.4.4	Synchronization of tags and objects.....	324
12.4.5	Store script.....	324
12.5	Debugging.....	325
12.5.1	Debugging Scripts.....	325
12.5.2	Integrating the debugger.....	326
12.6	Runtime behavior of functions in runtime.....	331
12.6.1	Completion of the function list in runtime.....	331
12.6.2	Processing of scripts in runtime.....	332
12.6.3	Delivery and return of values.....	333
12.6.4	Changing of object properties in runtime with VBS.....	334
12.6.5	HMI device dependent system functions in the script.....	334
13	Structure of Multilingual Projects.....	335
13.1	Working with multiple languages.....	335
13.2	WinCC flexible terminology.....	336
13.3	Language Settings.....	338
13.3.1	Language settings in the operating system.....	338
13.3.2	Operating system settings for Asian languages.....	339
13.3.3	"Project Languages" editor.....	339
13.4	Creating a project in multiple languages.....	341
13.4.1	Creating a project in multiple languages.....	341
13.4.2	Specific features of Asian and Eastern languages in the engineering system.....	342
13.4.3	Translating project texts in the editor.....	343
13.4.4	"Project texts" editor.....	344
13.4.5	Exchanging texts with translators.....	345
13.5	Working with dictionaries.....	347
13.5.1	Working with dictionaries.....	347
13.5.2	"System dictionary" editor.....	348
13.5.3	"User dictionary" editor.....	349
13.6	Use of language-dependent graphics.....	350
13.6.1	Use of language-dependent graphics.....	350
13.6.2	"Graphics" editor.....	351
13.7	Languages in Runtime.....	352
13.7.1	Languages in Runtime.....	352
13.7.2	Configuring language switching.....	353
13.7.3	Specific features of Asian and Eastern languages in Runtime.....	353
14	Project documentation.....	355
14.1	Basics.....	355
14.1.1	Project documentation.....	355
14.1.2	Structure of a layout.....	356
14.2	Using layouts.....	357
14.2.1	Using layouts.....	357
14.2.2	Editing a layout for the project documentation.....	358
14.3	Creating a project report.....	360
14.3.1	Selecting the data for a project report.....	360
14.3.2	Outputting of data of selected objects.....	360

14.3.3	Selecting Objects for the Project Documentation	361
15	Mobile Wireless	363
15.1	Basic principles	363
15.1.1	Field of application for the Mobile Panel Wireless	363
15.1.2	How the Mobile Panel Wireless works	364
15.2	Elements and basic settings	368
15.2.1	Zones	368
15.2.2	Zones working area	369
15.2.3	Effective ranges	370
15.2.4	Effective ranges working area	371
15.3	Working with effective ranges	373
16	Planning jobs	375
16.1	Field of application of the scheduler	375
16.2	Working with jobs and events	376
16.3	Elements	378
16.3.1	"Scheduler" editor	378
16.3.2	Work area of the "Scheduler" editor	379
17	Managing project versions	381
17.1	Applications for project versioning	381
17.2	Basics of version management	382
17.3	Trunk	383
17.4	Branch	384
17.5	Elements	385
17.5.1	"Project versions" editor	385
17.5.2	Change log operator controls	386
17.5.3	Version Management Work Area	387
17.5.4	Property view	388
17.6	Working with project versions	389
17.6.1	Comparing versions	389
18	Logging changes	391
18.1	Applications for the change log	391
18.2	Change log of a project	392
18.3	Change log of a project	393
18.4	Change log of a project under version management	395
18.5	Elements	396
18.5.1	"Change log" editor	396
18.5.2	Change log operator controls	397
18.5.3	Change log work area	398
19	Transfer	399
19.1	Basics	399
19.1.1	Basic Principles of the Transfer Operation	399
19.1.2	Transfer settings	401
19.1.3	Transfer via USB	404
19.1.4	Back transfer of projects	404

19.2	Managing Files on the HMI Device	407
19.2.1	ProSave	407
19.2.2	Backup of HMI data	408
19.2.3	Updating the operating system	409
19.2.4	Transferring authorizations	410
19.2.5	Installation of options	410
20	Integration of WinCC flexible in STEP 7	411
20.1	Basic Principles.....	411
20.1.1	Restrictions for integrated projects	411
20.1.2	Converting integrated projects	411
20.1.3	Basic principles of integration in STEP 7	412
20.1.4	Working with the SIMATIC Manager	414
20.1.5	Working with HW Config	414
20.1.6	Configuring connections	415
20.1.7	Working with objects	416
20.1.8	Converting an integrated project.....	418
20.1.8.1	Conversion of integrated WinCC flexible projects in STEP 7	418
20.1.8.2	Converting an integrated project to the current WinCC flexible version	420
20.1.8.3	Converting an integrated project to an earlier WinCC flexible version	421
20.1.9	Integrating WinCC flexible in a PC Station	422
20.2	Configuring communication settings	424
20.2.1	Configuring communication settings via routing	424
20.2.2	Project transfer via S7 routing.....	425
20.3	Tag configuration	429
20.3.1	Configuring tags with the Tag editor	429
20.3.2	Connecting a tag via the application point	431
20.4	Configuring alarms.....	432
20.4.1	Integrating alarms with the alarm numbering procedure	432
21	Appendix.....	435
21.1	Open Source Software.....	435
21.2	Performance features	435
21.2.1	General Technical Data	435
21.2.1.1	Released operating systems.....	435
21.2.1.2	Released databases	436
21.2.1.3	Further software versions supported	436
21.2.1.4	Recommended printers.....	436
21.2.1.5	Legal characters	437
21.2.1.6	Memory requirement of recipes	437
21.2.1.7	Memory space requirements for recipes of special devices	438
21.2.2	System limits	440
21.2.2.1	System limits	440
	Index.....	453

Introduction to WinCC flexible

1.1 Introduction to SIMATIC HMI

Introduction

Maximum transparency is essential for the operator who works in an environment where processes are becoming more complex, and requirements for machine and plant functionality are increasing. The Human Machine Interface (HMI) provides this transparency.

The HMI system represents the interface between man (operator) and process (machine/plant). The PLC is the actual unit which controls the process. Hence, there is an interface between the operator and WinCC flexible (at the HMI device) and an interface between WinCC flexible and the PLC. An HMI system assumes the following tasks:

- Process visualization
The process is visualized on the HMI device. The screen on the HMI device is dynamically updated. This is based on process transitions.
- Operator control of the process
The operator can control the process by means of the GUI. For example, the operator can preset reference values for the controls or start a motor.
- Displaying alarms
Critical process states automatically trigger an alarm, for example, when the setpoint value is exceeded.
- Archiving process values and alarms
The HMI system can log alarms and process values. This feature allows you to log process sequences and to retrieve previous production data.
- Process values and alarms logging
The HMI system can output alarms and process value reports. This allows you to print out production data at the end of a shift, for example.
- Process and machine parameter management
The HMI system can store the parameters of processes and machines in recipes. For example, you can download these parameters in one pass from the HMI device to the PLC to change over the product version for production.

SIMATIC HMI

SIMATIC HMI offers a totally integrated, single-source system for manifold operator control and monitoring tasks. With SIMATIC HMI, you always master the process and always keep your machinery and units running.

Examples of simple SIMATIC HMI systems are small touch panels for use at machine level.

SIMATIC HMI systems used for controlling and monitoring production plants represent the upper end of the performance spectrum. These include high-performance client/server systems.

Integration of SIMATIC WinCC flexible

WinCC flexible is the HMI software for future-proof machine-oriented automation concepts with comfortable and highly efficient engineering. WinCC flexible combines the following benefits:

- Straightforward handling
- Transparency
- Flexibility

1.2 WinCC flexible system overview

1.2.1 Components of WinCC flexible

WinCC flexible Engineering System

The WinCC flexible Engineering System is the software for handling all your essential configuring tasks. The WinCC flexible edition determines which HMI devices in the SIMATIC HMI spectrum can be configured.

WinCC flexible Runtime

WinCC flexible Runtime is your software for process visualization. You execute the project in process mode in Runtime.

WinCC flexible options

The WinCC flexible options allow you to expand the standard functionality of WinCC flexible. A separate license is needed for each option.

1.2.2 WinCC flexible Engineering System

Introduction

WinCC flexible is an engineering system for all your configuring tasks. WinCC flexible has a modular design. With each higher edition you expand the spectrum of supported devices and WinCC flexible functionality. You can always migrate to a higher edition by means of a PowerPack.

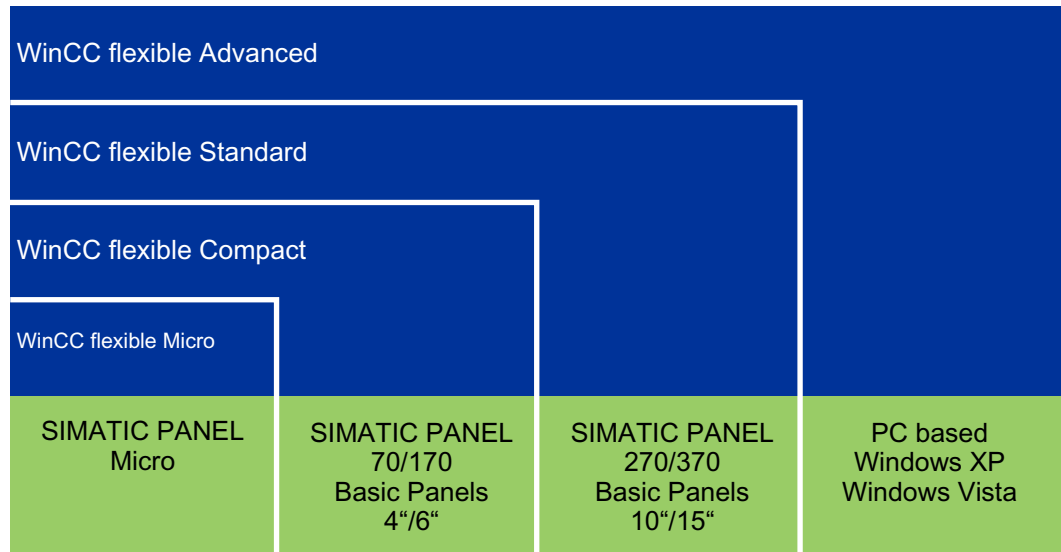

WinCC flexible covers a performance spectrum ranging from Micro Panels to simple PC visualization. The WinCC flexible functionality is thus comparable with that of products of the ProTool family and the TP Designer. You can integrate your existing ProTool projects into WinCC flexible.

Principle

The WinCC flexible workbench opens on the screen of your programming computer when you create a new or open an existing project in WinCC flexible. The project structure is visualized and the project managed in the "Project View."

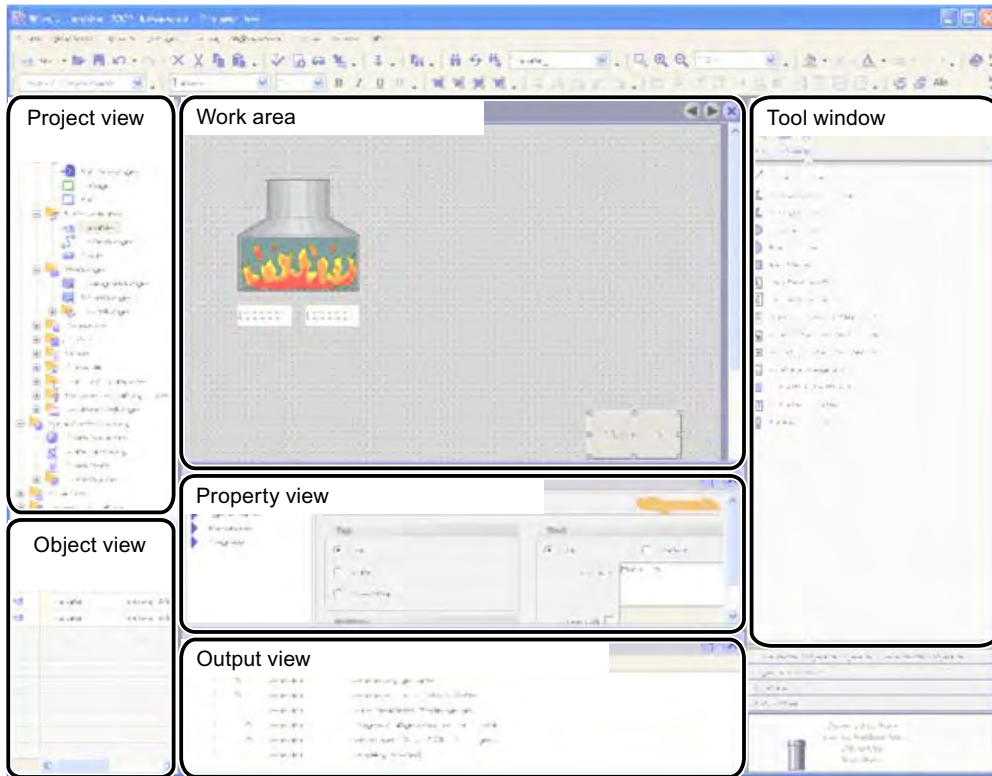

WinCC flexible provides a special editor for each configuring task. For example, you configure the GUI of an HMI device in the "Screens" editor. Or you can use the "Discrete Alarms" editor to configure alarms.

All project configuration data related to a project is stored in the project database.

Migration to another WinCC flexible edition

Your current WinCC flexible edition determines which HMI devices you can configure. To configure an HMI device which is not supported in your current WinCC flexible edition, you can migrate to another WinCC flexible edition. All existing functions remain available.

As of the WinCC flexible Compact edition, you can use the PowerPack to upgrade the WinCC flexible edition.

WinCC flexible Asia editions

Only the "Advanced" and "Standard" editions are available for the WinCC flexible ASIA version.

1.2.3 WinCC flexible Runtime

Principle

In runtime, the operator can control and monitor the process. This involves in particular the following tasks:

- Communication with the automation systems.
- On-screen visualization of images
- Operating the process, for example, by setting setpoint values or opening and closing valves.
- Archiving of current runtime data, e.g. process values and alarm events.

Performance spectrum of WinCC flexible Runtime

WinCC flexible Runtime supports a certain number of process variables (Powertags) which is determined by your license:

- WinCC flexible Runtime 128: Supports 128 process variables
- WinCC flexible Runtime 512: Supports 512 process variables
- WinCC flexible Runtime 2048: Supports 2048 process variables

You can increase the number of process variables with a PowerPack.

1.2.4 Available options

Introduction

Options are available for the following components:

- WinCC flexible Engineering System
- WinCC flexible Runtime on PC-based HMI devices
- Non-PC-based HMI devices

You can operate device-dependent runtime options on the HMI devices.

Each option requires a license.

Options for WinCC flexible Engineering System

Options available for the WinCC flexible Engineering System:

SIMATIC WinCC flexible options	Function	Availability
WinCC flexible /ChangeControl	Version management and modification tracking	WinCC flexible Compact/ Standard/ Advanced

Options for WinCC flexible Runtime

The options depend on the target system used. The following options are available for WinCC flexible Runtime on PC-based HMI devices or for non-PC-based HMI devices:

SIMATIC WinCC flexible RT options	Function	Non-PC-based HMI devices	SIMATIC panel PCs
WinCC flexible /Archives	Archiving functionality in runtime	From Panel 270	x
WinCC flexible /Recipes	Recipe functionality in runtime	Device-dependent available; no licensing necessary.	x
WinCC flexible /Sm@rtAccess	Remote control and remote monitoring as well as communication between different SIMATIC HMI systems.	From Panel 270	x
WinCC flexible /Sm@rtService	Remote maintenance and servicing of machines/plants via the Internet/Intranet.	From Panel 270	x
WinCC flexible / OPC-Server	Use of an HMI device as OPC server	Multi panel	x
WinCC flexible /ProAgent	Process diagnostics during runtime	From Panel 270	x
WinCC flexible /Audit	Reporting interactions according to FDA	From Panel 270	x

Note

The mutual use of the options Sm@rtAccess and Sm@rtService with the option Audit is not enabled.

Note

Installing the Audit Viewer

Audit Viewer is a comfortable tool for evaluating the audit trail of the WinCC flexible / Audit option in preparation of an external analysis on an office PC.

To install Audit Viewer, start the setup.exe on the product DVD in the directory CD_2/Support/Audit Viewer/Setup.

The Audit Viewer can only run on Windows XP.

1.2.5 Licensing

1.2.5.1 Licenses and License Key

Principle

All WinCC flexible editions require a license. Certain WinCC flexible editions require a license to be used without restriction.

- License

You receive your license on paper. The license entitles you to install and use your purchased WinCC flexible edition on a computer. More information about rights of use is available in the electronic catalog CA 01.

- License Key

The license key is delivered on a separate copy-protected USB stick. During setup you are requested to insert the USB stick which contains the License Key.

The data carrier which contains the License Keys is named as storage location in all other documents.

Licenses for the WinCC flexible Engineering System

Which licensing model is going to be used depends on the WinCC flexible edition. The edition is activated by means of the purchased license, that is, the License Key you installed:

- WinCC flexible Micro: License agreement
- WinCC flexible Compact/Standard/Advanced :
 - License agreement and License Key for WinCC flexible Compact on USB stick
 - License agreement and License Key for WinCC flexible Standard on USB stick
 - License agreement and License Key for WinCC flexible Advanced on USB stick

Licenses for WinCC flexible Runtime

WinCC flexible Runtime is licensed using the license agreement and the License Key. WinCC flexible Runtime licenses support a different amount of variables:

- WinCC flexible Runtime 128: Supports 128 process variables
- WinCC flexible Runtime 512: Supports 512 process variables
- WinCC flexible Runtime 2048: Supports 2048 process variables

Licenses for the options packages

You receive a license and a License Key on USB stick for each option. WinCC flexible Engineering System already contains the functionality of the Runtime options package. You do not need a license on your programming computer for configuring the functionality of a runtime option.

1.2.5.2 WinCC flexible without licensing

Principle

Without a license, WinCC flexible runs in demo mode only and the software operability are restricted. Alarms which need acknowledging appear regularly on the screen both in WinCC flexible Engineering System and in WinCC flexible Runtime.

Requesting a new License Key

Contact customer support if the storage location of your License Key was damaged or lost. The storage location of the License Key may be a floppy disk or USB stick.

1.3 Automation concepts

1.3.1 Automation concepts with WinCC flexible

Introduction

WinCC flexible supports the configuration of many different automation concepts. The following automation concepts can be implemented by default using WinCC flexible.

Control with one HMI device

An HMI device which is directly connected to the PLC via the process bus is referred to as a single-user system.

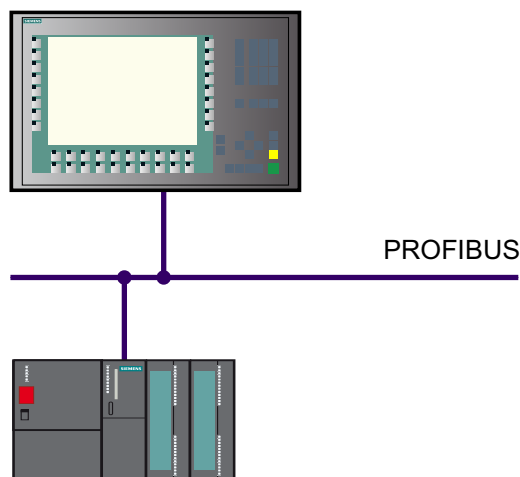

Single-user systems are generally used near production, but can also be deployed to operate and monitor independent part processes or system sections.

PLC with several HMI devices

Several HMI devices are connected to one or more PLCs via a process bus (e.g. PROFIBUS or Ethernet).

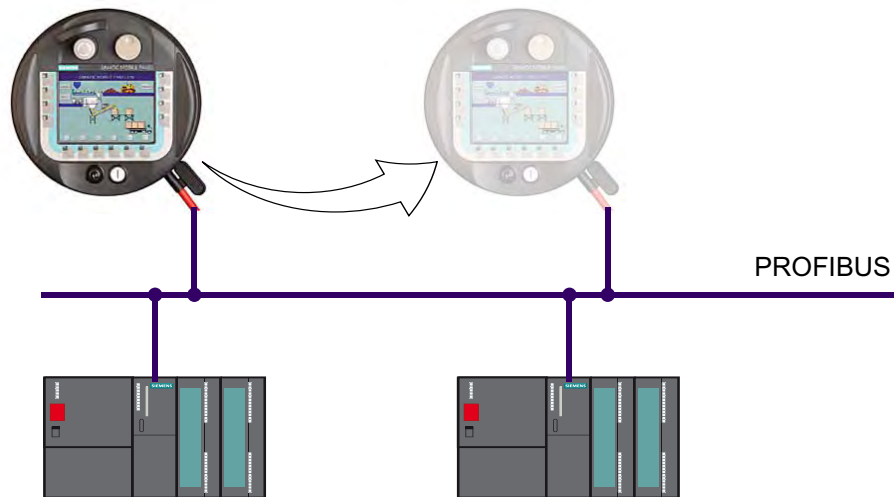

Such systems are deployed, for example, in a production line to operate the plant from several points.

HMI System with centralized functions

An HMI system is connected to a PC via Ethernet. The upstream PC assumes central functions, e.g. recipe management. The necessary recipe data records are provided by the subordinate HMI system.

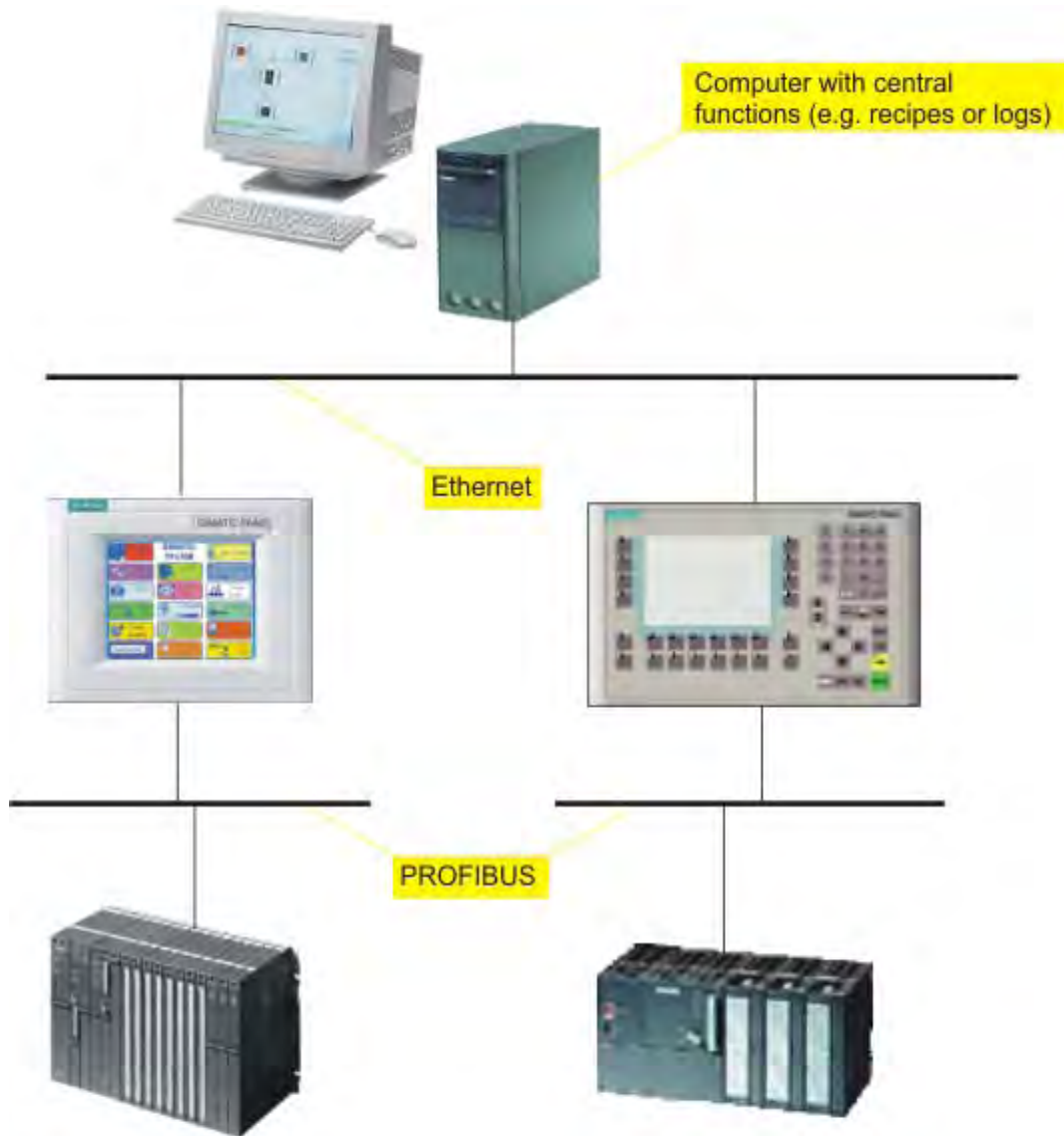

Support for Mobile Units

Mobile units are mainly implemented in large production plants, long production lines or in conveyor technology, but can also be implemented in systems in which direct visual contact with the process is necessary. The machines to be operated are equipped with several interfaces to which the Mobile Panel 170, for example, can be connected.

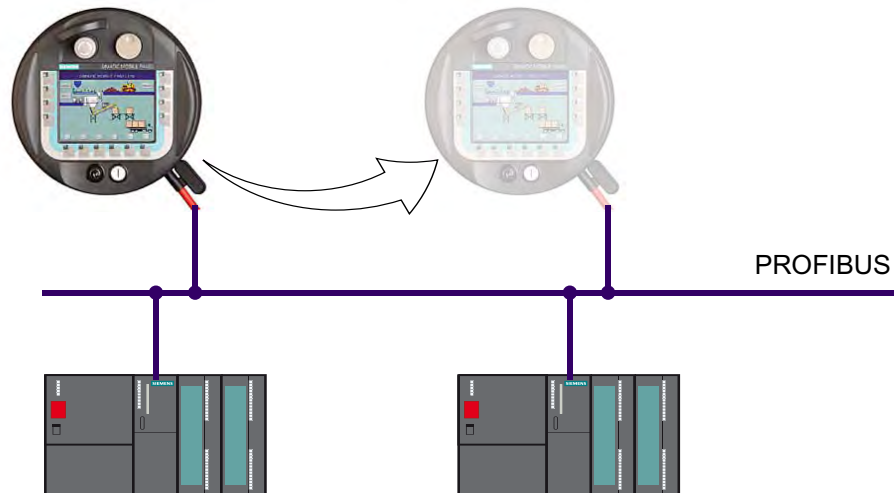

The operator or service technician can thus work directly on site. This enables an accurate setting up and positioning, e.g. during the startup phase. In the case of servicing, mobile units ensure shorter downtimes.

1.3.2 Remote access to HMI devices

Introduction

By using the Sm@rtService option, it is possible to connect to an HMI device from a workstation via a network (Internet, LAN).

Example: A medium-sized production company has a service contract with an external service company. When servicing is required, the service technician responsible can remotely access the HMI device and display its user interface directly on his workstation. In this way, updated projects can be transferred more quickly which, in turn, reduces machine downtime.

Application Possibilities

The option "Sm@rtService" is required for implementation.

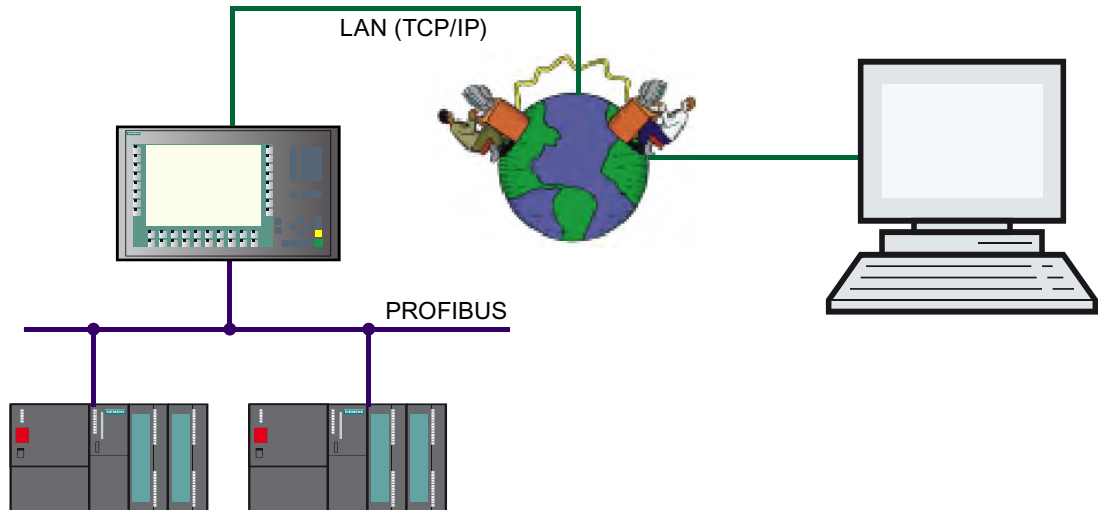

Remote access via a network can be used for the following applications:

- Remote operation and monitoring
An HMI device can be operated and running processes monitored from your own workstation.
- Remote administration
A project can be transferred from a workstation to an HMI device. In this way, projects can be updated from a central point.
- Remote diagnostics
Each Panel provides HTML pages for accessing the installed software, version or system alarms using a Web browser.

1.3.3 Automatic alarm dispatch

Introduction

A machine which fails due to a fault costs money. An alarm that reaches the service technician in a timely manner helps to minimize unplanned downtime.

Example: Contamination in a feed line reduces the flow of coolant. When the value drops below the configured limit value, the HMI device displays a warning. The warning is also dispatched as an e-mail to the service technician responsible.

Principle

The "Sm@rtAccess" option is required for implementation. In order to send alarms as e-mails, the HMI system must have access to an e-mail server.

The e-mail client sends the alarms via intranet or Internet. The automatic alarm dispatch ensures that all the people involved (e.g. shift foreman and sales manager) are informed of the status of the machine in good time.

1.3.4 Distributed HMI

Introduction

Distributed HMI enables the operation of a machine from several synchronized operating stations. All the operating stations display the same process screen. The operating authorization is transferred intelligently.

Principle

The "Sm@rtAccess" option is required for implementation.

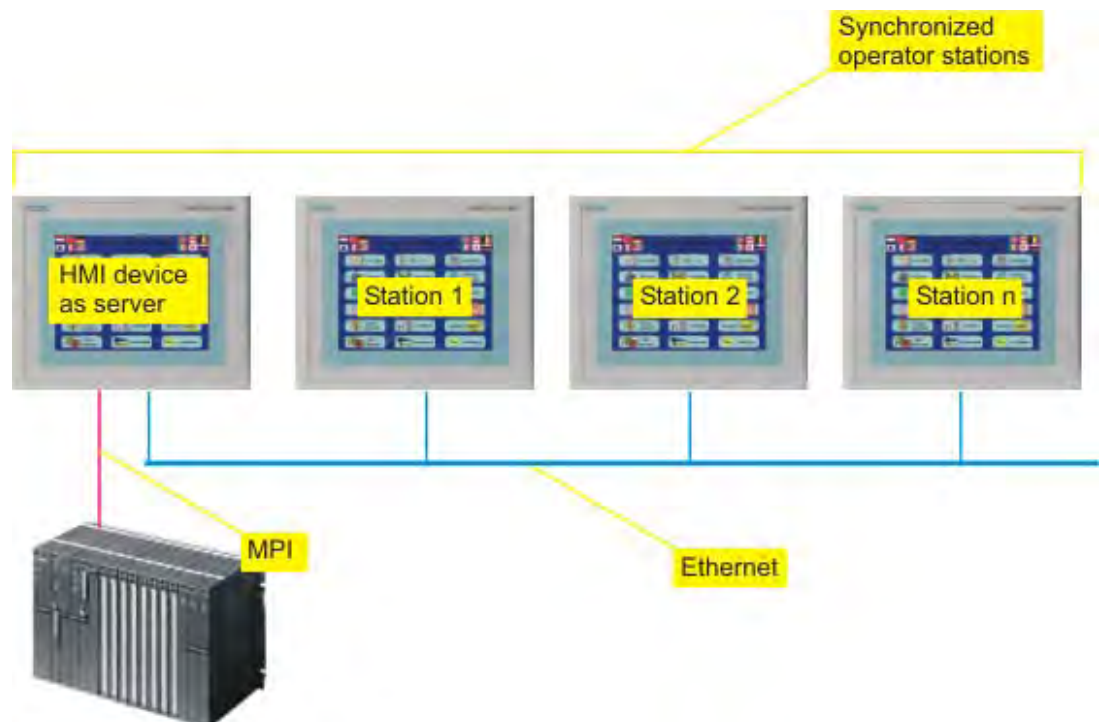

Only one HMI device contains the configuration data and functions as the server. The server can be controlled from the other operator devices. All the HMI devices display the same screens.

1.3.5 Supporting personal HMI devices

Introduction

The support for personal HMI devices enables a machine to be started or serviced independent of a special HMI device.

Example: There are several different machines in a production hall. One technician is responsible for operating and servicing them. The technician is equipped with a personal HMI device (PDA, Personal Digital Assistant) with which he completes the servicing work on the machines.

Principle

The "Sm@rtAccess" option is required for implementation.

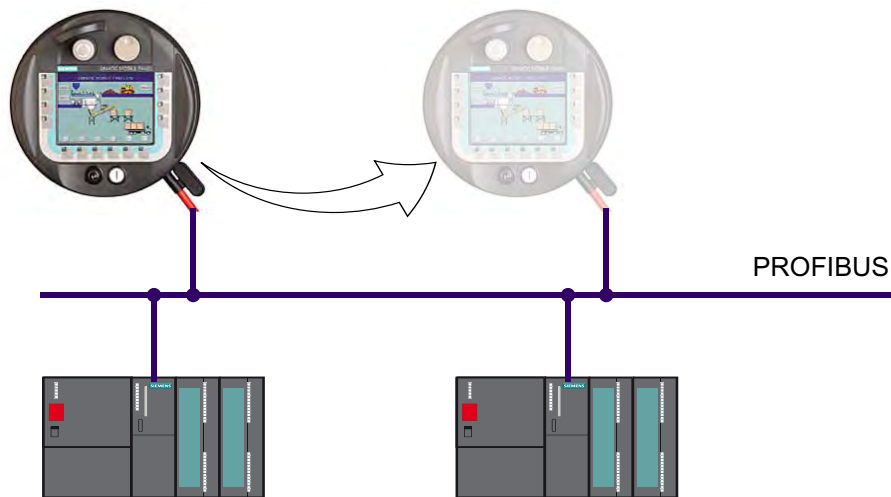

The personal HMI device connects to the server and displays the process screens.

1.3.6 Modular Machine Concepts

Introduction

Approved and tested modules for mechanics, electrics and software were developed for individual machine functions and accelerated the creation of complex machines. Implementation of the modules reduces error frequency and shortens the start up time on site, thus reducing total costs.

Component Based Automation (CBA) based on PROFINet simplifies automation in modular systems and machine construction.

Principle

With WinCC flexible you can create the HMI view of a module and combine it with the control unit to form a complete module. The SIMATIC iMap link editor enables the graphical linking of module interfaces with each other. It is not necessary to program the communication links. Using the link information and the HMI parts of the modules, the basis for visualization with WinCC flexible is automatically generated.

1.4 Configuration concepts

1.4.1 Configuration Support

Introduction

WinCC flexible is used to configure user interfaces to operate and monitor machines and plants. WinCC flexible provides support for the configuration tasks in the form of solution-oriented concepts. For example, this could concern the processing of bulk data, automatic transfers or even the intelligent configuration of movement paths.

Engineering support

Efficient configuration saves time and costs. WinCC flexible supports the following for this:

- Target system dependent configuration
During configuration, only those functions supported by the selected target system are displayed.
- Engineering independent of the PLC used
If you use a project for different or several target systems, you only switch over the HMI device in the project. Functionalities of the selected HMI device which are not supported are not displayed.
- Central modification of referenced objects
Modifications made at a central station are applied to the entire project.
- Use
The reuse of configuration objects simplifies configuration and reduces overall costs.
- Bulk data processing
Create an action, for example, with several tags having the same values or chronologically ascending addresses.
- Graphic Configuration of the Screen Navigation
Create a screen hierarchy from the graphic overview of the configured screens. The required objects for the screen navigation are generated automatically.
- Configuring movement paths
Configure the movement of objects clearly in the process screen.
- Totally Integrated Automation
Benefit from the smooth integration of WinCC flexible in the configuration user interface of SIMATIC STEP 7 and SIMOTION SCOUT.

User customization of the programming user interface

The WinCC flexible Workbench can be user customized by moving or hiding windows and toolbars.

1.4.2 Scalable Configuration Tools

Introduction

If WinCC flexible is used to edit projects for different HMI devices, the functional scope is adapted to the HMI device during configuration. Different functionality is available according to the HMI device.

Custom HMI Device Functions

Custom device functions ensure efficient configuration. You only need to configure those functions which are supported by the specific HMI device.

The editors displayed in the Project View can be used, for example, to quickly detect which functions are supported by the HMI device selected.

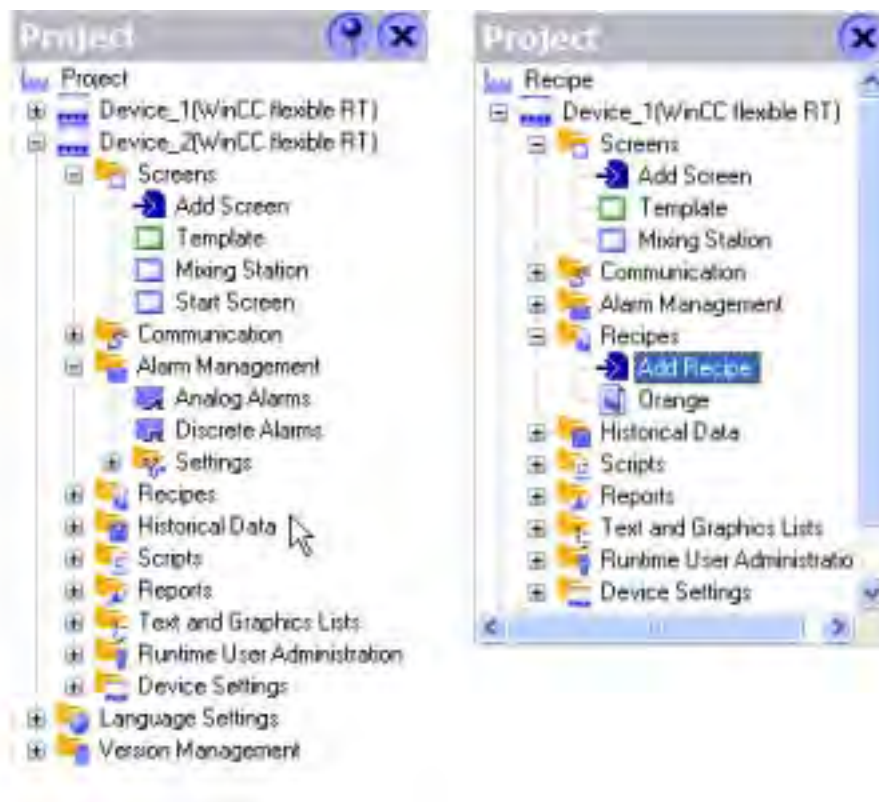

You can use a project for different target systems. If the target system is changed, only the view of the project data is modified. When the target system changes, configured objects are not deleted; they are only hidden if some features are not supported by the target system.

Customized setup of the configuration user interface

WinCC flexible allows you to customize the position and reaction of windows and toolbars. This allows you to configure the work environment to meet your special requirements.

The configuration of the WinCC flexible workbench is linked to the user logged on in Microsoft Windows. On saving the project, the positions and behavior of windows and toolbars are automatically saved with it.

When opened again, the positions and behavior of windows and toolbars are identical to when the project was last saved. When the working environment opens, it is identical to the configuration when last closed. This is also the case when a project edited by a different project planner is opened.

1.4.3 PLC-independent configuration

Introduction

WinCC flexible supports you in creating configurations independent on the destination system.

Example: A machine has three operating stations. One HMI device with average performance connected to one of these operating stations is sufficient.

Principle

The project need not be recreated for this HMI device. Simply switch the HMI device in the project instead.

Functions not supported by the HMI device are hidden.

The different HMI devices should not differ too much in their resolution and functionality.

1.4.4 Use

Introduction

Reusing configuration objects facilitates configuration work. Centralized editing saves a considerable portion of the configuration work when an object is changed.

Faceplates

Simple screen objects can be combined as faceplates to form complex objects. For each faceplate, it is possible to define which properties of the screen objects can be changed. By reusing a faceplate stored in the library, modifications can be executed throughout the entire project from a central point.

Libraries

All configuration objects can be stored centrally in libraries. In addition, numerous preconfigured screen objects are supplied which can be used to design process screens appropriately.

Text Libraries

Text libraries can be used to store all configuration texts in several languages. If a project is configured in several languages, the texts can be translated automatically.

1.4.5 Intelligent tools

1.4.5.1 Bulk data processing

Introduction

Bulk data management provides support in the simultaneous creation and editing of several objects. Configuration is more efficient, saving time and costs.

Example: A part of the tag inventory is assumed from an old project but the inventory has the wrong tag type. Using WinCC flexible, the tag type can be modified for all tags in one working step.

Principle

The advantages of bulk data processing can be used when creating and editing specific objects (e.g. tags).

- Automatic address assignment

If several tags, created with process linking, are stored successively in the controller memory, the address area can be increased automatically for each tag.

- Multiple modification

Identical modifications for several tags can be executed in one step, e.g. changing the tag type or the controller.

1.4.5.2 Configuring movement paths

Introduction

Process sequences involving object movement can be clearly displayed on the HMI device, e.g. the transport of a product on a conveyor belt.

Movement paths simplify the configuration of movements of objects in the process screen. The movement process is represented on the screen by a diagram.

Principle

The movement path for an object is defined in the process screen. The movement path is composed of the starting point and finishing point. The movement path is assigned a tag. The tag value defines the relative position of the object on the movement path in runtime.

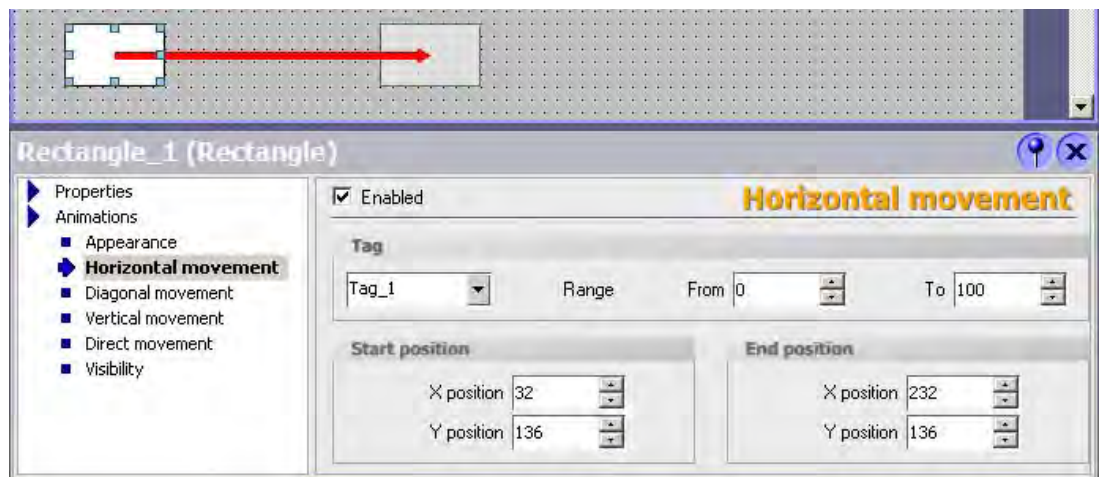

1.4.5.3 Graphic Configuration of the Screen Navigation

Introduction

Screen navigation means configured hierarchy for process screens. Using the screen navigation, a fixed navigation structure is defined for a project. Operators can use the navigation control in runtime to navigate between the various screens of the structure.

Principle

Use the Screen Navigation editor to place screens in the required location in the screen hierarchy using drag-and-drop. You can also create a direct link between screens that are not integrated in the hierarchy. The navigation buttons can be pasted in the process screen.

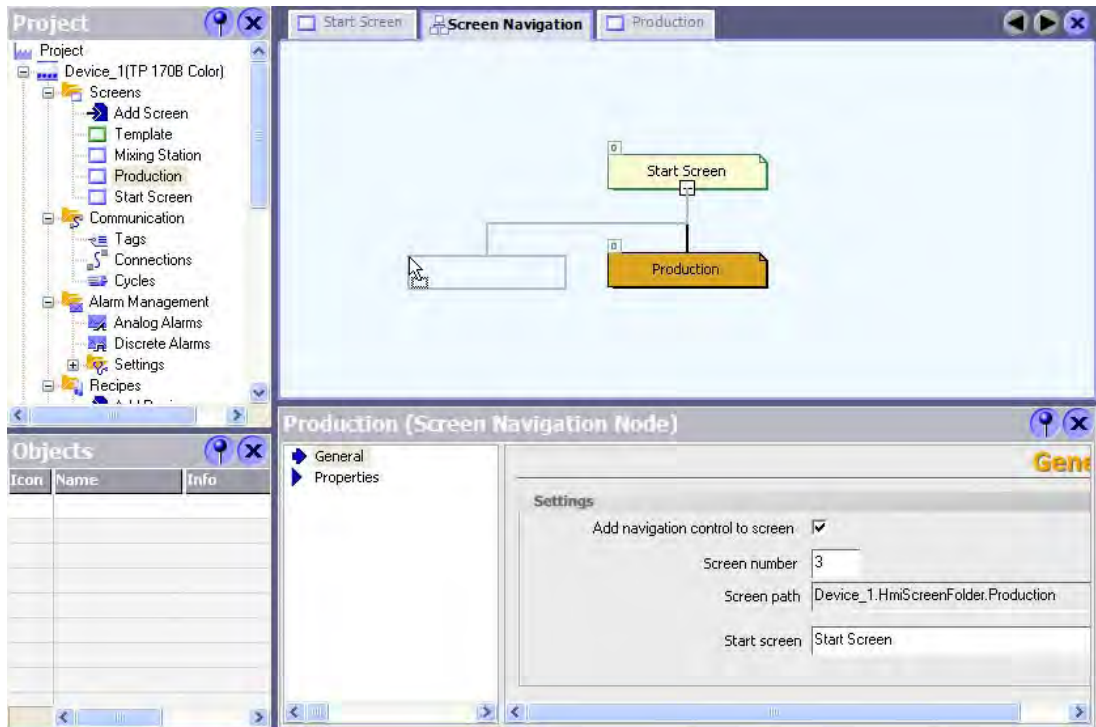

The creation of a navigation structure offers the following advantages:

- Overview of the navigation structure throughout the entire project.
- Quick creation of direct links between process screens.
- Automatic creation of the basic screen navigation.

1.4.6 Totally Integrated Automation

Introduction

A full automation solution not only involves an HMI system such as WinCC flexible but additional components, e.g. PLC, process bus and periphery.

A particularly sophisticated integration is provided by WinCC flexible with components from the SIMATIC product range and the SIMOTION product range.

- Consistent configuration and programming
- Consistent data retention
- Consistent communication

Integration in SIMATIC STEP 7

Process tags provide the link for communication between the PLC and HMI system. Without the advantage of the Totally Integrated Automation, each tag would have to be defined twice: once for the PLC and once for the HMI system.

The integration of SIMATIC STEP 7 in the configuration user interface leads to a lower error frequency and reduced configuration work. During the configuration, direct access is made to the STEP7 icon table and the communication settings.

- The STEP 7 symbol table contains database definitions (e.g. addresses and data types) defined during the creation of the control program.
- The communication settings contain the bus addresses and PLC protocols. The communication settings are made in NetPro.

Integration in SIMOTION SCOUT

The integration of SIMOTION SCOUT in WinCC flexible not only provides the advantages of the integration of SIMATIC STEP 7 but also the full integration in the SIMOTION-SCOUT user interface.

WinCC flexible Engineering System

2.1 Basic Principles on the Programming Interface

Principle

WinCC flexible is the HMI software for future-proof machine-oriented automation concepts with comfortable and highly efficient engineering.

You can access all functions supported by the selected HMI device. To start WinCC flexible, either click the desktop icon on the programming device or select it from the Windows Start menu.

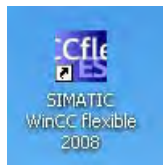

WinCC flexible only allows one project to be open at any time. You can work simultaneously on several projects by opening WinCC flexible as many times as necessary.

Note

WinCC flexible also allows you to configure several HMI devices in the same project.

2.2 WinCC flexible user interface

2.2.1 WinCC flexible User Interface Elements

Introduction

The WinCC flexible work environment consists of several elements. Some of the elements are linked to specific editors which means they are not visible unless the corresponding editor is active.

Note

The layout of the dialog boxes depends on the display settings in the Control Panel. The texts are truncated depending on the setting

Set up the operating system of your configuration PC to "Standard size (96 dpi)". The settings are available in the Control Panel, at "Display -> Settings -> Advanced > General -> DPI Setting".

Elements of WinCC flexible

WinCC flexible consists of the following elements:

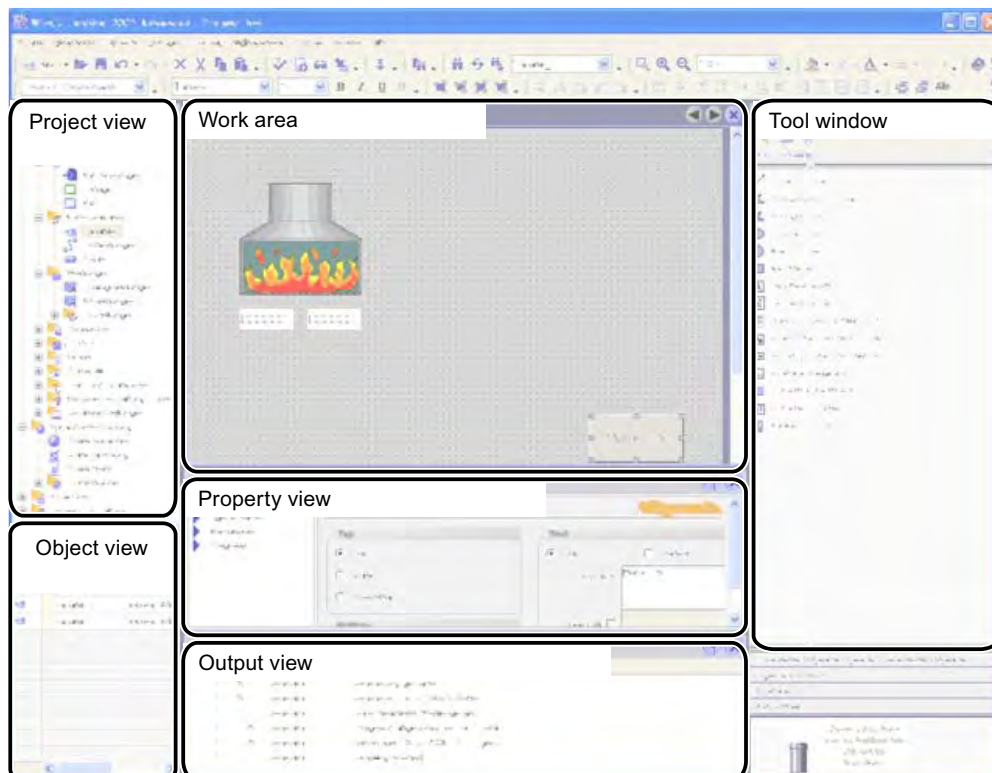

Menus and Toolbars

You can access all the functions provided by WinCC flexible by means of its menus and toolbars. When the mouse pointer is moved over a function, a ToolTip appears.

Work area

Project objects are edited in the work area. All WinCC flexible elements are arranged on the borders of the work area. With the exception of the work area, you can organize, configure and, for example, move or hide any of the elements to suit your individual requirements.

Project View

All component parts and editors available in a project appear in a tree structure in the Project View. Folders are provided as sub-elements of each editor in which you can save objects in a structured way. In addition, direct access to the configured objects is available for screens, recipes, scripts, protocols and user dictionaries. In the project windows you have access to the device settings of the HMI device, the language settings and the version management.

Property view

The Property View is used to edit object properties, e.g. the color of screen objects. The property view is only available in specific editors.

Toolbox

The toolbox contains a selection of objects which you can add to your screens, e.g. image objects or operator control elements. In addition, the toolbox also provides libraries containing object templates and collections of faceplates.

Library

The "Library" is an element of the Toolbox view. The "Library" provides access to screen object templates. You can always add screen objects and thus increase programming efficiency either by multiple use or reuse of object templates. The library is your central database for storing frequently used objects, such as screen objects and tags.

Output View

The output window displays system alarms generated, for example, in a project test run.

Object view

The "Object View" shows all elements of the area selected from the "Project View".

Note

With the exception of the work area, you can show or hide all windows in the "View" menu.

2.2.2 Menus and Toolbars

Introduction

The menus and toolbars provide access to all functions you need to configure your HMI device. When the corresponding editor is activated, menu commands and toolbars specific to that editor appear.

When the mouse pointer is moved over a command, the corresponding ToolTip appears.



Positioning the Toolbars

Menus and toolbars are, as a standard, positioned at the top edge of the screen when creating a new project. The position of menus and toolbars is determined by the user who is logged on in Windows. If the toolbars are moved using the mouse, they revert back to their last 'Exit' position when WinCC flexible is restarted.

Menus

Menus available in WinCC flexible:

Menu	Short description
"Project"	Contains commands for project management.
"Edit"	Contains commands for clipboard and search functions.
"View"	Contains commands for opening / closing elements, and for zoom / layer settings. To reopen a closed element, select the "View" menu.
"Paste"	Contains commands for pasting new objects
"Format"	Contains commands for organizing and formatting screen objects.
"Faceplates"	Contains commands for creating and editing faceplates.
"Tools"	Contains commands for changing the user interface language and configuring the basic settings in WinCC flexible, for example.
"Script"	Contains commands for the synchronization and syntax check of scripts.
"Window"	Contains commands for managing multiple windows in the work area, e.g. for changing to other windows.
"Help"	Contains commands for calling help functions.

The availability of the menus and the scope of their commands depend on the respective editor which is used.

Toolbars

The toolbars provide quick access to important, frequently used functions. The following toolbar configuration options are available:

- Adding and removing buttons
- Changing the position

2.2.3 Work area

Introduction

The work area is used to edit project data either in table format, e.g. the tags, or in graphic format, e.g. a process screen.

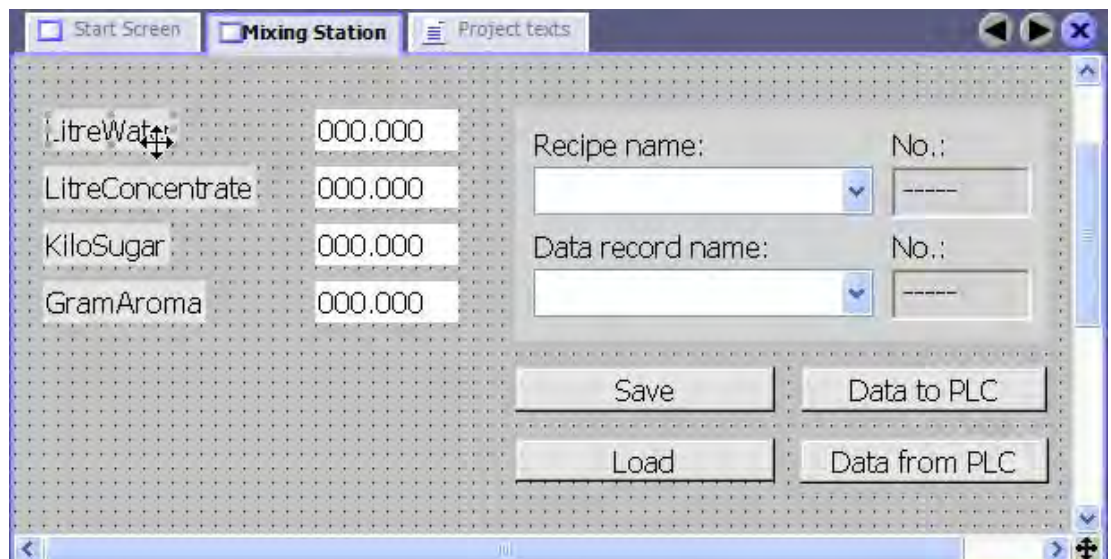

Description

Each editor is opened in a separate tab control on the work area. In the case of graphic editors, each element is displayed on a separate tab control. Only one tab is active when several editors are open simultaneously. To move to another editor, click the corresponding tab. You can open up to 20 editors in parallel.

2.2.4 Project View

Introduction

The project view is the central control point for project editing. All component parts and editors available in a project appear in a tree structure in the Project View. Each editor is assigned a symbol which you can use to identify the corresponding objects. Only those elements which are supported by the selected HMI device are displayed in the project window. In the project windows you have access to the device settings of the HMI device, the language settings and the version management.

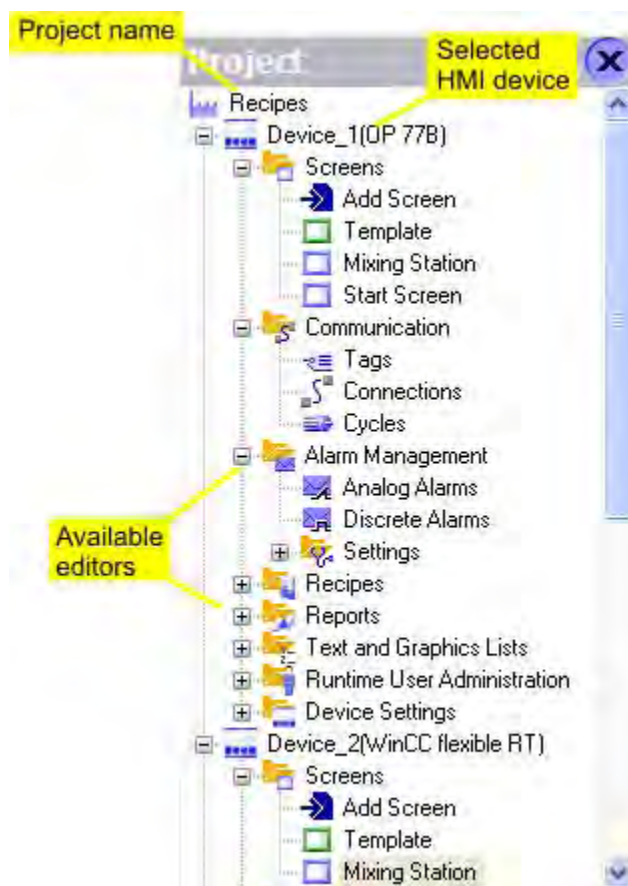

Description

The Project View displays the project structure hierarchically:

- project
- HMI devices
- Folder
- Objects

The project view is used to create and open objects for editing. You can organize your project objects in folders to create a structure. Handling the Project View is similar to handling Windows Explorer. Shortcut menus, which consist of the most important commands, are available for all objects.

Elements of graphic editors are displayed in the Project View and Object View. Elements of "tabular editors" are shown only in the Object View.

2.2.5 Property view

Introduction

The Property View is used to edit the properties of an object selected from the work area. The content of the property view is based on the selected object.



Description

The "Property View" shows the properties of the selected object organized in categories. The changed values take effect directly after exiting from the input field.

Invalid entries are highlighted with a colored background. A ToolTip will appear to help you correct the entry.

Example

The object property "height" is logically linked to a "Byte" variable. This tag type has a range of values from 0 to 255. When you enter a value of "300" in the "Height" input box of the "Property View", the value is highlighted with a colored background when you exit the box.

2.2.6 Library

Introduction

The "Library" is an element of the Toolbox view. The library is your central database for storing frequently required objects. You need to configure the object stored in the library once only. You can then reuse it as many times as you like. You can always add screen objects and thus increase programming efficiency either by multiple use or reuse of object templates.

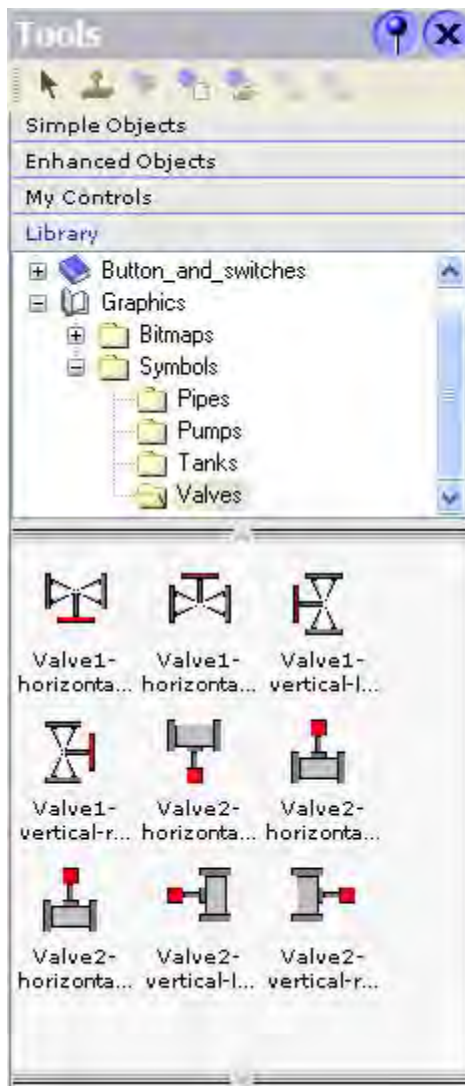

Description

WinCC flexible distinguishes between global and project libraries:

- Shared library

The global library is not saved in the project database. It is written to a file. The file is saved by default in the installation directory of WinCC flexible. The global library is available for all projects.

- Project library

The project library is stored with the project data in the database and is available only in the project for which it was created.

You can create folders in both libraries to generate a structure for the objects they contain. Furthermore, you can always copy elements from a project library to the global library.

Opening the library in a separate window

You can swap the library from the "Toolbox View" to a separate window. To do so, select the "Library in Toolbox" command from the shortcut menu of the Library view. Select this command again to restore the library to the "Toolbox View".

2.2.7 Output View

Introduction

The output window displays system alarms generated, for example, in a project test run.

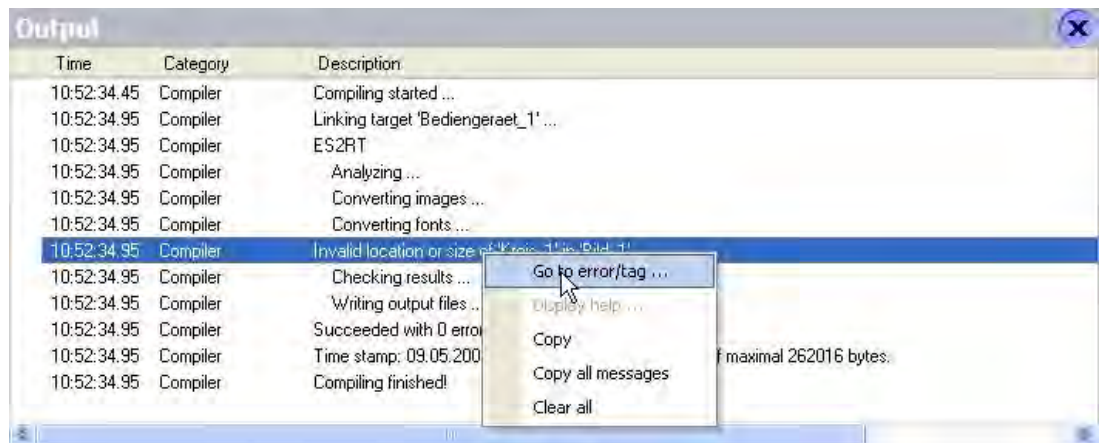

Description

The output view normally displays system alarms in the order they occur. The categories define the corresponding WinCC flexible module which has generated a system alarm. For example, system alarms for the "Generator" category are generated during the consistency check.

To sort system alarms, click the header of the corresponding column. The pop-up menu can be used to jump to an error location or a tag, and copy or delete system alarms.

The output view shows all system alarms of the last action. A new action overwrites all previous system alarms. You can still retrieve old system alarms from a separate log file.

2.2.8 Object view

Introduction

If folders or editors are selected in the Project View, their content is displayed in the Object View.

The following figure illustrates how the selection in the Project View affects the display in the Object View:



Description

Double-click an object in the OBJECT View to open the corresponding editor. Drag-and-drop functions are available for all objects displayed in the object window.

The following drag-and-drop actions, for example, are supported:

- Moving a tag to a process screen in the work area: Creates an I/O field which is linked to the tags.
- Moving a tag to an existing I/O field: Creates a logical link between the tag and the I/O field.
- Moving a process screen to another process screen in the work area: Generates a button with screen change function which is linked to the process screen.

Long object names are abbreviated in the "Object View". After moving the mouse pointer to the object, the full name appears as a ToolTip.

When a large number of objects are available, quickly locate the object you require by entering just the first letter of the object.

2.3 Placing editor-specific operating elements

Introduction

Editor-specific operating elements are only visible in the active work area of the corresponding editor.

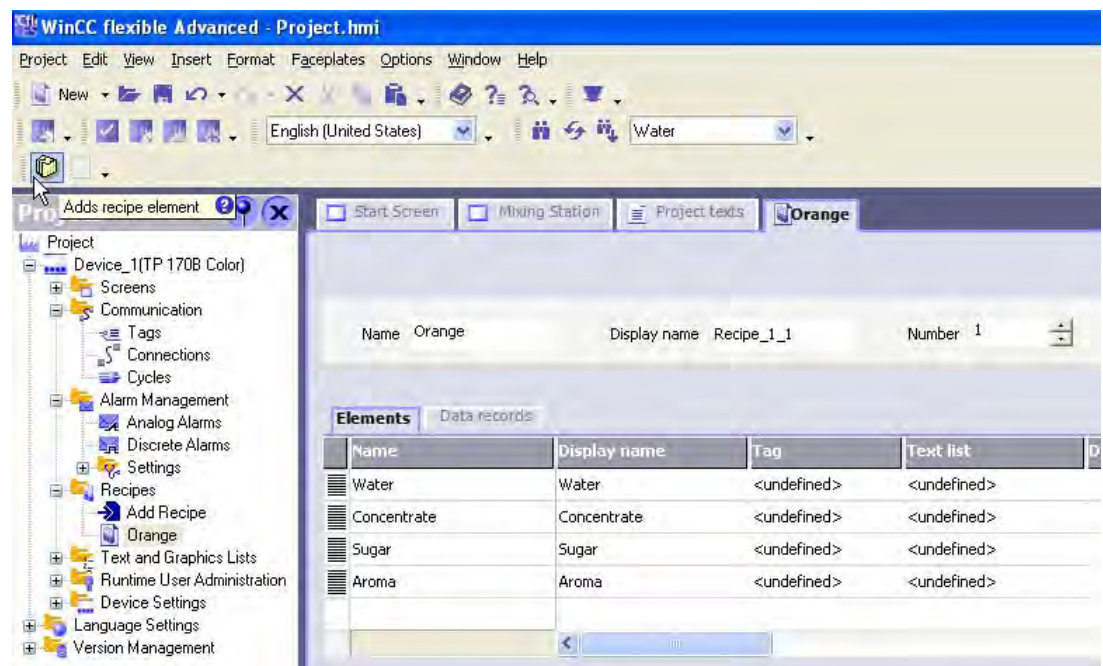

Editor-specific operating elements include:

- Toolbars
- Toolbox
- Menu commands

Placement

The default position of editor-specific toolbars is on the right-hand side or below the existing toolbars.

Default position of editor-specific toolbox views is the screen margin on the right-hand side.

Editor-specific commands are added to the corresponding menus.

The positions of editor-specific operating elements are restored the next time you start WinCC flexible if you have rearranged these in a previous session to suit your individual requirements.

2.4 Working with windows and toolbars





Introduction

WinCC flexible allows you to customize the layout of frames and toolbars. You can hide certain frames which are not used frequently in order to enlarge the work area.

The "View" menu can be used to restore the default layout of frames and toolbars.

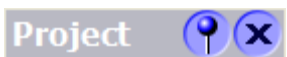
Operating Elements Available

The table below shows you the operating elements of the frames and toolbars and what they are used for.

Operator control element	Purpose	Where used
	Closes a frame or toolbar	Frames and toolbars (movable)
	Moves and docks frames and toolbars using drag-and-drop	Frames and toolbars (movable)
	Moves a toolbar by means of drag-and-drop	Toolbar (docked)
	Adds or deletes toolbar icons	Toolbar (docked)
	Activates the auto-hide mode for a window	Frame (docked)
	Disables auto-hide mode for a frame	Frame (docked)

Docking frames or toolbars

"Docking" refers to the integration of a window into the WinCC flexible workbench. You can automatically hide docked frames in order to increase your workspace.

A freely moveable window can be docked on a window at the following positions:

- Upper edge
- Right edge
- Bottom edge
- Left edge

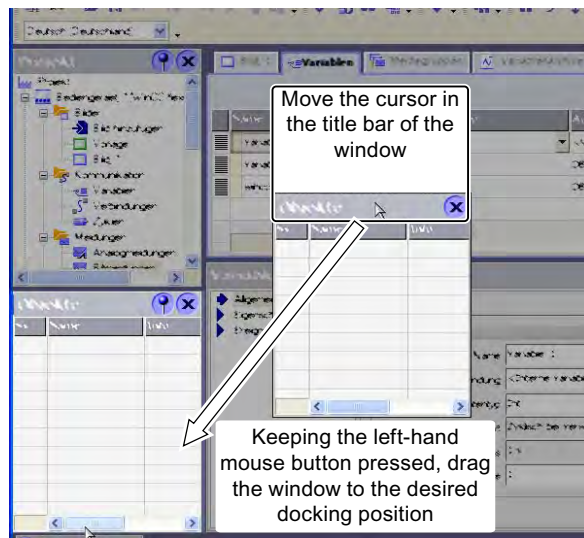

You can dock a toolbar onto any existing toolbar.

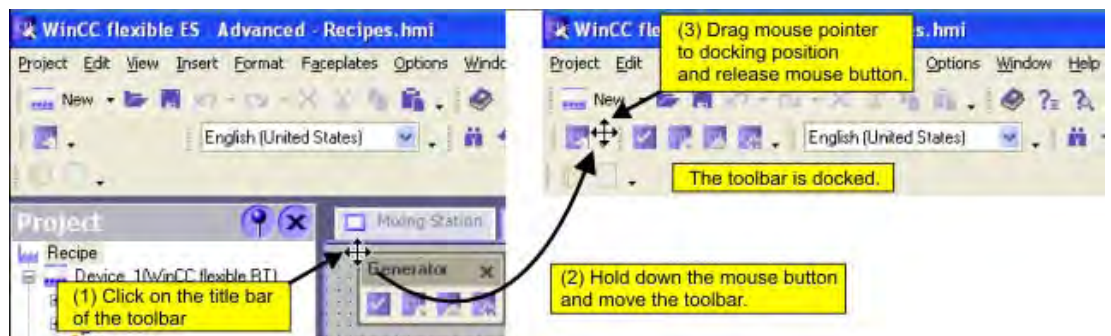

Combined frames

You can combine a frame with another frame. Each frame is represented in the combined frame by a separate tab. To change to a different frame, click the corresponding tab.

Hiding windows automatically

You can automatically hide the windows you do not require frequently. This will increase your work area. To restore the window to the screen, click its title bar.

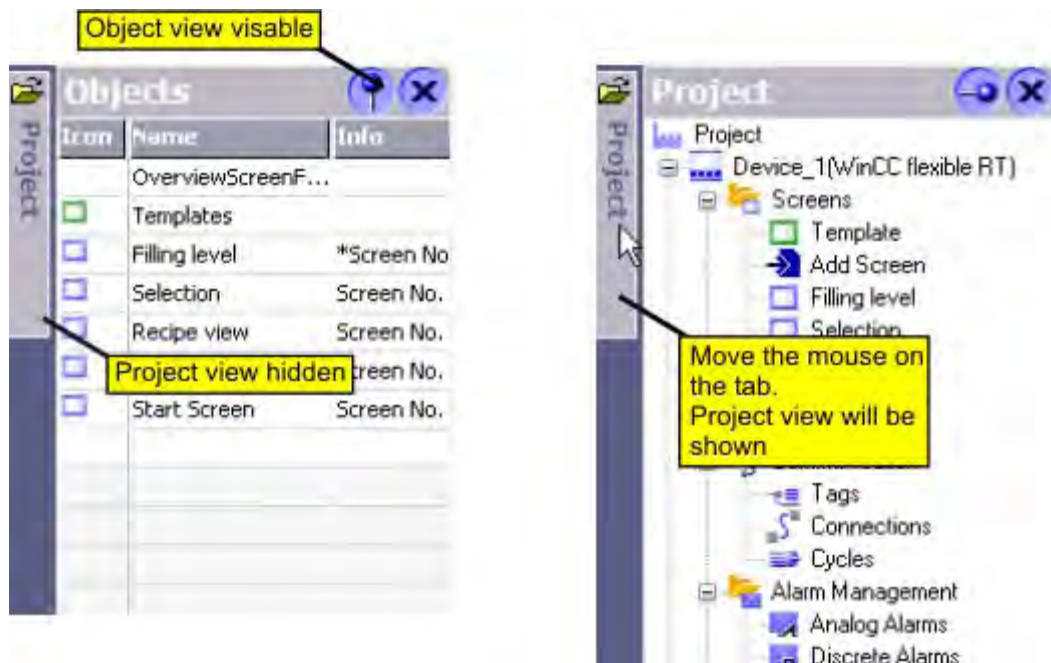

2.5 Working with the Mouse



Introduction

Work is mainly completed with the mouse in WinCC flexible. Important operating functions in this context are the drag-and-drop function and the call of commands from the shortcut menu.

Drag-and-drop

Drag-and-drop makes configuration much easier. For example, when you drag-and-drop a variable from the Object View to a process screen, the system automatically generates an I/O field which is logically linked to the tag. To configure a screen change, drag-and-drop the required process screen onto the process screen shown in the work area. This generates a button configured to contain a corresponding screen change function.

The drag-and-drop function is available for all objects in the project view and "Object view." The mouse pointer shows you whether drag-and-drop is supported at the destination or not:

-  Drag-and-drop is possible
-  Drag-and-drop is not possible

Shortcut menu

In WinCC flexible, you can right-click any object to open a shortcut menu. The shortcut menu contains the commands you can execute in the relevant situation.

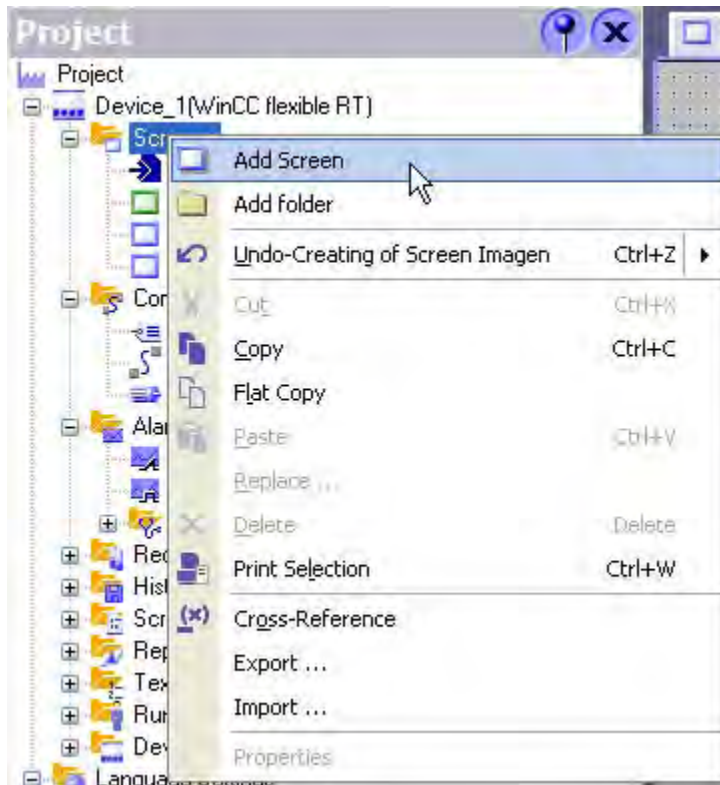

Overview: Mouse functions

Function	Effect
Left-click	Activates any object or executes an action such as a menu command or drag-and-drop.
Right-click	Opens a shortcut menu.
Double-click (left mouse button)	Starts an editor in the Project View or Object View or opens a folder.
<Left mouse button+drag-and-drop>	Generates a copy of the object in the project view.
<CTRL+left mouse button>	Selects a number of individual objects from the "Object view" one after the other.
<SHIFT+left mouse button>	Selects all objects within the rectangle lasso you have drawn with the mouse in the "Object view."

2.6 Keyboard control

Introduction

WinCC flexible provides a number of hotkeys which you can use to execute frequently required menu commands. The menu shows whether a hotkey is available for the relevant command or not.

WinCC flexible also integrates all the standard hotkeys provided by Windows.

Important hotkeys

The table shows you the most important hotkeys for use in WinCC flexible.

Hotkeys	Effect
<Ctrl+Tab>/<Ctrl+Shift+Tab>	Activates the next/previous tab in the work area.
<Ctrl+F4>	Closes the active view in the work area.
<Ctrl+C>	Copies a selected object to the clipboard.
<Ctrl+X>	Cuts an object and copies it to the clipboard.
<Ctrl+V>	Inserts the object stored in the clipboard.
<Ctrl+F>	Opens the "Find and Replace" dialog.
<Ctrl+A>	Selects all objects in the active area.
<ESC>	Cancel an action.

2.7 Working with WinCC flexible

2.7.1 Working with WinCC flexible

Introduction

WinCC flexible offers a range of scalable engineering systems which are optimally adapted to the respective configuration task or can be adapted by the user. Each edition supports a wider range of HMI devices and functions, whereby the "Standard" edition can be used to configure HMI devices from the "Micro" edition. You can always migrate to a higher edition by means of a powerpack.

Functional scope of the individual editions

WinCC flexible is available in the following editions:

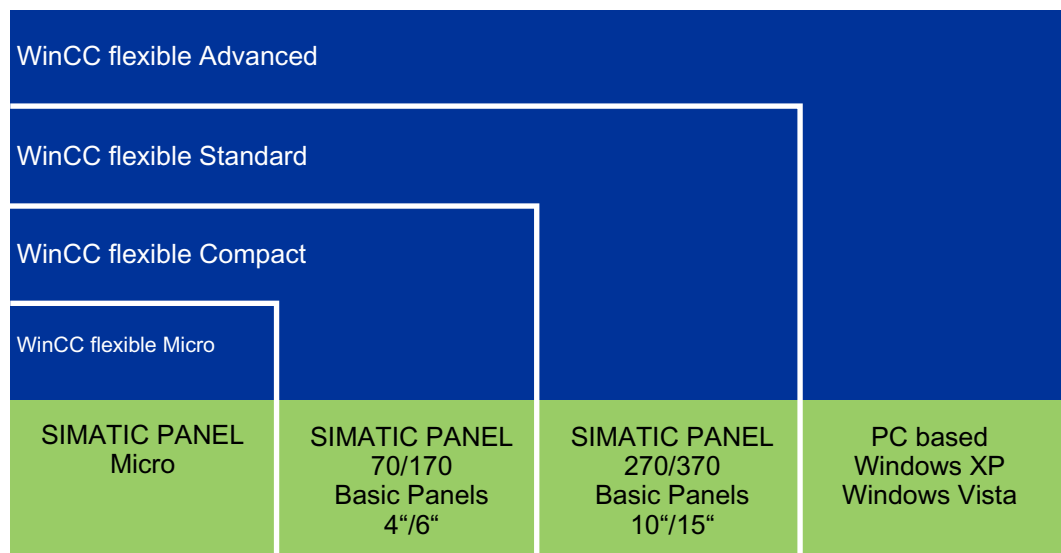

2.7.2 Working with projects

Introduction

WinCC flexible is used to configure user interfaces to operate and monitor machines and plants.

Special editors are available for the different configuration tasks. All configuration information is saved in a project.

Creating or Loading a Project

After starting WinCC flexible, a wizard guides the user through all the steps which are necessary to create a new project. The user is prompted, for example, to enter a name for the project and select an HMI device.

If WinCC flexible is already open, select the "New" command to create a new project. In some circumstances, a wizard will appear to guide you through the process.

To load an existing project, select the "Open" command from the "Project" menu.

Device-based dependency

WinCC flexible only provides the functionality supported by the HMI devices selected. The Project View displays the editors available for configuration.

Migration

If an existing ProTool or WinCC project is opened in WinCC flexible, the data is converted. The user is guided through the conversion process and informed of the progress of the conversion.

2.7.3 Editing Multiple Projects with WinCC flexible

Principle

WinCC flexible only allows one project to be open for editing at any time. If projects should be copied globally, for example, restart WinCC flexible and then open the required project.

Note

If both ProTool and WinCC flexible are installed on your PC, you can only open one of the programs at a time.

Several HMI devices can be set up parallel in each project.

Each opened WinCC flexible is shown in the Windows task bar:



2.7.4 Functional scope of a project

Introduction

If WinCC flexible is used to edit projects for different HMI devices, the functional scope is not identical for the configuration. Different functionality is available according to the HMI device.

Principle

The functional scope available is dependent on the HMI device selected. Only configure the functions supported by the selected HMI device. This procedure is advantageous for efficient configuration.

The editors displayed in the Project View can be used, for example, to quickly detect which functions are supported by the HMI device selected.

The diagram illustrates the functional scope of two different HMI devices based on the Project View:



2.7.5 Editor Properties

Introduction

WinCC flexible provides a special editor for each configuring task. WinCC flexible differentiates between two different types of editors: graphical editors and tabular editors. You can open up to 20 editors in parallel.

Graphical Editors

Graphical editors, such as the Screen editor, display the elements belonging to both the Project View and Object View. You open each object in the work area with graphical editors.

Tabular editors

Tabular editors, such as the Tag editor, only display the associated objects in the Object View. When a tabular editor is opened to edit the objects, all associated objects are displayed in a table in the work area

Editor properties

The following properties apply to all editors and their objects:

- Changing contents

Changes take effect directly after exiting an input field and affect projects globally. All the objects affected by a modification are automatically updated.

If a tag parameter is changed at the place of use in the Screens Editor, for example, the change has a direct effect in the Tag editor.

- Accepting changes to the project data

The modified project data are transferred to the project database as soon as the project is saved.

- Undo or redo working steps

Every editor has an internal list in which user actions are saved. In this way, all actions can be reverted (undone) or restored. The relevant commands are in the "Edit" menu. The list is deleted when the editor is closed or the project is saved. Switching to another editor does not affect the actions stored in the list.

Note

If you notice that the editor is having trouble loading screens, the cause may be that the graphics driver is not up-to-date.

2.7.6 Open Editor

Introduction

The way in which an editor is started depends on whether it is a graphical editor (e.g. Screen Editor) or tabular editor (e.g. Tag Editor). You can open up to 20 editors in parallel.

Opening a Graphical Editor

A graphical editor is started by either creating a new object or opening an existing object.

To create a new object, proceed as follows:

1. Click the right mouse button on the graphical editor in the Project View in which a new object is to be added.
2. Select "Add screen" in the shortcut menu, for example.

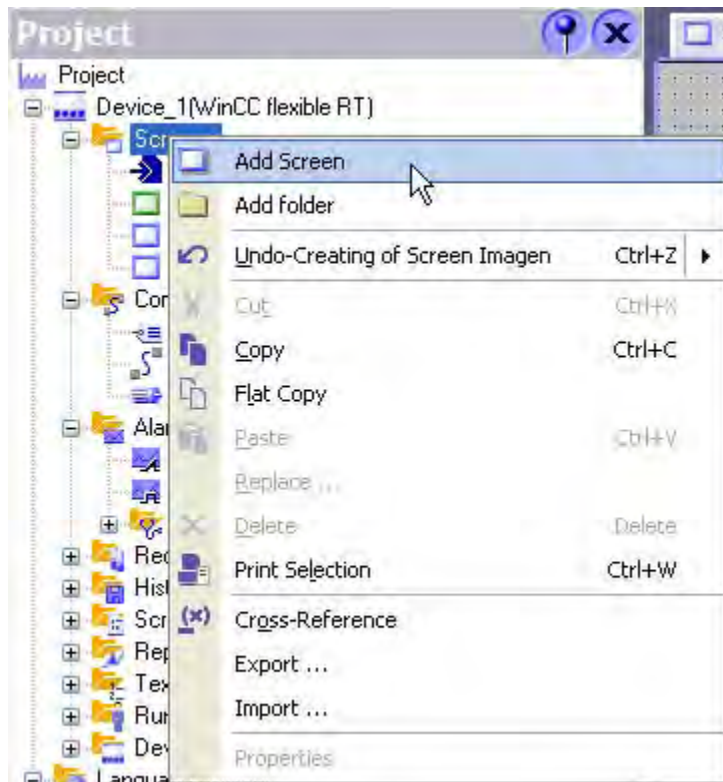

The object, e.g. a screen, is created in the Project View and displayed in the work area.

3. To open an existing object, double-click on the object in the Project View or Object View.
The object, e.g. a screen, is displayed in the work area.

Opening a tabular editor

A tabular editor is opened by double-clicking on the tabular editor in the Project View. The editor appears in the work area.

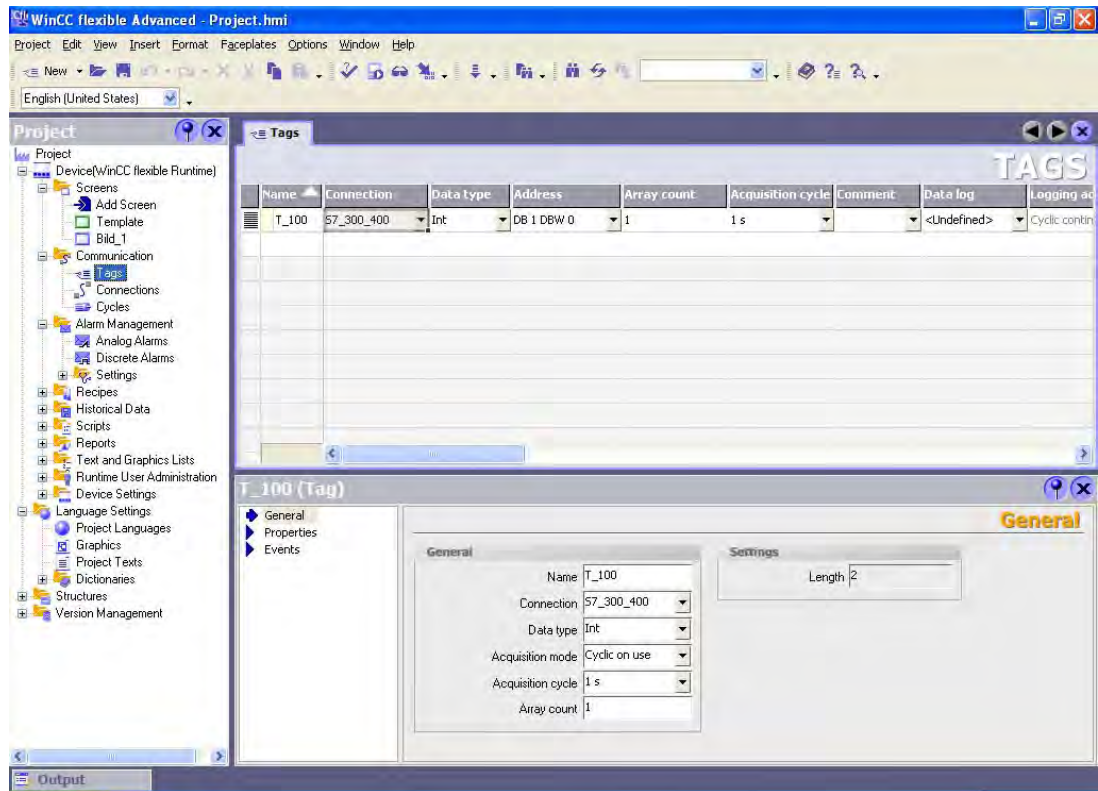

A tabular editor can also be activated using the associated shortcut menu. To open an existing element in the tabular editor, select the tabular editor in the Project View. Then double-click on the required object in the Object View.

Alternative procedure

To open an editor via the menu, select the "New object in project" command from the "Insert" menu.

2.7.7 Switching between editors

Introduction

Although several editors or their objects can be opened simultaneously in WinCC flexible, only the work area of one editor can be active in the work area.

If several editors are open, they are represented by separate tab controls in the work area.

Tab Controls

To select a different editor, click the relevant tab in the work area. In tabular editors, a tab shows the name of the editor for easy identification. In the case of graphical editors, the name of the current element is indicated, e.g. "Screen1".

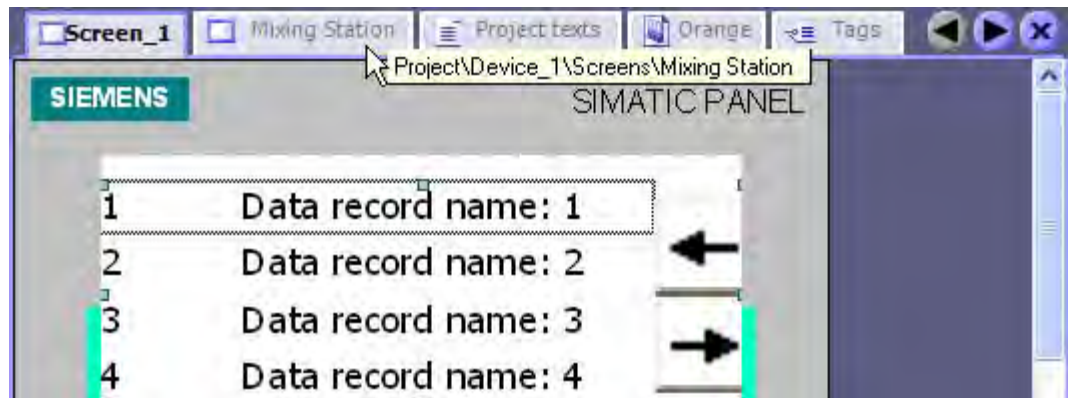

The tooltip indicates which HMI device is being configured in the editor.

Navigation arrows

If the work area runs out of space to show all tabs, the navigation arrows become active in the work area.

To access tabs which are no longer visible in the work area, click the corresponding navigation arrow.



Closing the editor

To close an editor, click the  symbol in the work area.

2.7.8 Object List

Introduction

The object list is a helpful feature for configuration tasks in WinCC flexible. You can use the object list to find an existing object of the required object type and configure it directly at the place of use. You can also use the object list to create new objects at the place of use.

Opening the object list

Objects are usually edited in the property view but can also be edited directly in the table in the work area when tabular editors are used. If WinCC flexible needs a connection to an object, the object list opens when you click on the object selection list. When, for example, you wish to configure a tag for the graphic object, click in the selection field for the tag. From the selection field, the object list opens offering you all of the available tags with suitable data type in the project for selection.

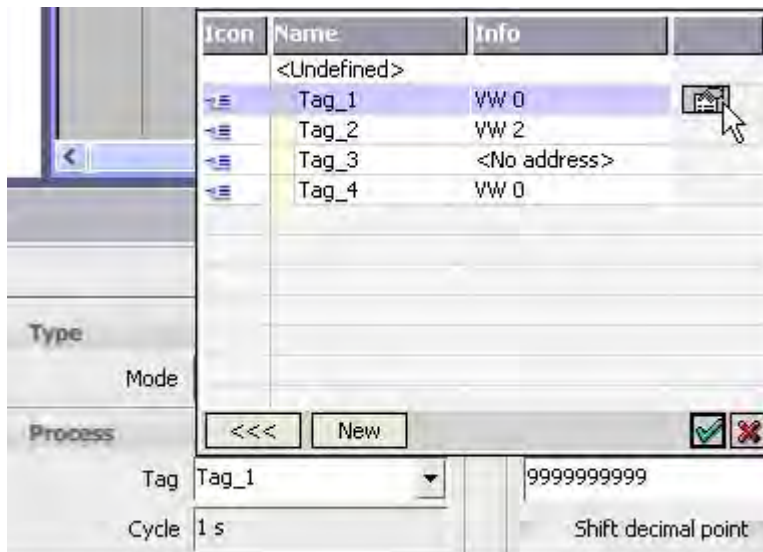

Object list

Select the required tag. Confirm your selection by pressing the  button.

Working with object lists

When a suitable object is not available in the project, create a new one using the object list. To create a new object, click on the "New" button in the object list.

A new object is created and the corresponding dialog for configuring this object opens. Configure the newly created object and close the configuration dialog.

You can also open and configure an existing object from the object list. Select the object from the object list. The  icon for editing is displayed in the right column. Click on the icon. The corresponding dialog for editing the object opens. Edit the properties of the object and close the configuration dialog.

2.7.9 Function List

Introduction

A function list is an attachment of system functions and/or scripts, which are executed successively when calling the function list. You can use the function list to trigger the execution of system functions at an event. The function list is configured for an event of an object, e.g. a screen object or a tag. The events which are available depend on the selected object. Events occur only when the project is in runtime. Events are, for example:

- Value changes of a tag
- Changing the value of the array = changing the value of an array element
- Pressing of a button
- Alarm occurrences

You can configure a function list precisely on every event. Up to 16 functions may be configured in a function list. When the configured event occurs in runtime, the function list is completed from top to bottom. In order to avoid waiting times, system functions with a longer running time, file operations, for instance, are processed simultaneously. A subsequent system function can be performed even if the previous system function has not yet been completed.

Configure function list

In WinCC flexible, open the editor containing the object for which you wish to configure the function list. Select the object with the mouse. In the property view, click on the event in the "Events" groups on which you want to configure the function list. The function list opens in the property view.

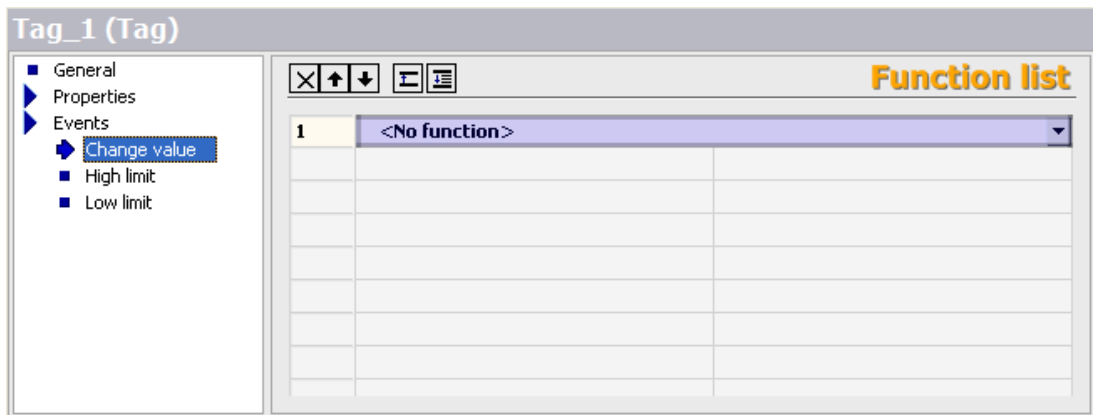

Function List

"No function" appears in the first line of the function list when no function has been configured for the object. Click on the "No function" field. A selection button is displayed. Use the selection button to open the list of available system functions. The system functions are arranged in the selection list according to categories.

Select the desired system function.

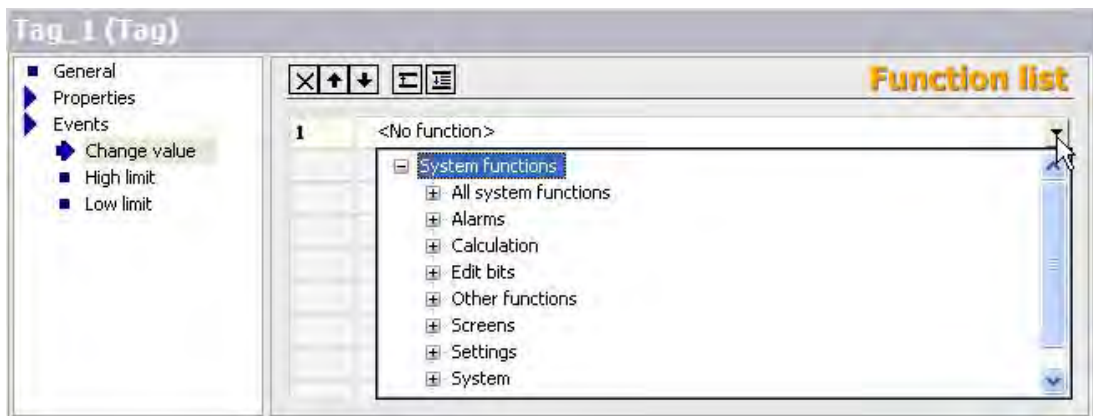

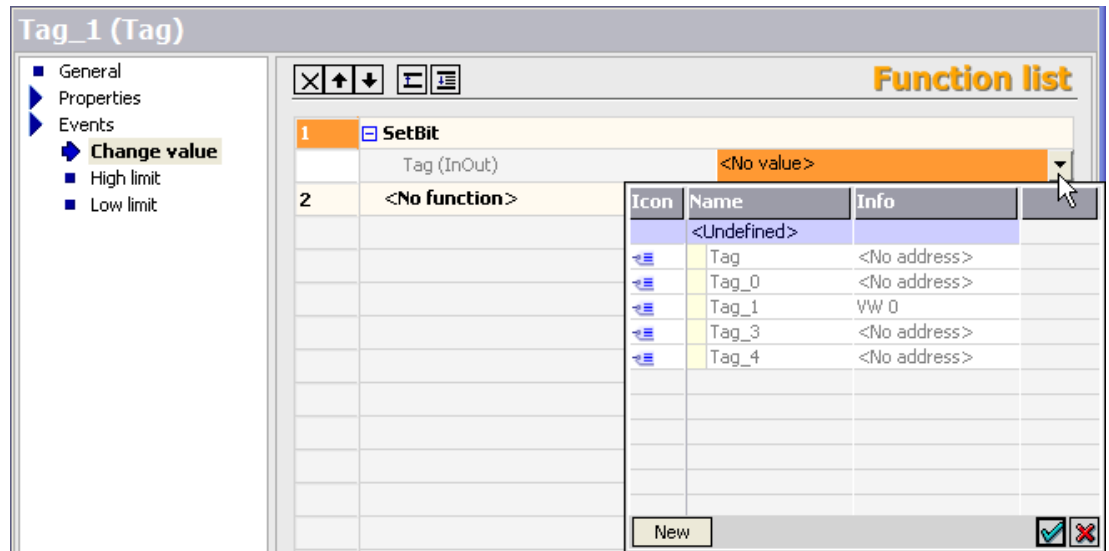

System functions

If a parameter is needed for the system function, the entry "No value" appears after the selection of the system function in the next line. Click on the "No value" field. A selection button is displayed. Use the selection button to open the object list and select the required parameter.



Parameter selection

The function is configured in the function list. Configure other functions as required. Using the buttons  and  change the sequence of the configured functions/scripts. Select a function and move the function up or down by clicking on the arrow buttons. To delete a function, mark the function with the mouse and press the key.

2.7.10 Text List

Introduction

In a text list the values of a tag are assigned to various texts. The text lists are created in the "Text lists".editor. The attachment of the text list to a tag is configured on the used object, for example on a symbolic IO field. These are the following application areas for the text list:

- For configuring a selection list with symbolic IO field
- For configuring a status-dependent button label
- For the configuration of a text output for the value of a discrete or analog alarm.
- For the configuration of a text output for the value of recipe data.

The texts in a text list can be configured multilingual. In runtime the texts are displayed in a set runtime language.

Configure text list

Open the editor "Text lists" by double clicking on the entry "Text lists" in the project view. By double clicking on the first empty line in the editor a new text list is created.

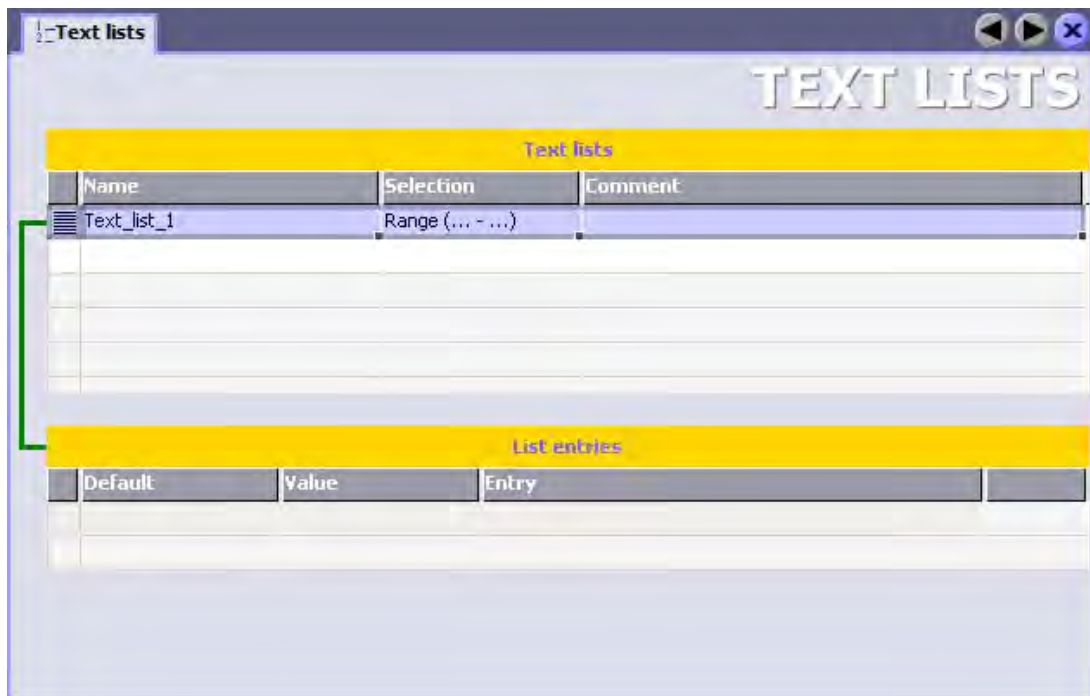

Click the column "Selection" and open the drop-down list box.

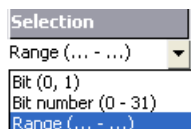

Select the corresponding field for the required text list. The following fields are available:

- Range (... - ...) With this setting the integer or value range of a tag is assigned to the text entries from the text list. The number of text entries may be selected freely. The maximum number of entries depends on the HMI device. You establish a default value that is then displayed if the value of the tags lies outside the defined area.
- Bit (0, 1) With this setting, the text entries from the text list are assigned to the two statuses of a binary tag. You can create a text entry for the status of a binary tag.
- Bit number (0 - 31) With this entry a text entry from the text list is assigned to every bit of a tag. The maximum number of the text entries is 32. This type of text list may, for example, be used in a sequential control when executing a sequencer wherever only one bit of the used tag is allowed to be set.

The least significant bit set and a default value determine the behavior of the bit number (0 to 31).

In the work area in the table "List entries" create the texts of the text list. Double-click the first line of the table. The first text entry has is created. In the column "Value" either set a binary value or a range value for the assigned tag to be used for the bit number.

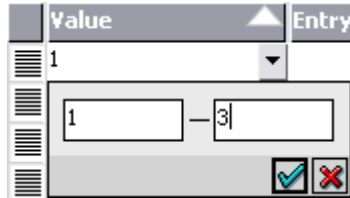

In the column "Entry" enter the desired text for the output. You can also insert output fields for entries of other text lists, tags and control tags. The control tag is the tag that selects the text list entry.

For the output of the tags, select the data type and the display format. Only the data types decimal, hexadecimal and binary are valid for the control tags.

Specify the field length for the output of text list entries.

Note

The number of reference to text list entries that in turn contain references to text list entries or tags is limited.

In order to create the next entry, double-click the next empty line in the table.

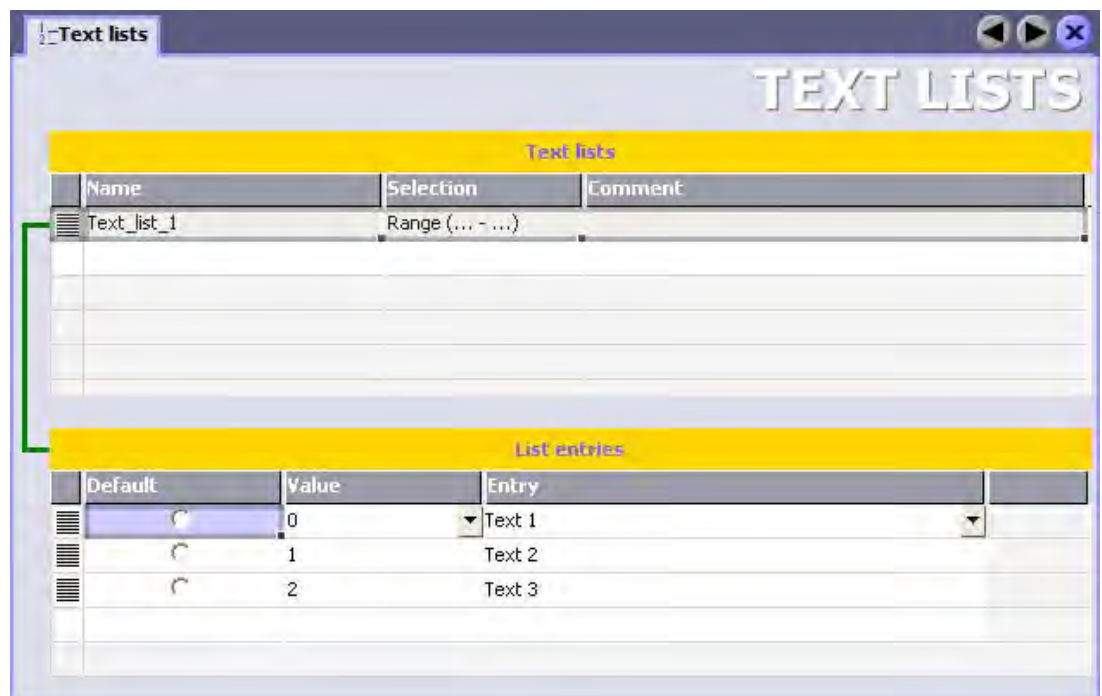

The entry in the column "Value" is uniquely assigned by the system. In order to change the value, click the corresponding entry. Open the drop-down list box and enter the desired value and range value.

Note

The availability of the text list is determined by the HMI device used.

Behavior of bit number (0 to 31)

If "Bit selection in text and graphics lists" is disabled in the "Device Settings" editor and no default value is set, the following standard response applies: If exactly 1 bit is configured for all set bits the saved at the configured bit will be displayed.

Example

Significance	7	6	5	4	3	2	1	0
Bits set	0	0	1	1	0	1	0	0
Configured	-	Text 3	-	Text 2	Text 1	-	-	-

Only the bit with significance "4" is configured. Text 2 is displayed.

Nothing is displayed in all other cases:

- No bit is set, for example.
- Several bits are set, for example.

Default value

In order to prevent an empty display in such a case, you establish a default value. A configured default value is displayed in the following scenarios:

- "Bit selection in text and graphic lists" is deactivated and in the tags there is not precisely 1 bit set that is also configured.

Example

Significance	7	6	5	4	3	2	1	0
Bits set	0	0	1	1	0	1	0	0
Configured	-	Text 3	Text 2	Text 1	-	-	-	Text 0

Two bits are set and configured. The configured default value is displayed.

- "Bit selection in text and graphic lists" is activated and no bit is set or if a bit with the smallest value is set, then no text is configured.

Click on an entry in the "Default" column of the "List entries" table to display a default value. You can also enter "Default" as "Value", or activate the "Default" check box at the "General" category in the "Settings" area of the Properties window.

Least significant bit set

If "bit selection in text and graphic lists" is activated, the displayed text is that which was configured for the set bit with the smallest value.

Example

Significance	7	6	5	4	3	2	1	0
Bits set	0	0	1	1	0	1	0	0
Configured	-	Text 3	-	Text 2	-	Text 1	-	-

The set bit with the least significance is "2." Text 1 is displayed.

Nothing is displayed if neither a text, nor a default value is configured for the least significant bit. The default value is displayed, if this is configured.

To visualize only the text that is assigned to the least significant bit, enable "Bit selection in text and graphics lists" in the "Runtime settings" area in the "Device settings" editor.

For reasons of downward compatibility, the setting is disabled as standard. The setting applies to all text lists of the HMI device.

Multiline text list entries

A line break is entered in the "Text list" editor using the "<SHIFT>+<Return>" shortcut. Alternatively, you can enter the line break with "Return" using the properties dialog. Line breaks are displayed using the "¶" carriage return symbol.

Multi-line text list entries are only output over several lines in symbolic output fields and on buttons. In all other cases, the multi-line texts are displayed using the "¶" carriage return symbol, such as message line or symbolic I/O field.

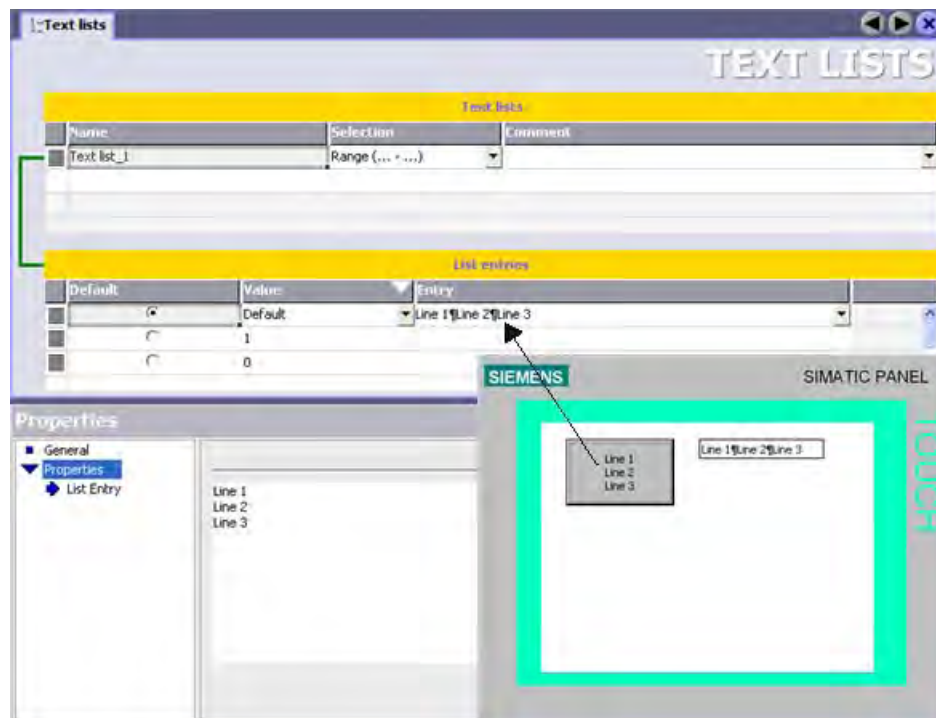

2.7.11 Graphics list

Introduction

In a graphics list, the values of a tag are assigned to various screens or graphics. The graphics lists are created in the "Graphics lists" editor. The attachment of the graphics list to a tag is configured on the used object, for example on a symbolic graphic field. These are the following application areas for the graphics list:

- For the configuration of a drop-down list box with a graphic IO field.
- For configuring a status-dependent representation of a button

The graphics in a graphics list can be configured as multilingual. In runtime the graphics are displayed in the set runtime language.

Configuring the graphics list

Open the "Graphics lists" editor by double-clicking the entry "Graphics lists" in the project view. By double-clicking the first empty line in the editor a new graphics list is created.

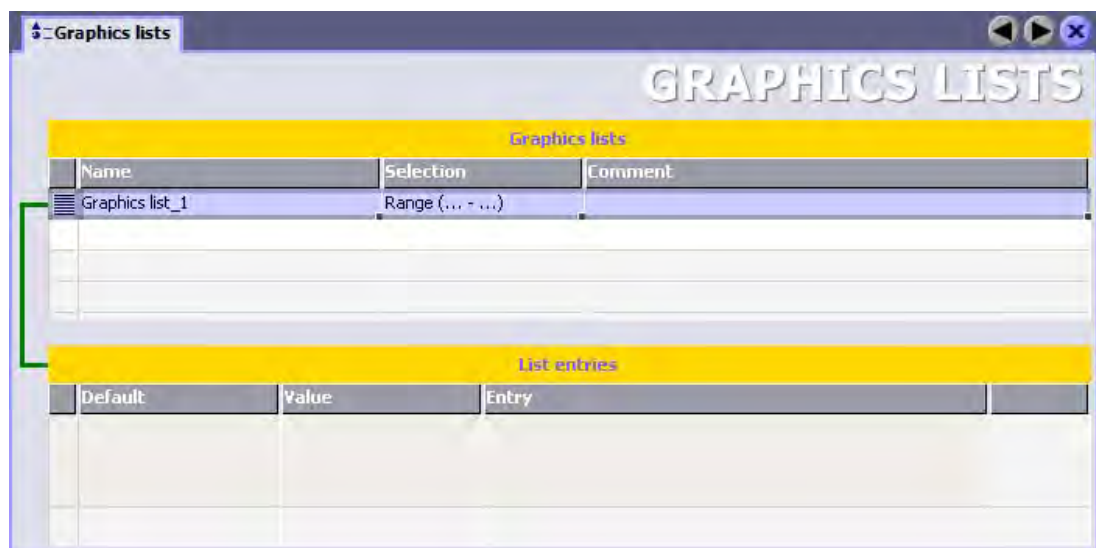

Click the column "Selection" and open the drop-down list box.

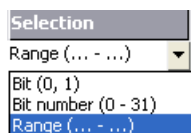

Select the corresponding field for the required graphics list. The following fields are available:

- Range (... - ...) With this setting the integer or value range of a tag is assigned to the graphics from the graphics list. The number of graphics may be selected freely. The maximum number of entries depends on the HMI device.
You establish a default value that is then displayed if the value of the tags lies outside the defined area.
- Bit (0, 1) With this setting, the graphics from the graphics list are assigned to the two statuses of a binary tag. You can create a text entry for every status of a binary tag.
- Bit number (0 - 31) With this entry a graphic from the graphics list is assigned to every bit of a tag. The maximum number of the graphics entries is 32. This type of graphics list may, for example, be used in a sequential control when executing a sequencer wherever only one bit of the used tag is allowed to be set.

The least significant bit set and a default value determine the behavior of the bit number (0 to 31).

In the work area in the table "List entries" create the graphics of the graphics list. Double-click the first line of the table. The first graphic entry is created.

In the column "Value" either set a binary value or a range value for the assigned tag to be used for the bit number.

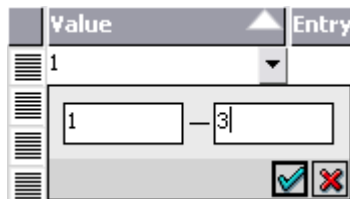

In the column "Entry" enter the desired graphic for the output.

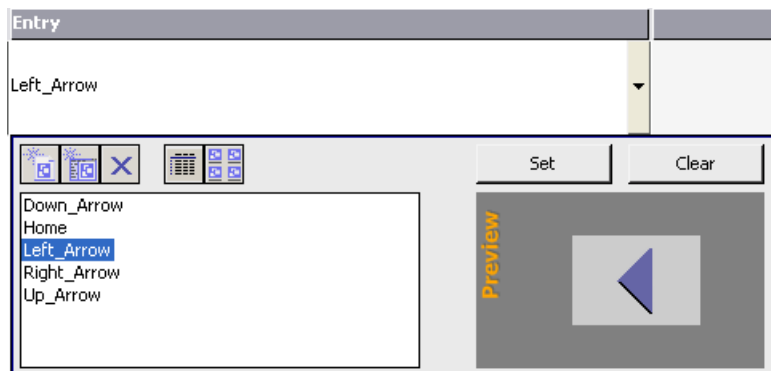

In order to create the next entry, double-click the next empty line in the table.

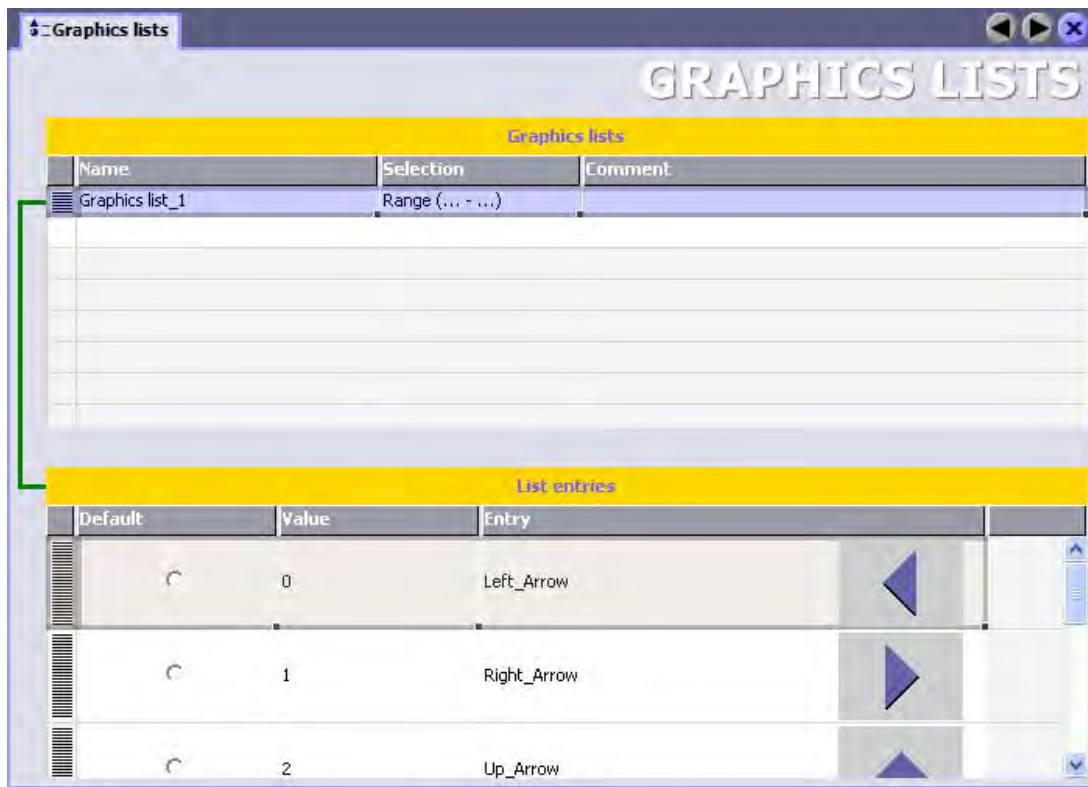

The entry in the column "Value" is uniquely assigned by the system. In order to change the value, click the corresponding entry. Open the drop-down list box and enter the desired value and range value.

Note

The availability of the graphics list is determined by the HMI device used.

Behavior of bit number (0 to 31)

If "Bit selection in text and graphics lists" in the device settings is deactivated and no default value is set, the following standard response applies: If only one of all set bits is configured the image saved at the configured bit is displayed.

Example

Significance	7	6	5	4	3	2	1	0
Bits set	0	0	1	1	0	1	0	0
Configured	-	Image 3	-	Image 2	Image 1	-	-	-

Only the bit with significance "4" is configured. Image 2 is displayed.

The cactus image is displayed in all other cases:

- No bit is set, for example.
- Several bits are set, for example.

Default value

In order to prevent an the cactus graphic from being displayed in such a case, you establish a default value. A graphic configured for a default value is displayed in the following scenarios:

- "Bit selection in text and graphics lists" is deactivated and in the tags there is not precisely 1 bit set that is also configured.

Example

Significance	7	6	5	4	3	2	1	0
Bits set	0	0	1	1	0	1	0	0
Configured	-	Image 3	Image 2	Image 1	-	-	-	Image 0

Two bits are set and configured. The configured default value is displayed.

- "Bit selection in text and graphics lists" is enabled and no bit is set or if a bit with the smallest value is set then no graphic is configured.

Click on an entry in the "Default" column of the "List entries" table to display a default value. You can also enter "Default" as "Value", or activate the "Default" check box at the "General" category in the "Settings" area of the Properties window.

Least significant bit set

If "Bit selection in text and graphics lists" is activated, the displayed graphic is that which was configured for the set bit with the smallest value.

Example

Significance	7	6	5	4	3	2	1	0
Bits set	0	0	1	1	0	1	0	0
Configured	-	Image 3	-	Image 2	-	Image 1	-	-

The set bit with the least significance is "2". "Image 1" is displayed.

The cactus image is displayed if neither an image, nor a default value is configured for the least significant bit. Any configured default value is configured the image configured for this default value is displayed.

Enable the "Bit selection in text and graphics lists" in the "Runtime settings" area of the device settings in order to visualize only the text that is assigned to the least significant bit.

For reasons of downward compatibility, the setting is disabled as standard. The setting applies to all graphics lists of the HMI device.

2.7.12 Displaying Help

Shortcut help

A tooltip will appear after moving the mouse pointer over any object, icon, or dialog element.



A question mark next to the tooltip indicates that a shortcut help is available for this user interface element. To call up an additional explanation to the short description, click on the question mark, press <F1> if the tooltip is activated, or move the mouse cursor to the tooltip.

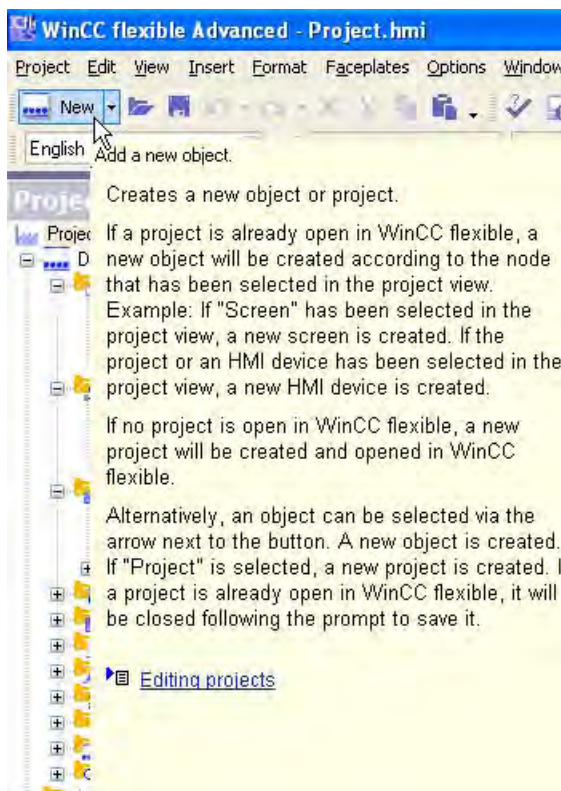

The explanation includes references which refer users to a detailed description in the Online Help.

Online help

In the "Help" command menu you can access the online help. When you use the "Help > Contents" menu command, the WinCC flexible Information System opens with an opened table of contents. Use the table of contents to navigate to the desired topic.

Alternatively select the "Help > Index" menu command. The WinCC flexible Information System opens with an opened index. Use the index to search for the desired topic.

In order to use the full text search across the entire WinCC flexible Information System select the "Help > Search" menu command. The WinCC flexible Information System opens with a search tab. Enter the desired search term.

The WinCC flexible Information System can also be opened via the Start menu in Windows. Select the menu command "Start > SIMATIC > WinCC flexible > WinCC flexible Help System" in the task bar.

The Online Help system is opened in a separate window.

2.7.13 Customized setup of WinCC flexible

Introduction

WinCC flexible allows you to customize the position and reaction of windows and toolbars. This allows you to configure the work environment to meet your special requirements.

Working Environment User-Dependency

The appearance of WinCC flexible is linked to the user logged on in Microsoft Windows. On saving the project, the positions and behavior of windows and toolbars are automatically saved with it.

When the project is opened again, the project status loaded is identical to that when saved. In this way, the working environment is opened as it was when last closed. This is also the case when a project edited by a different project planner is opened.

Resetting the work environment

The positions of views and toolbars can be reset to their original state. To do this, select "Reset layout" in the "View" menu.

2.8 WinCC flexible Start Center

Introduction

With WinCC flexible supports the accelerated opening of projects. For the accelerated start, while the operating system is booting, some services for WinCC flexible are launched in the background. To operate the WinCC flexible Start Center, during the installation a symbol is created in the Taskbar Notification Area, the so-called Tray area of the taskbar.



Start Center Symbol

WinCC flexible Start Center Menu Commands

The popup menu for operating the Start Center is opened with a right mouse click on the symbol in the Tray area of the taskbar. This includes the following menu commands:

Menu command	Function
Start WinCC flexible	Starts WinCC flexible and opens the project wizards.
WinCC flexible Start Center ► Enable	Enables the quick start for WinCC flexible, necessary services for the quick start are loaded during start-up of the operating system.
WinCC flexible Start Center ► Disable	Disables the quick start for WinCC flexible, no additional services are launched during start-up of the operating system.
Help	Opens the WinCC flexible Start Center online help.
Info...	Opens a window displaying the version information for the Start Center.
End	Ends the Start Center.

Start WinCC flexible

During the installation of WinCC flexible, WinCC flexible Start Center is also automatically installed and enabled. Restart the computer in order for Start Center to take effect. Select "Run WinCC flexible" in the Start Center popup menu to start WinCC flexible. Alternatively, launch WinCC flexible via the desktop icon. WinCC flexible is activated and the project wizard displayed. Then project wizard assists you with further instructions.

Information for an accelerated start of projects integrated in STEP 7 can be found in chapter "Start WinCC flexible in STEP 7".

Note

You need write permissions for the folders listed below during the initial start of WinCC flexible:

"Documents and Settings\All Users\Application data\Siemens AG\SIMATIC WinCC flexible" and "Documents and Settings\All Users\Application data\Siemens AG\SIMATIC WinCC flexible 2008\Caches".

The system generates template files in these folders during initial startup in the current WinCC flexible GUI language. You also require write permissions when you initially set up a new GUI language for a project.

Disable Start Center

To disable WinCC flexible Start Center, select the menu command "WinCC flexible Start Center > Disable" in the WinCC flexible Start Center popup menu. When you next restart the computer WinCC flexible components will no longer be launched in the background.

Working with projects

3.1 Basis for working with projects

3.1.1 Working with projects

Projects in WinCC flexible

The WinCC flexible configuration software is used to configure the user interface for controlling machines and systems. These can involve simple text display units for reading parameters but also complex operating stations for the production line, for example.

WinCC flexible has a modular design. You decide which HMI device types can be configured through the selection of a WinCC flexible edition. If necessary, a WinCC flexible edition can be upgraded to a later edition without any problem.

You can configure a maximum of 8 HMI devices in a WinCC flexible project.

A WinCC flexible project contains all of your configuration data for a plant or an HMI device. Configuration data includes:

- Process screens, to display the process.
- Tags, to transfer data between PLC and HMI device in runtime.
- Alarms, to display operational states in runtime.
- Logs, to save process values and alarms.

All data related to a project is stored in the database integrated in WinCC flexible.

Application example

WinCC flexible can be used, for example, to process the following scenarios:

- Configuring an HMI device installed permanently at machine level.

This represents the most common type of configuration in which the HMI device is permanently installed on the system or machine.

- Use of mobile units

Mobile units are generally used in the case of large production sites or lines, or material conveyor technology. The machines to be operated are equipped with several interfaces to which the Mobile Panel 170, for example, can be connected.

The operator or service technician can thus work directly on site. This enables an accurate setting up and positioning, e.g. during the startup phase. In the case of servicing, mobile units ensure shorter downtimes.

- Configuring several HMI devices

It is possible to connect several HMI devices to a system or machine. The system can then be operated from various points. Using WinCC flexible, it is possible to configure several units in one project, even of different types, which can work with the same project data.

Managing projects in Windows Explorer

WinCC flexible creates a project database on the hard disk when you save a project. The project database is stored in the Windows file manager with the extension *.hmi. A log file (*_log.ldf) is stored for each project database. Consistency of data cannot be guaranteed without this log file.

The project database can be moved, copied and deleted together with the corresponding log file in the Windows Explorer, as you are used to with other files. However, ensure that the database and the log file are not separated from each other during copying and moving.

For further information, refer to Working with Projects in section "Managing projects in the Windows Explorer."

Background loading when a project is opened

If working memory of a configuration computer is greater than or equal to 1 GB, background loading is started after you open a WinCC flexible project. Background loading includes various components of WinCC flexible at startup in order to improve performance when working with WinCC flexible.

Execution of the operations in the Engineering System may be delayed until background loading is completed. Background loading can take up to one minute, depending on the computer configuration. The response time of the Engineering System returns to normal after background loading was completed.

3.1.2 Component parts of a project

Principle

A WinCC flexible project consists of all the configuration data which enables the system to be operated and monitored. The configuration data is compiled in WinCC flexible according to topic categories. Each category is processed in an individual editor.

The editors available for use depend on the WinCC flexible edition used and the HMI device to be configured. The working environment of WinCC flexible only displays the editors supported by the HMI device currently in use. This means that configuration is simple and easy to follow.

If you want to log projects, it is sufficient to back up the [project name].hmi, [project name]_log.lfd files. Before you continue with delta compilation, you must also back up the [project name].rt and [project name]_RT_log.LDF files. The "*.fwx" and "*.pwx" files can be generated as required.

3.2 Types of projects

3.2.1 Types of projects

Principle

Different types of projects can be created using WinCC flexible. The type of project is dependent on the system configuration, the size of the system or machine, the required representation of the system or machine and the HMI devices used for operating and monitoring.

The following project types can be configured in WinCC flexible:

- Single-user project
Project which is used for a single HMI device.
- Multi-user project
Project in which several HMI devices are configured.
- Project for use on different HMI device

Single-user project

In most cases, only one HMI device is configured. During the configuration phase, a project always displays precisely the function range which is supported by the currently selected HMI device.

Multi-user project

If several HMI devices are used to operate a system, WinCC flexible can be used to create a project in which several HMI devices are configured. This type of project is used, for example, when the machine or system controlled is operated from several different points. Common objects can then be used in the project. This method means that a project need not be created for each separate HMI device, but rather all HMI devices are managed in the same project.

A WinCC flexible project consists of all the configuration data which enables the system to be operated and monitored. Each configured unit only displays the functions which the specific unit supports. Functions which are not supported are hidden but remain a component part of the project data.

Project for use on different HMI device

A project can be created for a specific HMI device and loaded onto several different HMI devices. When loading onto the HMI device, only that data is loaded which is supported by the HMI device.

3.2.2 HMI device dependency of projects

Principle

The functions of the HMI device determine project visualization in WinCC flexible and the functional scope of the editors.

Selecting Operating Unit Types

You select the type of the first HMI device when you create a project. The HMI device type can be changed in the Project View shortcut menu of the HMI device. You can retroactively install new HMI devices using the Hardware Support Package.

Note

Replacing the type of HMI device

- After changing the HMI device type, all configured data are still contained in the project file. In the Engineering System, only the functions are still available and only the configuration data that are supported by the current HMI device are displayed. This involves, for example, logs, recipes, available objects in screens, available system functions, and available communication protocols.
 - If you change the HMI device type in a WinCC flexible project and later change it back again, a warning can be output that the height or the width of a display object is 0. This behavior results if the height or width of an object is set to 0 when you change to an HMI device with a smaller display. When you later change to an HMI device with a larger display, the value 0 can no longer be converted to a meaningful size. Correct the object size manually
-

Functions dependent on the HMI device

Apart from changing the functional scope when switching from one HMI device type to another, the following features must also be considered:

- Colors supported

When switching from an HMI device with color display to another with a smaller color range, the color is changed automatically. If you change the colors yourself for an HMI device with a smaller color range and you change back to an HMI device with a larger color range, the reduced color range is retained.

- Navigation buttons

Recompile the project after changing the HMI-device type. The compiling ensures that all screens are converted to the current HMI device.

If you then change the HMI device again without generating first, it is possible that the navigation buttons will be shown differently in the individual screens.

- Fonts

If a "font" which has been configured is not available on the HMI device, it is replaced by a similar one or the configured "standard font." The "standard font" is dependent on the HMI device selected.

- Character sets with different font sizes

In projects for the HMI devices OP 73micro, TP 177micro, OP 73, OP 77A and TP 177A, avoid using many different font sizes. For each font size a character set is loaded on the HMI device. When you generate the data, check the output view to determine HMI memory resources used by the character sets.

- Font size

In order to display the text on HMI devices, use small Windows fonts. If you use large Windows fonts, then, depending on the size of the display, the text will not be displayed in full.

The use of font sizes of 20 point or more on the HMI devices OP 77A, TP 177micro and TP 177A affects performance. For an effective configuration, note the following points:

- Use the same font for all large characters throughout the project. Arial and Tahoma are the best suited for this.
- Avoid font sizes larger than 72 point.

- Resolution

When switching from an HMI device to another with a lower resolution, there are two options available: All screen objects can be automatically scaled. All screen objects can be left in their original size. Objects at the lower or right side of the screen that overlap the displayable screen will not be displayed. To display these hidden objects, select the screen background and select "Display hidden objects" in the shortcut menu. In the dialog that opens, you can select individual objects or all objects and move them to the visible area of the screen by pressing "OK."

Note

Because HMI devices with a display size less than 6" have the same width but different heights, you should turn off the automatic scaling when replacing the HMI device. Because the width remains the same, automatic scaling would change only the height of the objects, causing them to become distorted. To enable or disable automatic scaling, select the "Options > Settings" menu command. In the "Settings" dialog that opens, click "Settings for screens editor" in the "Screens editor" group. Enable or disable the "Fit screens and screen objects to new HMI device" option.

- HMIs with DP configuration

The DP configuration is not altered when you replace an HMI with DP configuration. The HMI can not be operated in Runtime if the DP configuration does not match, for example, when using an incompatible DP slave. Always check the DP configuration, and the existence of appropriate DP modules in HW Config, when you replace an HMI.

- Tab sequence of unavailable objects

Any configured object which is not supported on an HMI device is not displayed. The tab sequence number of the object which is no longer displayed is transferred to the next object of the tab sequence. Adapt the object number to the changed tab sequence number if you have used the tab sequence number when configuring the ActivateScreenByNumber system function.

Selecting the operating system version of the HMI device

When you configure a new HMI device, WinCC flexible automatically selects the latest operating system version.

If you want to use a new version on an HMI device with an older operating system version, you must transfer an image of the relevant firmware version to the HMI device.

WinCC flexible provides the required images for the supported HMI devices. You can find further information in chapter "Operating System Transfer".

If you must use an older operating system version for compatibility reasons, you must convert the WinCC flexible project to the previous version. The version of the HMI device is automatically set to the previous version during conversion. You can find further information in the chapter "Converting projects".

If you want to use an older version on an HMI device with the current operating system version, you must transfer an image of the relevant firmware version to the HMI device. WinCC flexible provides the required images for the supported HMI devices. You can find further information in chapter "Operating System Transfer".

Information on the HMI device versions used in WinCC flexible is to be found in FAQ on the Internet under the article ID 21742389.

[Link to information on HMI device versions](#)

3.2.3 Configuring a project for several HMI devices

Principle

Using a WinCC flexible edition from "Compact" and later, a project can be configured with several HMI devices.



You can delete, copy (also across projects) and rename the HMI devices in the project window.

Application example

This type of configuration is used, for example, in projects designed for large systems which are to be operated by several HMI devices.

Global data and HMI device-specific data

Within a project, in which several HMI devices are configured, some data and objects are available specific to HMI devices and some are globally available throughout the project.

- HMI device-specific data

Data related to a specific HMI device can be individually setup in the project. HMI device-specific data and objects are all data and objects that are listed in the Project View below the entry "Device", e.g. pictures, communication, recipes or logs.

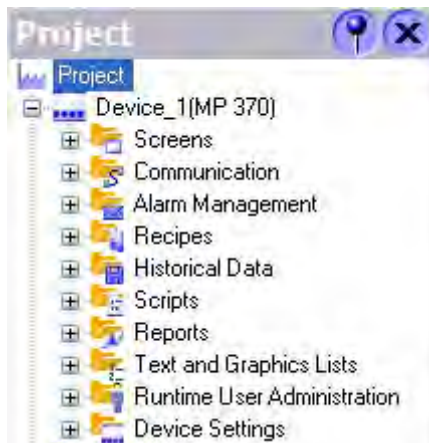

- Global project data

Global project data applies to all HMI devices within the entire project. It applies to all data and objects in the Project View at the same level as the "Device" option, e.g. "Language" or "Version management."



Number of HMI devices in a project

Up to 5 HMI devices can be configured within a WinCC flexible project. Although WinCC flexible supports the opening of projects with more than 5 devices, e.g. from WinCC flexible 2005, the creation of further devices will be prevented.

3.2.4 Creating a project for use on different operating units

Principle

It is possible to create a single project and to load it on several different HMI devices.

Application example

This type of configuration is typically used for several operating units of a similar type but with different performance, for example.

Special aspects of configuration

Proceed as follows to use a project for different HMI devices:

- Create a project for a specific operating unit type, normally for the operating unit with the smallest functional scope.
- Copy the configuration for the operating unit in the Project View.
- Test the feasibility for other operating units by switching the operating unit type in the project.

Pay particular attention to the following aspects:

- After switching the operating unit type, all configured data are still contained in the project file. However, only that configuration data is displayed which is supported by the operating unit currently in use. This relates to editors, objects and object properties.
- WinCC flexible not only checks the functional scope of an operating unit but also its limitations. If only a specific number of tags can be used on an HMI device, for example, the corresponding error message appears when transferring the project to the HMI device or when testing it in runtime.
- Always define the HMI version when you change the HMI type. Runtime and simulation can only be started if the new HMI device versions are configured. Information on the HMI device versions used in WinCC flexible is available in the FAQs on the Internet at the article ID 21742389.

[Link to information on HMI device versions](#)

3.2.5 WinCC flexible integrated in SIMOTION and STEP7

Introduction

WinCC flexible operation can be operated in SIMATIC STEP 7 and SIMOTION SCOUT starting with the WinCC flexible Compact edition. Integration has the following advantages:

- The tags and texts are imported into the WinCC flexible project.
- Direct access to SIMATIC STEP 7 symbols and SIMOTION SCOUT symbols during process connection.
- The texts and attributes contained in the alarm configuration are imported into WinCC flexible.
- The configuring overhead is reduced thanks to the common use of configuration data.

A condition for integrated operation in SIMOTION SCOUT is that SIMATIC STEP 7 and SIMOTION SCOUT are installed on the configuration computer. The installation sequence is:

1. SIMATIC STEP 7
2. SIMOTION SCOUT
3. WinCC flexible

WinCC flexible integrated in SIMATIC STEP 7

When installing WinCC flexible, the user defines whether WinCC flexible should be integrated in SIMATIC STEP 7. The integration of SIMATIC STEP 7 in the configuration interface offers the following advantages:

- Better fault tolerance
- Less work for modifications
- Less configuration work

During configuration, direct access is made to the SIMATIC STEP 7 symbol tables, data areas, and controllers from SIMATIC STEP 7. The icon table contains data point definitions (e.g. addresses and data types) defined during creation of the PLC program.

The WinCC flexible project tree is mirrored in the project tree of SIMATIC Manager. The objects are edited, however, in a separate WinCC flexible application with the independent WinCC flexible ES user interface.

Further information on the use of SIMATIC STEP 7 is provided in the documentation of STEP 7.

WinCC flexible integrated in SIMOTION SCOUT

When installing WinCC flexible, the user defines whether WinCC flexible should be integrated in SIMOTION SCOUT.

HMI devices with SIMOTION SCOUT connection are configured in the SIMOTION SCOUT working environment.

When WinCC flexible and SIMOTION SCOUT are installed on a configuration computer, WinCC flexible is integrated in the SIMOTION SCOUT working environment. Work is then performed in a single working environment for all tasks from the SIMOTION SCOUT or WinCC flexible environment.

A WinCC flexible project appears as a node in the SIMOTION SCOUT project tree. All operating units configured in a project appear as sub-entries of the project tree. The WinCC flexible editors are opened parallel to the SCOUT editors in the SCOUT user interfaces.

Further information about using SIMOTION SCOUT is provided in the "SIMOTION SCOUT" documentation.

Opening integrated projects

A conversion starts by default if a WinCC flexible project originating from an older version is initially opened in WinCC flexible 2008. Conversion may take some time; it can also take several hours for large-scale projects.

The conversion progress is shown on a display if you open the project directly in SIMATIC Manager. This does not show the actual progress if you are handling large-scale projects. In this case, CPU utilization of the computer indicates that conversion is still running.

Do not interrupt the conversion process.

3.3 Multilingual configuration

Multilingual configuration

You can configure your projects in multiple languages using WinCC flexible. WinCC flexible supports the multilingual configuration of practically all objects with texts displayed in runtime.

WinCC flexible can be used for configuration in all languages installed in the operating system.

In addition to direct text input in the editors, WinCC flexible provides easy-to-use export and import features for translating projects. This is of particular advantage when configuring large projects with a large share of text.

Use the following editors to translate texts in WinCC flexible:

Toolbar	Short description
Project languages	Managing languages for the project texts
Languages and fonts	Defining the languages and fonts used in runtime
Project texts	Managing language-dependent project texts
Graphic browser	Managing local graphics
Dictionaries	Managing the system and user dictionaries

WinCC flexible multilingual user interface

You can change the GUI language in WinCC flexible in the course of configuring, for example, if several engineers of different nationality are working on a project configuration. During the installation of WinCC flexible, select the languages that will be required later.



The Setup language is installed as the default GUI language of WinCC flexible. The following languages can also be installed:

- Western European languages
 - German
 - Spanish
 - Italian
 - French
- Asian languages
 - Japanese
 - Chinese
 - Taiwanese
 - Korean

Note

WinCC flexible 2008 CHINA provides Chinese simplified as GUI language.

3.4 Editing projects

3.4.1 Editing projects

Objects and editors

The following objects can be created and edited in WinCC flexible.

- Screens

Screens are created and edited in the Screens editor. It is possible to define the navigation between screens in the "Screen navigation" editor.

- Faceplates

Faceplates are groups of objects which can be used as often as required in a project. Faceplates are stored in libraries.

- Graphics list

In a graphic list, the values of a tag are assigned to various graphics. The graphic lists are created in the "Graphic List" editor and displayed with the "Graphic IO Field" object.

- Text List

In a text list, the values of a tag are assigned to various texts. The text lists are created in the "Text List" editor and displayed with the "Symbolic IO Field" object.

- Language-dependent texts and graphics

Using WinCC flexible, projects can be created in different languages:

- The Project Languages editor is used to manage the languages in which the projects should run.
- The Project Texts editor is used to manage and translate language-dependent texts centrally.
- The Graphic editor is used to manage language-dependent graphics.
- The User Dictionary editor is used to create and manage dictionaries for translating project texts. The System Dictionary editor is used to view the system dictionary integrated in WinCC flexible.

- Tags

Tags are created and edited in the Tags editor.

- Cycles

It is possible to configure events in WinCC flexible which reoccur at regular intervals. The time intervals are defined in the Cycles editor.

- Alarms

Alarms are created and edited in the Analog Alarms and Discrete Alarms editors.

- Logs

The Alarm Log editor is used to log alarms in order to record operating statuses and faults which occur in a system.

The Data Log editor is used to compile, process and log process values.

- **Protocols**
The Reports editor is used to create reports with which the user prints alarms and process values, for example, in runtime.
- **Scripts**
WinCC flexible provides the option of making your projects dynamic using custom scripts. The scripts are managed in the Scripts editor.

The following tasks can also be completed in WinCC flexible:

Task	Editor
Configuration of controllers	Connections
Setting up users, user groups and assigning user rights for operation in runtime	Runtime user administration
Managing task-related jobs. It is possible to execute a job once or several times.	Scheduler
Setting up the device settings, such as start screen, language used.	Device settings
Managing different project versions	Version management

Unit dependency and editors

The representation of the project in the WinCC flexible Project View and the functional scope of the editors are dependent on the HMI device selected. Please refer to your manual to determine which objects and editors are available on your HMI device.

Tabular editors and image editors

Graphical editors, such as the Screen editor, display the elements belonging to both the Project View and Object View. You open each object in the work area with graphical editors.

Tabular editors, such as the Tag editor, only display the associated objects in the Object View. When a tabular editor is opened to edit the objects, all associated objects are displayed in a table in the work area

Note

Font size for changing from an OP 73 to an OP 77 HMI device

When an HMI device is changed, the font size changes at certain screen objects such as at the alarm view. Deactivate the "Adapt screens and screen objects at device change" option in the "Options ▶ Settings ▶ "Screens" editor ▶ Settings for "Screens editor" ▶" menu.

3.4.2 Displaying projects

Principle

All component parts and editors available in a project appear in a tree structure in the Project View.

Displaying a project in the Project View

All editors available are displayed under the project node in the Project View. The objects in a project can be edited using the various editors.

Folders are provided as sub-elements of each editor in which you can save objects in a structured way. In addition, direct access to the configured objects is available for screens, recipes, scripts, logs and reports.

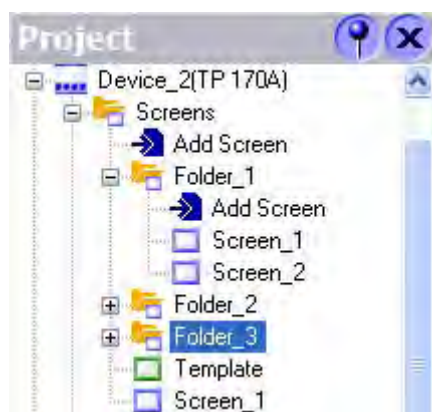

The Project View display is dependent on the HMI device selected when the project was created. Only those editors are displayed which are supported by the HMI device selected. If, for example, a "TP170A" is configured, the "Log" editor is not available because the "TP170A" does not have a logging function.

Select the project objects which are to be edited in the Project View. To do this, double-click on the relevant object. The corresponding editor will open.

Displaying objects in the Object View

The Object View displays the content and associated information of the respective folders and editors selected in the Project View. The Object View is displayed below the Project View by default.



The Object View is comprised of three columns:

- Object type
- "Name"
Name of the object



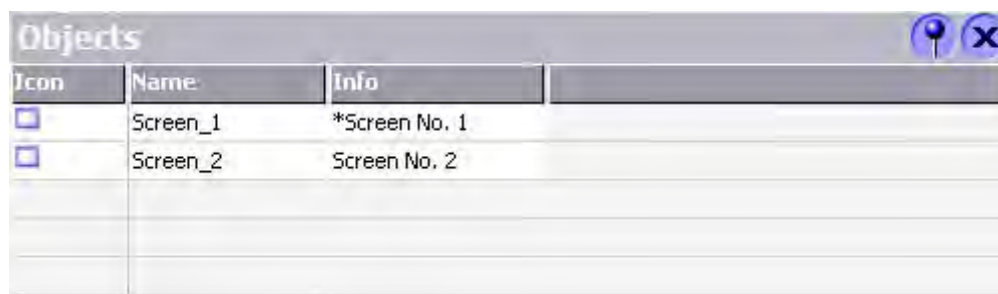













- "Info"

Brief information, e.g. a comment entered by the configuration planner



Icon	Name	Info
	Screen_1	*Screen No. 1
	Screen_2	Screen No. 2

Objects are displayed in the Object View by the following icons:

Symbol	Brief description	Symbol	Brief description
	Figure		Data log
	Tag		Alarm log
	Analog alarm		Protocol
	Discrete alarms		Connection
	System alarms		Cycle
	Alarm class		Text list and graphic list
	Alarm group		Users
	Recipe		User groups
	Task		

Working with the Object View

Double-click an object in the Object View to open the corresponding editor.

In addition, drag-and-drop actions can be performed on all objects displayed in the Object View. The following drag-and-drop actions, for example, are supported:

- Moving a tag to a process screen in the work area: This creates an I/O field linked to the tag.
- Moving a process screen to another process screen in the work area: Creates a "Change screen" button to the relevant process screen.

3.4.3 Working in the Project View

Principle

The representation of the project in the Project View can be used to edit projects.

The following actions can be executed in the Project View:

- Double-click
- Select a command in the shortcut menu
- Drag-and-drop actions

Double-click

A folder is opened by double-clicking on the folder in the Project View.

The editor is opened by double-clicking on an editor, e.g. "Tag" editor, or on an object, e.g. a screen, in the Project View.

Shortcut menus

After positioning the pointer on an object or folder and clicking the right mouse button, the respective shortcut menu appears. The following actions are available in the shortcut menu:

Action	Description
"Open editor"	Opens the editor
"Add folder"	Creates a new subfolder. The creation of subfolders enables the user to sort the objects according to topics.
"Delete"	Deletes the object or folder selected.
"Rename"	Enables the object or folder selected to be renamed.
"Undo"	Reverts the last process.
"Cut"	Copies the object or folder in the clipboard and deletes it.
"Copy"	Copies the object or folder in the clipboard.
"Paste"	Inserts the object stored in the clipboard.
"Print selection"	Prints the object or folder selected.
"Cross-reference"	Shows all places of use for the selected object or folder.
"Properties"	Shows the properties of the object or folder selected.

Drag-and-drop actions

Drag-and-drop can be used for the following actions:

- Inserting objects in an editor

Drag an image from the Project View and drop it in another screen. The screen is then assigned a button which, when clicked, switches the screen content back to the first screen.

- Moving or copying objects in subfolders

If the Project View simultaneously contains objects and subfolders, an object can be moved to a subfolder by means of drag-and-drop or copied.

3.4.4 Working in the Object View

Principle

The Object View provides an overview of the objects.

The following actions can be executed in the Object View:

- Double-click
- Select a command in the shortcut menu
- Drag-and-drop

Double-click

A folder is opened by double-clicking on the folder in the Object View.

After double-clicking on an object (e.g. a screen) in the Object View, the editor opens.

Shortcut menus

The following actions are available in the shortcut menu:

Action	Description
"Open editor"	Opens the editor
"Add folder"	Creates a new subfolder. The creation of subfolders enables the user to sort the objects according to topics.
"Delete"	Deletes the object or folder selected.
"Rename"	Enables the object or folder selected to be renamed.
"Undo"	Reverts the last process.
"Cut"	Copies the object or folder in the clipboard and deletes it.
"Copy"	Copies the object or folder in the clipboard.
"Paste"	Inserts the object stored in the clipboard.
"Print selection"	Prints the object or folder selected.
"Cross-reference"	Shows all places of use for the selected the object or folder.
"Properties"	Shows the properties of the object or folder selected.

Drag-and-drop

Drag-and-drop can be used for the following actions:

- Inserting objects in an editor

Using drag-and-drop, an object can be dragged from the Object View into any editor when the editor permits editing of the object. An example of its application is the linking of tags to a screen. If a tag is dragged from the Object View into a screen, an I/O field is automatically created.
- Moving or copying objects in subfolders

If the Object View contains both objects and subfolders, an object can be moved to a subfolder by means of drag-and-drop or copied.

3.4.5 Migrating existing projects

Migrating projects from ProTool and WinCC

Projects can also be opened in WinCC flexible which were created with ProTool or WinCC. Such projects are automatically converted when the WinCC flexible edition installed supports the HMI device defined.

Instead of a file of the type "HmiProjects", open one of the following types in the "Open" dialog:

- ProTool project

On opening the project, all data is converted. Afterwards, the project can only be saved as a WinCC flexible project.

- WinCC project

Only WinCC Version 6.2 projects can be migrated to a very limited extent to WinCC flexible.

3.5 Converting projects

3.5.1 Projects of different WinCC flexible versions

Introduction

WinCC flexible automatically converts projects that were created with an earlier product version of WinCC flexible to the current version. This functionality enables you to edit projects that were created with an earlier version using the current WinCC flexible version. WinCC flexible also offers you the possibility of saving a project for an earlier product version. The converted project can only be edited further in the selected earlier product version.

Requirement

The "Save as version" function is installed. For additional information, refer to the installation instructions.

Conversion options

WinCC flexible can be used to convert projects for the available product versions.
The following conversion options are available:

Project created with	Convert to version
WinCC flexible 2008	WinCC flexible 2007
WinCC flexible 2007	WinCC flexible 2005 SP1
WinCC flexible 2005 SP1 HF7	WinCC flexible 2007 WinCC flexible 2005 WinCC flexible 2004 SP1
WinCC flexible 2005 SP1	WinCC flexible 2007 WinCC flexible 2005 WinCC flexible 2004 SP1
WinCC flexible 2005	WinCC flexible 2007 WinCC flexible 2005 SP1 WinCC flexible 2004 SP1
WinCC flexible 2004 SP1	WinCC flexible 2007 WinCC flexible 2005 SP1 WinCC flexible 2005
WinCC flexible 2004 HF2	WinCC flexible 2007 WinCC flexible 2005 SP1 WinCC flexible 2005

The system automatically converts a project from an earlier version of WinCC flexible to the current version when the project is opened. The command "Save as version" is available for saving a project in an earlier version.

WinCC flexible 2005 SP1 or higher versions support the conversion of projects which are integrated in STEP 7 or SIMOTION Scout. You can find further information in the chapter "Converting an integrated project."

The ProAgent folder is not displayed in WinCC flexible

Install the ProAgent option before running a complete conversion of projects with ProAgent elements. Start the corresponding customized installation.

3.5.2 Differences between projects of different WinCC flexible versions

Introduction

A number of special features should be observed when editing projects for different versions of WinCC flexible. You can only use new functionality for a project that is to be saved in an earlier version of WinCC flexible to a limited extent. When carrying out configuration for an earlier version of WinCC flexible, only use functionality that is supported in the desired target version. New functionality from a more current WinCC flexible version is not supported in an earlier version of WinCC flexible.

System requirements for converted projects

To edit a converted project, you require WinCC flexible in the version selected during conversion. A service pack in the version specified must be installed. Please also note the system requirements and any service packs required for the operating system. Information on the system requirements can be found in the documentation of the respective version of WinCC flexible. With regard to an invalid HMI device, check whether a hardware support package is available for the corresponding version of WinCC flexible.

HMI devices in libraries

The system automatically selects the HMI device version which matches the selected WinCC flexible version if you are using WinCC flexible to save a project in an earlier version. HMI devices in libraries are not automatically converted to an older HMI-device version. If you want to use this kind of HMI device in the earlier WinCC flexible version, you have to adjust the HMI-device version after adding the HMI device using the dialog for changing the devices.

Displaying alarm classes

When you save a WinCC flexible project in an earlier version, no alarm classes are assigned to system events in the "System event" editor in the earlier version of WinCC flexible. This problem is specific to the view in the engineering system. The project can be executed in Runtime without any change of its configuration.

Screen navigation settings

When you save a WinCC flexible project from version WinCC flexible 2005 and later in the version WinCC flexible 2004 SP1, the default settings from the version WinCC flexible 2004 SP1 are used in the screen navigation. The use of the earlier default settings may alter the layout of the configured screen navigation. For example, the settings "Adapt to function keys" and the settings for additional rows and columns are eliminated for keyboard devices.

If you save a project in the version WinCC flexible 2005 or an earlier version with WinCC flexible, the background color of the screen objects is not used in the navigation bar.

Scripts in converted projects

When you save a project in a different version of WinCC flexible, differences in the functional scope of the different versions may result in inconsistencies in a script.

To eliminate inconsistency of the scripts, open the script of the converted version in the "Scripts" editor then run the "Check syntax" function.

OPC connection in converted projects

In a converted project, you have to manually adjust the OPC Server name and the item name for an OPC connection with the help of the OPC XML Wrapper.

Version	OPC-Server name	Item name
WinCC flexible 2004 SP1	n OPC.Siemens.Xml 1 OPC.Siemens.XML, for example	Win CC Flexible RT<@>[tag name] Win CC Flexible RT<@>S7_Bool_Tag_out, for example
As of WinCC flexible 2005	OPC.Siemens.XML	[Prefix]:Win CC Flexible RT<@>[tag name] 1:Win CC Flexible RT<@>S7_Bool_Tag_out, for example

User password

The option of configuring user passwords with special characters is supported in WinCC flexible 2007 or higher. Passwords which contain special characters are not supported in previous versions of WinCC flexible.

A password which contains special characters is reset to the default value "100" if you convert a project as of WinCC flexible 2007 or higher into a previous version. Define a new password without special characters after having completed the conversion.

Functional differences

When you save a WinCC flexible project in an earlier version and transfer it to an HMI device on the basis of the earlier version, certain fixes and enhancements of functionality may cause functional differences.

3.5.3 Differentiation of HMI-device versions

Introduction

Due to functional extensions, a number of different HMI-device versions are available for the different versions of WinCC flexible. When you convert a WinCC flexible project to a different version, the appropriate HMI-device version must be used for the HMI device used.

Selecting the HMI-device version

The system automatically selects the HMI device version which matches the selected WinCC flexible version if you are using WinCC flexible to save a project in an earlier version. New HMI devices that are supported only in the current version of WinCC flexible can not be used in an earlier version of a WinCC flexible project. The system outputs a corresponding dialog box if you attempt to save a project in an earlier version containing an HMI device which is not available in the earlier version of WinCC flexible. If you confirm this dialog with "OK," the "Change device type" dialog will open. This dialog box shows all HMI devices supported in the selected WinCC flexible version. Select an appropriate HMI device. The project is converted and saved to the selected HMI device. If you select "Cancel" in the dialog, the save operation will be cancelled and a conversion will not be performed.

When you convert a project from an earlier version with the current version of WinCC flexible, the HMI-device version is automatically converted to the current version during conversion. The current operating system version must be installed on the HMI device before the project is transferred. You can find further information in chapter "Operating System Transfer".

The current version of WinCC flexible allows you to configure different HMI device versions. Select the HMI-device version before making changes to the existing project. After conversion of the HMI-device versions, all the existing configuration data are still included in the project file. In the engineering system, only the functions are still available and only the configuration data that are supported by the current HMI device in the selected version are displayed. You can find further information in the chapter "Project HMI device dependency".

3.6 Reusing project data

3.6.1 Copying mechanisms

Overview

In WinCC flexible, copy the objects into the clipboard and insert the copied objects on another HMI device in the same project or into a different project. In order to understand the different copying processes in WinCC flexible, two different types of object connections need to be differentiated.

The "Reference" specifies a non-exclusive connection between two objects. The reference object may also be referenced by additional objects. A tag or an log may for example be used by different objects of a program.

In comparison to a reference there are objects with an exclusive relationship to each other, a so called "Parent-child relationship". Parent-child relationships are for example a screen and the objects contained in it, or a screen folder containing screens.

There are two different copy mechanisms available for copying.

Using the command "Flat copy" the selected object and contained child objects will be copied. References are not copied during a flat copy.

The command "Copy" will copy the selected object together with the child objects and the existing references.

Note

Copying multilingual objects

The copies of multilingual objects to a different project only include text objects in the project languages which are activated in the target project. Activate all project languages in the target project to include the corresponding text objects when transferring the copy.

3.6.2 Flat copy

Flat copy

"Flat copy" will copy those objects with a parent-child relationship completely. If you want to copy a screen, then all the contained objects will be copied. With "Flat copy" the reference will simply be copied as an "open reference". A placeholder object is copied, which only saves the name of the reference.

Example for a flat copy:

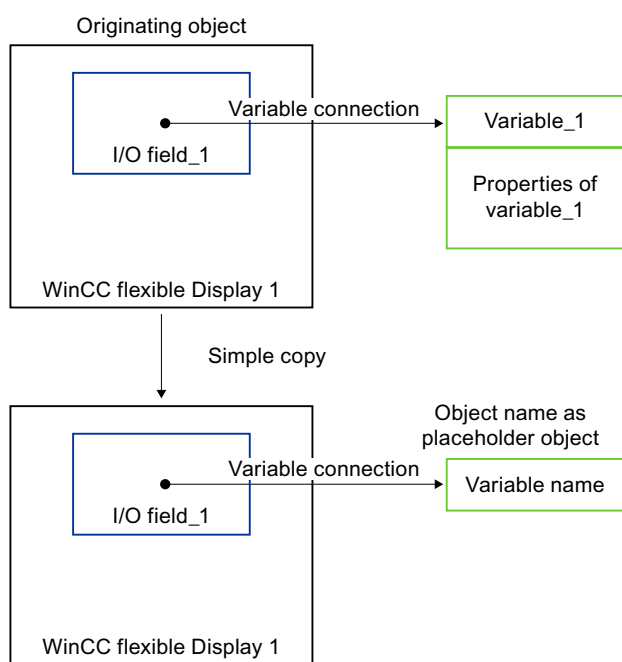

The WinCC flexible screen contains an I/O field with a tag connection. A flat copy will copy the WinCC flexible screen including the I/O field because the WinCC flexible screen and the I/O field have a parent-child relationship. Because we are dealing with a reference, only the object name of the tag is copied.

Insert objects

Objects copied into the clipboard may be inserted into another device in the same project or into a different project. If an object with the same name exists in the target project, the copied object will be saved under the same name with a consecutive number. If several objects with the same name and consecutive number exist, the next available number will then be used. Parent objects as well as child objects will be inserted. Only the object name of the reference will be inserted. If a reference of the same name with valid properties exists in the target object, the existing reference will then be connected to the copied object.

Replacing objects

Existing objects in the target project may be replaced by the copied objects in the clipboard. The complete contents of the copied objects will be compared with the contents of the existing objects in the target project, when flat copying. Existing objects with the same name will be replaced. Containing child objects will also be replaced. References are not copied during flat copy. Only the object name of the reference will be inserted. If a reference of the same name with valid properties exists in the target object, the existing reference will then be connected to the copied object.

3.6.3 Copy

Menu command "Copy"

Using the menu command "Copy" you are creating an extensive copy of an object. With an extensive copy, the references as well as the objects with a parent-child relationship will be copied.

Example of a flat copy:

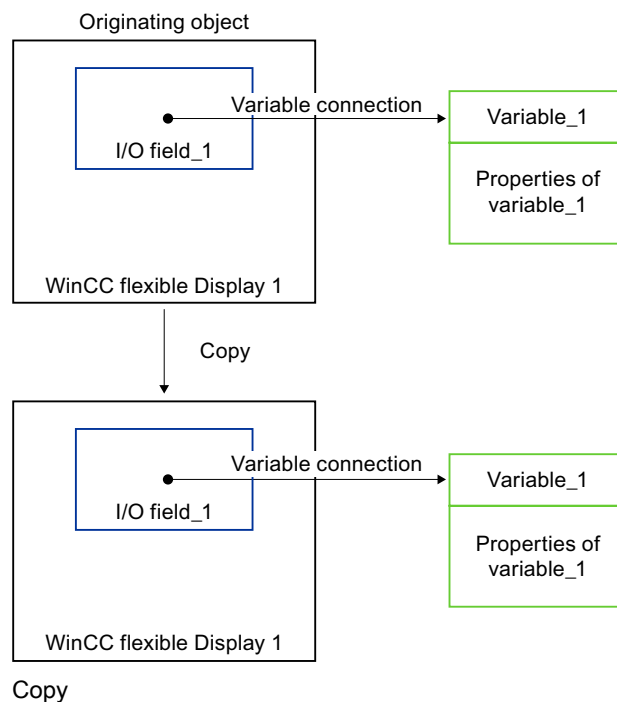

The WinCC flexible screen contains an I/O field with a tag attach. When copying using the menu command "Copy", the screen, the I/O field and the tag including its properties will be copied.

Insert objects

Objects copied into the clipboard may be inserted into another device in the same project or into a different project. If an object with the same name exists in the target project, the copied object will be saved under the same name with a consecutive number. If several objects with the same name and consecutive number exist, the next available number will then be used. Parent objects, child objects and references will be inserted. If the copy contains references, the system will compare these references with existing references in the target object. If the existing references have suitable features, they will be connected to the inserted objects. If a reference is not suitable, the copied reference will then be inserted.

Replacing objects

Existing objects in the target project may be replaced by the copied objects in the clipboard. When doing an extensive copy, the complete contents of the copied objects will be compared with the contents of the existing objects in the target project. Existing objects with the same name will be replaced. Containing child objects will also be replaced. If the copy contains references, the system will compare these references with existing references in the target object. A dialog opens by determining which existing references need to be replaced. In the dialog select the type of references which need to be replaced

3.6.4 Replace

Application

You can use the "Replace" command in WinCC flexible to integrate new or updated objects into your WinCC flexible project, for example, objects of a ProAgent project.

With the "Replace" command, objects are accepted or updated from other projects. The objects can be activated without resolving the project structure.

Objects can be individual objects, e.g. screens, or the complete configuration of an HMI device.

Process

Using the menu command "Copy" you are creating an extensive copy of an object. During copying, both the references as well as the objects with a parent-child relationship are copied. In order to insert the copy, use the "Replace" menu command.

The object names are checked to see if an object of the same name already exists in the target project. Existing objects with the same name will be replaced. The child objects contained will also be replaced. The recipe in the target project has 50 entries and the recipe in the source project has 500 entries. If you replace the recipe in the target project, the entries that are not in the target object are set up. In the case of entries that already exist in the target project, the settings are replaced by the settings of the source project.

If the copy contains references, the system will compare these references with existing references in the target object. Via a dialog box you can establish which references you want to replace.

Source project



The tag VAR2 is of a BYTE data type and references the FKTX function.

Target project

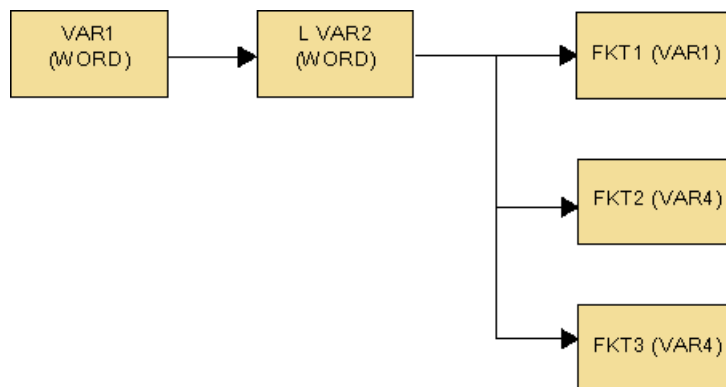

The tag VAR1 has a limit tag VAR2 of WORD data type. The limit tag references the three functions FKTX, FKTX and FKTX.

Result

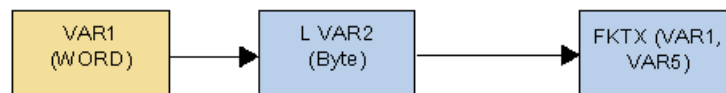

The limit tag VAR2 is replaced by the VAR2 tag from the source project. The references in the target project are not changed by the replacement. The missing FKTX reference is added to the target project. The reference tag VAR5 from the inserted object is also inserted in the target project.

Note

If you insert objects by replacing them, note the following:

- The number of object instances you can insert depends on the HMI device
 - If the target project has less of a function scope than the source project, not all objects will necessarily be accepted
 - If you replace the entire configuration of an HMI device, the process can no longer be reversed. You can however reverse the replacement of individual objects
 - If errors occur when replacing in the target project, these are reported when the project is generated
 - The "Copy" and "Replace" menu commands cannot be used to replace faceplates and their instances. Refer to the "Copying faceplates" for more information
-

3.6.5 Using libraries

Principle

Libraries enable the multiple use of objects. Libraries can be used to save all types of objects from simple graphics up to complex modules.

WinCC flexible provides different libraries for different tasks:

- Shared libraries

A global library is saved as a file in the file system independent of a project (in the installation directory of WinCC flexible by default). Global libraries are available for all projects.

- Project libraries

A project library is saved together with the project data in the database and is only available in the project in which it was created.

It is possible to exchange objects between the two libraries.

Objects in libraries

All objects which can be moved by means of drag-and-drop can be saved in libraries, e.g. graphic objects, screens, alarms and tags.

When an object which has references to other objects is saved in the library, it is possible to select whether the referenced objects should also be saved in the library. A reference object can be a tag, for example, for an I/O field.

Configuration of libraries

The following configuration options are provided for libraries:

- Creating folders to organize the objects
- Changing the display of the library objects

It is possible, for example, to display small icons or library objects without names.

- Multilanguage configuration of library objects

3.6.6 Using faceplates

Principle

Faceplates are groups of preconfigured objects. Faceplates extend the number of screen objects available and reduce the amount of work for configuration. Faceplates are created and edited in the Faceplate Designer.

This editor is used to define the faceplate properties which can be configured when put in use. These properties can be the properties of the objects contained.

In addition, all of the places where a faceplate is used can be managed centrally in the "Faceplate" editor. After changing the faceplate, either all or only selected place where a faceplate is used can be updated.

3.7 Working with the cross-reference

Principle

The "Cross Reference list" editor enables all usage points for specific objects, e.g. tags or screens, to be located and to skip to those points directly.

Cross-reference user interface

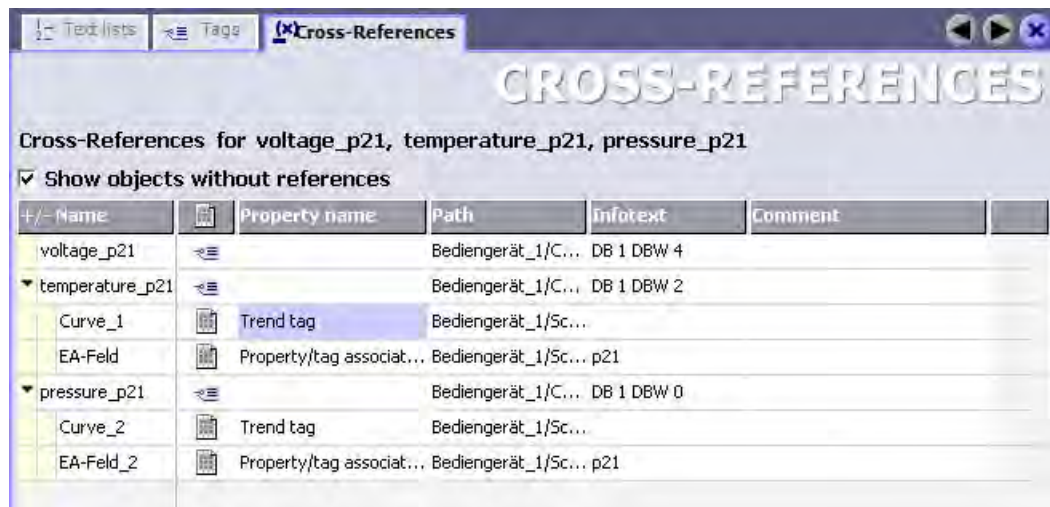

Open the object by double-clicking the icon.

Possible operations in the cross-reference via the shortcut menu

Use the "Go to usage" command to skip directly to the location of usage in the project. Alternatively, double-click the point of usage icon.

It is possible to change the view in the "Cross reference" editor. The following commands are available to change the view:

- Collapse all
The "Collapse all" command is used to hide the list of places of use for all objects.
 - Expand all
The "Expand all" command is used to recall the list of places of use.
- The "Print" command is used to print the cross-reference list.

3.8 Overview of rewire

Introduction

You can change the tag attachment of objects. You use the "Rewire" wizard to assign new tags to, for example, I/O fields of screens. The "Rewire" wizard searches for tags to rewire at the following places:

- In the selected object in the Project view
- In the selected object in the working area

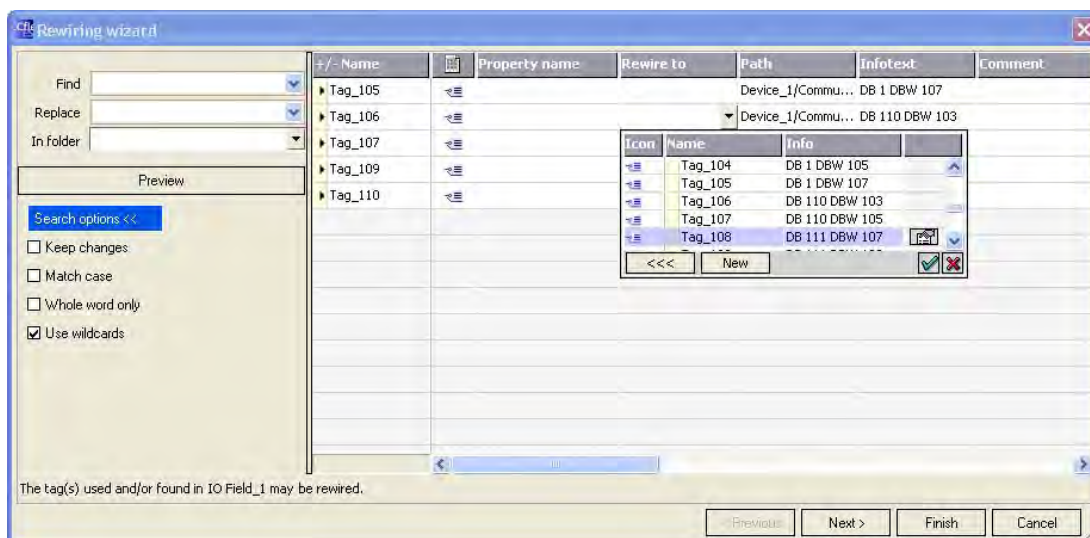

You have the following possibilities of rewiring:

- Individually via the "Rewire" column
- Using the "Find" and "Replace" fields

3.9 Internal project find and replace feature

Principle

WinCC flexible enables character strings and objects to be found and replaced.

- You can find and replace character strings in the workplace: Use the "Find in workplace..." dialog and "Replace in workplace..." dialog in this case.
- You can search for objects in the complete project or in parts of the project. Use the "Find in project" dialog in this case.

3.10 Basic principles on documentation in WinCC flexible

Principle

Use the project documentation to recall an overview of the configuration data.

The project documentation can be provided as follows:

- Displayed on screen
- Output as file, e.g. PDF or HTML
- Output via a printer

If only certain parts of the project data need to be used in the project documentation, select the corresponding objects.

3.11 Consistency check during generation

Introduction

During configuration, the data entered is automatically tested for its plausibility.

Example:

Any tag of data type "Byte" you create may assume values between 0 and 255. Input will be rejected if you attempt to enter a start value higher than 255. You are also shown a message informing you of the valid range of values.

The plausibility test ensures, for example, that value ranges are maintained and incorrect input is indicated during the configuration phase.

Incomplete configurations are not checked during input, for example, an I/O field was not assigned a tag. The assignment is checked in the course of generation. An alarm is output to the output window.

Consistency check during generation

In order to check consistency of the configuration data, start generation by clicking , or by selecting the "Project > Generator > Generate" menu command. The project is created. All faulty points in the project are listed in the Output Window. Via the entry in the output window you can jump directly to the cause of error. Work through the error list from top to bottom.

During generation, it is only the configuration changes that are always regenerated. The size of your storage location increases accordingly if many changes are made to the configuration in the course of engineering. Delete the temporary files of the project to reduce the size of the project storage location, for example, to reduce load on memory resources after you completed the project. Select the "Options > Delete Temporary Files" menu command to reduce the blown up project database to essentials.

The "Delete Temporary Files" menu command deletes all temporary project data.

Run a generation if you want to recover the compiled project file. The entire project is recompiled when you run an initial generation after having delete the temporary data. The "*.fwx" or "*.srt" is completely recreated. Depending on the size of the project, this process can take some time.

You can also select the "Rebuild all..." command to initiate compilation of the entire project.

Rebuild all

Recompile the entire project by executing the "Rebuild all" command before releasing your project to the production process.

It is also advisable to execute a "Rebuild all..." command at suitable intervals to reduce the time required for compiling delta data in current engineering sessions.

Execute a full compilation by selecting the "Project > Compiler > Rebuild all..." menu command.

The "Select HMI devices for generation" dialog opens after you have called the "Rebuild all..." command and if you have configured several HMI devices.

Select the HMI devices to be generated from this dialog. Multiple selection is possible.

3.12 Debugging projects

Testing projects using the simulator

The simulator enables the project to be simulated directly on the configuration computer. You can simulate your projects for all configurable HMI devices. The simulation program is an autarkic tool which is installed alongside with WinCC flexible. The simulator enables you to test the response of the configuration by setting values for tags and area pointers.

Tag values can be simulated via a simulation table or the system communication with a real PLC can be simulated.

Testing projects for Windows CE devices

Note the following information when simulating a project for a Windows CE HMI device: The simulator may generate Runtime error messages if the project contains scripts with VBS objects.

Reason: some VBS objects are dependent on the operating system. The project for the Windows CE HMI device is simulated on a Windows operating system such as Windows XP. In this case the Windows XP script engine is used for simulation. If VBS objects that are only supported by Windows CE are contained in the script, corresponding error messages are displayed.

The online help "VBScript for Windows CE" provides a list of functions which differ from those listed in "VBScript for Windows".

3.13 Transferring projects

3.13.1 Basic Principles of the Transfer Operation

Transfer

A transfer operation refers to the transfer of a complete project file to the HMI devices where the project is to run.

Select the "Project > Compiler > Compile" or the "Project > Compiler > Rebuild all" menu command to check consistency of the project after having completed a configuration.

Note

Rebuild all

Recompile the entire project by executing the "Rebuild all" command before releasing your project to the production process.

It is also advisable to execute a "Rebuild all..." command at suitable intervals to reduce the time required for compiling delta data in current engineering sessions.

Execute a full compilation by selecting the "Project > Compiler > Rebuild all..." menu command.

The "Select HMI devices for generation" dialog opens after you have called the "Rebuild all..." command and if you have configured several HMI devices.

Select the HMI devices to be generated from this dialog. Multiple selection is possible.

After completing the consistency check, the system generates a compiled project file. This project file has the same name assigned to it as the project, however with the extension "*.fwx". Transfer the compiled project file to the configured HMI devices.

Note

Because of the diagnostics messages, the fwx file can be fairly large. If the size of the fwx file is preventing you from transferring this file to the HMI device, you should disable the diagnostics messages in the alarm settings.

The HMI devices must be connected to the configuration computer to transfer the project data. If the HMI device is a PC, it is also possible to perform the transfer operation using data media such as diskettes.

Compile the project again if the *.pwx is not found and you receive an error message while transferring the data.

Basic procedure

1. Enter the transfer settings for the individual HMI devices in your WinCC flexible project.
2. Enter the transfer mode on the HMI device where the project is to be transferred.
3. Transfer the compiled project file from the configuration computer to the HMI devices.
The project file is transferred to all HMI devices for which the respective check box is selected in the transfer settings.

Transfer mode

The HMI device must be in "transfer mode" for the transfer operation. Depending on the type of HMI device, transfer mode is enabled as follows:

- Windows CE systems

The HMI device starts up automatically in transfer mode when the device is commissioned the first time.

The HMI device switches automatically to transfer mode at the start of each additional transfer operation if this transfer option is enabled on the configuration menu of the HMI device.

If not, restart the HMI device and call the transfer applet on the Start menu, or configure the "Change Operating Mode" system function in your project.

- PCs

If the HMI device is a PC that does not yet contain a project, you must enable the transfer mode in the "RT Loader" manually before the first transfer operation.

Refer to your manual for more detailed instructions on setting the transfer mode on the HMI device.

Note

Transferring operating systems with MP 377 on PROFIBUS

Due to the size of the image and the baud rates available at PROFIBUS, an image transfer at the MP 377 using PROFIBUS can take up to an hour.

Transfer operating systems or images via USB or Ethernet.

HMI device version

When transferring a project onto the operator device, the system checks if the configured operating system version corresponds with the version on the HMI device. If the system finds different versions the transfer is aborted and a message is displayed. You have following possibilities if the version of the operating system in the WinCC flexible project and on the HMI device are different:

- Update the operating system on the HMI device.

You can find further information in chapter "Operating System Transfer".

3.13.2 Back transfer of projects

Introduction

When transferring, you can transfer the compressed source data file along with the compiled project file to the HMI device. This source data file is required for the project to be back transferred from the HMI device to a configuration computer. The upload of integrated projects is not supported.

Use for back transfer

Normally, only the executable project is transferred to the HMI device during a transfer operation. The original project data remain on the configuration device and are thus available to develop the project further in future or for error analysis.

However, on Windows CE devices with an external storage medium and on PCs, you can store not only the compiled project file but also the compressed source data file for the project. This data file can be used at a later time to recover the project from the HMI device or device by back transferring the source data file to a configuration computer.

Advantage:

The back transfer operation enables you to subsequently perform analyses and make changes to an existing project even if the original configuration device is not available or the source file (*.hmi) for the project is no longer available on the configuration device.

Note

You can also use WinCC flexible to transfer the source data file of a ProTool project back from the HMI device onto a configuration computer. You can then perform a migration of the ProTool project to a WinCC flexible project.

The source data of a ProTool project which was configured for an operating device not supported by WinCC flexible must be transferred back to a configuration computer with ProTool. Save the ProTool project. Then execute a migration using WinCC flexible.

Requirements for back transfer

- The source data file can only be transferred to the HMI device as part of the transfer operation for the compiled project file. The source data file is transferred along with the compiled project file to the HMI device if the "Enable back transfer" check box is selected in the transfer settings for the respective HMI device.
- There must be sufficient memory available on the HMI device to store the compressed source data file. If the source data file for the back transfer operation is provided by a Windows CE device, this device must have an external memory card. If the HMI device does not have a memory card or if there is insufficient memory space, the transfer is terminated. However, the compiled project file is transferred in its entirety beforehand so that runtime can be started with the transferred project data.

If the source data of a large project should be stored for back transfer and an Ethernet connection is available to the operating device, you can select a network drive as the storage location rather than the memory card of the operating device. This avoids problems with the storage location.

- If there is no project opened in WinCC flexible, you must select the HMI device on which the source data file for the back transfer operation is located and the loading method in the "Communication settings" dialog prior to carrying out the back transfer operation.

If a project is open in WinCC flexible, the back transfer operation takes place from each selected HMI device. In this case, the transfer mode selected for this HMI device in the "Transfer Settings" dialog in WinCC flexible is applied.

Transfer and back transfer

When a source file is included in the transfer operation, the project is compressed from the source format (*.hmi) and transferred as a *.pdz file to the external storage medium of the HMI device or directly to the PC.

In the case of a back transfer operation, the *.pdz file is saved on the configuration computer. If a project was open in WinCC flexible during the back transfer, you are prompted to save and close it. Then, the project back transferred is decompressed and opened in WinCC flexible. When saving the project, you must assign a name for the back transferred project.

CAUTION

WinCC flexible cannot check whether the source data file on the operating unit actually belongs to the project running on the device. If you have performed a transfer operation in the interim that did not include the source data file, old project data may still be on the HMI device. Under certain circumstances, the data will then no longer match the project that is currently running.

Note

Use the back transfer process preferably for small and medium sized configurations in order to keep transfer times as short as possible.

You have the following options when there are numerous project files: Transfer the project file as a compressed *.arj file onto a CF card, for example, using the backup function of the project manager.

Working with Tags

4.1 Basics

4.1.1 Basics of tags

Introduction

External tags enable the communication (data exchange) between the components of an automation process, e.g. between the HMI device and the PLC.

Principle

An external tag is the image of a defined memory location in the PLC. You have read and write access to this storage location from both the HMI device and the PLC.

Since external tags are the image of a storage location in the PLC, the applicable data types depend on the PLC which is connected to the HMI device.

If you configure in STEP 7 or SIMOTION Scout integrated, you may directly access all tags when creating the external tags, which were created with STEP 7 or SIMOTION Scout during the programming of the PLC.

When working on distributed systems, you can directly access the tags of the other HMI systems using the OPC interface.

Data types

Basic data types are available for all configurations.

In addition, you can also use other data types for external tags which are intended specifically for the PLC to which a connection exists.

A detailed listing of the basic data types and the data types for a connection to S7 controllers can be found under "Data types if connecting to S7". Information about data types which are available for connection to other PLCs can be found in the documentation about the respective communication drivers.

In addition, you can create your own data types by creating structures.

Note

In addition to the external tags, area indicators can be used for communication between HMI device and PLC. You can set up and activate the area indicators in the "Connections" editor. Detailed information about the area indicators can be found under "Communication."

4.1.2 External tags

Introduction

External tags enable the communication (data exchange) between the components of an automation process, e.g. between the HMI device and the PLC.

Principle

An external tag is the image of a defined memory location in the PLC. You have read and write access to this storage location from both the HMI device and the PLC.

Since external tags are the image of a storage location in the PLC, the applicable data types depend on the PLC which is connected to the HMI device.

If you configure integrated in STEP 7 or SIMOTION Scout when creating the external tags, you can directly access all the tags which were created during the programming of the PLC.

Data types

Basic data types are available for all configurations.

In addition, you can also use other data types for external tags which are intended specifically for the PLC to which a connection exists.

A detailed listing of the basic data types and the data types for a connection to S7 controllers can be found under "Data types if connecting to S7". Information about data types which are available for connection to other PLCs can be found in the documentation about the respective communication drivers.

Note

In addition to the external tags, area indicators can be used for communication between HMI device and PLC. You can set up and activate the area indicators in the "Connections" editor. Detailed information about the area indicators can be found under "Communication."

Updating tag values in scripts and functions

Scripts and system functions always fetch the value of an external tag from Runtime memory. At the start of Runtime, the actual value will be read from the PLC and written to Runtime memory. Next, the tag value will be updated to the set cycle time. Scripts and functions first access tag values read from the PLC at the previous scan cycle checkpoint.

4.1.3 Internal Tags

Introduction

Internal tags do not have any connection to the PLC.

Principle

Internal tags are stored in the memory of the HMI device. Therefore, only this HMI device has read and write access to the internal tags. You create internal tags, for example, in order to execute local calculations.

You can use all basic data types for internal tags. A detailed list of the data types can be found under "Basic data types."

4.2 Elements and basic settings

4.2.1 Tag editor

Introduction

In the tag editor, you create and configure tags.

Open

To open the tag editor, create a new tag or edit a tag displayed in the Object window.

As an alternative, you can open the tag editor by double-clicking on the entry "Tags" in the Project window.

Layout

The tag editor displays all tags that are in a folder.

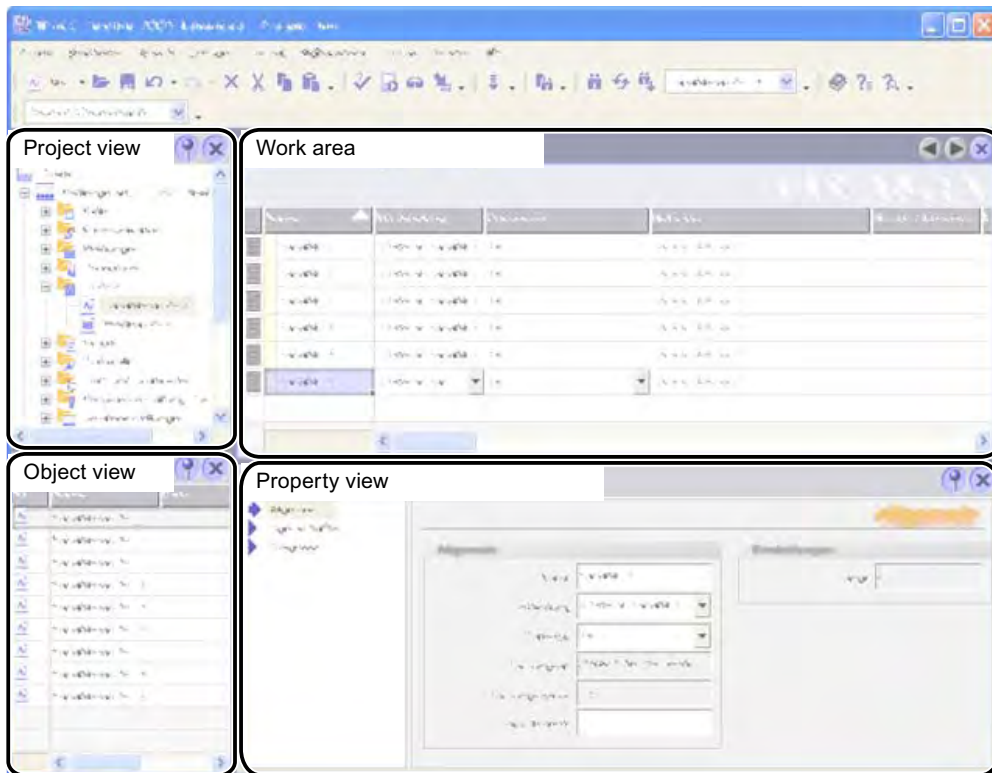

Tag editor

Work area

All tags are displayed in a table in the work area. You can edit the properties of the tags in the table cells. You can sort the table according to the entries in a column by clicking on the column header.

You can configure the selection of columns to suit your needs. Some columns are not available, depending on the HMI device for which you are configuring. The configured column selection will be saved whenever the project is saved. It is linked with the user name that you used when logging into Microsoft Windows.

Property view

Here you configure tags. The property view offers the same information and settings as the work area table.

The property view has a tree structure on the left from which you can select the various property categories. The fields for configuring the selected properties category are shown on the right in the property view.

4.2.2 Basic Settings for Tags and Arrays

Introduction

You can configure the properties of tags and array elements in the tabular editors and also in the corresponding property view.

The respective property view offers the same information and settings as the tag editor.

Structure of the property view

All property views have a tree structure on the left from which you can select the various property categories. The fields for configuring the currently selected properties category are shown on the right in the properties view.

Property view for tags

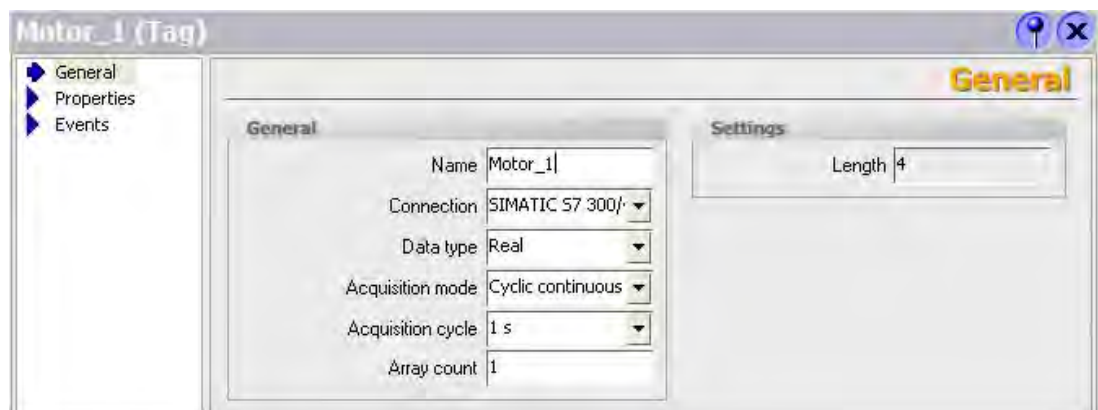

You can configure the following properties of the selected tag in the properties view of tags:

Entry in the tree structure	Fields
"General"	"Name" "Connection" "Data type" "Acquisition type" "Acquisition cycle" "Array count" "Length"
"Properties"	
"Addressing" (for external tags only)	"Icon" (in integrated configuration only) "Area" "DB" "DBW"
"Limits"	"Hi limit - disabled" "Hi limit constant" "Upper limit - tag" "Lo limit - disabled" "Lo limit constant" "Lower limit - tag" Limit check Generate alarms
"LinearScaling" (for external tags only)	"PLC end value" "PLC start value" "HMI device - end value" "HMI device - start value"
"Basic settings"	"Update code" "Continuous update"
"Comment"	Text field for entering the comment
"Multiplexing"	Activating and deactivating indirect addressing
"Logging"	"Data log" "Type of sampling" "Logging cycle"
"Logging limits"	"Upper limit constant" "Upper limit tag" "Upper limit - no limit value" "Lower limit constant" "Lower limit tag" "Lower limit - no limit value"
"Events"	
"Hi limit exceeded"	List of functions that will be processed if the hi limit is exceeded

Entry in the tree structure	Fields
"Value change"	Function list which is processed after the process value changes. Only the "Value change" event is available if a value greater than 1 is entered in the "Array elements" column.
"Lower limit exceeded"	List of functions that will be processed if the value drops below the lower limit

4.3 Working with Tags

4.3.1 Properties of a Tag

Introduction

In WinCC flexible, certain properties can be configured for every tag. The properties determine how you can use the tag in your configuration.

Principle

The following properties can be set for tags:

- "Name"
Every tag has a name which you can choose. Note, however, that the name may only occur once within the tag folder.
- "Connection" to PLC and tag "Logging cycle"
For external tags, you must specify the PLC to which the HMI device is connected since these tags represent memory locations in the PLC. The available data types for a tag and their address in the PLC memory depend on the type of PLC.
Furthermore, you must specify how often the tag should be updated.
- "Data type" and "Length"
The data type of a tag determines which type of values will be stored in a tag, how these are saved internally and the maximum value range that can be held by the tag.
Two simple examples of data types are "Int" for saving integers or "String" for saving character strings. You can input leading zeros in values for tags of data type "Integer".
For text tags of the type "String" or "StringChar", you can also set the "Length" of the tag in bytes. For all other data types, the value of "Length" is fixed.
- "Array count"
You can assemble tags from a number of the same type of array elements. Array elements are saved in consecutive memory locations.
Array tags are primarily used when working with larger quantities of the same form of data, e.g. for a curve buffer or in the definition of a recipe.

- "Comment"
You can enter a comment for each tag to provide for a more exact documentation of your project.
- "Limits"
You can specify a value range with an upper and lower limit range for each tag. If the process value, which should be stored in the tag, enters one of the limit ranges, alarm messages can be sent. If the process value lies outside the value range, a function list for sending messages can be processed.
- "Start value"
You can configure a start value for every tag. The tag will be set to this value at runtime start. In this manner, you can ensure that the project will begin in a defined state every time it is started.
- "Logging" and "Logging limits"
To ease documentation and later evaluation, data can be stored in different logs.
You can set the frequency and mode of logging.
Furthermore, in WinCC flexible it is possible to limit logging to data that is within or outside specified logging limits.

All properties which were configured when the tag was created can be modified with the object list later where the tag is used.

Example: Create a tag and configure its limit values. Link this tag to an IO field. The limit values which were set when the tag was created can be modified with the object list later when the IO field is configured.

4.3.2 Communication with the PLC using external tags

Introduction

External tags are used to exchange data between an HMI device and PLC.

Principle

An external tag is the image of a defined memory location in the PLC. You have read and write access to this storage location from both the HMI device and the PLC.

The fact that the HMI device can access data on the PLC affects which properties are available when you configure the tags. The configuration possibilities supported by the following tag properties depend on the PLC that is connected to the HMI device:

- "Addressing"
- "Data type"

With linear scaling, you can adjust the value range of external tags to suit the requirements of the configuration.

Addressing

If you create an external tag in WinCC flexible, you must specify the same address as it has in the PLC program. This enables both the HMI device and the PLC to access the same memory location.

Note

When you create the external tag in an integrated configuration environment, you can directly access the icon in the symbol table which was created when the PLC was programmed using STEP 7 or SIMOTION Scout. In this case, you need only select the icon which represents the tag. Further settings will then be made by WinCC flexible in accordance with the PLC program.

Data Type

Since external tags are the image of a defined storage location in the PLC, the available data types depend on the PLC which is connected to the HMI device.

A detailed listing of the basic data types and the data types for a connection to S7 controllers can be found under "Data types if connecting to S7". Information about data types which are available for connection to other PLCs can be found in the documentation about the respective communication drivers.

A change from communications driver A to communications driver B may cause discrepancy in the following special situations:

- The data type is recognized, but the address range cannot be interpreted.
In this case, the default address range of the data type is used.
- No suitable data type is found.
The default data type of the communications driver will be used in such a situation.

Acquisition cycle

The acquisition cycle determines when the HMI device will read the process value of an external tag. Normally, the value is updated at regular intervals as long as the tag is shown in the process screen or is logged. The interval for regular updates is set with the acquisition cycle. You can either choose a default acquisition cycle, or define a user-specific cycle.

An external tag can also be updated independent of the display in the process screen, for example, by triggering a value change for the tag functions. Please note that frequent read operations increase communication load.

Linear scaling

You can configure a linear scaling for numerical data types. The data in a PLC for an external tag can be mapped to a specific value range in the WinCC flexible project.

Example: The user enters length dimensions in centimeters although the controller expects inches. The entered values are automatically converted before they are forwarded to the controller. Using linear scaling, the value range [0 ...100] on the PLC can be mapped to the value range [0 ...254] on the HMI device.

4.3.3 Changing the tag configuration

Introduction

You can change tags at any time to adapt to changes in the project requirements.

Principle

WinCC flexible offers you several possibilities for changing the configuration of tags.

- Tag editor

Use the tag editor to configure tags when you need a tabular overview of multiple tags. In the tag editor, for example, you can compare and adjust the properties of multiple tags or sort the tags by their properties.

- Object list

Use the object list if you want to modify a tag directly at the location where it is used. To do this, click on the "..." button next to the tag that you wish to change in the object list. You can then configure the tag in the Property view.

If you change a tag property and this change causes a conflict with another property, it will be highlighted in color to draw your attention to this fact. This could happen, for example, if you connect the tag with a different PLC which does not support this tag type.

4.3.4 Tag limit values

Introduction

You can define a value range for numerical tags.

Principle

You can specify a value range with an upper and lower limit range for numerical tags.

If the process value of a tag falls into one of the limit ranges, you can have an analog alarm, e.g. a warning, sent.

If the process value exceeds the value range, you can configure this to trigger an analog alarm message or a function list. If the operator enters a value for the tag that is outside the configured value range, the input is rejected and the value will not be entered.

Note

The text of the analog alarm message, which is sent when the limit value is exceeded, can be changed using the analog alarms editor.

Application example

Use the limit values, e.g. to warn the operator in time, if the value of a tag enters a critical range.

4.3.5 Start value of a tag

The value of a tag at the beginning of a project

You can configure a start value for numerical tags. The tag will be preset to this value at runtime start. In this manner, you can ensure that the project begins in a defined state.

In the case of external tags, the start value will be displayed on the HMI device until it is overwritten by the PLC or an operator input.

Application example

You can preset an IO field to a default value. Enter the desired default value as start value for the tag that is linked to the IO field.

4.3.6 Updating the Tag Value in Runtime

Introduction

Tags contain data which change during runtime. Value changes are handled differently at internal and external tags.

Principle

If a start value has been configured for the tag, the tag will be set to this value at runtime start. Tag values change in runtime.

In runtime, you have the following options of changing the tag value:

- by executing a system function, for example, "SetValue."
- by operator input, for example, at an IO box
- A value assignment in a script
- A value change in an external tag in the PLC

Updating the value of external tags

Method for updating the value of an external tag:

- Updating after an acquisition cycle

Normally, tags are updated after an acquisition cycle as long as the tag appears in a picture or is logged. The acquisition cycle determines the update cycle for tag value updates on the HMI. You can either choose a default acquisition cycle, or define a user-specific cycle.

- When the setting "Cyclic continuous" is activated

If this setting is activated, the tag will be updated in runtime, even if it is not found in the currently open screen. This function is set, for example, for tags which are configured to trigger a function list in the event of a change in their value.

Only use the "Cyclic continuous" setting for tags that must truly be updated. Frequent read operations increase communication load.

4.3.7 Data logging

Introduction

In runtime, tag values can be stored in logs for later evaluation. For the logging of a tag, you must specify the log in which the values are to be stored, how often this should happen and whether only the tag values in a specific value range are to be saved.

Note

The main purpose of data logging is to log the values of external tags. However, you can also log the values of internal tags.

Principle

Several steps are involved in data logging:

- Creating and configuring data logs

When creating a data log, you must define the following:

- General settings, e.g. name, size, storage location
- Behavior at runtime start
- Behavior when the log is full

- Configuring the logging of tags

You can specify a data log for every tag. This log records the values of the tags in runtime and other information, e.g. the time the value was logged.

Furthermore, you can define when and how often the value of the tag should be logged. To perform the latter, you have the following options:

- "On request":
The tag values are logged by calling the "LogTag" system function.
- "On change":
The tag values are logged, as soon as the operator device detects a change of value in the tag.
- "Cyclic continuous":
The tag values are logged at regular intervals. In addition to the standard cycles available in WinCC flexible, you can add cycles of your own, which are based on the standard cycles.

Furthermore, you can restrict the logging to those values that are within or outside of a tolerance band. In this manner, you can distribute tag values specifically to different logs for separate analysis later.

If you log a tag "upon request", this tag should not be logged in a sequence log in which the tags "cyclically continued" or "if changed" are logged. If the logging upon request occurs only rarely, then the sequence log is, for example, completed with cyclically logged values and the next sequence log is set up. If there is then an access to the tag that has been logged upon request, the tag cannot be shown as in runtime the current sequence log is being accessed. As a remedy, for rarely logged tags, set up a separate tag log.

- Processing logged tag values further

The logged process tag values can be evaluated directly in your WinCC flexible project, e.g. in a trend view, or with another application, e.g. Excel.

4.3.8 Linear scaling a tag

Introduction

Numeric data types can be processed with linear scaling. The data in a PLC for an external tag can be mapped to a specific value range in the WinCC flexible project.

Principle

To apply linear scaling to a tag, you must specify one value range on the HMI device and one on the PLC. The value ranges will be mapped to each other linearly.

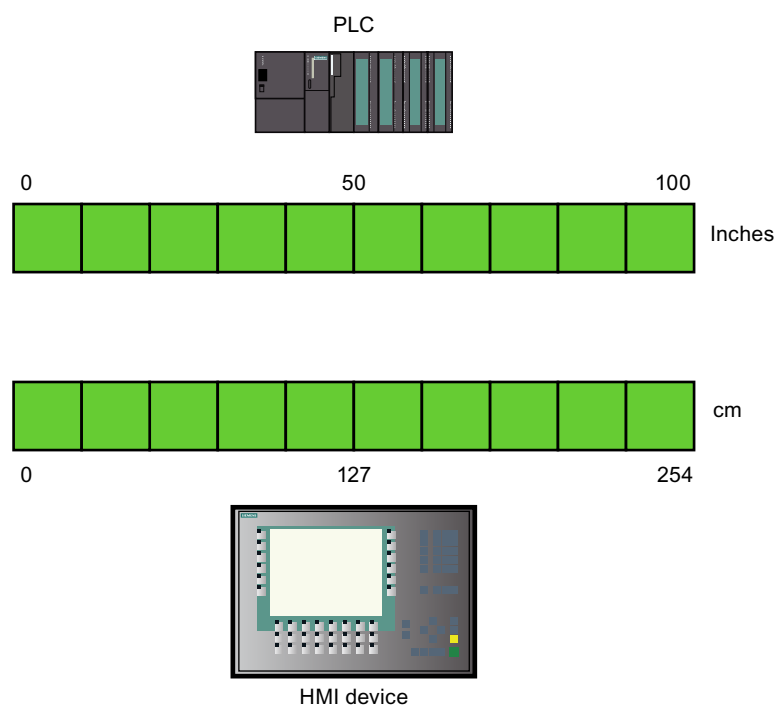

As soon as data from the HMI device is written to an external tag, it will be automatically mapped to the value range of the PLC. As soon as data from the HMI device is read from the external tag, a corresponding transformation will be performed in the other direction.

Note

You can also use the system functions "LinearScaling" and "InverseLinearScaling" to automatically convert process values.

Application example

The user enters length dimensions in centimeters although the controller expects inches. The entered values are automatically converted before they are forwarded to the controller. Using linear scaling, the value range [0 ... 100] on the PLC can be mapped to the value range [0 ... 254] on the HMI device.

4.3.9 Indirect addressing of tags

Principle

In multiplexes, a type of indirect addressing, the tag used is first determined at runtime. A list of tags is defined for the multiplex tags. The relevant tag is selected from the list of tags in runtime. The selection of the tag depends on the value of the index tag.

In runtime, the system first reads the value of the index tag. Then the tag which is specified in the corresponding place in the tag list is accessed.

Application example

Using indirect addressing, you could configure the following scenario:

The operator selects one of several machines from a selection list. Depending on the operator's selection, data from the selected machine will be displayed in an output field.

To configure such a scenario, configure the index tag for a symbolic IO field. You configure the multiplex tag for an IO field. Configure the tag list of the multiplex tag to reflect the structure of the selection list.

If the operator selects another machine, the value of the index tag will change. The selection field will then display the content of the tag which is pointed to in the tag list (in the multiplex tag) by the new index value.

4.4 Array basics

Definition

Array data of a uniform data type is successively arranged and is addressed within the address space to allow access to these data by means of an index. The array elements are addressed by means of an integer index starting at "0". Each array element is assigned the same properties which are configured at the array tag.



System	Name	Info
	ArrayTag	DB 1 DBD 0
	ArrayTag[0]	DB 1 DBD 0
	ArrayTag[1]	DB 1 DBD 4
	ArrayTag[2]	DB 1 DBD 8
	ArrayTag[3]	DB 1 DBD 12
	ArrayTag[4]	DB 1 DBD 16

	ArrayTag[96]	DB 1 DBD 384
	ArrayTag[97]	DB 1 DBD 388
	ArrayTag[98]	DB 1 DBD 392
	ArrayTag[99]	DB 1 DBD 396

Object view

Advantages

Multiple array elements of the same properties can be addressed by a single array tag. You can then use each array element as any other tag in your configuration. There are certain limitations:

- Not all HMI devices support array tags.

Application examples

Array tags can be used in the following situations:

- To group process values in profile trends: You map process values to trends which are acquired at different points in time, for example.
- To access specific values which are grouped in trends: You output all values of the profile trend by stepping up the index tag, for example.
- To configure discrete alarms with successive bit number.
- To save machine data records to a single tag.

License rule for runtime

An array is counted in WinCC flexible Runtime as one PowerTag, regardless of the number of array elements.

Special features

 WARNING
Increased system load and performance losses Read or write access to a single array element always includes read or write access to all array elements of the array tag. Transfer of the data of large arrays from and to the PLC usually takes longer compared to the transfer of a basic data type. This may cause communication overload and disruption as a result.

Example:

- An array tag which consists of 100 array elements of data type "Real" was configured.
- If an array element with a length of four bytes changes, 100 x 4 bytes are written to the PLC.

Use in scripts

For the same reasons of performance you should always use internal temporary arrays to change arrays.

1. Copy the PLC array to the internal array at the start of the script.
2. Load on data transfer to the PLC is avoided while the script processes the internal array.

 CAUTION
Data inconsistency at array tags The entire array is read at the time t1 if an array element changes. The modified array element is replaced in the array. The array is written back to the PLC at the time t3 > t1. If the array has changed again within the time t2, the changed value t2 is overwritten with time value t1 at the time t3. Array data is therefore inconsistent at the time t3. You should always prevent the HMI device and the PLC from concurrently writing values to the same array tag. Use synchronous transfer of recipe data records to synchronize an array tag with the PLC.

4.5 Examples of arrays

Introduction

Array tags group multiple tags to form a data structure which, for example, consists of 100 array elements. Array elements are tags you can use anywhere in your configuration. Array tags can also be used at the following locations:

- In the "Alarms" editor
- In the "Recipes" editor
- For address multiplexing
- In the trend view

Examples

You can configure an array tag with the corresponding number of array elements to handle multiple tags of the same data type and to save engineering time.

1. The array elements can be accessed indirectly by means of a multiplex index tag, for example.
2. Use these index tags to operate and monitor the array elements.
3. Using an array tag you create multiple recipe elements which are interconnected automatically with the corresponding array elements.
4. Synchronize the array tag with the PLC by means of the recipe.

4.6 Cycle basics

Introduction

Cycles are used to control project sequences that are run at regular intervals. Common applications are the acquisition cycle, the logging cycle and the update cycle. Besides the cycles predefined in WinCC flexible, you can also define your own cycles.

Principle

In runtime, actions that are performed at regular intervals are controlled by cycles. Typical applications for cycles include the acquisition of external tags, the logging of data and the updating of screens.

- Acquisition cycle

The acquisition cycle determines when the HMI device will read the process value of an external tag from the PLC. Set the acquisition cycle to suit the rate of change of the process values. The temperature of an oven, for example, changes much more slowly than the speed of an electrical drive.

If the acquisition cycle is set too low, it will strongly increase the communication load on the process.

- Logging cycle

The logging cycle determines when data will be saved in the log database. The logging cycle is always an integer multiple of the acquisition cycle.

- Update cycle

The update cycle determines how often a screen will be refreshed.

The smallest possible value for the cycle depends on the HMI device that will be used in your project. For most HMIs, this value is 100 ms. The values of all other cycles are always an integer multiple of the smallest value.

If the standard cycles predefined in WinCC flexible do not satisfy the requirements of your project, it is possible to define your own cycles. These custom cycles must, however, be based on the standard cycles.

Application example

Use cycles, for example, to log your process at regular intervals or to provide reminders of the maintenance intervals.

4.7 Working with structures

4.7.1 Structure basics

Introduction

With structures you bundle a number of different tags that form one logical unit. Structures are project global data and apply to all HMI devices within the entire project.

Principle

For instance, the various states of a valve can be replicated by means of four tags.

Name	Connection	Data type	Array count
valve_activated	<Internal tag>	Byte	1
valve_closed	<Internal tag>	Byte	1
valve_defect	<Internal tag>	Byte	1
valve_opened	<Internal tag>	Byte	1

With a structure, the different states can be united. Within the structure you set up a structure element for each tag. To the structure element you assign the properties that the tag created from it should include, e.g. data type.

Name: PLC: <Internal structure>

Name	Data type	Array count	Offset
activated	Byte	1	0
opened	Byte	1	2
closed	Byte	1	4
defect	Byte	1	6

You assign the generated structure a tag or a dynamic property of the faceplate as a data type. The structures that can be selected are displayed in the "Data type" list box following the standard data types.

Note

You can work with structures and tags of a structure data type only in the faceplates.

License regulation in Runtime

If you use external tags of the structure data type in a faceplate instance, in WinCC flexible Runtime, each structure element is counted as a tag.

Example

You have created two screens in the Screen Editor: Screen_1 and screen_2

3 faceplate instances are inserted in Screen_1 and 4 faceplate instances in Screen_2. Each faceplate instance is linked with an external tag of a structure data type. The structure contains 10 structure elements.

Screen 1: 3 faceplate instances * 10 structure elements corresponds to 30 external tags = 30 PowerTags.

Screen 2: 4 faceplate instances * 10 structure elements corresponds to 40 external tags = 40 PowerTags.

In WinCC flexible Runtime, 70 PowerTags are counted for both screens. This also applies to the structure elements that are not required.

4.7.2 Structures Editor

Introduction

You create the structures and structure elements in the Structures Editor. Structures are project global data and apply to all HMI devices within the entire project.

Open

Double-click on "Add structure" in the "Structures" group of the project view. A new structure is generated in the project view and the work area is opened with a new structure.

Structure

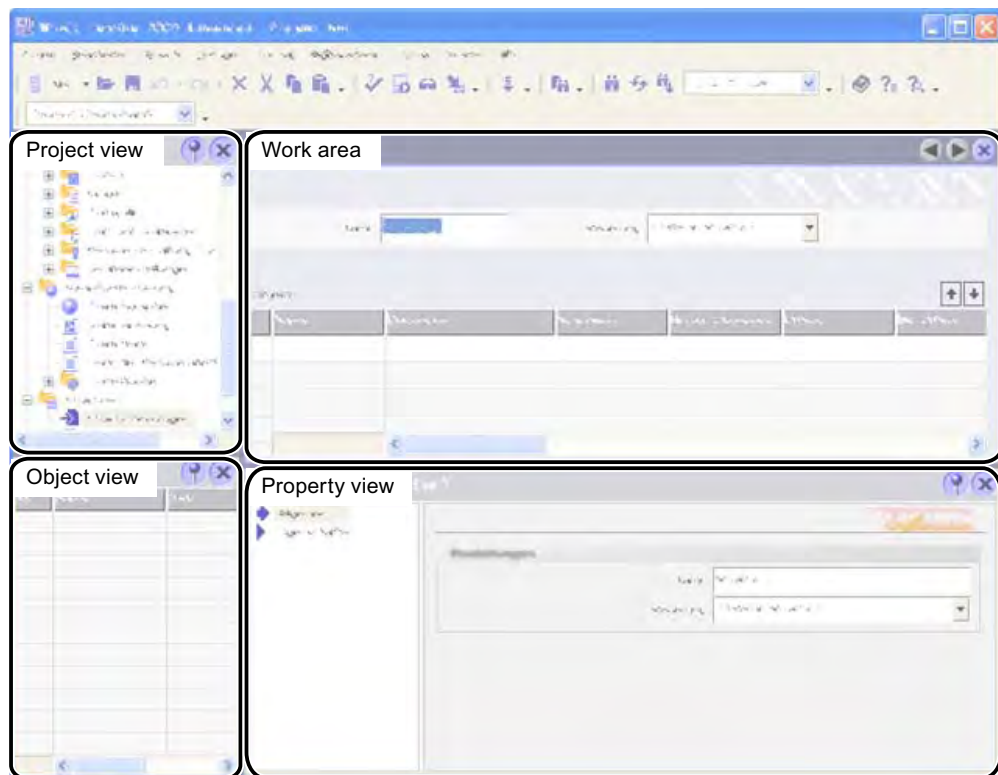

Work area

The structure elements are displayed in table form in the work area. You use the table cells to edit the properties of the structure elements. To sort the table by its column entries, simply click the column header.

You can show and hide the table columns. To do this, you activate or deactivate the entries in the pop-up menu of the table header.

Properties view

Configure the structure elements in the Properties view. The Properties view offers the same information and settings as the work area table.

4.7.3 Managing structures

Renaming structures

1. Under "Structures" In the project view select the structure that you wish to rename.
2. Select "Rename" from the shortcut menu.
3. Type in a new name.
4. Press <Enter>.

As an option, use the <F2> function key to rename the structure.

Copying and inserting structures

1. Under "Structures" In the project view select the structure you wish to copy.
2. Click the "Copy" icon on the toolbar.
3. Click the "Paste" icon on the toolbar.

As an option, use the "Copy" and "Paste" commands of the "Edit" menu or of the shortcut menu. These functions are also available by means of the <CTRL+C> and <CTRL+V> keystrokes.

A copy of the original structure is generated in the project view and inserted in the work area. The name of the structure is provided with a consecutive number.

Deleting structures

When deleting a structure the structure elements contained within it are also deleted.

1. Under "Structures" In the project view select the structure you wish to delete.
2. Click the "Delete" icon on the toolbar. If the structure to be deleted is being used in a faceplate, then a dialog appears. The dialog asks if you really want to delete the structure.

As an option, use the "Delete" command in the "Edit" menu or of the pop-up menu. You can also use the key.

When deleting a structure the structure elements contained within it are also deleted. The entry remains in the allocated tag. In the Tag Editor, a colored background denotes that by deleting a contradiction in the data type has occurred. Change the data type in the Tag Editor.

Renaming structure elements

1. Under "Structures" In the project view select the required structure.
The structure is opened in the Structures Editor.
2. Select the structure element that is to be renamed.
3. Select the "Rename" command from the shortcut menu.
4. Type in a new name.
5. Press <Enter>.

You can also use the <F2> function key to rename the structure.

Editing structure elements

1. Double-click the required structure in the "Structures" area of the project view.
The structure is opened in the Structures editor.
2. Highlight the structure element that is to be edited.
3. Change the properties of the structure element, e.g. the data type.

If you wish to change the properties of a structure tag, then you must always change the properties of the structure element.

Copying and inserting structure elements

1. Double-click the required structure in the "Structures" area of the project view.
The structure is opened in the Structures editor.
2. Highlight the structure element that is to be copied.
3. Click the "Copy" toolbar icon.
4. Click the "Paste" toolbar icon.

You can also use the "Copy" and "Paste" commands of the "Edit" or shortcut menu. You can also use the <CTRL+C> and <CTRL+V> keystrokes.

A copy of the original structure element is inserted in the work area. The name of the structure element is provided with a consecutive number.

Deleting structure elements

1. Double-click the required structure in the "Structures" area of the project view.
The structure is opened in the Structures editor.
2. Highlight the structure element that is to be deleted.
3. Click the "Delete" icon on the toolbar.

You can also use the "Delete" command from the "Edit" or shortcut menu. The key can also be used.

4.8 Importing Tags

4.8.1 Importing and exporting tags

Introduction

WinCC flexible offers you the option of exporting tag data from a project and importing this data in another project. This import and export function reduces the workload. Instead of creating new tags, you use the tags that you have already created in earlier project or that you have exported from PLC programs.

Exporting tags

During export, the tag information is written to a CSV file. In addition to the tag name and data type, all other properties of the tags are exported as well.

Importing Tags

Two files are needed for a complete import of tag data. One of these files contains the information on interfacing with the control. The other files contain the information from the tag.

First import the file with the interfacing data. When you now come to import the second file, the data types and the PLC memory addresses are checked at the same time. Before beginning the import, you can specify whether or not to overwrite existing connections or tags with the same name.

The tag data can be imported without a file containing the interfacing data. The following examples show the complete import.

Preparing the CSV file for external data sources

Applications are available for preparing the tag data of PLC programs. One application, the Tag Converter, is available on your product DVD at <CD_3\Support\Tag Converter>.

The latest version of this application is available for download from the Internet at the following address: to the download area

Use the Tag Converter to convert data from the following communication drivers:

- Allen-Bradley
- GE FANUC
- Modicon MODBUS
- STEP 7
- Telemecanique

4.8.2 Settings for exporting and importing tags

Introduction

The "CSV Import" dialog is available for importing tags. Make the required settings in this dialog so that the import files can be correctly interpreted.

Note

The menu structure for the import of CSV files has changed with the introduction of WinCC flexible 2008.

Importing Tags into an HMI Device

To open the "CSV Import" dialog, select the required HMI device from the project window and then select the "Import CSV..." shortcut menu command. As an alternative, select the HMI device and then select the "Project > Import/Export > CSV Import" menu command.

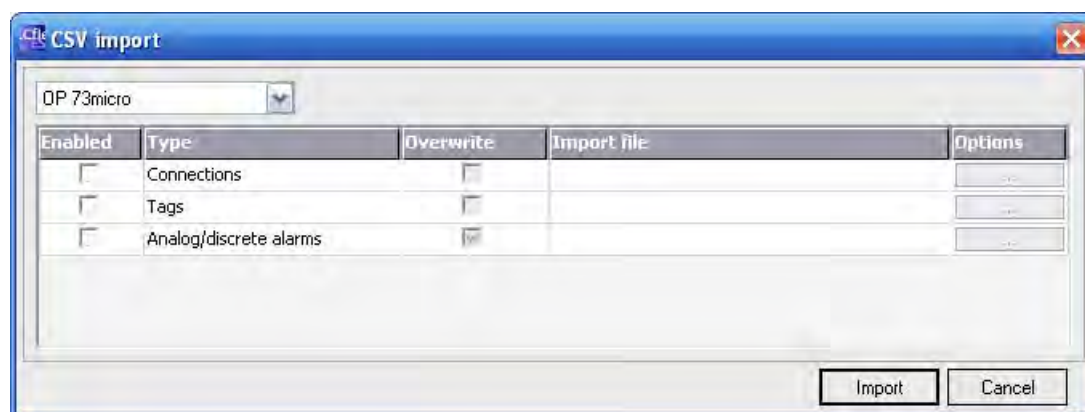

Enter the location of the import files in the "Import file" column, or navigate to the storage location and select the files required. The import files must be in "*.csv" format. The file names are validated before the import begins.

If you enable the "Overwrite" check box, previous connections or tags with the same name will be overwritten during import. If you disable the check box, connections and tags with the same name in WinCC flexible are not imported.

Click the "..." button in the "Options" column to define the import settings. A new dialog box opens.



In the "List separator" field, select a character to be used to separate the individual parameters for connections and tags. Refer to the sections "Format of the Connection Data for the Import" and "Format of the Tag Data for the Import" for more information.

The text qualifier identifies text and strings. The characters enclosed in quotation marks will be interpreted as text. For example, when you import text that includes characters used as control characters for the import, they should be enclosed in quotation marks. The quotation mark is used as text qualifier. A different character cannot be used.

You can specify the separators for decimals and thousands to identify numeric data. Select from the list of characters offered in the respective fields. Quotation marks cannot be used for these separators.

Note

Use different separators for lists, decimal points and thousands. These separators may not be identical.

The "Use folder delimiter" option allows you create a folder tree with the tag names. The folder tree is created in WinCC flexible and the tags saved in the folders. Select the separator for the folder tree in the "Folder delimiter" field.

Example:

The tag name is "Folder1\Tag_01". The folder separator is "\". In WinCC flexible, "Folder1" is created in the project window under "Communication/Tags" and "Tag_01" is saved in it.

4.8.3 Format of the connection data

Introduction

This section describes the format required for the file with connection data used for imports. The connection data file must be in "*.csv" format.

Format of Connection Data

Each connection is on a separate line in the import file. The import file with the connection data must have the following format:

<Connection name><List separator>

<Communication driver name><List separator>

<Comment><Line break (carriage return+line feed)>

Meaning of the entries

List entry	Description
Connection name	Specifies the configured name of a connection. This entry is needed to match up to the corresponding entry in the import file of the tags. The list entry for "Name" cannot be empty. The name cannot contain an apostrophe (').
List separator	The list separator separates the individual entries in the list. You can select the character to be used for the list separator in the dialog for importing. The following characters are offered for use: "Tab", semicolon ";", comma ",", and period ".". Use the selection field to select a character other than that shown, if needed.
Name of the communication driver	Specifies the name of the communication driver used in WinCC flexible. It must exactly match the name used in WinCC flexible. The following names are available: <ul style="list-style-type: none"> • Allen Bradley DF1 • Allen Bradley DH485 • Allen Bradley E/IP C.Logix • GE Fanuc SNP • LG GLOFA-GM • Mitsubishi FX • Mitsubishi protocol 4 • Modicon MODBUS • Modicon MODBUS TCP/IP • Omron Hostlink/Multilink • OPC • SIMATIC S5 AS511 • SIMATIC S5 DP • SIMATIC S7200 • SIMATIC S7300/400 • SIMATIC 500/505 serial • SIMATIC 500/505 DP • SIMOTION • SIMATIC HMI HTTP Protocol • Telemecanique Uni-Telway
Comment	Any comment about the connection. Comments may be up to 256 characters long.

List entry	Description
Line break	The line break (carriage return + line feed) separates the entries for one connection from the entries for the next connection.

Format of the Import File for Connections

An import file for connections has the following format:

connection, "SIMATIC S7 300/400", connection example

A comma, for example, can be used as the list separator. If a list entry is empty, there are two consecutive list separators. When you are finished defining the entries on a line, you do not have to put a list separator at the end of the line.

Note

An example of an import file is available in the "CD_3\Support\Tag Import" folder on your WinCC flexible DVD.

Editing the import file

You can edit the import file in MS Excel or in any text editor.

Start MS Excel and select "Open" from the "File" menu. Select the type of "Text files (*.prn; *.txt; *.csv)" from the "File type" list. Do not open the import file in MS Excel by double-clicking it, because this will corrupt its data structure and prevent its import.

Open the import file in a simple text editor to check its correct data structure.

4.8.4 Format of the tag data

Introduction

This section describes the format required for the file with tag data used for imports. The tag data file must be in "*.csv" format.

Format of tag data

Each tag is on a separate line in the import file. The import file with the tag data must have the following format:

<Tag name><List separator>
<Connection name><List separator>
<Tag address><List separator>
<Data type><List separator>
<Length of tag in bytes><List separator>
<Number of arrays><List separator>
< Acquisition type><List separator>
<Acquisition cycle><List separator>
<High limit><List separator>
<Additional high limit><List separator>
<Additional low limit><List separator>
<Low limit><List separator>
<Linear scaling><List separator>
<Scaling high limit PLC><List separator>
<Scaling low limit PLC><List separator>
<Scaling high limit HMI device><List separator>
<Scaling low limit HMI device><List separator>
<Start value><List separator>
<Update ID><List separator>
<Comment><Line break (carriage return+line feed)>

Meaning of the entries

List entry	Description
Tag name	Specifies the configured name of a tag. You can prefix the tag names with a folder tree you have set with the folder separator character, for example "Foldername1\Foldername2\tagname". If you have enabled the "Use folder delimiter" check box, the folder tree is created when you perform an import into WinCC flexible. The list entry for "Name" cannot be empty. The name cannot contain an apostrophe (').
List separator	The list separator separates the individual entries in the list. You can select the list separators in the import dialog box. The following characters are offered for use: "Tab", semicolon ";", comma ",", and period ".". Use the selection field to select a character other than that shown, if needed.
Connection name	Specifies the configured name of a connection. This entry is needed to match up to the corresponding entry in the import file of the connections. Each external tag should have a valid entry for the name of the connection. If no name is specified for the connection, an internal tag is created.
Tag address	Specifies the tag address in the PLC. The tag address must exactly match the one used in WinCC flexible, for example, "DB 1 DBW 0" and not "DB1, DBW0". The tag address is empty for internal tags.
Data type	Specifies the data type of a tag. The data types allowed depend on the communication driver being used. The following are examples of possible values: Char, Byte, Int, UInt, Long, ULong, Float, Double, Bool, String, DateTime, Word, Dint, DWord, Real, StringChar, Timer, Counter, Date, Date and time, Time of day, ASCII, +/-DEC, DEC, LDEC, +/-LDEC, IEEE, BIN, 4/8/12/16/20/24/28/32 bit Block, +/- Double, +/- int, 16 bit group, short, KF, KH, KM, KY, KG, KS, KC, KT, Bit in D, Bit in W, DF, DH, IEEE-Float, USInt, SInt, UDInt, Dint, time, BCD4, BCD8, etc.. See the "Communication" section of the documentation for additional information on the data types permitted for the various communication drivers.
Length of the tag in bytes	Specifies the length of the tag in bytes. The entry is usually only used for string tags; for other data types it is otherwise empty.
Array number	Defines the number of array elements in a tag. You can define an array with this value. If the entry is empty, WinCC flexible sets the value to "1".
Acquisition trigger mode	Specifies the acquisition trigger mode of a tag. The acquisition trigger mode is represented by numbers. 1 = on demand 2 = cyclic, when used (default value) 3 = cyclic continuous
Acquisition cycle	Specifies the acquisition cycle of a tag. The acquisition cycle must exactly match the one in WinCC flexible. The value is independent on the language, and must be identical in any language. The default value is "1 s". If the acquisition trigger mode of the tag is "on demand", the acquisition cycle is undefined. User-defined acquisition cycles must be created in advance for the file to be imported.
Upper limit High low limit Low low limit Lower limit	The limits can only be set for numeric values. Only constant numeric values can be used as limits, variables cannot. The default value for limits is "No limit". The following conditions apply to limits: "Upper limit" ≥ "High low limit" ≥ "Low low limit" ≥ "Lower limit"

List entry	Description
Linear scaling	Specifies if linear scaling is enabled. The entry can only be used for external tags. Default value is "Disabled". The value for linear scaling can be given as numbers or text. Permitted values are: "false" or "0" for "disabled" "true" or "1" for "enabled"
Upper PLC scaling value Lower PLC scaling value Upper HMI scaling value Lower HMI scaling value	The upper and lower values can only be set for numeric values.
Start value	Specifies the start value of a tag. Default values are: 0 for numerical values, spaces for characters, actual value for time and date.
Update ID	The job number updates the value of a tag with the aid of a function or a job mailbox. The update ID must be unique within an HMI device.
Comment	User-specific tag comment. You can use up to 500 characters.
Line break	The line break (carriage return + line feed) separates the tag entries.

Format of a tag import file

An import file for tags has the following format:

```
"tag","Connection","DB 1 DBD 0","Real",,1,3,"1
min",20,10,2,1,1,100,10,10,1,15.5,33,comment for the tag
```

A comma, for example, can be used as the list separator. If a list entry is empty, there are two consecutive list separators. When you are finished defining the entries on a line, you do not have to put a list separator at the end of the line. The default value is used for a list entry with no value.

Note

An example of an import file is available in the "CD_3\Support\Tag Import" folder on your WinCC flexible DVD.

Editing the import file

You can edit the import file in MS Excel or in any text editor.

Start MS Excel and select "Open" from the "File" menu. Select the type of "Text files (*.prn; *.txt; *.csv)" from the "File type" list. Do not open the import file in MS Excel by double-clicking it, because this will corrupt its data structure and prevent its import.

Open the import file in a simple text editor to check its correct data structure.

CSV import of tags with address multiplexing

Observe the following rules for the CSV import of tags with address multiplexing:

- Start by importing the referenced tag and then import the tag with address multiplexing. Your CSV file data should therefore start with the referenced tags.
- The CSV export file contains the tags in the proper order.
- The referenced tag and the tag with address multiplexing must be in the same folder for the CSV import.

Restrictions

Exporting tag data which contain floating point numbers could lead to misinterpretation of the values when opening the export file in Excel. If you are using the dot "." as decimal point in the export dialog and a tag has a value between 1 and 12 after the decimal point, Excel interprets this value as date entry. To correct or avoid such errors, use a different decimal separator or append zeros to the tag value after the decimal point.

Example:

You have configured a high limit of 20.5 for a tag of data type "Float", and you have selected the point as decimal separator in the export dialog. The tag value "20.5" is exported in tag data. Excel interprets this value as the date entry 20th of May when you open the CSV file.

Remedy:

Set the comma as decimal separator, for example. You could also extend the tag value to 20,50 in this example.

Creating Screens

5.1 Basics

5.1.1 Screen Basics

Introduction

In WinCC flexible, you create screens which an operator can use to control and monitor machines and plants. When you create your screens, the object templates included support you in visualizing processes, creating images of your plant, and defining process values.

Application example

The figure shows a screen which was created in WinCC flexible. With the help of this screen, the operator can operate and monitor the mixing unit of a fruit juice manufacturing system. Fruit juice base is supplied from various tanks to a mixing unit. The screen indicates the filling levels of the tanks and of the mixer. The screen also contains control elements for the valve units and for the mixer motor.

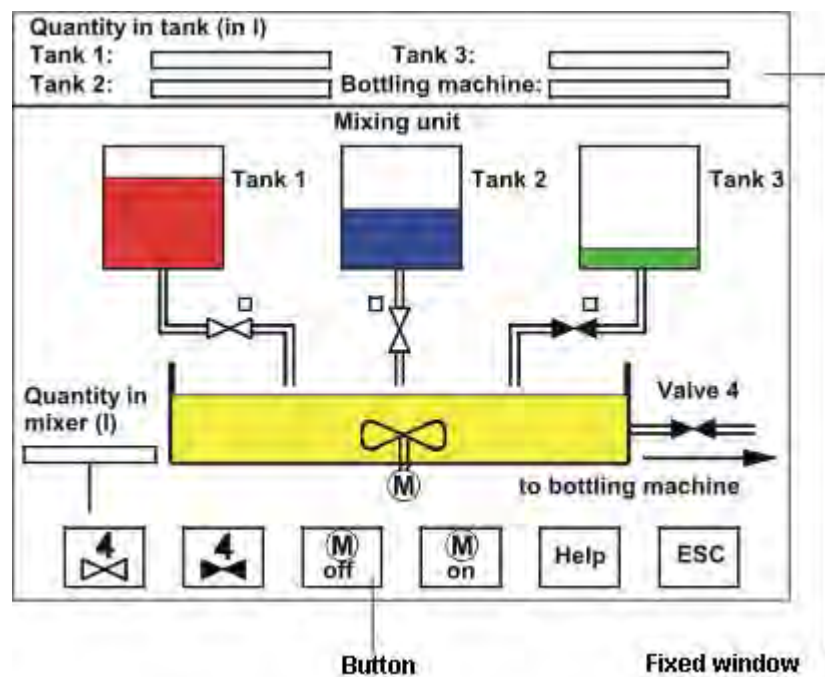

Screen design

Insert an object you need to represent a process into your screen. Configure the object to correspond to the requirements of your process.

A screen may consist of static and dynamic elements.

- Static elements such as text or graphic objects do not change their status in runtime. The tank labels shown in this example of a mixing unit are such static elements.
- Dynamic elements change their status based on the process. Visual current process values as follows:
 - From the memory of the PLC
 - From the memory of the HMI device in the form of alphanumeric displays, trends and bars.

Input fields on the HMI device are also considered dynamic objects. The filling level values of the tanks in our example of a mixing plant are also dynamic objects.

Process values and operator inputs are exchanged between the controller and the HMI device via tags.

Screen properties

The screen layout is determined by the features of the HMI device you are configuring. It corresponds with the layout of the user interface of this device. If the set HMI device has function keys, then, for example, the screen shows these function keys. Other properties such as the screen resolution, fonts and colors are also determined by the characteristics of the selected HMI.

Function keys

A function key is a key on the HMI device. You can assign one or several functions in WinCC flexible. These functions are triggered when the operator presses the relevant key on the HMI device.

A function key can be assigned global or local functions.

- Global function keys always trigger the same action, regardless of the currently displayed screen.
- Function keys with local assignment trigger different actions, based on the currently displayed screen on the operator station. This assignment applies only to the screen in which you have defined the function key.

Navigation

In order for the operator to be able to call a screen in Runtime, you must integrate each configured screen in the operating process. You have various options of configuring these functions:

- Use the "Screen Navigation" editor to define the screen structure and configure the entire screen navigation system.
- You use the "Screen" editor to configure buttons and function keys for calling other screens.

5.1.2 HMI-based dependency of screens

Introduction

The functions of the HMI device determine project visualization in WinCC flexible and the functional scope of the editors.

While creating the project, select the corresponding HMI device for the project. The project view can be used to change the type of HMI device or add further ones.

The following screen properties are determined by the functions of the selected HMI:

- Layout
- Screen resolution
- Color depth
- Fonts
- Objects available

Device layout

The device layout of a screen forms the image of the HMI device in your configuration. The device layout of the screen shows all the function keys available on the HMI device, for example.

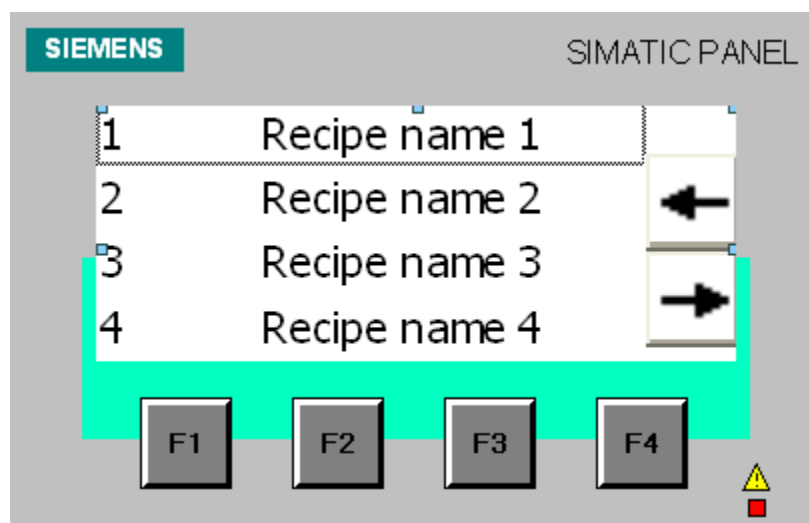

Screen resolution

The screen resolution is determined by the different display dimensions of the various operator panels. The screen resolution can only be influenced when "WinCC flexible RT" has been configured for the PC.

Color depth

You can assign colors to the screen objects. The range of colors is determined by the color depth supported on your selected HMI device.

Fonts

In all screen objects containing static or dynamic text, you can customize the appearance of the texts. You could, for example, identify the priority of individual texts within a screen. Select the font, font style and size, and set additional effects such as underscoring, for example.

Which fonts are available depends on the selected HMI device. The selected font determines which font properties are available.

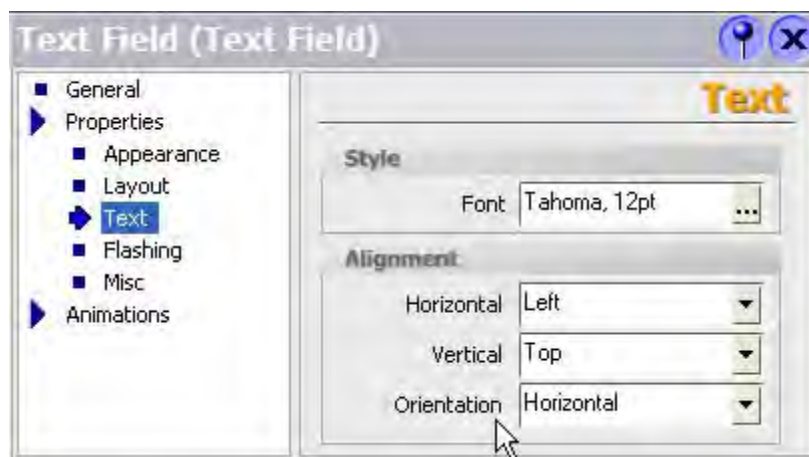

Your text format, for example, the font style (bold, italic etc.) and effects (strikeout, underline), always applies to all of the text in a screen object. That is, you can display the complete title in bold format, but not its individual characters or words, for example.

Objects available

Some of the screen objects can not be configured globally for all HMI devices. These screen objects are grayed out in the Toolbox view and cannot be selected. For a TP 170 touch panel unit you can not configure any buttons, for example.

5.1.3 "Screens" Editor

Introduction

You configure your screens in the "Screens" editor. This editor is formed by the combination of a graphic programming software and a process visualization tool. You open the "Screens" editor from the project view.

Open

Double-click "Add screen" in the "Screens" group of the project view.

The work area opens with a new screen.

Layout

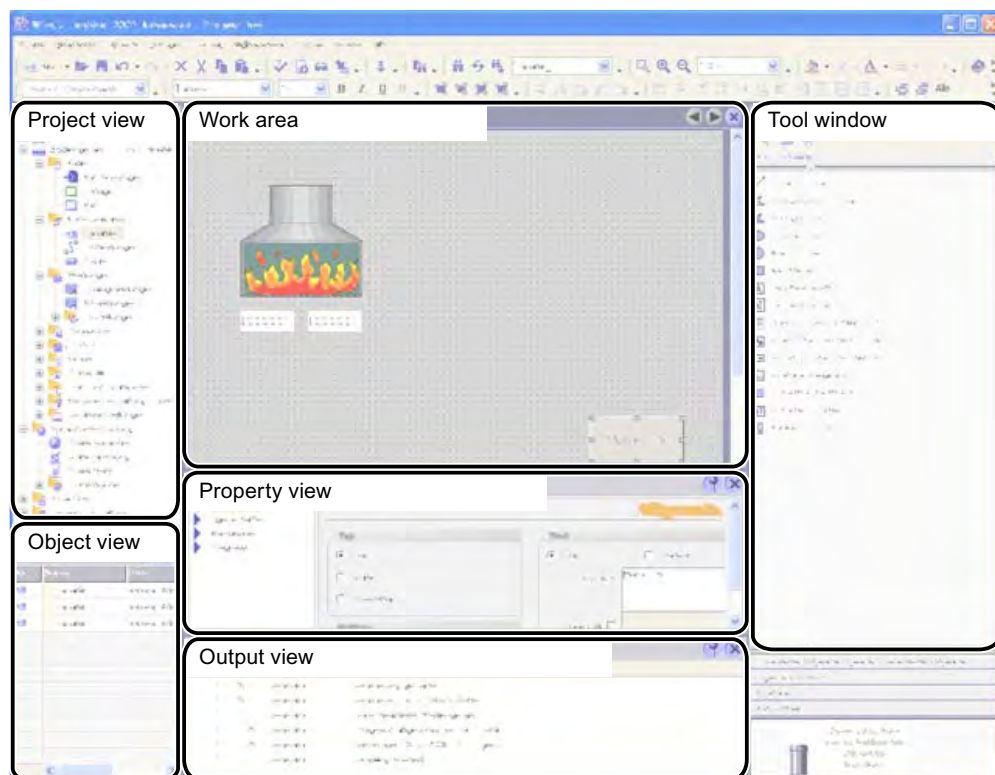

Menu bar

The menu bar contains all commands required for operating WinCC flexible. Any available shortcut keys are indicated next to the menu commands.

Toolbars

You can hide or show a specific toolbar.

Work area

You configure screens in the work area.

Toolbox

The toolbox contains a selection of simple and complex objects which you can add to your screens, for example, graphic objects or operating elements. In addition, the toolbox also provides libraries containing object templates and collections of faceplates.

Property view

The content of the property view is determined by the object you have currently selected in the work area.

- The properties of a selected object can be viewed and edited in the properties dialog box.
- If you have not selected an object on the active screen, the properties of this screen are shown and can be edited in the property view.

5.1.4 Procedures

Procedures

To create screens, you need to take the following initial steps:

- Create a draft of the process visualization structure, i.e. define the structure and the number of screens.

Example: Process partitions can be visualized in separate screens and merged in a master screen.

- Define your screen navigation control strategies.
- Adapt the template.

The template which is stored in WinCC flexible for the selected HMI device applies to all your project screens. In this template, you can define objects locally and assign global functions keys. For some of the HMI devices, you can store the objects you want to integrate into all screens in the permanent window.

- Create the screens. Use the following options of efficient screen creation:
 - Create a screen structure in the "Screen Navigation" editor.
 - Working with libraries
 - Working with faceplates
 - Working with layers

5.2 Configuring the navigation system

5.2.1 Navigating options

Introduction

A WinCC flexible project which consists of multiple screens offers the following screen navigation options in runtime:

- Navigation by means of navigating buttons
- Navigating with the help of function keys
- Navigation by means of the navigation control

WinCC flexible offers the following programming options:

- By programming buttons or function keys
- By graphical configuration via the "Screen Navigation" editor and the navigation control

Note

If you have set the "Visibility" animation to "Hidden" in the project view of a screen, this screen cannot be called up in Runtime.

5.2.2 Graphic programming of the screen navigation system

"Screen Navigation" editor

The "Screen Navigation" editor is used for the graphics configuration of the navigation between several screens. This editor allows you to organize your project screens in a hierarchical structure. Operators can use the navigation control in runtime to navigate between the various screens of the structure, for example, to change to the parent screen, or to the neighboring screen.

In addition to these structured connections, the "Screen Navigation" editor also allows you to generate direct screen connections, regardless of the given structure.

Open

To open the "Screen Navigation" editor, double-click on the "Screen Navigation" are under the "Device Settings" in the project view.

Layout

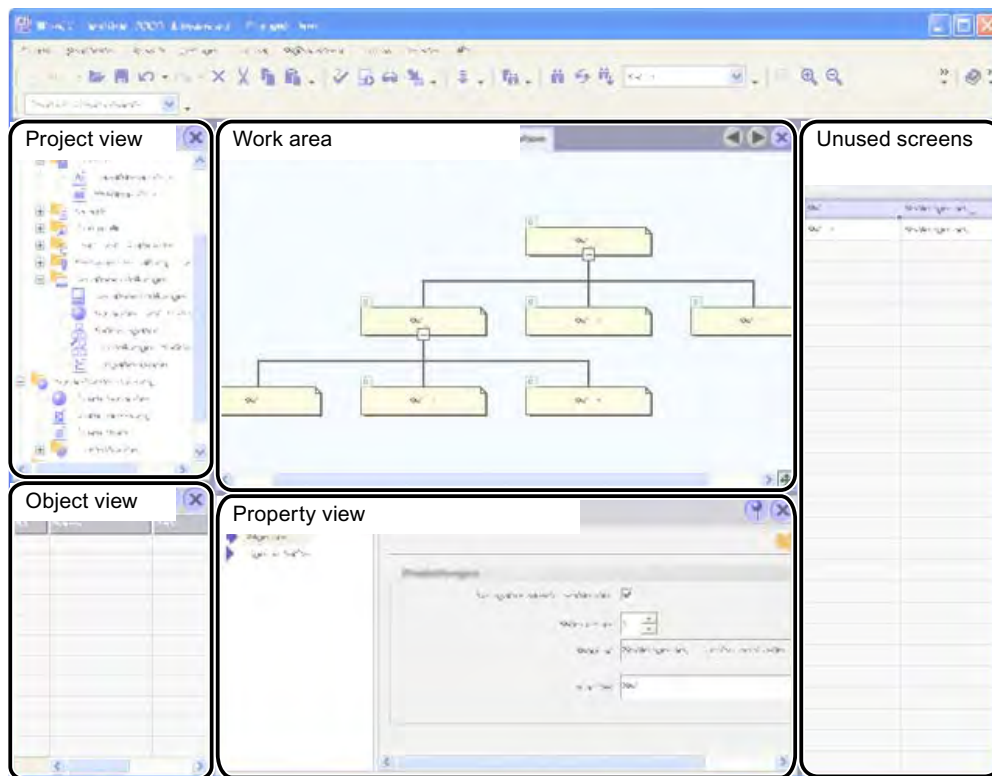

Menu bar

The menu bar contains all commands required for operating WinCC flexible. Any available shortcut keys are indicated next to the menu commands.

Work area

The view of the "Screen Navigation" editor shows the screen structure. The various screens are indicated by rectangles.

The screen interconnections correspond with your navigating options in runtime. The various interconnection types are identified by means of colored lines:

- Black lines reflect the structured screen interconnections.
- Green arrows represent direct screen connections, irrespective of the structure.

Shortcut menu

The context menu contains commands you can use to configure the "Screen Navigation" editor, and to create, open, delete, copy or rename screens.

Customizing the layout of the view

You have several options of customizing the view of the "Screen Navigation" editor:

- You can zoom in or out in the view in order to show either a larger or smaller section of the "Screen Navigation" editor.
- You can move this section using the  icon in order to display another section of your view.
- You can show a single screen, including all its child screens.
- You can hide or show all child screens.
- You can toggle between a horizontal and a vertical view.

"Unused screens"

The "Unused screens" view contains all the project screens which are not included in your navigation system. You can drag-and-drop "Unused screens" from this dialog box onto your view, and interconnect these with other screens.

Property view

The "Properties" dialog box of a screen allows you to enable the navigation control, to change the screen number, and to configure direct screen connections.

5.2.3 Using the navigation control

Using the navigation control

You can open a navigation control in all screens. The navigation control contains a number of preconfigured screen navigation buttons. These buttons can be used in runtime to call further screens of the project.

Customizing the navigation control

The navigation control is adapted in the "Screen Navigation" editor:

- You can display or hide the navigation control.
- You can configure the navigation control and the command buttons contained in it

The button is disabled if it is not assigned a target. In this case, the button appears in runtime without a label.

When you copy a screen which is used in screen navigation with a disabled navigation bar to the Project View and insert it in a different HMI, the copied screen is not displayed there in an existing screen navigation.

Note

Navigation buttons when changing HMI devices

Recompile the project after changing the HMI-device. The compiling ensures that all screens are converted to the current HMI device.

If you then change the HMI device again without first generating, it is possible that the navigation buttons will be shown differently in the individual screens.

5.3 Working with objects

5.3.1 Overview of Objects

Introduction

Objects are graphic elements which you use to design the process graphics of your project.

The "Toolbox" contains various types of objects which are frequently required for use in process screens.

The Toolbox view can be faded in and out using the "Toolbox" command in the "View" menu. The Toolbox view can be moved to any position on the screen.

The "Toolbox" contains various object groups, depending on the currently active editor. When the "Screens" editor is opened, the toolbox provides objects in the following object groups.

- "Simple objects"

Simple objects are graphic objects such as the "Line" or "Circle" and standard control elements, such as the "I/O field" or "Button".

- "Enhanced objects"

These objects provide an enhanced functional scope. One of their purposes is to display processes dynamically, e.g. integrating bars or Active X controls in the project, such as the Sm@rtClient view.

- "User-specific controls"

In this object group, you can add ActiveX controls which are registered in the Windows operating system of your PG / PC to the toolbox, and thus integrate them into your project.

- "Graphics"

Graphical objects e.g. of machinery and plant components, measuring equipment, control elements, flags and buildings are displayed thematically in a directory tree structure. You can also create shortcuts to your graphic files. External graphic objects in this folder, and in the nested folders, appear in the toolbox window and are thus integrated in the project.











- "Library"





A library contains object templates such as graphics of pipes, pumps, or default buttons. You can integrate multiple instances of a library object in your project, without any need to reconfigure these.

The WinCC flexible software package includes libraries. You may also store user-defined objects and faceplates in user libraries.













The "Faceplates" represent preconfigured object groups. Some of their properties, but not all of these, can be configured at the relevant place of their application. The faceplates can be edited from a central location. The use of faceplates helps you to reduce the work involved in configuration and ensure uniform project design.

Simple objects

Symbol	Object	Notes
	"Line"	You can select straight, rounded or arrow-shaped line ends.
	"Polyline"	A polyline consists of linked paths and can have any number of corners. The corner points are numbered in the order of their creation. The corner points can be modified or deleted individually. You can select straight, rounded or arrow-shaped polyline ends. The polyline is an open object. Although the start and end points may have the same coordinates, the area they enclose cannot be filled in.
	"Polygon"	The corner points of a polygon are numbered in the order of their creation. The corner points can be modified or deleted individually. You can fill a polygon area with a color or a pattern.
	"Ellipsis"	You can fill an ellipsis with a color or a pattern.
	"Circle"	You can fill the circle with a color or a pattern.
	"Rectangle"	The corners of a rectangle can be rounded. You can fill the rectangle with a color or a pattern.
	"Text box"	You can enter one or several lines of text in a "Text box" and define the font and the font color. You can add a background color or pattern to a text box.
	"I/O box"	An I/O box may have the following runtime functions: <ul style="list-style-type: none"> • Output of the values in a tag • Operator input of values; these input values are saved to a tag. • Combined input and output; the operator can here edit the output value of the tag and thus set a new value. You can define limits for the tag values shown in the I/O box. Set "Hide input" if you want to hide operator input in runtime.
	"Date-time box"	A "Date / time box" may have the following runtime functions: <ul style="list-style-type: none"> • Output of the date and time • Combined input and output; the operator can here edit the output values in order to reset the date and time. The system time or a corresponding tag may be used as source to define the date and time. The date can be output in extended format, for example, Tuesday, December 31, 2003, or in short format, for example, 12.31.2003.
	"Graphic IO field"	A "Graphic I/O box" may have the following runtime functions: <ul style="list-style-type: none"> • Output of graphic list entries • Combined input and output; the operator can here select a graphic from an graphic list in order to change the content of the "Graphic IO field." Example of its use as output field: To indicate the runtime status of a valve, the "Graphic I/O box" outputs the image of a closed or open valve.

Symbol	Object	Notes
	"Symbolic IO field"	<p>The "Symbolic I/O box" may have the following runtime functions:</p> <ul style="list-style-type: none"> • Output of text list entries • Combined input and output; the operator can here select a text from a text list in order to change the content of the "Symbolic I/O box." <p>Example of its use as combination I/O box: To control a motor in runtime, the operator selects the text "Motor OFF" or "Motor ON" from the text list. The motor is either started or stopped as selected, and the "Symbolic IO field" indicates the current status of the motor (motor OFF / motor ON.)</p>
	"Graphic view"	<p>The "Graphic view" shows you on one screen all of the graphic objects created by means of an external graphic programming tool. Graphic objects can be shown in the following formats: ".emf", ".wmf", ".dib", ".bmp", ".jpg", ".jpeg", ".gif" and ".tif".</p> <p>In the "Graphic view", you can also integrate graphic objects of other graphic programming tools as OLE (object linking and embedding) objects, for example. OLE objects opened and edited in the graphic program in which they were created directly from the property view of the graphic view.</p>
	"Button"	The operator can use a button to control a process. You can configure functions or scripts for a button.
	"Switch"	<p>The switch is used in runtime to input and visualize two states, for example, ON and OFF, or pressed and not pressed.</p> <p>It can be labeled with text or a graphic that indicates the runtime status of the switch.</p>
	"Bar"	The "Bar" represents a process value in the form of a scaled bar graph. A bar graph allows you to visualize, for example, dynamic values of filling levels.

Enhanced objects

Symbol	Object	Description
	"Slider"	The "Slider" is used for operator input and monitoring of numeric values. <ul style="list-style-type: none"> • When used as display instrument, the slider position indicates a process value which is output by the controls. • The operator inputs values by changing the slider position. You can customize the slider, so that it operates only in vertical direction.
	"Clock"	On your HMI device, you can view the clock in runtime either in digital or in analog format.
	"Status force"	The "Status / control" functions provide direct read / write access to specific address areas of the connected SIMATIC S7 or SIMATIC S5 CPU.
	"Sm@rtClient view"	The operator can monitor and operate a remote operator station by means of the "Sm@rtClient view ."
	"HTML browser"	The operator can view pages in HTML format by means of the HTML browser.
	"User view"	In WinCC flexible, you can use passwords to control access to screen objects. In the "User view", an administrator can manage users on the HMI device in Runtime. In the "User view", user who do not have administrator privileges can change their password in runtime.
	"Gauge"	The "Gauge" dial can display numerical values in runtime. The layout of the "Gauge" is configurable. You can customize the background image or the dial layout, for example.
	"Trend view"	In the "Trend view", you can show a group of trends which represent process values read from the PLC or from a log. The trend coordinates are configurable (scaling, units etc.).
	"Recipe view"	The operator can use the "Recipe view" in runtime to view, edit and manage data records.
	"Alarm view"	In the alarm view, the operator can view selected alarms or alarm events in the alarm buffer or the alarm log in runtime.
	"Alarm window"	In the "Alarm window", the operator can view selected alarms or alarm events in the alarm buffer or the alarm log in runtime. You always edit the template to configure the alarm window.
	"Alarm indicator"	The "Alarm indicator" warns the operator of alarm events which are not acknowledged yet. You always edit the template to configure the alarm indicator.
	Help indicator	The help indicator indicates available help texts for the screen being displayed or the objects contained on the screen. The help indicator is available for the HMI devices OP 73 and OP 73micro. You always edit the template to configure the help indicator.

Note

Some of the toolbox objects are either available with restricted functionality or not at all. This depends on the HMI device you are configuring. Unavailable properties of an object are displayed as deactivated and can not be selected.

5.3.2 Editing options of objects

Introduction

Objects are graphic elements which you use to design the screens of your project.

The following options for editing objects are available:

- Cutting, copying, inserting and deleting objects

To do this, use the following commands in the "Edit" menu:

- Cut
- Copy
- Insert
- Delete

If you copy an object in a screen and the screen already includes an object of the same name, the name of the object is changed. In order to access the properties of screen objects in scripts, all the objects within a screen and the template must have unique names.

- Maintaining the default size of the objects you are inserting, or customizing their size on insertion.
- Changing the properties of an object, e.g. the size
- Positioning an object
- Moving an object in front of or behind other objects
- Rotating objects
- Mirroring objects
- Changing default properties of the objects
- Defining the tab order for objects
- Stamping: Inserting several objects of the same type
- Selecting several objects simultaneously
- Repositioning and resizing multiple objects
- ActiveX controls that are registered in the Windows operating system can be added to or deleted from the "User controls" object group.
- You can assign external graphics to objects, e.g. in the Graphic View.

You can view only the images you have previously stored in the image browser of your WinCC flexible project.

You can save graphics in the image browser as follows:

- Via drag & drop from the "Graphics" object group to the working area
- As graphic files in the following formats: *.bmp, *.dib, *.ico, *.emf, *.wmf, *.gif, *.tif, *.jpeg or *.jpg
- As an OLE object

You either create a new OLE object or save an existing graphic file as an OLE object. To save an OLE object, an OLE-compatible graphics program must be installed on the configuration computer.

5.3.3 Repositioning and resizing multiple objects

Possible modifications

After you have selected multiple objects, you can edit these as follows:

- Shift using the mouse
 - To change the absolute position of the marked objects, position the mouse pointer over an object, and shift the multiple selection with the mouse button pressed.
 - In order to scale the object proportionally, keep the <Shift> key pressed while resizing it using the mouse.
- Shift using the functions of the "Alignment" toolbar
 - Change the position of the marked objects with respect to each other
 - Align the height and width of the marked objects

5.3.4 External graphics

Introduction

In WinCC flexible you can use images created with an external graphic editor. In order to use these graphics, store these in the image browser of the WinCC flexible project.

You can save graphics in the image browser as follows:

- If you drag and drop graphic objects from the "Graphics" object group onto the work area, they will be automatically stored in the image browser. The graphic names are numbered in order of their creation, e.g. Image_1. Use the <F2> key to rename graphics.
- As a graphics file with the following formats:
*.bmp, *.dib, *.ico, *.emf, *.wmf, *.gif, *.tif, *.jpeg or *.jpg
- As OLE object which is embedded in WinCC flexible and linked to an external graphic editor. With an OLE link, the external graphic editor can be opened from WinCC flexible. The linked object can be edited with the graphic editor. An OLE shortcut will only work if the external graphic editor is installed on your configuration computer and it supports OLE.

Using images from the image browser

You can use images from the image browser in your screens as follows:

- Graphic displays
- Image lists
- Function key labels

Transparent images

In WinCC flexible you also use graphics with a transparent background. When you insert an image with a transparent background in a WinCC flexible graphic object, the transparency is replaced by the background color defined in the WinCC flexible graphic object. The selected background color is permanently linked to the image. If you use the image in another WinCC flexible graphic object, it is displayed with the same background color as the graphic object which was configured first. If you want to use the image with different background colors, you have to add this image to the image browser again under a different name. Assign the additional background color to the appropriate WinCC flexible graphics object when you use the image.

Managing graphics

With WinCC flexible an extensive collection of graphics and symbols are installed, e.g.:

- Machine and plant parts
- Measuring equipment
- Control elements
- Flags
- Buildings

The graphic objects are filed thematically under "WinCC flexible graphics directory" in the "Graphics" object group. The reference to the graphics folder of WinCC flexible can not be removed, edited or renamed.

You can also manage your external graphic objects using the "Graphics" object group.
Available functions:

- Creating a reference to the graphics folders
 - External graphics that are placed in this directory and parent directories are shown in the toolbox window and thereby integrated into the project.
- Folder links
 - Editing
 - rename
 - Updating
 - Removing
- You can open the program for editing external graphics from WinCC flexible.

5.3.5 Object Groups

Introduction

Groups are several objects that are grouped together with the "Group" function. You edit a group in the same way as any other object.

Overview

WinCC flexible offers the following three methods of editing multiple objects together:

- Multiple selection
- Creating object groups
- Creating faceplates

The following table shows how the three methods differ from one another:

Methods of editing multiple objects together

	Multiple selection	Creating object groups (Groups)	Creating faceplates (Editor "Faceplates")
Resizing	✓	✓	✓
Scale group	✓	✓	✓
Changing the position	✓	✓	✓
Changing the display	✓	-	Special case
Store in library	-	-	✓

Editing mode

In order to edit an object of a group individually, change the editing mode in the shortcut menu. In this mode you can access an individual object and its properties.

Expanding groups

You can add further objects or groups to a group. The group is then increased by the new objects. If you then split the group again, all the objects are ungrouped, even those objects that you have added to the group as a group. The sequence in which you have grouped the objects is not taken into consideration.

Rectangle surrounding the object

With a group only one rectangle surrounding the object is shown for the entire group. However, in the case of a multiple selection, the rectangles surrounding all objects are displayed.

Layers

All objects of a group are located in the same layer.

5.3.6 Defining group properties

Introduction

You edit a group in the same way as any other object. The properties dialog box shows all the properties of the selected objects.

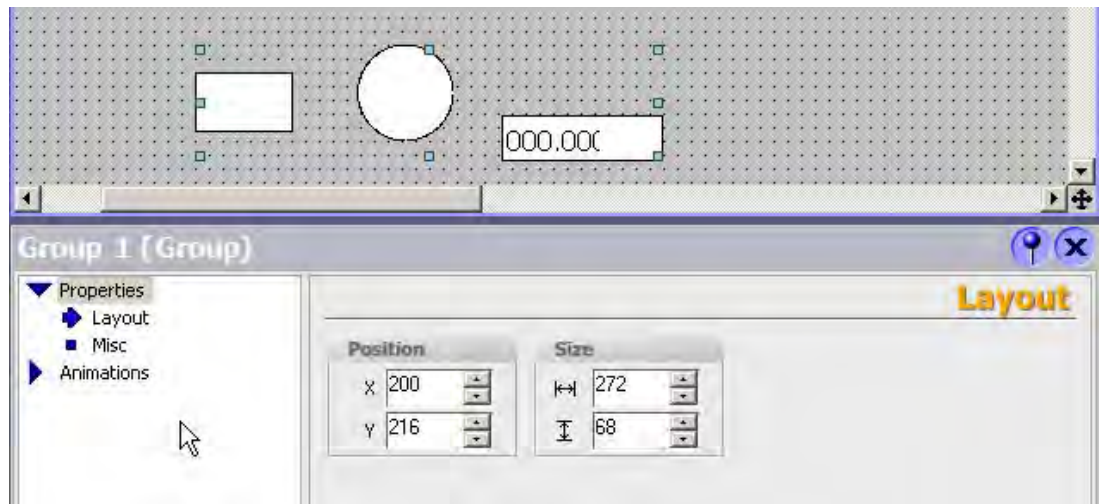

Changes to a shared group property affect all the single objects which are assigned this property.

Note the following rules when you reposition and resize a group:

- The system automatically adapts the position coordinates of the group objects when you reposition the group. The relative position of the individual objects to the group is not affected.
- The system automatically adapts the height and width of the group objects in proportion to a change of the group size.

5.4 Options of assigning dynamic update functions

Introduction

All objects for input and output demonstrate dynamic reactions in runtime. You can also assign dynamic properties to objects. An example of this feature is the graphic of a tank filling level which is dynamically updated based on the respective process value. Another example of the dynamic response of an object is a button which triggers a particular function.

Dynamic objects

You can assign dynamic properties to any graphic object. Programming options:

- The object changes its appearance: Color or flashing properties.
- The screen object is animated.
- The object is shown or hidden.

The following additional options are available for the control elements:

- Operator control of an object is enabled or locked.
- The operator control, e.g. clicking, of an object triggers an event which is configured to execute a function list.

Dynamic control and object properties

Dynamic control is an element of the object properties. Which dynamic control functions and events are actually available depends on the selected object. When you copy an object, its dynamic control functions are included.

5.5 Working with function keys

Introduction

The function key is a physical key on your HMI device and its functions can be configured. A function list can be configured on the events "Press" and "Release" of the key.

A function key can be assigned global or local functions.

Global assignment

Global function keys always trigger the same action, regardless of the currently displayed screen.

Global function keys are configured once in the template. A global assignment applies to all screens of the selected HMI device which are based on this template.

Global function keys reduce programming considerably, because there is no need to assign these global keys to each individual screen.

Local assignment

Local function keys in screens can trigger a different action in each screen. This assignment applies only to the screen in which you have defined the function key.

Using a local function key you can overwrite global function keys and the local function keys of a template.

Note

If a screen with local function keys is overlapped by an alarm view or an alarm window, then the function keys are still active in runtime. This can particularly be the case with HMI devices with small displays (e.g. OP 77B).

Hotkey assignment





You can assign hot keys, e.g. buttons, to HMI devices. Which hot keys are available depends on the HMI device.

Graphics

When a function key is placed directly next to the display, you can assign a graphic to it to make the function of the function key more clear.

Display of assignment

The following table shows which symbols display the assignment of the function keys:

Function key	Description
	Unassigned
	Used globally
	Used locally
	Used locally (local assignment overwrites global assignment)
	Assigning buttons with screen navigation

5.6 The Advantage of Layers

Layers

Use layers in order to achieve differentiated editing of the objects in a screen. A screen consists of 32 layers. If you assign objects to the layers, you thereby define the screen depth. Objects of layer 0 are located at the screen background, while objects of layer 31 are located in the foreground.

The objects of a single layer are also arranged hierarchically. When you create a screen, the object inserted first is located at the rear within the layer. Each further object is placed one position towards the front. You can shift objects forwards and backwards within a layer.

Principle of the layer technique

Always one layer of the 32 layers is active. New objects you add to the screen are always assigned to the active layer. The number of the active layer is indicated in the "Layer" toolbar and in the Properties view of the screen. The active layer is highlighted in color in the Properties view of the screen.

When you open a screen, all 32 layers of the screen are displayed. You can hide all layers except the active layer in the Properties view of the screen. You then explicitly edit objects of the active layer.

Application examples

Use layers, for example, in the following cases:

- To hide the labeling of objects when editing.
- To hide objects, e.g. alarm windows, while configuring screens further.

5.7 Object Libraries

Introduction

Libraries are a collection of screen object templates. They enhance the collection of available screen objects and programming efficiency, because library objects are always available for reuse without the need to reconfigure them. Your WinCC flexible software package is supplied with comprehensive libraries which contain, for example, "Motor" or "Valve" objects. You may, however, define your own library objects.

Libraries are managed in the "Libraries" toolbox window of the "Screens" editor. The toolbox displays write-protected libraries in italic font. The write-protected system library is always displayed in italic fonts. Write-protected libraries cannot be edited.

Note

A library which is open in several applications cannot be saved using the "Save as version" function.

Project library

There is one library for each project. Objects of the project library are stored alongside with the project data and are available only for the project in which the library was created. When you move the project to a different computer, the project library created therein is included. The project library remains hidden as long as it does not contain any objects. In the shortcut menu of the library view, select the command "Display project library" or drag the screen object into the library view to display the project library.

Global libraries

In addition to the objects from the project library, you can also incorporate objects from shared libraries in your projects. A global library is stored independent of project data in a separate file with the extension *.wlf.

When a global library is used in a project, you generate only one reference to this library in the relevant project. The shared libraries are not automatically included when you move the project to a different computer. The interconnection between the project and the shared library may be lost in the course of this action. This interconnection will also be lost if the global library is renamed in a different project or in an application other than WinCC flexible.

A project can access multiple global libraries. A global library may be used concurrently in multiple projects.

When a library object is changed by a project, this library is opened in all other projects in this modified state.

Among the shared libraries you will also find the libraries supplied with your WinCC flexible package.

Categories

To sort library objects by topics, you can either split a library into categories, or create several global libraries. A particular global library may contain all of the objects you need to configure motor controls, for example. Another global library may contain all of the objects you need to configure the pump controls.

Library objects

A library may contain all the WinCC flexible objects, e.g. screens, tags, graphic objects or alarms.

To use a library object in a project, copy the object and all referenced objects to the project. The copied object loses its interconnection with the library. Changes in the library do not affect any of the copied library objects.

If you wish to use multiple instances of configurable object groups and edit these centrally, you need to create faceplates.

5.8 Working with faceplates

5.8.1 Faceplate basics

Introduction

Faceplates are objects that you compile from existing screen objects.

Faceplates offer the following advantages:

- Central modification
- Reuse in other projects
- Reduction of engineering time

Faceplates are created and edited in the "Faceplate" editor. The faceplates you create are added to the "Project library", and can be inserted into screens in the same way as other objects.

Faceplate configuration

The "Faceplate" editor comprises the "Screens" editor and the "Faceplate configuration" dialog.

"Screens" Editor

In the "Screens" editor you place the objects you would like to have in the faceplate. You can remove objects or use the toolbox to add new objects.

"Faceplate configuration" dialog

The "Faceplate Configuration" dialog has the following entries:

- General

Here you can set the name of the faceplate. It is under this name that the faceplate will appear in the "project library".

You determine the behavior of the faceplate aspect ratio.

Use the corresponding buttons to export or import any texts you may be using in the faceplate.

- Properties

Here you can set the properties of the faceplate. The properties included here can be configured in future configurations just the same as all the other object properties.

You can also create faceplate tags. The faceplate tags are available only within the faceplate. The faceplate tags are directly interconnected to an object contained within a faceplate, e.g. to an IO field.

- Events

Here you can set the events of the faceplate. The events included here can be configured in the future configuration work just the same as all the other object properties.

- Script

You configure the script for the faceplates here. Under Script you can call the system functions or program new functions, e.g. to convert values. The script is available only from within the faceplate.

Application example

For instance, you can define a faceplate "operating element". The faceplate consists, for example, of the following elements:

- Bar
- Text field for the name
- Output mode
- Button.

In the faceplate you interconnect the event "click" of the button to a script. This script calculates, e. g. the average value of two process tags. This dynamic control is integrated in the faceplate. You can preconfigure the faceplate in such a way that every faceplate instance that is created from it possesses the same dynamic control.

Using faceplates

After you have created it, the faceplate appears as an object in your project library.

You can now insert the faceplate into your process screens, and configure it in the Properties window for the relevant usage location.

Faceplate instance

Inserting a faceplate into a process screen creates an instance of this faceplate. If you edit the faceplate in the project library, the faceplate instance generated from this will be updated automatically.

Reusing the faceplate instance

The dynamic controls that you have configured directly to the object properties of the objects contained in the faceplate, are included in each faceplate instance.

Alternatively, preconfigure the instance of a faceplate and then reuse it. Each newly generated instance then carries out the same script or uses the same tag for example. You can drag the final configured instance of a faceplate into a library and reuse it later. This preconfigured faceplate instance can continue to be used even if the faceplate is changed. This means, however, that the interface of the faceplate must remain essentially unchanged.

Configuring security levels

You cannot assign levels of security within faceplates, as a preconfigured level of security would only be valid within the faceplate and not in the project in which the faceplate instances are used. To configure the security levels, connect the "User authorization" property of the objects in the faceplate to the interface. You then assign the user authorizations to the respective faceplate instance.

Reusing faceplates in multiple projects

WinCC flexible allows you to add faceplates to a global library. This means you can use the faceplates in other projects. When you add a faceplate from the shared library to the screen, the system automatically saves a copy of it to the project library. Change the faceplate from the project library.

5.8.2 Dynamic control options

Introduction

You can dynamically control events and properties of faceplates in two ways:

- On a faceplate instance

On a faceplate instance, the events or dynamic properties can be configured individually for the usage location. To do this, first of all set up the respective properties and events on the interface.

- On an object included in the faceplate

You can directly configure properties, events and animations for an object that is included in the faceplate. The properties and animations can be interconnected with faceplate tags or dynamic properties.

In addition, you can link process values of the objects included in the faceplate with dynamic properties. To do this, first of all set up the respective properties on the interface. In this way you can preconfigure the faceplate. Every faceplate instance that is generated from this possesses the same dynamic control. You can edit this dynamic control only in the "Faceplates" editor.

Creating an Alarm System

6.1 Basics

6.1.1 Visualization of process and system alarms

Introduction

- User-defined alarms

You configure alarms to display process states or measure and report process data that you receive from the PLC on the HMI device.

- System alarms

System alarms are predefined in these devices to display particular system states in the HMI device or the PLC.

Both user-defined alarms and system alarms are triggered by the HMI device or the PLC and can be displayed on the HMI device.

Tasks of the alarm system

- Visualization on the HMI: To report events or states that occur in the plant or the process. A state is reported as soon as it occurs.
- Reporting: Alarm events are output to a printer.
- Logging: Alarm results are saved for further editing and evaluation.

6.1.2 User-defined alarms

6.1.2.1 Available Alarm Procedures

Alarm methods in WinCC flexible

An alarm method identifies the type of information that triggers an alarm and therefore the alarm properties.

WinCC flexible supports the following alarm procedures:

- Discrete alarm procedure

The HMI device triggers an alarm if a particular bit is set in the PLC. Discrete alarms are configured for this purpose in WinCC flexible.

- Analog alarm procedure

The HMI device triggers an alarm if a particular "tag" violates a "limit value." Analog alarms are configured for this purpose in WinCC flexible.

- Alarm number procedure

The PLC transfers an alarm number (and any associated alarm text) to the HMI device. Various alarms can be configured for this purpose in the configuration software of the PLC:

- In SIMATIC STEP 7:
ALARM_S alarms
- In SIMOTION SCOUT:
ALARM_S alarms and technological alarms

Acknowledging Alarms

For alarms displaying critical or hazardous operating and process states, a stipulation can be made requiring the plant operator to acknowledge the alarm.

If you want to only allow an authorized user to edit alarm messages, you should also assign a corresponding user authorization to the "ACK" button on devices with keypads.

Alarm states

The following alarm statuses exist for discrete alarms and analog alarms:

- When the condition for triggering an alarm is satisfied, the alarm status is "Activated." Once the operator has acknowledged the alarm, it assumes the "Activated/acknowledged" status.
- When the condition for triggering an alarm no longer applies, the alarm status is "Activated/deactivated." Once the operator has acknowledged the deactivated alarm, it has "Activated/deactivated/acknowledged" status.

Each occurrence of an alarm status can be displayed and logged on the HMI device as well as printed out.

6.1.2.2 Acknowledging Alarms

Introduction

For discrete and analog alarms displaying critical or hazardous operating and process states, a stipulation can be made requiring the plant operator to acknowledge the alarm.

Mechanisms for acknowledging alarms

An alarm can be acknowledged either by the operator on the HMI device or by the control program. When an alarm is acknowledged by the operator, a bit can be set within a tag.

The following options are useful for acknowledgment by the operator:

- Acknowledgement key <ACK> (only available on certain HMI devices)
- Function keys, softkeys or buttons in screens

In addition, alarms can be acknowledged through system functions in function lists or scripts.

Note

If you want to only allow an authorized user to edit alarm messages, you should also assign a corresponding user authorization to the "ACK" button on devices with keypads.

Alarms requiring acknowledgment

The alarm class determines whether or not the alarm must be acknowledged.

Alarm classes essentially define how alarms will appear when shown on the HMI device as well as the acknowledgement behavior. WinCC flexible has both predefined alarm classes and the option to configure user-defined alarm classes.

Acknowledgment by the PLC

A discrete alarm can be acknowledged by setting a specific bit within a tag in the PLC.

Acknowledging alarms collectively

When configuring alarms, you can specify whether alarms must be acknowledged individually by the operator or whether alarms in the same alarm group can be acknowledged together. It is helpful to use alarm groups, for example, when alarms are caused by the same error.

6.1.2.3 Alarm classes

Alarm classes

Alarm classes mainly determine how alarms will appear when they are displayed on the HMI device. Alarm classes are also used to group alarms for various means of display.

WinCC flexible has both predefined alarm classes and the option to configure user-defined alarm classes.

Available alarm class settings

The following settings can be defined for each alarm class:

- Acknowledge: Alarms in this class must be acknowledged.
- Texts, colors, and flash modes to identify each alarm status when alarms are displayed
- An alarm log for logging all events related to alarms in this class.
- A text placed in front of the alarm number to indicate the alarm class when alarms are displayed on the HMI device.
- An e-mail address to which all messages about events related to the alarms in this class will be sent.

Predefined alarm classes in WinCC flexible

- "Errors" for discrete and analog alarms that indicate critical or hazardous operating and process states. Alarms in this class must always be acknowledged.
- "Warnings" for discrete and analog alarms that indicate regular operating states, process states, and process sequences. Alarms in this class do not require acknowledgement.
- "System" for system alarms that notify the operator about the operating states of the HMI device and the PLCs. This alarm class cannot be used for user-defined alarms.
- "Diagnosis Events" for S7 diagnostic messages that indicate states and events of the SIMATIC S7 or SIMOTION PLCs. Alarms in this class do not require acknowledgement.

Only very specific properties can be changed for predefined alarm classes.

6.1.3 System alarms

Introduction

System alarms notify the operator about the operating states of the HMI device and the PLCs. System alarms can range from notes to serious errors.

Triggering of system alarms

The HMI device or the PLC triggers an alarm if a certain system status or an error occurs in one of these devices or during communication between two devices.

A system alarm consists of the number and the alarm text. The alarm text can also contain internal system tags that indicate the cause of the alarm more precisely. Only certain properties can be configured for system alarms.

Types of system alarms

There are two types of system alarms:

- HMI system alarms

HMI system alarms are triggered by the HMI device if certain internal states occur or an error occurs during communication to the PLC.

- System alarms by the PLC

These system alarms are generated by the PLC and cannot be configured in WinCC flexible.

Displaying system alarms on the HMI device

In the basic settings for the alarm system, you can specify the type of system alarms to be displayed on the HMI device and how long a system alarm will be displayed.

To display system alarms on the HMI device, use the "alarm view" and "alarm window" objects.

Select the "System" alarm class setting each time one of these objects is configured in a screen or the template.

Device-specific system alarms

The manual for your HMI device contains a list of the possible system alarms along with the cause and available countermeasures.

If you contact online support due to an HMI system alarm, you will need the alarm number and any system alarm tags.

6.1.4 Displaying Alarms

6.1.4.1 Displaying Alarms on the HMI Device

Options for displaying alarms on the HMI device

WinCC flexible offers the following options for displaying alarms on the HMI device:

- Alarm view

The alarm view is configured for a certain screen. More than one alarm can be displayed simultaneously, depending on its configured size. More than one alarm view can be configured for different alarm classes and in different screens.

The alarm view can be configured in such a way that it includes only one alarm line.

- Alarm window

The alarm window is configured in the screen's template and is thus a component of all screens in a project. More than one alarm can be displayed simultaneously, depending on its configured size. An event can trigger closing and reopening of the alarm window. Alarm windows are saved in their own layer for the practical reason that this allows them to be specifically hidden during the configuration.

Additional signal: Alarm indicator

The alarm indicator is a configured graphic symbol that is displayed on the screen when an alarm activates. The alarm indicator is configured in the screen's template and is thus a component of all screens in a project.

The alarm indicator can have one of two states:

- Flashing: At least one unacknowledged alarm is pending.
- Static: The alarms are acknowledged but at least one of them is not yet deactivated.

Function lists can be used to configure HMI device responses.

Alarm view

The following HMI devices update the tag value in an alarm if the alarm status has changed, for example, by acknowledgment.

- OP 73micro
- TP 177micro
- OP 73
- OP 77A
- TP 177A

The tag value at other HMI devices remains unchanged.

If pending and unacknowledged alarms are displayed in an alarm view, the displayed alarms are not re-sorted on the following HMI devices after the acknowledgement of an alarm.

- OP 73micro
- TP 177micro
- OP 73
- OP 77A
- TP 177A

6.1.4.2 Filtering the display of alarms

Introduction

In the extended Alarm View and Alarm Window, you have the possibility of filtering the display of alarms via the alarm text of the alarms. A character string or the value of a filter variable is used as the filter criterion. In Runtime, only the alarms whose alarm text contains the configured character string or the character string from the filter variable are displayed. The filter only applies to the display in runtime. All alarms are retained in the alarm buffer.

Filtering rules

For filtering using a fixed filter entry, configure a character string in the properties of the Alarm View. All the alarms which contain the full character string in the alarm text are displayed in runtime.

Use a tag for the filter criterion for modifiable filtering. The tag can be obtained in runtime e.g. via an I/O field with the desired character string. The display of the alarms is filtered in accordance with the contents of the tag.

Behavior of the filter

- If the filter entry is empty, all the pending alarms are displayed.
- The filter tag is superordinate to the permanently configurable character string. If a permanently assigned character string and filter tag are assigned during configuration, the alarms are filtered by the contents of the filter tag. If the filter tag is empty, filtering is by the permanently assigned character string.
- Filtering is case sensitive. Wildcards and regular expressions are not taken into account.
- Filtering is not language dependent. A configured character string remains the same after a language change.
- The length of the filter entry is limited to the maximum length of the alarm text. The maximum length of the alarm text is determined by the HMI device used. Refer to the chapter "System limits" section for more information about length.

Configure filtering in the properties of the alarm view or the alarm window.

Filtering is not possible for the following alarm views:

- Simple Alarm View
- Alarm line
- Alarm window which is automatically displayed
- Alarm view which is configured for displaying alarms of an alarm log
- Alarm window which is configured for displaying alarms of an alarm log

6.1.4.3 Logging and reporting alarms

Evaluation and documentation of alarms

In addition to real time displays of alarm events in the "alarm view" and "alarm window," WinCC flexible offers the following options for evaluating and documenting alarms:

- Alarm events can be printed out immediately upon occurrence.
- Alarm events from the alarm buffer can be printed out in report form.
- Alarm events can be logged in an alarm log.
- Logged alarm events can be displayed on the HMI device or printed out in report form.

Printing Alarms Immediately

You can enable or deactivate the printing of alarms for the entire project in the basic settings for the alarm system. In addition, printing of each individual alarm can be enabled.

Logging of alarms

Alarm classes are used to configure assignment of alarms to an alarm log. An alarm log can be specified for each alarm class. All events related to the alarms of this alarm class are logged in the specified alarm log.

Reporting of alarms

The properties of the "Print alarm" object are used to configure the assignment of alarms to a report. In addition to the data source (alarm buffer or alarm log), filtering is also possible on the basis of alarm classes.

6.1.4.4 System Functions for Alarm Editing

System functions

System functions are predefined functions you can use to implement many tasks during runtime even without having any programming knowledge. You can use system functions in a function list or in a script.

The table shows all of the system functions available for editing alarms and manipulating their display.

System function	Effect
EditAlarm	Triggers the "Edit" event for all selected alarms.
ClearAlarmBuffer	Deletes alarms from the alarm buffer on the HMI device.
ClearAlarmBufferProtooLegacy	Function like "ClearAlarmBuffer". This system function has been retained to ensure compatibility and used the old ProTool numbering.
AlarmViewEditAlarm	Triggers the event "Edit" for all alarms selected in the given alarm screen.
AlarmViewAcknowledgeAlarm	Acknowledges the alarms selected in the given alarm view.
AlarmViewShowOperatorNotes	Displays the configured operator notes of the alarm selected in the given alarm screen.
AcknowledgeAlarm	Acknowledges all selected alarms.
SetAlarmReportMode	Switches the automatic reporting of alarms on the printer on or off.
ShowAlarmWindow	Hides or shows the alarm window on the HMI device.
ShowSystemAlarm	Displays the value of the delivered parameter as a system alarm on the HMI device.

For details on these system functions, refer to "Working with WinCC flexible > Reference > System functions."

Events for alarms and objects for alarm indication

The following events can occur during runtime in the case of alarms and in the case of objects for alarm displays. A function list can be configured for each event.

Object	Configurable events
Discrete alarms	Activate Deactivate Acknowledge Edit
Analog alarm	Activate Deactivate Acknowledge Edit
Alarm view	Enable Deactivate
Alarm indicator	Click Click when flashing

For details on these events, refer to "Working with WinCC flexible > Reference > System functions."

6.2 Elements and basic settings

6.2.1 Alarm Components and Properties

Properties of alarms

An alarm always comprises the following components:

- Alarm text

The alarm text contains a description of the alarm. Character formats supported by the relevant HMI device can be used to format the alarm text on a character-by-character basis.

The operator note can contain output fields for the current values of tags or text lists. The alarm buffer retains the instantaneous value at the time at which the alarm status changes.

- Alarm number

The alarm number is used to reference an alarm. Each alarm number is unique within the following types of alarms:

- Discrete alarms
- Analog alarms
- HMI system alarms
- Alarms from the PLC within a CPU

- Alarm triggers

- For discrete alarms: A bit within a tag
- For analog alarms: The limit value for a tag

- Alarm class

The alarm class of an alarm determines whether or not the alarm has to be acknowledged. It can also be used to determine how the alarm appears when it is displayed on the HMI device. The alarm class also determines whether and where the corresponding alarm is logged.

Note

If you want to integrate a project in SIMATIC STEP 7, you can configure a maximum total of 7 alarm classes in WinCC flexible and STEP 7.

These components are freely selected or entered for each alarm.

Optional alarm properties

The behavior of an alarm can also be defined by the following properties:

- Alarm group
If an alarm belongs to an alarm group, it can be acknowledged along with other alarms in the same group in a single operation.
- Infotext
Operator notes can contain additional information about an alarm. Operator notes are displayed in a separate window on the operator device when the operator presses the <HELP> button.
- Automatic reporting
In addition to the option of enabling and disabling automatic reporting of alarms for the entire project, it is also possible to enable reporting for each individual alarm.
- Acknowledging by the PLC "Acknowledgement write tag"
A discrete alarm can be acknowledged by the PLC program by setting a particular bit within a tag.
- Sending an acknowledgement to the PLC "Acknowledgment read tag"
When a discrete alarm is acknowledged by the operator, a particular bit can be set within a tag.

6.2.2 Editors for Configuring Alarms

6.2.2.1 Basic Principles of Editors

Editors for configuring alarms

WinCC flexible contains the following tabular editors for configuring alarms:

- "Discrete alarms" editor for creating and changing discrete alarms
- "Analog alarms" editor for creating and changing analog alarms
- "System alarms" editor for changing alarm texts of system alarms
- "Alarm classes" editor for creating and changing alarm classes
- "Alarm groups" editor for creating and changing alarm groups

Working with the editors

The following functions are available in all editors:

- Changing the column display
- Deleting and copying objects
- Automatically filling multiple table rows
- Copying properties per drag-and-drop
- Copying objects from the object window with drag-and-drop
- Sorting table contents

Changing column displays

Configure the column display as follows:

- Hide or show columns
Select the column header in the shortcut menu.

This function is not available in the "Alarm groups" editor because this editor consists of only two columns.
- Change column width
Drag the right edge of a column header to the desired width.
- Change the order of columns
Select the column and drag the column header to the desired position.

This function is not available in the "Alarm groups" editor.
- Sort
Click on a column header. If you click again on the same column header you return to the sorting order again.

The corresponding column header is marked with an arrow. The arrow direction indicates the sorting order.

Deleting and copying objects

Delete or copy one or more whole objects by clicking on the symbol on the left edge of the row. This marks the entire table row.

Automatically filling multiple table rows by dragging

In tabular editors of WinCC flexible, you can fill in multiple table rows in one operation. You can use this function for the following tasks:

- Creating multiple new objects (alarms, alarm classes, or alarm groups) with similar properties. Proceed as follows:
 - Sort the table so that the table row to be copied is at the bottom.
 - Select the first element in the row to be copied.
 - Drag the bottom right corner of the selected table element in the lower empty table area.
- Transferring a property to more than one existing object (for example, changing the trigger tags): Proceed as follows:
 - Select the table element with the relevant property.
 - Drag the lower right-hand corner of the selected table element downwards across the table rows to be modified.

Copying properties within a table per drag-and-drop

You can use a drag-and-drop operation to copy an individual property (such as an alarm text or a color) from one table element to another.

Dragging and dropping from the object window.

You drag an object from the object window, e.g. a tag, to a table cell per drag-and-drop. This function is only possible if the table cell permits the use of the object.

6.2.2.2 "Discrete alarms" editor

Introduction

You create discrete alarms and specify their properties in the "Discrete alarms" tabular editor.

Open

In the project view, double-click "Discrete alarms" in the "Alarms" group.

Layout

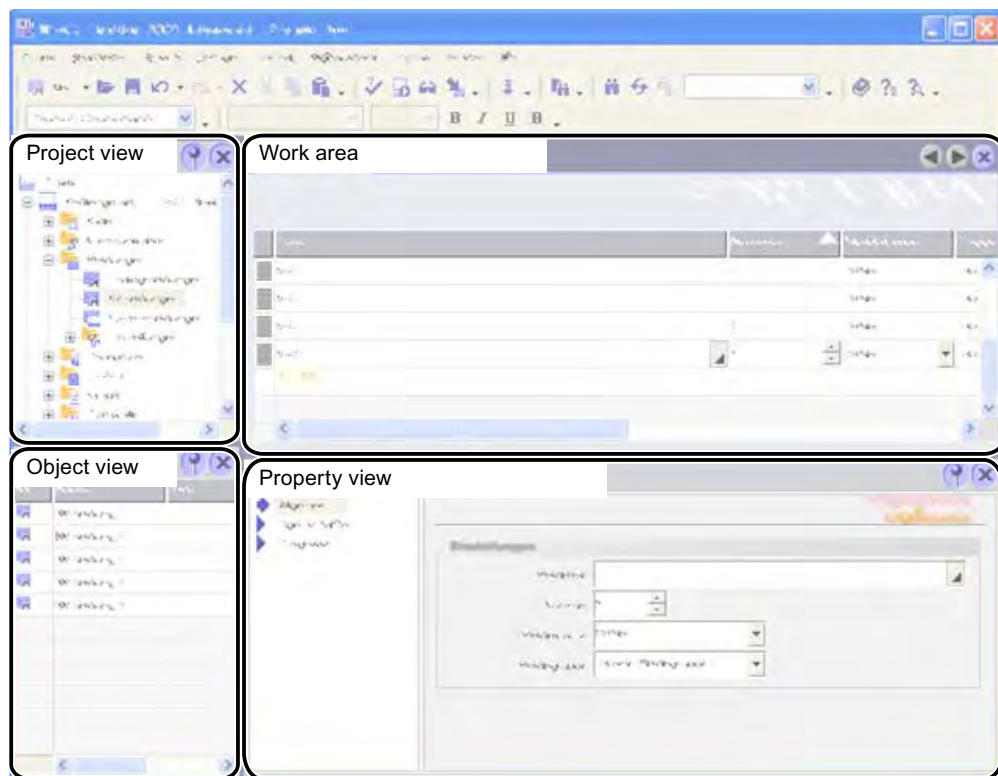

Work area

The work area shows in tabular form all the established discrete alarms and the associated settings. You can edit the properties of the discrete alarms in the table cells.

Property view

Configure the discrete alarm in the property view. The view offers the same information and settings as the work area table.

6.2.2.3 "Analog alarms" editor

Introduction

You create analog alarms and specify their properties in the "Analog alarms" tabular editor.

Open

In the project view, double-click "Analog alarms" in the "Alarms" group.

Layout

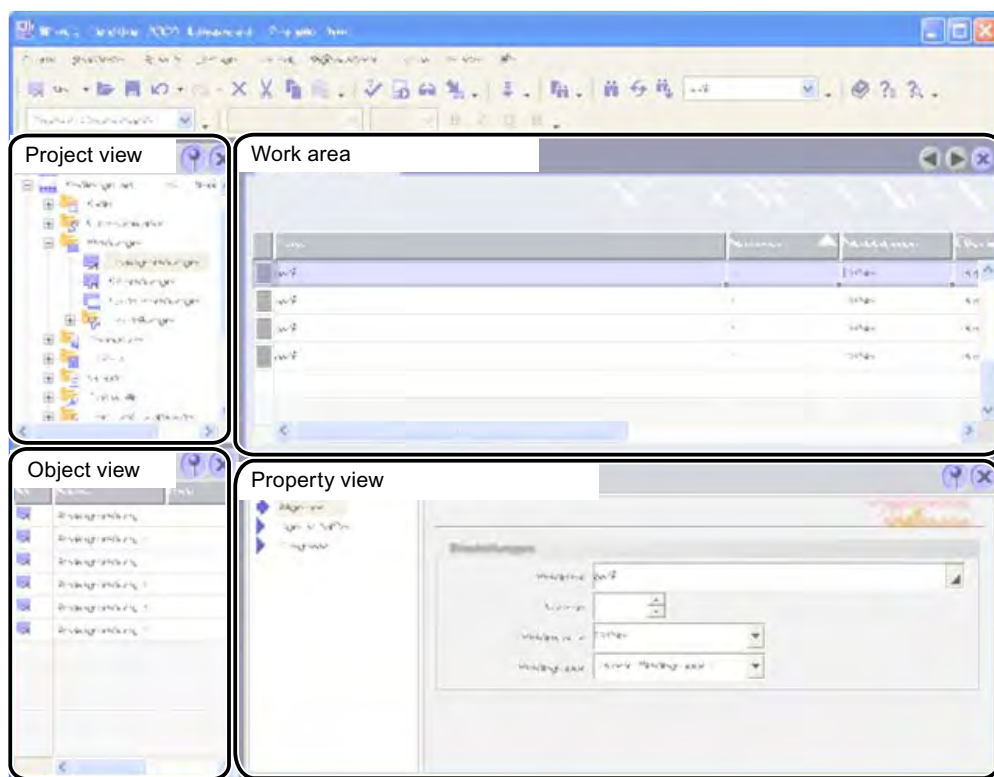

Work area

The work area shows in tabular form all the established analog alarms and the associated settings. You can edit the properties of the analog alarms in the table cells.

Property view

Configure the analog alarm in the property view. The view offers the same information and settings as the work area table.

6.2.2.4 "System alarms" editor

Introduction

The "System alarms" tabular editors shows all the HMI system alarms. You can change the alarm text of the system alarms.

Open

The "System alarms" entry is not visible with the default settings of WinCC flexible. Display the entry as follows:

1. Select "Settings" from the "Options" menu.
2. Open the "Workbench > Settings for project view" category in the "Settings" dialog.
3. Select the "Display all items" in the "Change the mode in which the project tree is shown" field.

If the "System alarms" entry is visible in the project view, double-click on "System alarms" in the "Alarms" group.

Layout

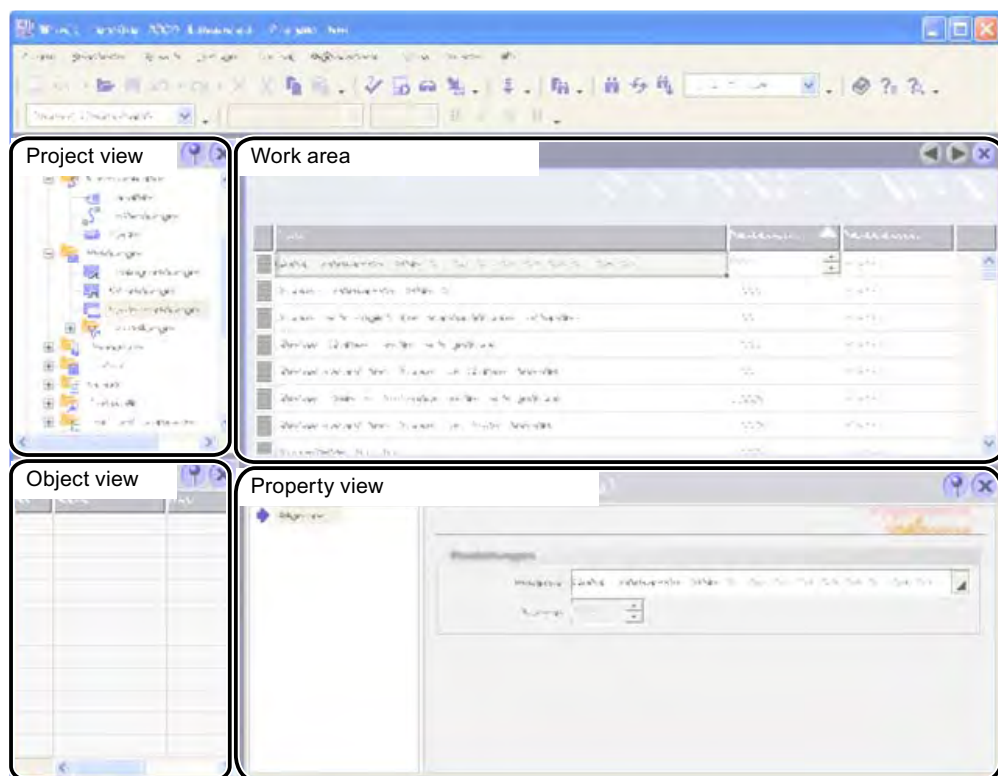

Work area

The work area shows in tabular form all the established system alarms and the associated settings. You can edit the alarm text of the system alarm in the table cells.

Property view

The alarm text of the system alarm is modified in the property view the alarm number and alarm class are assigned by the system.

6.2.2.5 "Alarm classes" editor

Introduction

You create alarm classes and specify their properties in the "Alarm classes" tabular editor.

Open

In the project view, double-click "Alarm classes" in the "Alarms > Settings" group.

Layout

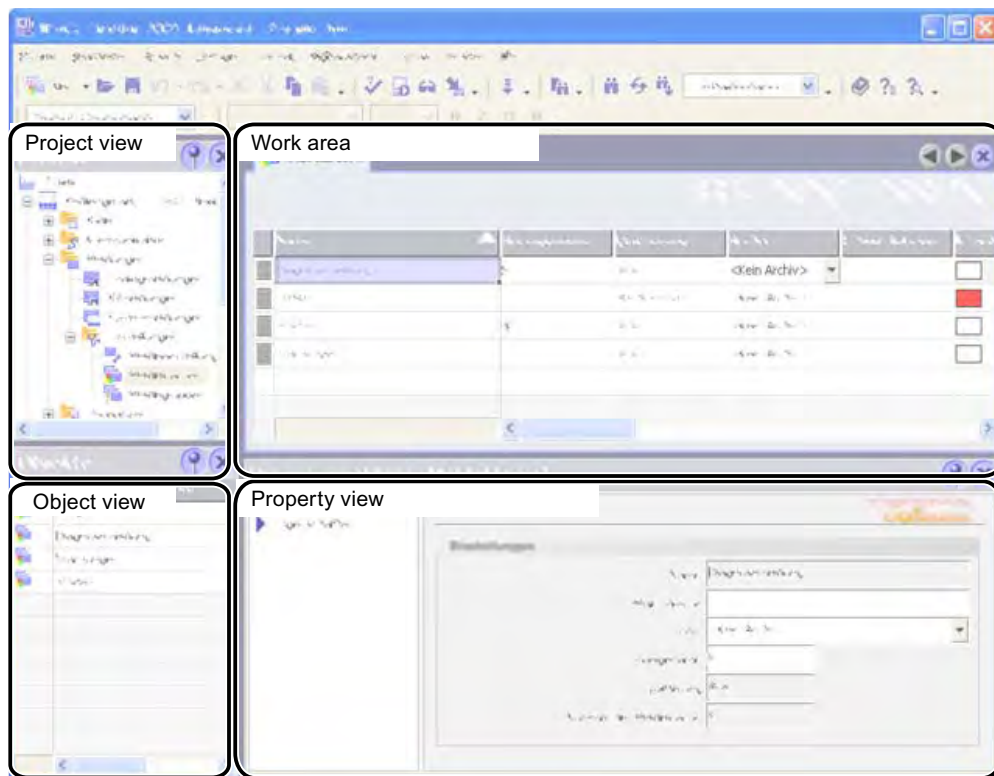

Work area

The work area shows in tabular form all the established alarm classes and the associated settings. You can edit the properties of the discrete alarms in the table cells.

Property view

Configure the alarm classes in the property view. The view offers the same information and settings as the work area table.

6.2.2.6 "Alarm groups" editor

Introduction

You create alarm groups and specify their properties in the "Alarm groups" tabular editor.

Open

In the project view, double-click "Alarm groups" in the "Alarms > Settings" group.

Layout

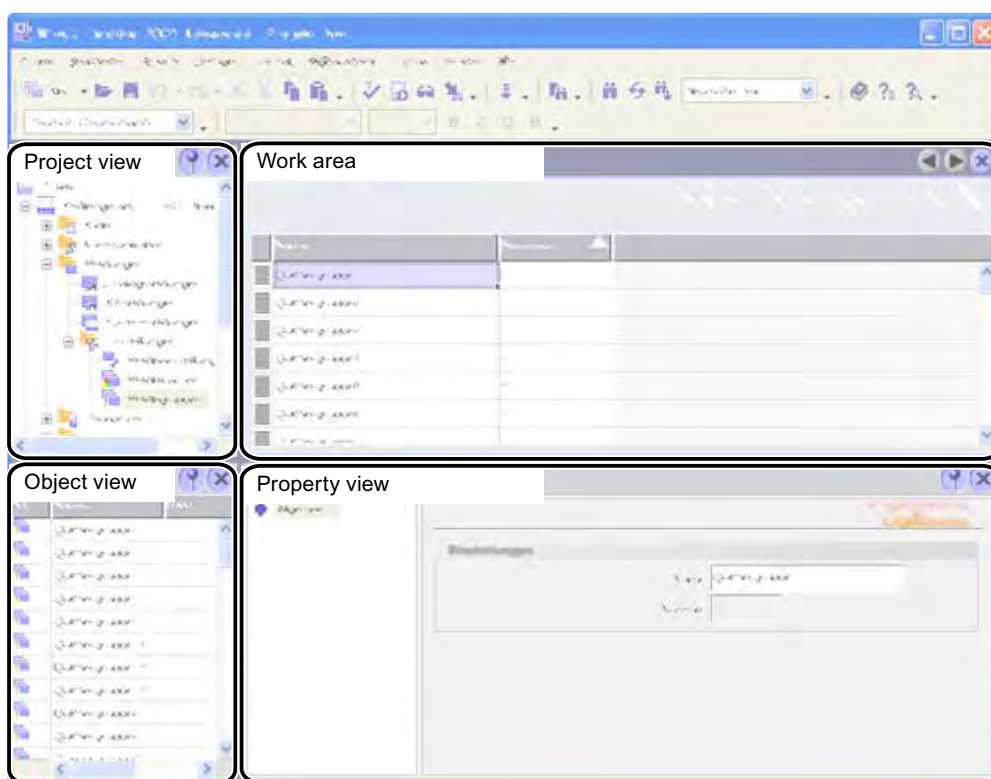

Work area

The work area shows in tabular form all the established alarm groups and the associated settings. You can edit the properties of the alarm groups in the table cells.

Property view

The name of the alarm group is modified in the property view. The alarm group number is assigned by the system.

6.2.2.7 Basic Settings for the Alarm System

Introduction

The WinCC flexible alarm system is functional using the default settings. You change these default settings if you want to adapt the alarm system behavior to specific plant conditions.

Open

In the project view, double-click "Alarm settings" in the "Alarms > Settings" group.

Layout

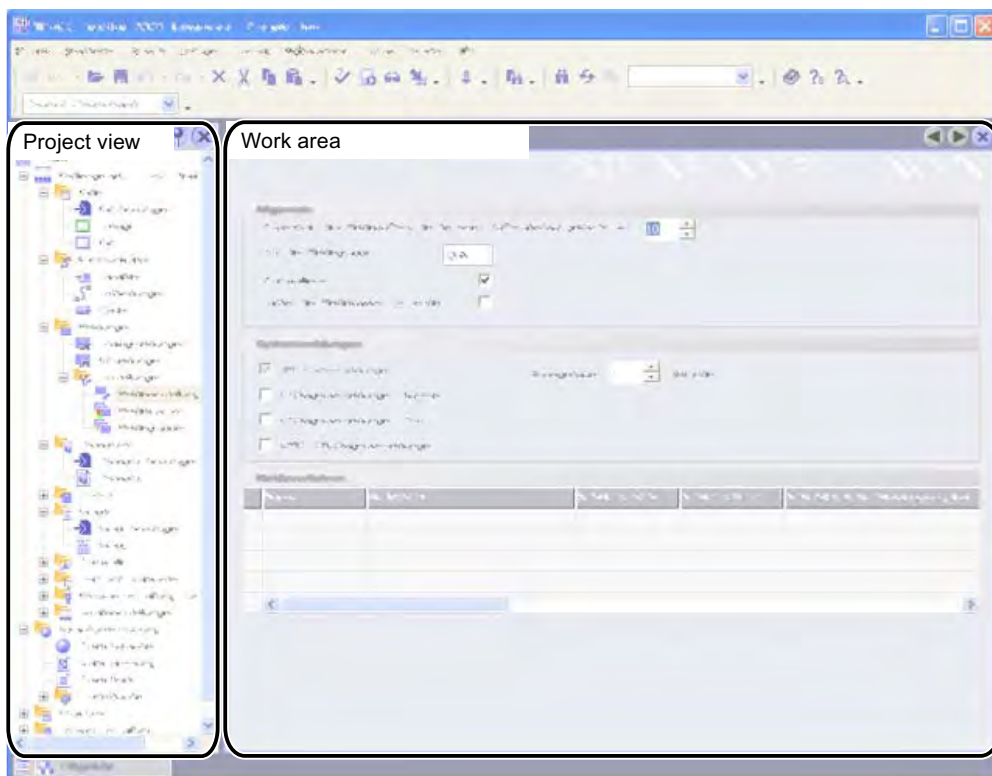

Work area

You define the settings for the alarm system in the work area. In the "System alarms" area you select, for example, the types of system alarms to be displayed on the HMI device. In integrated operation further settings can be defined in the "Alarm procedures" area.

6.3 Working with alarms

6.3.1 Reporting alarms

Introduction

You configure a report in WinCC flexible with which you can output the following alarms:

- Current alarms from the alarm buffer
- Alarm from an alarm log

Procedure

Proceed as follows:

1. Add the "Print alarm" from the toolbox object to a report.
2. Select the object in order to have the properties displayed in the property view.
3. Establish from the property view the data that is to be configured.
4. Specify the alarm classes which you want to output for the selected source.
5. Specify the sequence of the alarms for the output.
6. To output the alarms of a certain interval, select the respective tags for the "Display beginning" and "Display end" fields. The tags can be supplied in runtime with the date and time for the first or the last alarm of the period.

6.3.2 Integrating alarms with the alarm numbering procedure

Configuring in SIMATIC STEP 7

ALARM_S and ALARM_D are alarm numbering procedures. Alarm numbers are assigned automatically during STEP 7 configuration. These numbers are used to uniquely assign alarm messages.

During alarm configuration in STEP 7, the stored alarms and attributes are placed in the STEP 7 configuration data. WinCC flexible automatically imports the required data and transfers them later to the HMI device.

You filter the output of ALARM_S alarms WinCC flexible by means of display classes. In the project view select "Alarms ► Settings" and double-click the "Alarm settings". The existing connections are displayed in the "Alarm Procedures" area.

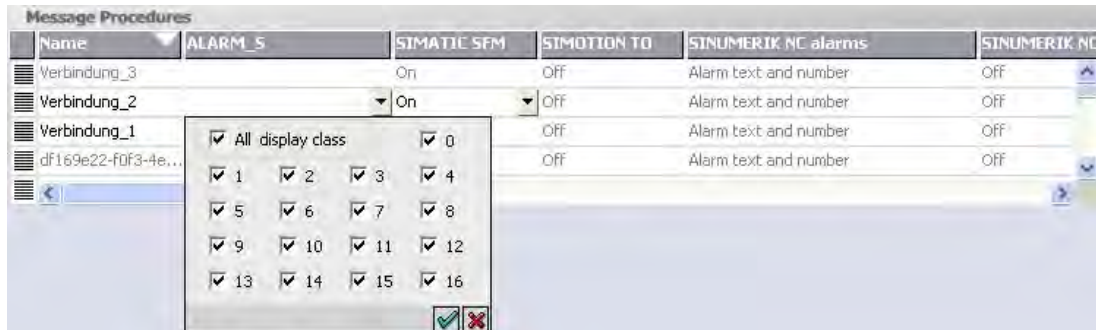

In the row of the required connection, select the field in the "ALARM_S Display Classes" column and open the selection dialog by pressing the selection button. Select the required display class. Close the selection dialog by pressing the  button.

In the "SFM Alarms" column of a link, specify whether system errors should be displayed. For more information, consult the STEP 7 documentation.

Maximum number of ALARM_S alarms

The maximum number of ALARM_S alarms in WinCC flexible is 32767. In practice, the maximum number of configurable alarms is limited by the memory available on the HMI device.

Alarm class layout

The ALARM_S and ALARM_D alarms are assigned to particular alarm classes in STEP 7. To edit the display options for these alarm classes, select "Alarms ► Settings ► Alarm Classes". in the WinCC flexible project window. Open the shortcut menu and select the "Open Editor" command. You can recognize alarm classes by the S7 prefix in the alarm class name.

Name	Acknowledgment	Log	I color	IO color	IA color	IOA color
S7Alarm	On "Incoming"	<No log>	Red	Orange	Yellow	Green
S7NoAlarm	Off	<No log>	Magenta	Cyan		
S7OperationMessage	Off	<No log>				
S7OperatorInputRequest	Off	<No log>				
S7ProcessControlMaintenance	Off	<No log>				
S7ProcessControlSystemMessageOs	Off	<No log>				
S7ProcessControlSystemMessagePlc	Off	<No log>				
S7ProcessMessageAlarm	On "Incoming"	<No log>				
S7ProcessMessageEvent	Off	<No log>				
S7StatusMessage	On "Incoming"	<No log>				
S7Tolerance	Off	<No log>				
S7Warning	Off	<No log>				

You configure the display options for the alarm classes using the "Alarm Classes" editor.

Implementing Alarm_S alarms of SIMOTION

Alarm_S alarms are also available in SIMOTION. Configure the Alarm_S alarms in SIMOTION SCOUT using the "Alarm configuration" editor.

WinCC flexible processes the Alarm_S alarms of SIMOTION similar to Alarm_S alarms of STEP 7.

You filter the output of ALARM_S alarms WinCC flexible by means of display classes. In the project view select "Alarms ► Settings" and double-click the "Alarm settings". The existing connections are displayed in the "Alarm Procedures" area.

Name	ALARM_S	SIMATIC SFM	SIMOTION TO	SINUMERIK NC alarms	SINUMERIK NC
Verbindung_3		On	OFF	Alarm text and number	OFF
Verbindung_2		On	OFF	Alarm text and number	OFF
Verbindung_1			OFF	Alarm text and number	OFF
df169e22-f0f3-4e...			OFF	Alarm text and number	OFF

Selection dialog for ALARM_S Display Classes:

All display class

0 1 2 3 4

5 6 7 8

9 10 11 12

13 14 15 16

OK Cancel

Select the field from the "ALARM_S Display Classes" column and the row which contains the connection to the SIMOTION device. Open the selection dialog box by pressing the selection button. Select the required display class. Close the selection dialog by pressing the button.

Go to the "TO Alarms" column of the connection and define whether to display the process alarms of SIMOTION. For further information, refer to the SIMOTION documentation.

The representation of the alarm classes is configured similar to the alarm classes of Alarm_S alarms of STEP 7.

6.4 Alarm logging

6.4.1 Basic principles of alarm logging

Introduction

Alarms indicate fault states and operating states of a process in a project. They are generally triggered by the PLC and displayed in a screen on the HMI device.

WinCC flexible lets you log alarms and document operational states and error states of the plant.

Note

Archiving is not available on all devices.

Principle

You can configure alarm logging. The alarms to be logged are assigned to an alarm log via the alarm class. Every message belongs to a specific alarm class. You assign the alarm log that is to be used when configuring an alarm class.

In doing so, a log can include alarms of several alarm classes. When you create a log, you specify the log properties and select the log behavior. The log records the following data of each logged alarm:

- Date and time of alarm
- Alarm text
- Alarm number
- Alarm status
- Alarm class
- Alarm procedure
- Values in the tags contained in the alarm text
- Controller

Note

The alarm text and controller are only logged if this has been configured in the properties of a log.

6.4.2 Alarm logging

Introduction

To log alarms, you group them in alarm classes. Each alarm class can be recorded in a separate log. Depending on the HMI device, you can select a log type when making configuration settings. You specify the log behavior when configuring the log.

Log types

In WinCC flexible, you can select from the following log types:

1. Circular log
2. Segmented circular log
3. Log with level-dependent system alarm
4. Log with level-dependent execution of system functions

Alarms can be logged automatically or managed by an operator.

Storage media

Log data can be saved either in a file or in a database. Saved data can undergo additional processing in other programs, e.g. for analysis purposes.

Displaying log contents

You display log contents on the HMI device. To do so, you must configure an alarm view.

6.4.3 "Alarm logs" editor

Introduction

In the "Alarm logs" table editor, you configure alarm logs for logging alarm classes and define their properties.

Open

Double-click on "Alarm logs" in the project window in the "Log" group to open the "Alarm log" editor.

Structure

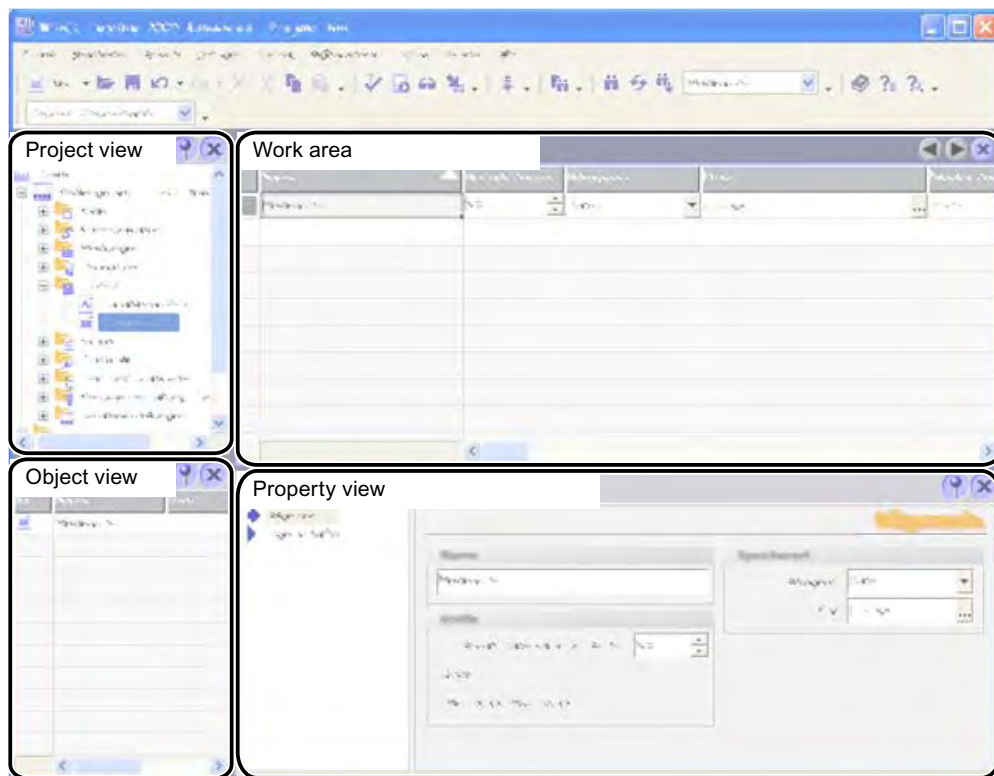

Work area

All alarm logs are displayed in a table in the work area. You can edit the properties of the alarm logs in the table cells.

6.4.4 Basic settings for alarm logs

Introduction

The properties of an alarm log are specified in the "Alarm log" editor.

General properties

The following general properties can be established for alarm logs:

- Name

The name of the alarm log must include at least one letter or one number.

Note

The characters which can be used in the name of the data source depend on the storage location.

- The following characters may not be used for the storage location "File - RDB" or "File - CSV (ASCII)": \ / * ? : " < > |
- If the storage location "Database" is used, the following characters may not be used: a-z A-Z 0-9 _ @ # \$
However, the characters _ @ # \$ may not be used as the first character of the name.

- Storage location

The alarm log is saved to an ODBC database (only on a PC) or to a separate file. Select "Database" or a file accordingly as the storage location.

Depending on the configuration of the HMI device, you can specify the following as the "path":

- The local hard disk of the PC
- The storage card of the panel
- If available, a network drive

If you choose an ODBC database as a storage location, you have the following possibilities for the names of the data source:

- "System-defined data source name", if you want the name to be assigned by the system.

Note

Under Windows VISTA, databases with the option "System-defined data source" are not supported.

You can only use databases with the option "User-defined data source." As administrator, you must have created these databases and released them on the PC.

Refer to the documentation of your database software for details.

You will also need on the target system a special instance of the Microsoft SQL server. For this, download the freely available SQL Server 2005 Express for example.

This setting is not available on the Panel PC 477.

- "User-defined data source name", if you want to assign the name of the data source yourself.

- Size

The size of the log is calculated from the number of data records and the rough size of an entry. The size of an entry is dependent, amongst other things, on whether the alarm text and associated tag values which are also to be logged.

Alarm log properties

The following general properties can be established for alarm logs:

- Start-up behavior

Under Enable you can specify that logging starts when runtime is started. Enable "Enable logging at runtime start."

You can also control the behavior at runtime start in other ways:

- In order to overwrite already enabled data with the new data, enable "Reset log".
- In order to add logged data to an existing log, enable "Continue log".

Note

System functions can be used to control the restart of a log during runtime.

- Logging method

Here you can specify what should happen when the log is full. You can choose one of the following options:

- Circular log
When the log is full, the oldest entry will be overwritten.
- Segmented circular log
Multiple logs of the same size will be created and filled one after the other. When all logs are completely full, the oldest log is overwritten.
- Display system alarms with
If a defined level is reached, a system alarm is shown.
- Trigger event
The "Overflow" event is triggered as soon as the log is full.

- Settings

Define whether the alarm text and error location should be stored each time an alarm is logged. The alarm texts will be logged in the current runtime language.

- Comment

Here you can enter descriptive text regarding the log.

6.4.5 Alarm logging

Introduction

In runtime, alarms can be stored in logs for later evaluation. You must specify the following in order to log alarms of an alarm class:

- In which log the alarms are to be saved
- Whether the associate alarm text and tag values are also to be saved

Principle

The following steps are necessary for alarm logging:

- Creating and configuring alarm logs

When creating an alarm log, the following must be defined:

- General settings, e.g. name, size, storage location
- Behavior at runtime start
- Behavior when the log is full

- Configuring logging of the alarms in an alarm class

You can specify an alarm log for each alarm class in which the alarm events are stored during runtime.

- Further processing logged alarms

You can evaluate the logged alarms directly in your WinCC flexible project, e.g. in an alarm view, or via another application, e.g. Excel.

Note

The sequence of tag fields in the alarm text is language dependent. The sequence of Runtime language is used for logging alarms in a csv-log.

Changing the tag of a tag field in one language causes the modified tag field to appear at the end of the alarm text in all other languages. As a result, the sequence of the tag fields can change unexpectedly in the log file.

6.4.6 Displaying logged alarms on screens

Introduction

During runtime, you can display logged alarms on the screens of the HMI device. During this process, alarms in an alarm class are downloaded from the log database and presented in an alarm view.

Principle

You must configure an alarm view to display logged alarms on the HMI device. When configuring an alarm view, specify the alarm class of the alarms to be displayed.

6.4.7 Structure of a *.csv file with alarms

Introduction

You can save an alarm log as a CSV file. CSV stands for Comma Separated Value. In this format the table columns that contain the names and the value of the entry are separated by semicolons. Each table row ends with a carriage return.

Example of a *.csv file

This example shows a file with logged alarms:

```
"Time_ms";"MsgProc";"StateAfter";"MsgClass";"MsgNumber";"Var1";...;"
Var8";"TimeString";"MsgText";"PLC"37986550590,27;1;1;3;110001;"";...
;"";"30.06.99 13:12:51";"Change to operating mode
'online'";37986550682,87;1;1;3;140010;"";...;"";"30.06.99
13:12:59";"Connection established: PLC_1, Station 2, Rack 0,
Position 2";
```

Structure of a log file in *.csv format

The following values are entered in the individual columns of a WinCC flexible log file:

Parameter	Description
Time_ms	Specify a time stamp as a decimal value (see below for conversion)
Msg_Proc	Alarm procedures: 0 = Unknown alarm procedure 1 = System alarm 2 = Alarm bit procedure (operating alarms) 3 = Alarm number procedure ALARM_S 4 = Diagnostic event 7 = Analog alarm procedure 100 = Alarm bit procedure (fault alarms)
State after	Alarm event: 0 = Arrived/Departed 1 = Arrived 2 = Arrived/Acknowledged/Departed 3 = Arrived/Acknowledged 6 = Arrived/Departed/Acknowledged
Msg_Class	Alarm class 0 = No alarm classes 1 = "Interruption" 2 = "Operation" 3 = "System" 64 ... = User configured alarm classes
Msg Number	Alarm number
Var1 to Var8	Alarm tag value as STRING
Time string	Time stamp as STRING, i.e., readable date format
Msg text	Alarm in a readable STRING
PLC	Alarm localization (relevant PLC)

Conversion of the time stamp decimal value

If the value needs to be processed using a different program, proceed as follows:

1. Divide Time_ms by 1,000,000.

Example: $37986476928 : 1.000.000 = 37986,476928$

2. The whole number portion (37986) is the date calculated from 31.12.1899.

In Excel you can now convert the time stamp into days. To do this, assign to the cell that contains the time stamp, a respective format from the "Date" group.

Result: 37986 results in 31.12.2003

3. The value after the comma (0,476928) indicates the time:

- Multiply the value (0.476928) by 24 to obtain the hours (11.446272).
- Multiply the remainder (0.446272) by 60 results in the minutes (26.77632).
- Multiply the remainder (0.77632) by 60 results in the seconds (46.5792).

Sum 11:26:46.579

This conversion is supported by Microsoft Excel, for example.

6.4.8 Accessing the ODBC log database directly

Introduction

The storage location of a log can be a database or a file.

The database is addressed by means of its "Data source name" (DSN). Select the database you would like to use in WinCC flexible in the Windows Start menu under Settings > Control panel > ODBC data sources.

To store log data, specify the "Data source name" (DSN) instead of a directory name when making your configuration settings. With the DSN, you are referencing the database and the storage location.

Application

The entire functional scope of the database is available for additional processing and evaluation of log data.

Principle

You create the data source that connects to the database on the same computer that contains the runtime software. You then specify the DSN configured here when you create a log in WinCC flexible.

Using the ODBC interface, you can access the database directly with other programs, such as the MS SQL server.

With the "StartProgram" system function, you can also configure a program call on the HMI device. This does not interrupt the runtime program sequence.

Working with a connection

7.1 Basics

7.1.1 Communication basics

Introduction

The data exchange between two communication partners is known as communication. The communication partners can be interconnected via direct cable connection or network.

Communication partners

A communication partner can be any node which is capable of communicating and exchanging data with other nodes on the network. In the WinCC flexible environment, the following nodes can be communication partners:

- Central modules and communication modules in the automation system
- can be HMI devices and communication processors in the PC.

Data transferred between the communication partners may serve different purposes:

- process control
- process data acquisition
- reporting states in a process
- process data logging

7.1.2 Principles of communication

Introduction

WinCC flexible controls communication between the HMI and the PLC by means of tags and area pointers.

Communication using tags

In WinCC flexible, tags are centrally managed in the "Tag" editor. There are external and internal tags. External tags are used for communication, and represent the image of defined memory locations on the PLC. The HMI and the PLC both have read and write access to this storage location. Those read and write operations may cyclic or event-triggered.

In your configuration, create tags that point to specific PLC addresses. The HMI reads the value from the defined address, and then displays it. The operator may also enter values on the HMI device which will be written to the relevant PLC address.

Communication using area pointers

Area pointers are used to exchange data of specific user data areas. Area pointers are parameter fields. WinCC flexible receives from these parameter fields in runtime the information about the location and size of data areas in the PLC. During communication, the PLC and the HMI device alternately access those data areas for read and write operations. Based on the evaluation of data stored in the data areas, the PLC and HMI device trigger defined actions.

WinCC flexible uses the following area pointers:

- Control request
- Project ID
- Screen number
- Data record
- Date/time
- Date/time PLC
- Coordination

The availability of the various area pointers is determined by the HMI used.

Communication between WinCC flexible and automation systems

Industrial communication using WinCC flexible means that data are exchanged using tags and area pointers. To acquire the data, the HMI sends request messages to the automation system using a communication driver. The automation system (AS) returns the requested data to the HMI in a response frame.

Communication drivers

A communication driver is a software component that develops a connection between an automation system and an HMI device. The communication driver hence enables the tags in WinCC flexible to be supplied with process values. WinCC flexible supports the interconnection of different automation systems with various communication drivers.

Users can select the interface, the profile and the transmission speed for each specific communication partner.

Communication between HMIs

The SIMATIC HMI HTTP Protocol is available for the communication between HMIs. This protocol is a component of the "Sm@rtAccess" option. The protocol can be used on PCs with WinCC flexible Runtime and on Panels as of the 270 series. For detailed information, refer to the SIMATIC HMI HTTP Protocol documentation.

Communication via uniform and manufacturer-independent interface

WinCC flexible provides a uniform and manufacturer-independent software interface using OPC (OLE for Process Control). This interface allows a standardized data exchange between applications for industry, office, and production. For detailed information, refer to the OPC documentation.

7.2 Elements and basic settings

7.2.1 Connections Editor

Introduction

In the "Connections" editor, you create and configure connections.

Open

Select "Connections" from the project view, and then open the shortcut menu. Select "New connection" from in this shortcut menu. The new connection will be created and opened in the work area.

Structure

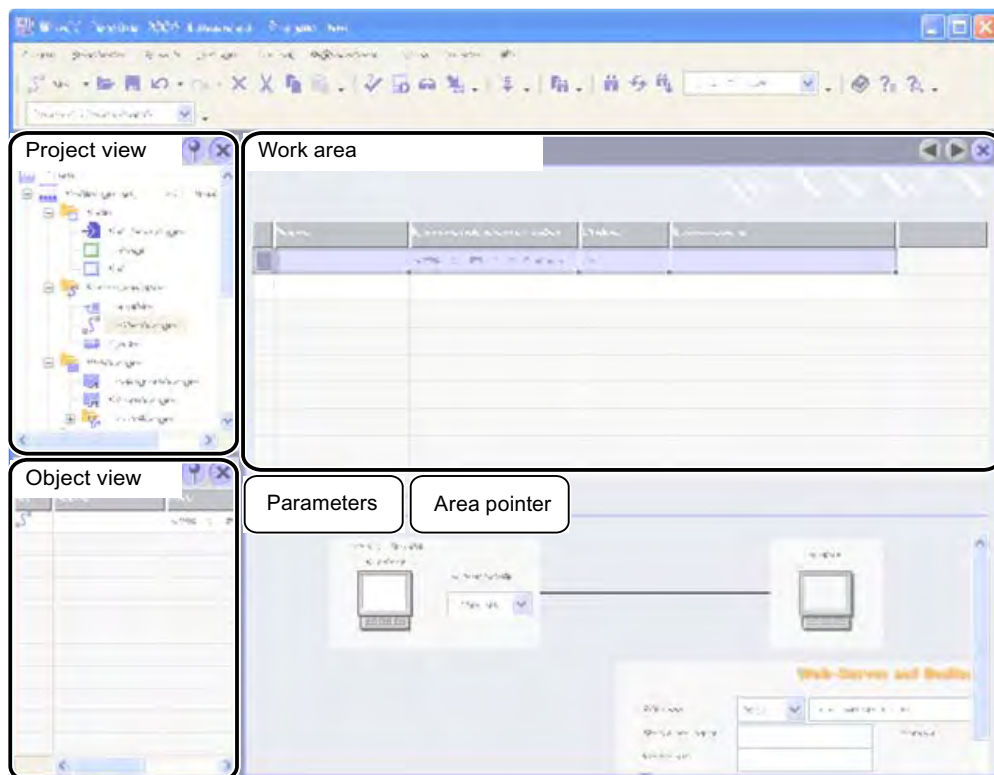

Menu bar

The menu bar contains all commands required for operating WinCC flexible. Available key combinations are indicated next to the menu command.

Toolbars

The toolbars contain the most frequently used buttons.

Select "View > Toolbars" to show or hide the specific toolbars. The  button of a toolbar can be used to show or hide specific buttons of this toolbar.

Work area

All connections are visualized in the work area in tabular format. You select the communication drivers from the table cells, and edit the relevant connection properties. To sort the table by its column entries, simply click the column header.

"Parameters" tab

Using the "Parameters" tab you can configure the settings for the communication drivers selected in the table. Select the settings for the HMI, the network and for the PLC.

"Area pointer" tab

Using the "Area pointers" tab you can configure the area pointers of the connections.

7.2.2 Parameters for connections

Introduction

Select the "Parameters" tab of the "Connections" editor to configure the properties of a connection between the HMI and the communication partner.

Structure

The communication partners are visualized schematically on the "Parameters" tab. This tab provides the "HMI device", "Network" and "PLC" areas where you can declare the parameters of the relevant interface used.



The system sets default parameters. Always ensure consistency on the network whenever you edit parameters. For detailed information on configurable parameters, refer to the description of the supported protocols.

7.2.3 Area pointers for connections

Introduction

Using the "Area pointer" tab of the "Connections" editor, you can configure the usage of the available area pointers.

Structure

The "Area pointer" tab contains two tables of area pointers. The "For all connections" table contains those area pointers which are created only once in the project and can be used for only one connection.

The "For each connection" table contains the area pointers you can set separately for each available connection.

Parameters						
Area pointer						
For all connections						
Connection	Name	Address	Length	Trigger mode	Acquisition cycle	Comment
Connection_1	Data/time PLC	DB 1 DBW 0	5	Cyclic continuous	1 min	
<undefined>	Project ID		1	Cyclic continuous	<undefined>	
<undefined>	Screen number		5	Cyclic continuous	<undefined>	
For each connection						
Active	Name	Address	Length	Trigger mode	Acquisition cycle	Comment
On	Coordination	DB 1 DBW 12	2	Cyclic continuous	<undefined>	
Off	Data mailbox		5	Cyclic continuous	<undefined>	
Off	Date/time		6	Cyclic continuous	<undefined>	
Off	Job mailbox		4	Cyclic continuous	<undefined>	

The availability of the various area pointers is determined by the HMI device used. For detailed information on area pointers and their configuration, refer to the description of the supported protocols.

7.3 Connection and Protocols

HMI functionality

The HMI is used to read, save and record alarms and tags. In addition, the HMI can be used to intervene in the process.



CAUTION

Ethernet communication

In Ethernet-based communication, such as PROFINET IO, HTTP, Sm@rtAccess, Sm@rtService and OPC, it is the end user who is responsible for the security of his data network. The proper functioning of the device cannot be guaranteed in all circumstances; targeted attacks, for example, can lead to an overloading of the device.

Data exchange

The prerequisite for the operating and monitoring functions is the connection of the HMI device to a PLC. Data exchange between the HMI and the PLC is controlled by a connection-specific protocol. Each connection requires a separate protocol.

Criteria for selecting the connection

Criteria for selecting the connection between the HMI and the PLC are, for example:

- PLC type
- CPU in the PLC
- HMI device type
- Number of HMI devices per PLC
- Structure and any bus systems of an existing plant
- Amount of components additionally required

Protocols

Protocols are available for the following PLCs:

PLC	Protocol
SIMATIC S7	<ul style="list-style-type: none"> • PPI • MPI ¹⁾ • PROFIBUS DP • TCP/IP (Ethernet)
SIMATIC S5	<ul style="list-style-type: none"> • AS 511 • PROFIBUS DP
SIMATIC 500/505	<ul style="list-style-type: none"> • NITP • PROFIBUS DP
SIMATIC HMI HTTP Protocol	<ul style="list-style-type: none"> • HTTP/HTTPS (Ethernet)
SIMOTION	<ul style="list-style-type: none"> • MPI • PROFIBUS DP • TCP/IP (Ethernet)
OPC	<ul style="list-style-type: none"> • DCOM
Allen-Bradley	<p>PLC series SLC500, SLC501, SLC502, SLC503, SLC504, SLC505, MicroLogix and PLC5/11, PLC5/20, PLC5/30, PLC5/40, PLC5/60, PLC5/80</p> <ul style="list-style-type: none"> • DF1 ²⁾ • DH+ via KF2 module ³⁾ • DH485 via KF3 module ⁴⁾ • DH485 ⁴⁾ <p>PLC series ControlLogix 5500 (with 1756-ENBT) and CompactLogix 5300 (1769-L32E and 1769-L35E)</p> <ul style="list-style-type: none"> • Ethernet
GE Fanuc Automation	<p>SPS series 90–30, 90–70, VersaMax Micro</p> <ul style="list-style-type: none"> • SNP
LG Industrial Systems (Lucky Goldstar) / IMO	<p>PLC series GLOFA GM (GM4, GM6 and GM7) / Series G4, G6 and G7</p> <ul style="list-style-type: none"> • Dedicated communication
Mitsubishi Electric	<p>PLC series MELSEC FX and MELSEC FX0</p> <ul style="list-style-type: none"> • FX (Mitsubishi PG)
Mitsubishi Electric	<p>PLC series MELSEC FX0, FX1n, FX2n, AnA, AnN, AnS, AnU, QnA and QnAS</p> <ul style="list-style-type: none"> • Protocol 4
OMRON	<p>PLC series SYSMAC C, SYSMAC CV, SYSMAC CS1, SYSMAC alpha, CJ and CP</p> <ul style="list-style-type: none"> • Hostlink/Multilink (SYSMAC Way)
Modicon (Schneider Automation)	<p>PLC series Modicon 984, TSX Quantum and TSX Compact</p> <ul style="list-style-type: none"> • Modbus RTU <p>SPS series Quantum, Momentum, Premium and Micro</p> <p>SPS series Compact and 984 via Ethernet bridge</p> <ul style="list-style-type: none"> • Modbus TCP/IP (Ethernet)

PLC	Protocol
Telemecanique	PLC series TSX 7 with P47 411, TSX 7 with P47/67/87/107 420, TSX 7 with P47/67/87/107 425, module TSX SCM 21.6 with the specified TSX 7 CPUs, TSX 17 with module SCG 1161, TSX 37 (Micro), TSX 57 (Premium) <ul style="list-style-type: none">• Uni-Telway

- 1) Not possible when connected to S7-212.
- 2) Applies to controllers SLC503, SLC504, SLC505, PLC5, MicroLogix
- 3) Applies to controllers SLC504, PLC5 over DF1
- 4) Applies to controllers SLC500 to SLC 505 and MicroLogix

7.4 Ethernet connection

Port Addresses

 CAUTION Ethernet communication In Ethernet-based communication, such as PROFINET IO, HTTP, Sm@rtAccess, Sm@rtService and OPC, it is the end user who is responsible for the security of his data network. The proper functioning of the device cannot be guaranteed in all circumstances; targeted attacks, for example, can lead to an overloading of the device.
--

NOTICE Verify that local and remote port settings are identical.
--

When connecting via Ethernet, you require the port addresses to, for example, configure a firewall, or a router.

	Port address TCP/IP	Port address UDP
S7 Communication	102	
HTTP (communication; transfer)	80	
HTTPS (communication; transfer)	443	
SmartServer (via Browser Control)	80, 5800, 5900	
SmartServer (via SmartViewer)	5900	
SmartServer (via Internet Explorer)	5800, 59	
MiniWeb (HTML Pages via Browser Control)	80 HTTP 443 HTTPS	
MiniWeb (HTML Pages via Internet Explorer)	80 HTTP 443 HTTPS	
MiniWeb (HTML Pages using internal Pocket Explorer)	80 HTTP 443 HTTPS	
WebServices (SOAP)	80 HTTP 443 HTTPS	
OPC-XML (CE as OPC Master)	80 HTTP 443 HTTPS	
OPC DCOM		
SendEmail	25	
Transfer (via Ethernet; CE-Stub; PC Loader; PC)	2308 alternative 50523	
Logging (via Ethernet) CSV File	139, 445	137, 138
Logging (via Ethernet) database		

7.5 SNMP and MIB on HMIs

SNMP

The SNMP (Simple Network Management Protocol) is the Internet standard protocol for monitoring network components or also end devices, e.g. HMI devices. SNMP is part of the TCP/IP protocol suite and works in accordance with the client / server model.

SNMP was developed by the Internet Engineering Task Force (IETF). HMI devices support version 1 (SNMPv1) and community-based SNMP Version 2 (SNMPv2c).

HMI devices have SNMP agents. The SNMP agents give information about the device configuration. This information is managed in a data structure, the Management Information Base (MIB).

MIB

The MIB is a standardized data structure made up of different SNMP tags. The devices use MIB II (RFC1213).

The "public" community is supported for the reading and writing of SNMP tags on HMI devices.

Points to note with device names:

The device name used under MIB II is not the PROFINET IO name, but rather the device name used in the network.

The device name is entered in the "Communications" dialog of the control panel and should not exceed 15 characters. If you enter a longer name via SNMP in the MIB II database, the device name in the control panel of the device will be reset to "WinCE".

Structure of a recipe management system

8.1 Basics

8.1.1 Basic principles of recipes

Introduction

Recipes are a collection of data that belongs together, e.g. machine parameter settings or production data.

Examples:

- Machine parameter settings that are needed to convert production to a different product variant.
- Product components that result in different compositions for different end products.

A recipe has a fixed data structure. The structure of a recipe is defined once at the configuration stage. A recipe contains recipe data records. These differ in terms of their values, but not their structure. Recipes are stored on the HMI device or on an external storage medium. If, for example, production data is stored on a server in a database, you can import the production data via a CSV file at runtime.

A recipe data record is generally transferred in full between the HMI device and PLC in a single step.

Using recipes

Recipes can be used in the following situations:

- **Manual production**
You select the required recipe data and display it on the HMI device. You modify the recipe data as required and save it on the HMI device. You transfer the recipe data to the PLC.
- **Automatic production**
The control program starts transfer of the recipe data between the PLC and HMI device. You can also start the transfer from the HMI device. Production is then implemented automatically. It is not essential to display or modify the data.
- **Teach-in mode**
You optimize production data that was optimized manually on the system, e.g. axis positions or filling volumes. The values thus determined are transferred to the HMI device and saved in a recipe data record. You can then transfer the saved recipe data back to the PLC at a later date.

Displaying recipes

The recipes can be displayed and edited on the HMI device in the following ways:

- A recipe view within a process picture
- A recipe screen

Entering and modifying the recipe data

You enter the data in the individual recipe data records and modify it as required. The following options are available:

- Data entry during configuration

If the production data exists already, you can enter the data in the "Recipes" editor during recipe configuration.

- Data entry during runtime

If you have to frequently modify production data, you can do this directly at runtime.

- Enter the data directly on the HMI device.
- Set the parameters directly on the machine. You then transfer the data from the PLC to the HMI device and save it in the recipe.

8.1.2 Example for using recipes

Recipes are used in the manufacturing industry and mechanical engineering, for example. The two examples illustrate typical applications that you can implement with the recipe functionality of the WinCC flexible engineering system:

- Machine parameter assignment

One field of application for recipes is the assignment of machine parameters in the manufacturing industry: A machine cuts wooden boards of various sizes to specified dimensions and drills holes. The guide rails and drill have to be moved to new positions according to the board size. The required position data are stored as data records in a recipe. You reassign the machine parameters using "Teach in" mode if, for example, a new board size is to be processed. You transfer the new position data directly from the PLC to the HMI device and save it as a new data record.

- Batch production

Batch production in the food processing industry represents another field of application for recipes: A filling station in a fruit juice plant produces juice, nectar, and fruit drinks in a variety of flavors. The ingredients are always the same, differing only in their mixing ratios. Each flavor corresponds to a recipe. Each mixing ratio corresponds to a data record. All of the required data for a mixing ratio can be transferred to the machine control at the touch of a button.

8.1.3 Structure of recipes

Introduction

The basic structure of a recipe is illustrated with reference to a filling station in a fruit juice plant.

There may be several different recipes in an HMI device. A recipe can be compared to an index card box that contains several index cards. The index card box contains several variants for manufacturing a product family. The full data for each manufacturing variant is contained on a single index card.

Example:

In a soft drinks production plant, a recipe is needed for different flavors. Drink variants include fruit juice drink, juice and nectar.

Recipe

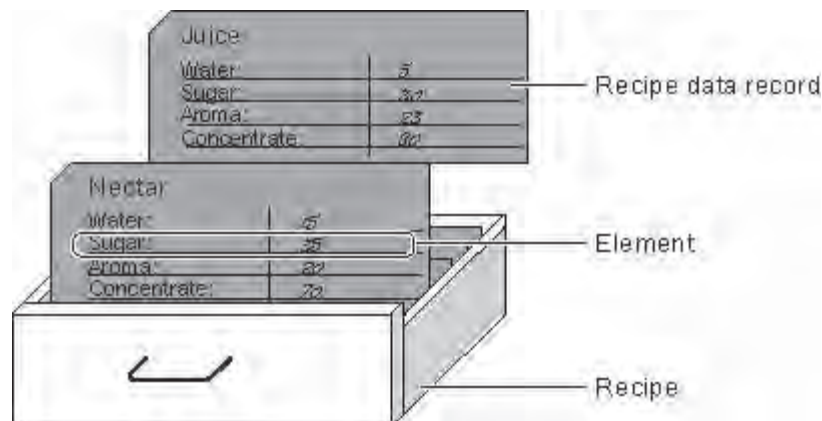

Recipe data records

Each index card represents a recipe data record needed to manufacture a product variant.

Recipe entries

Each index card in a drawer is printed immediately. All the index cards contain fields for the different ingredients. Each field corresponds to a recipe entry. All the records of a recipe thus contain the same entries. The records differ, however, in the value of the individual entries.

Example:

All drinks contain the same components:

- Water
- Concentrate
- Sugar
- Flavoring

The records for juice drink, fruit juice or nectar differ, however, in the quantity of sugar used in production.

8.1.4 Display of recipes

Introduction

Recipes can be displayed in the following ways:

- Recipe view
- Recipe screen

Input in the recipe view and recipe screen

You can change the values of a recipe in the recipe screen or recipe view and thus modify the manufacturing process or a machine.

The recipe view and recipe screen can perform the same functions when using recipes. They differ in the following respects:

- Display options
- Operation
- Possibility of transferring data between the PLC and the HMI device

Recipe view

The recipe view is suitable for viewing simple recipes.

The recipe view is an off-the-shelf WinCC flexible screen object for managing recipe data records. The recipe view is always part of a process picture. The recipe view shows recipe data records in tabular form. The display and possible operations are adapted to individual needs.

If you are editing recipes with a recipe view in your project, the values are saved in recipe data records. The values are not transferred between the HMI device and PLC until you use the relevant operating element.

Recipe screen

The recipe screen is an individual plant display that contains:

- Input fields for recipe variables
- Control objects for using the recipes, e.g. "SaveDataRecord"

The recipe screen is suitable in the following situations:

- Large recipes
- Allocation of recipe fields to the graphic display of the relevant plant unit
- Breakdown of the recipe data into several process pictures

Note

The values of recipe variables are transferred between the PLC and recipe screen at the following times depending on the configuration:

- Immediately after modification
 - When a relevant operating element is used
-

Synchronization between the recipe view and recipe screen

Differences may occur during runtime between the values displayed in the recipe view and the values saved in the associated tags when you edit recipes with a recipe view and in a recipe screen. To prevent this, the recipe data record values must be synchronized with the values of the recipe tags.

It is always a complete recipe data record that is saved or synchronized.

Note

Recipe tags can only be synchronized in the enhanced recipe view. Synchronization only takes place if the "Synchronize tags" setting is enabled for the recipe.

8.1.5 Transfer of recipe data records

Flow of data in recipes

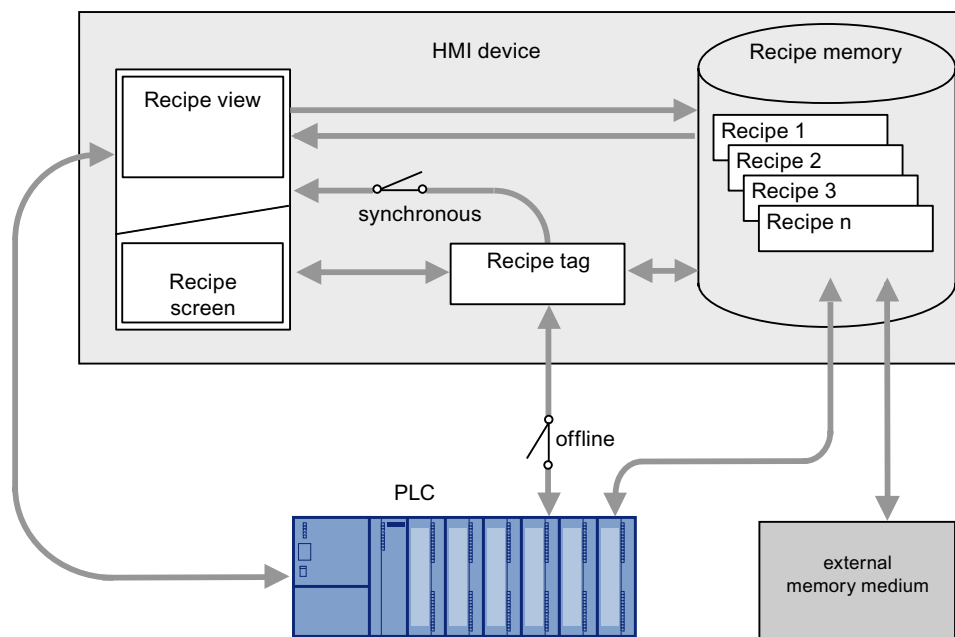

Interaction between the components

There is interaction between the following components at runtime:

- Recipe view / recipe screen

On the HMI device, recipes are displayed and edited in the recipe view or in a recipe screen.

- The recipe data records from the internal memory of the HMI device are displayed and edited in the recipe view.
- The values of the recipe tags are displayed and edited in the recipe screen.

Depending on the configuration, the values displayed in the recipe view are synchronized with the values of recipe tags.

- HMI device recipe memory

Recipes are saved in the form of recipe data records in the HMI device's recipe memory.

- Recipe tags

The recipe tags contain recipe data. When you edit recipes in a recipe screen, the recipe values are stored in recipe tags. The point at which the values of the recipe tags are exchanged with the PLC depends on the configuration.

Note

You can synchronize the recipe tags with the recipe data records so that the same values are saved in both.

Loading and saving recipe data

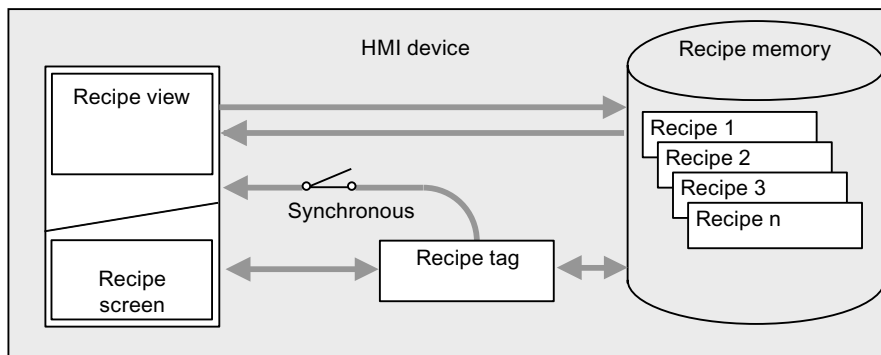

Complete recipe data records are loaded from or saved to the recipe memory on the HMI device in the recipe view.

The values of the recipe data record are loaded from the recipe memory to the recipe tags in the recipe screen. When they are saved, the values of the recipe tags are saved to a recipe data record in the recipe memory.

Transferring the recipe values between the HMI device and the PLC

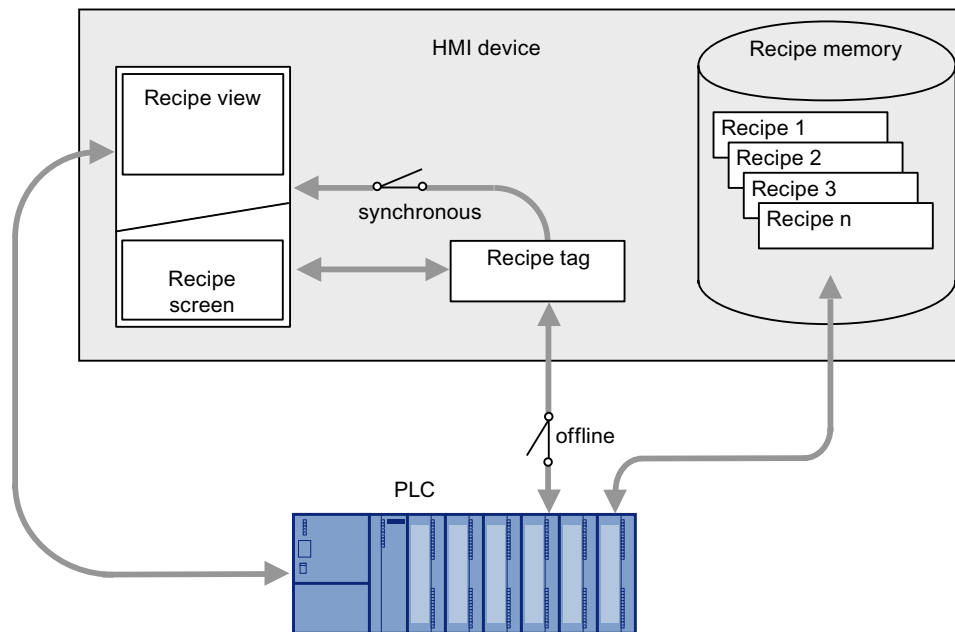

Complete recipe data records are transferred between the recipe view and PLC.

The following transfers are possible between the recipe screen and PLC, depending on the configuration:

- Transferring recipe data records between PLC and recipe tags
- Immediate transfer of individual modified values between the PLC and recipe tags.
The following settings are needed in the recipe in order to do this:
 - "Synchronize tags" has been enabled.
 - "Tags offline" has been deactivated.

Recipe data records can be transferred directly between the HMI device and PLC. In these situations, the display on the HMI device is not essential.

Exporting and importing recipe data records

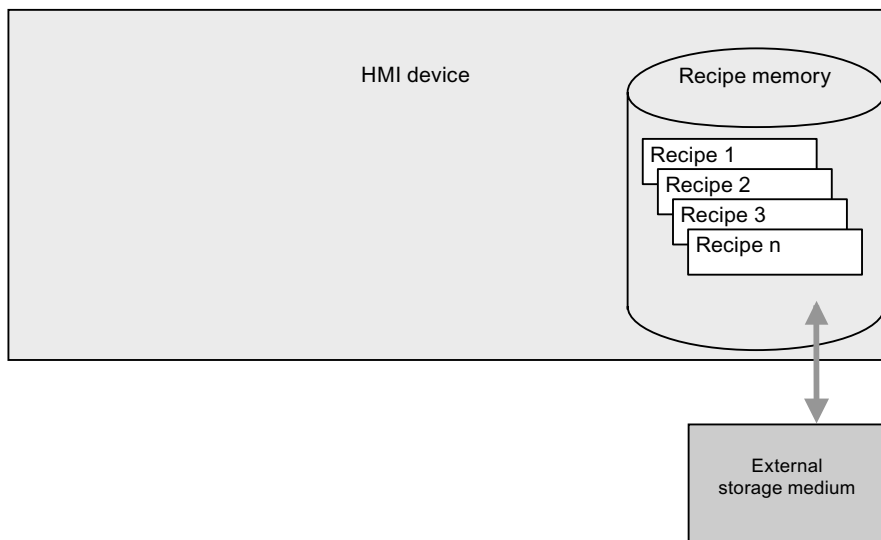

Recipe data records are exported from the HMI device recipe memory and are saved to a CSV file on the external storage medium. The records can be reimported from the storage medium to the recipe memory.

The following external storage media may be used, depending on the HMI device:

- Memory card
- USB stick
- Hard disk

8.1.6 Configuration of recipes

Introduction

Recipes are configured differently depending on the intended use.

- If you are editing recipes with a recipe view in your project, the values are only saved in recipe data records.
- If you are editing recipes in a recipe screen in your project, the values are saved in recipe tags.

The following possible settings determine how the recipe data records, recipe tags and PLC all interact.

"Synchronize tags" deactivated

The data in a data record is only displayed and can only be edited in the recipe view. Using these same tags outside of the recipe view does not affect their values.

"Synchronize tags" enabled

Differences may occur during runtime between the values displayed in the recipe view and the values saved in the associated tags when you edit recipes with a recipe view and in a recipe screen. To prevent this, the recipe data record values must be synchronized with the values of the recipe tags.

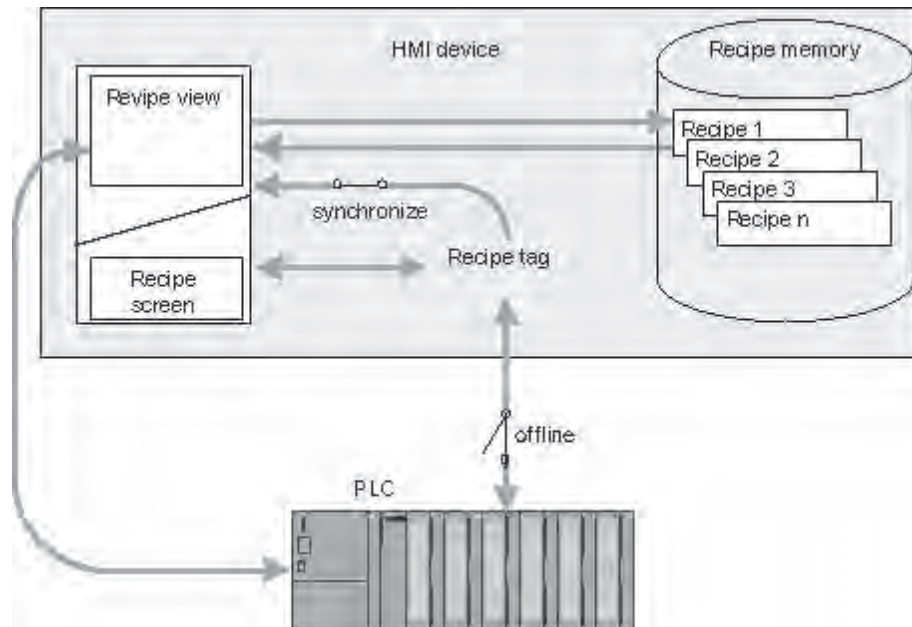
**Note**

Recipe tags can only be synchronized in the enhanced recipe view.

The values of the recipe view and the associated recipe tags are not synchronized automatically. The recipe tags and the recipe view are not synchronized until you use the operating element with the "RecipeViewSynchronizeDataRecordWithTags" function.

"Synchronize tags" and "Tags offline enabled"

With this setting, modified recipe values are not synchronized immediately between the recipe tags in the recipe screen of the HMI device and PLC.

There must be an operating element with the "SetDataRecordToPLC" and "GetDataRecordFromPLC" functions present in order to synchronize the values.

If recipe values are changed in the controller, the modified values are displayed immediately in the recipe screen if you use the operating element with the "GetDataRecordFromPLC" function.

"Synchronize tags" enabled and "Tags offline deactivated"

With this setting, modified recipe values are synchronized immediately between the recipe tags on the HMI device and PLC.

When you change recipe values in the recipe screen, these changes are applied immediately by the PLC and immediately influence the process.

If recipe values are changed in the PLC, the changed values are displayed immediately in the recipe screen.

8.1.7 Special features of the OP 77A and TP 177A

The TP 177A and OP 77A HMI devices behave differently to the other HMI devices in the following respects:

- Only the simple recipe view is supported.
- It is not possible to export or import the recipes. There is no external storage medium.

Overview of the flow of data

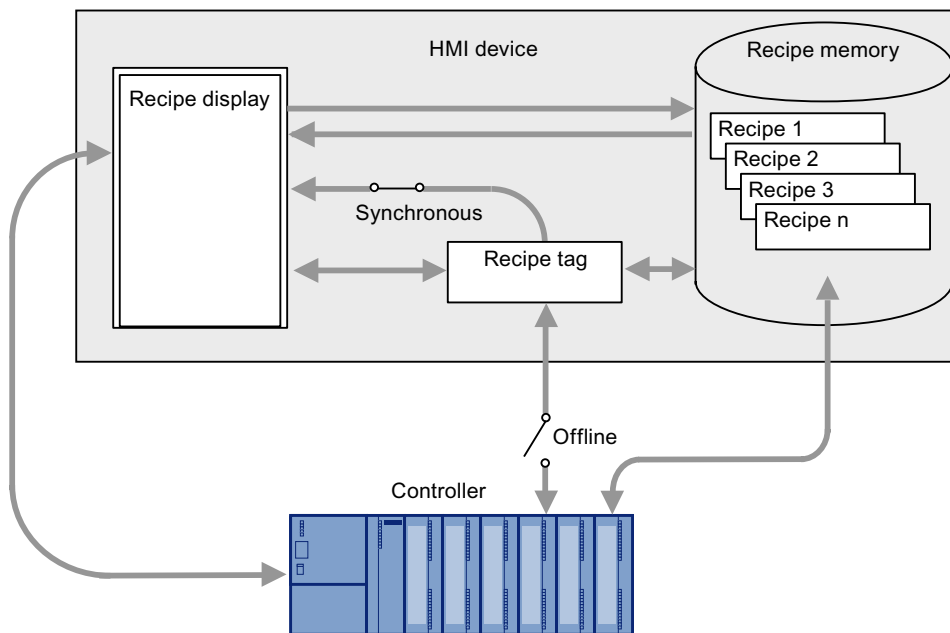

Interaction between the components

There is interaction between the following components at runtime:

- Recipe view

Recipes are displayed and edited in the recipe view on the HMI device.

The recipe data records from the internal memory of the HMI device are displayed and edited in the recipe view.

- HMI device recipe memory

Recipes are saved in the form of recipe data records in the HMI device's recipe memory.

- Recipe tags

The recipe tags contain recipe data.

Access to recipe not possible at OP 77A and TP 177A

If a recipe is modified in a project (for example if a recipe entry is deleted or added) and the project is transferred to the HMI device without recipe data, it may no longer be possible to use this recipe on the device. In as far as recipe data already exist on the device, it is no longer possible to access these.

1. Undo all changes made to the recipe in the project.
2. Transfer the project again and exclude recipe data.

You can also transfer the modified project and the recipe data to the HMI device. However, all the recipe data located on the device is irrevocably lost.

Updating the recipe view at OP 77A and TP 177A

Updating problems and displaying of values that are not up-to-date can occur in the recipe view.

Avoid reading/writing a recipe data record using jobs 69/70 while this recipe data record is being processed in the recipe view.

1. Configure a bit which you can set by pressing a button in the recipe view before you edit the data record.
2. Reset the bit by pressing the button in the recipe view after you have edited the data record.
3. Evaluate this bit in the control program

This disables the execution of control jobs 69 and 70.

Tags in recipes

Recipe tags implemented on OP 77A and TP 177A HMI devices cannot be used for any other application, for example, for the display in I/O fields or for setting dynamic I/O fields. The compiler reports any multiple instances of the tags.

Transferring recipe data records

If a project is transferred while the "Overwrite data records" option is activated, all recipe data records are deleted from the HMI device and are replaced by the transferred recipe data records.

Recipe view

- Empty field in the recipe view

An empty field is displayed in runtime if you specify a field length of 1 in a simple recipe view and the recipe element exceeds this length.

- Opening several recipe views

Several recipe views in the same screen on OP77A and TP177A will have a negative interactive effect.

For this reason, you should always open only one recipe view per screen.

8.1.8 Synchronization of recipe data records with the PLC

Overview

When recipe data records are transferred between the HMI device and PLC, both communication peers access common communications areas on the each other.

Recipe data records are always transferred directly. The values of the tags are written directly to or read directly from the configured addresses without being placed on the clipboard.

Data transfer types

There are two ways to transfer recipe data records between the HMI device and PLC:

- Transfer without synchronization
- Transfer with synchronization via the "Data record" "Area pointer"

Note

Transfer with synchronization

This is used to prevent uncontrolled overwriting of data in either direction in your control program during transfer with synchronization.

Requirements for transfer with synchronization

- The "Data record" area pointer must be set up for the required connection in the "Communication > Connections" editor.
- The PLC with which the HMI device synchronizes the transfer is specified in the recipe properties in the "Recipes" editor.

Transfer with synchronization

In the case of synchronous transfer, both the PLC and the HMI device set status bits in the shared data compartment.

Synchronous data record transfer can be a useful solution, for example, when:

- The PLC is the "active partner" for the transfer of recipe data records.
- The PLC evaluates information about the recipe number and name, as well as the recipe data record number and name.
- The transfer of recipe data records is started by the following PLC jobs:
 - "Set_data_record_in_PLC"
 - "Get_data_record_from_PLC"

8.2 Elements and basic settings

8.2.1 "Recipes" editor

Introduction

You can create, configure, and edit recipes, recipe entries and recipe data records in the "Recipes" editor. In addition, the "Recipes" editor can be used to enter values in existing recipe data records.

Open

In the "Recipes" group of the Project view, double-click on "Add recipe" or on an existing recipe.

Structure of the "Recipes" editor

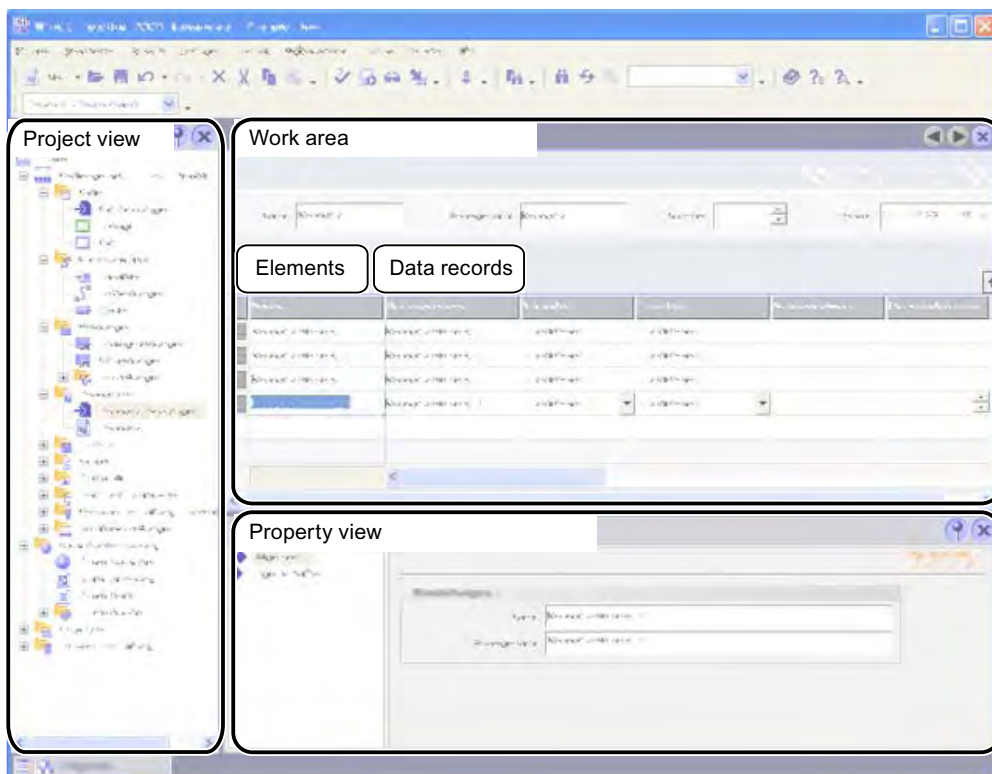

Work area

The working area is used to create and edit recipe entries and recipe data records. A recipe is defined on the "Entries" tab. Use the "Data records" tab to define the values for recipe data records.

Property view

You can configure the recipe in the Property view. For additional information on recipe settings, refer to "Recipe settings".

8.2.2 Recipe elements

Structure of the "Elements" tab



Elements in the "Elements" tab

The individual recipe entries are briefly described below.

Recipe name

The recipe name identifies the recipe uniquely within the HMI device.

Display name

The recipe's display name appears at runtime in the recipe view, for example. You can configure display names in multiple languages. You can also assign descriptive names or designations that relate directly to a product, such as "FruitJuice_Orange".

Recipe number

The recipe number identifies the recipe uniquely within the HMI device.

Version

The version identifies the date and time of the most recent change made to the recipe.

Element name

The element name identifies a recipe entry uniquely within the recipe. You can assign unique descriptive names or designations, such as axis designations on a machine, or ingredients such as "flavoring".

Assigned tag

Each Recipe entry is assigned a recipe tag in which the value of the recipe data record value is stored at runtime.

Default value

The default value is used as the default entry when you create a new recipe data record.

Text List

Text is assigned to a value or value range in a text list. This text can then be displayed in an output field, for example.

In a recipe data records, you can only use text lists that are selected by a range.

Decimal point

The number defines exactly how many decimal places will be displayed for the value of the recipe data record at runtime.

Infotext

You can enter a help message about the recipe entry in the "Help text" field. This message will then be displayed to the user at runtime.

8.2.3 Recipe data records

Structure of the "Data records" tab

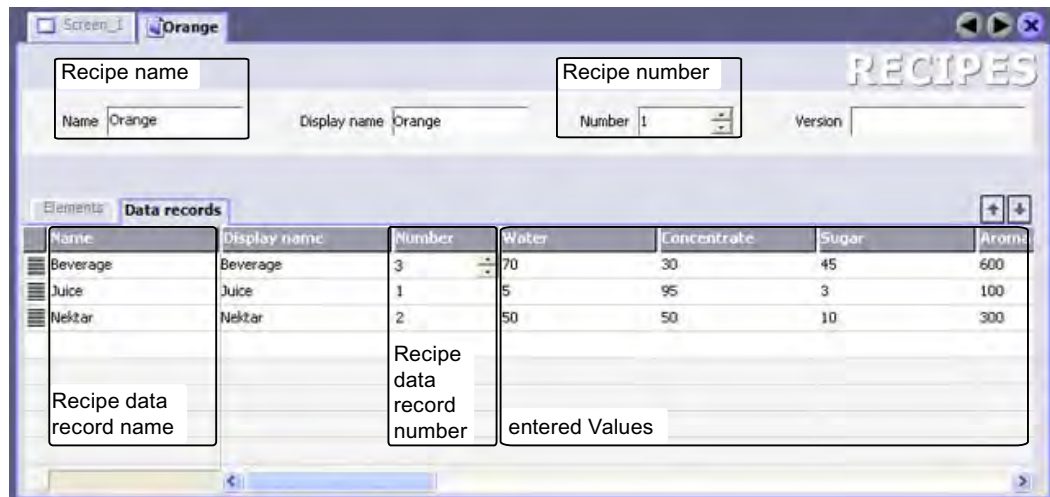

Elements in the "Data records" tab

The individual entries on the "Data records" tab are described below:

Recipe data record name

The recipe data record name identifies the recipe data record uniquely within a recipe.

Display name

The recipe data record's display name appears at runtime in the recipe view, for example. You can configure display names in multiple languages. You can also assign descriptive names or designations that relate directly to a product, such as product numbers.

Recipe data record number

The recipe data record number identifies the recipe data record uniquely within a recipe.

Entered values

You can enter values in a recipe data record during configuration. When the project is transferred to the HMI device, the recipe data records are also transferred. If the HMI device already has data records, they are overwritten after a user prompt is displayed and based on the transfer settings.

Comment

You can enter a comment about the recipe data record.

8.2.4 Recipe settings

Introduction

You enter recipe settings for a recipe in the property view.

Properties of recipe entry and recipe data record

The display in the property view is dependent on the selection you made in the "Recipes" editor: If you are editing recipe entries or recipe data records on the "Elements" or "Data records" tab, you can also modify the contents in the property view.

Example: Properties of recipe entry

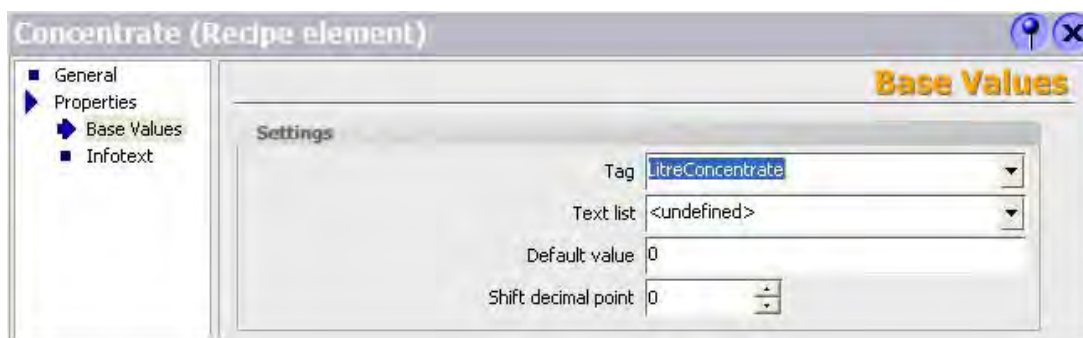

Example: Properties of recipe data record

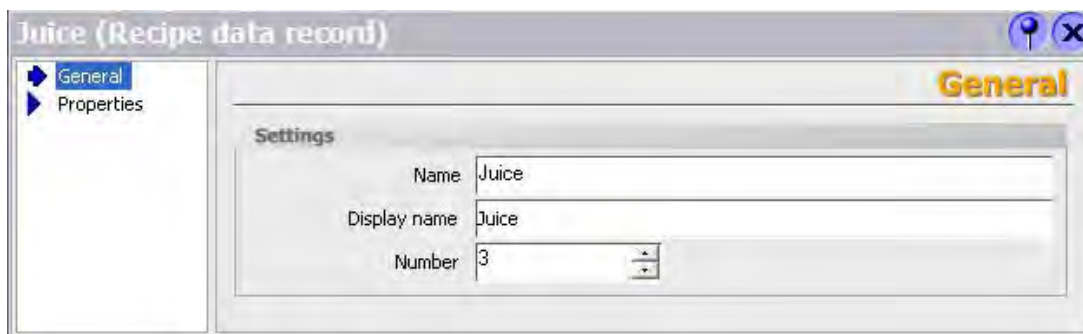

Properties of the recipe

In order to modify recipe settings, click on the "Recipe name" or "Recipe number" field in the "Recipes" editor. The following settings can be modified in the property view:

For example, you define where the file containing the recipe data records will be saved under "Data medium" in the "Properties" group. The selection capabilities are dependent on the operator panel used. Select the recipe memory or an external storage medium on the HMI device as the storage location, depending on how the HMI device is configured. When using WinCC flexible Runtime as an operator panel, save the file on the hard disk drive of the computer. Enter the path directly or navigate to the directory for the data medium using the dialog.



In the "Properties" group, configure the behavior of the recipe at runtime under "Settings". Under "Settings", define:

- Synchronization between the recipe view and recipe screen
- Transfer of the recipe tags between the PLC and HMI device.

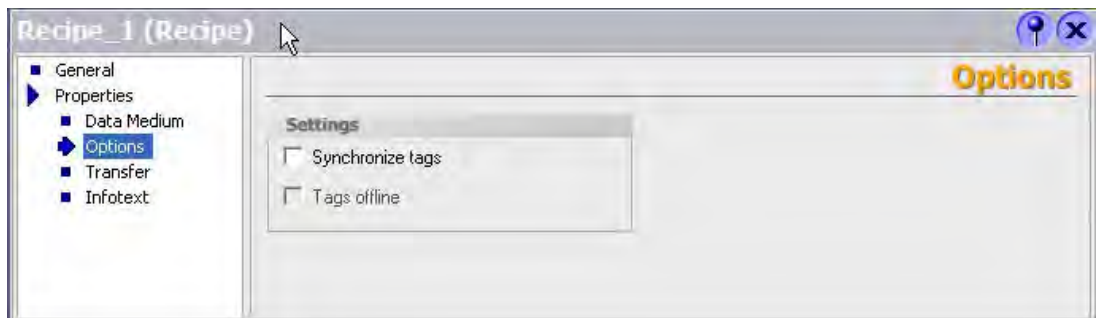

In the "Properties" group, define whether the transfer of recipe data records between the PLC and HMI device should be synchronized under "Transfer".

Note

If transfer of the recipe data record is to be synchronized, you must set up the "Data record" area pointer for the selected connection.

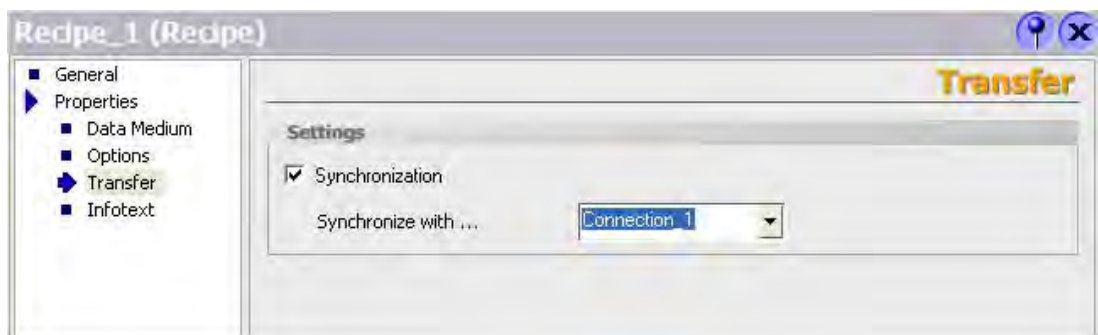

8.3 Viewing and editing recipes in Runtime

8.3.1 Recipe screen and recipe view

You can display and edit recipes on the HMI device with a recipe view or recipe screen.

Recipe view

The recipe view is an off-the-shelf screen object in WinCC flexible.

The recipe view is available in the following views:

- As enhanced recipe view
- As simple recipe view

The operating elements of the enlarged recipe view and the possible operations in the simple recipe view can both be set.

Note

It is advisable to use the simple recipe view on HMI devices with a display size of less than 6".

Recipe screen

The recipe screen is a process picture. It contains an individual input screen for the recipes. The input screen contains IO fields and other screen objects. The recipe functionality is implemented with system functions, e.g. for saving recipe data records.

Note

Recipe screen

You can configure a recipe screen in the TP 170B and higher models.

8.3.2 Recipe view

Recipe view

The recipe view is an off-the-shelf screen object used to manage recipe data records. The recipe view shows recipe data records in tabular form.

The recipe view can be represented as follows:

- As enhanced recipe view
- As simple recipe view

The operating elements of the enlarged recipe view and the possible operations in the simple recipe view can both be set.

The values displayed or entered in the recipe view are saved in recipe data records. The recipe data records are exchanged with the PLC via system functions.

Enhanced recipe view

The figure below shows an example of the enhanced recipe view.

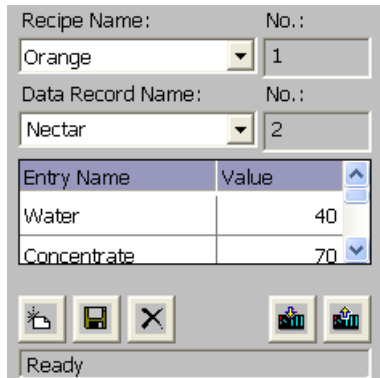

Simple recipe view

The simple recipe view consists of three areas:

- Recipe list
- Data record list
- Element list

In the simple recipe view, each area is shown separately on the HMI device. Depending on the configuration, the simple recipe view starts with the recipe list.

The figure below shows an example of the data record list.

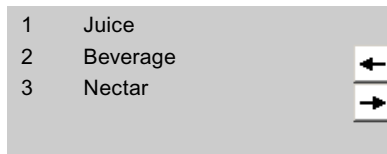

Display of values

NOTICE

Changing the recipe data record in the background

Applies to the processing of a recipe data record:

If values of the corresponding recipe data record are changed by a control job, the recipe view is not updated automatically.

To update the recipe view, reselect the respective recipe data record.

8.3.3 Configuration options for the recipe view

Introduction

Define the behavior of the recipe view and of the recipe that is displayed in the Properties window of the recipe view.

General settings

- Displaying recipe data record values only

Prevent editing of the recipe data records if you only want to view recipe data in a recipe view for inspection purposes. Disable the "Enable edit mode" option accordingly.



- Displaying a particular recipe

The view only displays the recipe data records of recipes you have defined under "Recipe name". Set the "Display selection list" option to display the recipe name in Runtime.

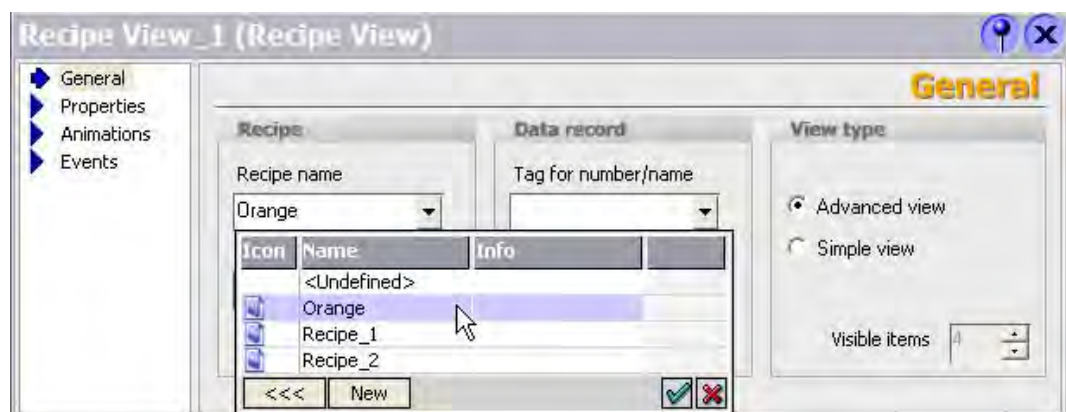

- Writing the number or name of a recipe or of a recipe data record to a tag (only for the advanced recipe view)

The number or name of a recipe or a recipe data record you have selected at "Tag for number/name" is saved to the tag. If you want to store the name, you must specify a tag of type STRING. You can, for example, transfer the tag as a parameter for a system function.

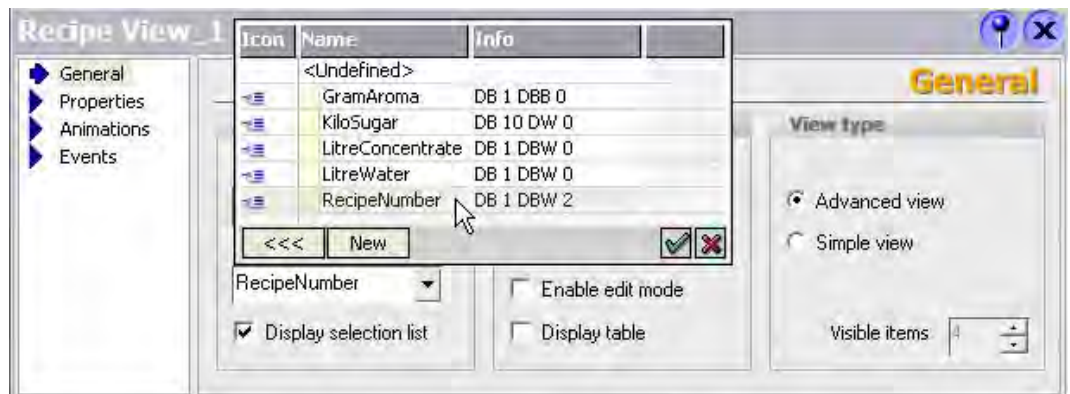

Properties

Customize the position, shape, style, color, and font types of the object in the "Properties" window. You can also define the following items:

- Menus and buttons
Select "Buttons" to specify the menu entries and buttons to be available in the recipe view. The "Synchronize tags" button is only available for the advanced recipe view.
- Caption of the recipe view
Select "Caption" to define the column headers in the advanced recipe view.

Example: Using a recipe view as selection list

Set the following parameters to use the recipe view as a selection list for recipes and recipe data records in a recipe screen:

- "Extended view": Activated
- "Tag for number/name" for recipe: Tag for the recipe name
- "Tag for number/name" for recipe data record names: Tag for the name of the recipe data record
- "Allow edit": disabled
- "Display table": disabled
- "Properties" > "Buttons": all buttons disabled

The process screen now displays only two selection lists where you can select the recipe and the recipe data record.



Animations

Assign dynamic properties to the recipe view, for example, in terms of its visibility, layout or animation. Use animations accordingly.

Note

The "Simple recipe view" object cannot be operated dynamically with a script.

In the Engineering System you can dynamically control, for example, the visibility of an object in the "Animations" group in the Properties window. An error message is output to the output window, for example, if you run a consistency check on your project data after having configured buttons and included animations.

Configuring an event on the recipe view

When you select or exit the recipe view at runtime, this is an event for which you can set up a function list to be processed.

Note

Events for the simple recipe view of all HMI devices can only be configured in the Engineering System for use in runtime if all buttons of the corresponding recipe views were disabled.

8.3.4 Behavior of the recipe view in Runtime

Screen change

If you change to another screen and have not yet saved changes to the recipe data in the recipe view, you will be prompted to save the recipe data. The recipe name and the name of the recipe data record are displayed to show which recipe data have not been saved yet.

If you change to a process screen that contains a recipe view with loaded recipe data, the recipe data will be automatically updated.

Create, change, copy or delete recipe data records

If the recipe data record already exists, a system alarm will be output to the screen.

Operating the recipe view with function keys

The Recipe view can be operated with function keys, e.g. if the HMI device does not have touch functionality. Functions such as "SaveDataRecord" can be assigned to the function keys on the HMI device.

Display after import of recipe data

If you open the recipe view during the import of recipe data, only the recipe data that is already completely imported will be displayed. The recipe view is not automatically updated with a data import. In order to have a complete view of all the recipe data, do not open the recipe view until the system prompts you that the recipe data has been imported successfully. Alternatively, update the recipe view after successful completion of the import procedure.

Updating tag for recipes and recipe data records

The current recipe data record or its number can be saved to a tag, depending on the configuration. The tag will be updated under the following conditions.

- The recipe data record has been loaded.
- The screen with the recipe view was not exited during the process.

This operation may take some time.

8.3.5 Recipe screen

Introduction

The recipe screen is a process picture. It contains an individual input screen for the recipes. The input screen contains IO fields and other screen objects. The recipe functionality is implemented with system functions, e.g. for saving recipe data records.

The figure below shows an example of the recipe screen.

The screenshot shows a recipe configuration interface. On the left, there is a table of ingredients with their respective quantities and units:

Water	40	l
Concentrate	70	l
Sugar	30	kg
Aroma	30	l

On the right, there are two dropdown menus for selecting recipe and data record names, each with a corresponding number:

Recipe name	No.:
Orange	1
Data record name	No.:
Nectar	2

At the bottom, there are four buttons: "Save", "Data from the PLC", "Load", and "Data to PLC".

Note

You can configure a recipe screen in the TP 170B and higher models.

Principle

Configuration of a recipe screen offers you the opportunity for customization: You can spread large recipes over several process screens according to topic and display them vividly, using features such as graphical screen objects.

- Spreading recipes over several process screens according to topic
 - You can distribute recipe data records with multiple entries across several process images. E.g. for each plant section you can configure a process image containing the associated input screens for the recipe data records.

Splitting recipes among several process screens is useful for HMI devices with small displays. For one thing, you can avoid having to scroll in tables during runtime.

- Visual machine simulation

You can visually simulate your machine in a process screen using graphical screen objects. This enables you to display parameter settings more clearly by positioning IO fields directly beside machine elements such as axes or guide rails. You can use this to produce a direct reference between the values and the machine.

Synchronize tags

You must enable the "Synchronize tags" function in the recipe properties in order to be able to enter recipe data record values in the configured IO fields outside the recipe view. The figure below shows the settings in WinCC flexible:

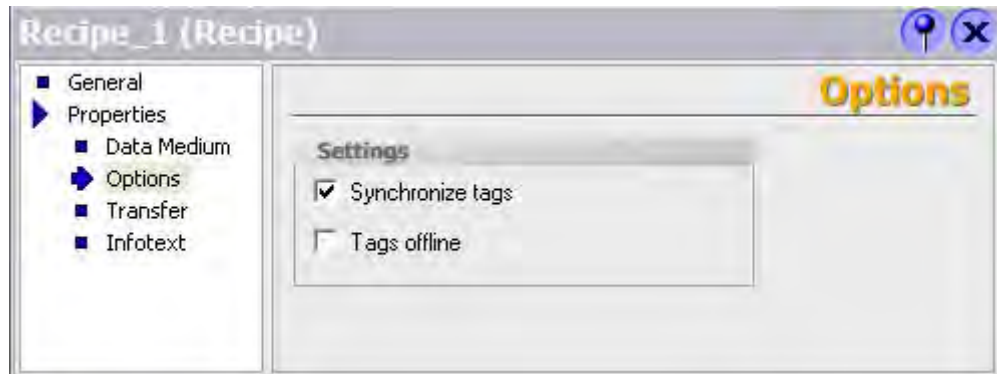

You must synchronize the tags in order to synchronize data between the tags of the recipe screen and the recipe data records displayed in the recipe view. Synchronization of tags is only possible in the enhanced recipe view.

Tags offline

If the entered values are to be transferred immediately to the connected PLC during runtime, you must disable "Tags offline" in the Properties window.

Configure the "SetRecipeTags" system function if you want to enable and disable immediate transfer of entered values during runtime.

System functions

The following system functions are available for operator control of a recipe screen:

- ImportDataRecords
- ExportDataRecords
- LoadDataRecord
- SaveDataRecord
- SetDataRecordTagsToPLC
- GetDataRecordTagsFromPLC

The following system functions are available for operator control of the recipe view when it is being used in the recipe screen:

- RecipeViewSaveDataRecord
- RecipeViewSaveAsDataRecord
- RecipeViewSynchronizeDataRecordWithTags
- RecipeViewDeleteDataRecord
- RecipeViewNewDataRecord
- RecipeViewGetDataRecordFromPLC
- RecipeViewRenameDataRecord (for simple recipe view only)
- RecipeViewShowOperatorNotes
- RecipeViewMenu (for simple recipe view only)
- RecipeViewOpen (for simple recipe view only)
- RecipeViewBack (for simple recipe view only)

The system functions for loading, saving, and transferring recipe data records and recipes are located in the "Recipes" group.

8.3.6 Operator input of the recipe view

Application

The recipe view is used to display, edit and manage data records.

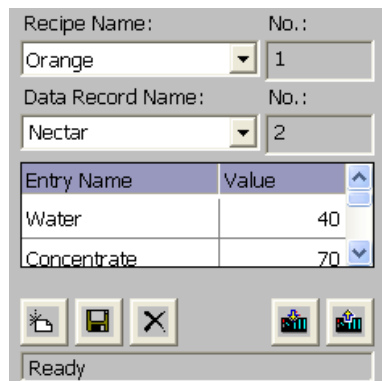









Operation

Depending on the configuration you can:

- Create, change, copy or delete recipe data records
- Synchronize recipe data records with the associated recipe tags
- Read recipe data records from or transfer to the PLC

Operating elements

The following operating elements can be configured in the recipe view:

Button	Hotkeys	Function
		The configured help text is displayed.
	<Ctrl+Space Bar>	Creates a new recipe data record. If a start value is configured, it is shown in the input field.
	<Ctrl+Enter>	Saves the displayed values of the recipe data record. The storage location is predefined by the project.
	<Ctrl+*>	The recipe data record is saved under a different name regardless of the recipe view. A dialog box opens in which the name is entered.
	<Ctrl+Del>	The displayed recipe data record is deleted.
	<Ctrl+=>	The system always updates the current value of the recipe view with the up-to-date recipe tag value. When the value shown in the recipe view is more recent than the current recipe tag value, the system writes this value to the recipe tag. "Synchronize tags" must be enabled in the recipe properties before this function can be used.
	<Ctrl+Down>	The values of the set recipe data record displayed in the recipe view are transferred to the PLC.
	<Ctrl+Up>	The recipe values from the PLC are displayed in the recipe view.

Mouse control or touchscreen control of the recipe view

1. Select the recipe you want to use.
The records for the recipe are displayed.
2. Click on the data record you wish to edit.
3. Press the button whose function you wish to execute.

Using the keyboard with the recipe view

1. Press the <Tab> key until the recipe is selected in the recipe view.
2. Press <Enter>.
The drop-down list box for the recipes opens.
3. Choose a recipe or a record from the list. Toggle between the next or previous entry by using the cursor keys <Left>, <Right>, <Up> and <Down>.
4. Press the <Tab> key until the operating element you wish to use is selected.
Alternatively, you can operate the recipe view via key combinations.

8.3.7 Operator input of the simple recipe view

Display mode

The simple recipe view consists of three areas:

- Recipe list
- Data record list
- Element list

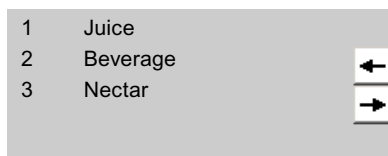

Simple recipe view - example with data record list

In the simple recipe view, each area is shown separately on the HMI device. You can use the shortcut menu to operate each of these display areas.

The simple recipe view always begins with the recipe list.

Operation

You can use the simple recipe view as follows, depending on the configuration:

- Create, change, copy or delete recipe data records
- Read recipe data records from the PLC or transfer to the PLC

Using the simple recipe view

Toggle between the display areas and the shortcut menus to operate the simple recipe views.

The table below shows the operation of the display area.

Button	Key	Function
	<Enter>	The next lowest display area is opened, i.e. the data record list or the element list.
	<Esc>	The previous display area opens.
	<Right>	The shortcut menu of the display area opens.
	<Up>/<Down>	Selects the previous/next entry.
	<Pg Up>/<Pg Down>	Moves the display up or down one page.
	<Home>/<End>	Selects the first/last entry. The first/last entry is selected.

The table below shows the operation of the shortcut menu:

Button	Key	Function
	<Esc>	The menu is closed. The display area opens.
	Input of the number of the menu command	The menu command is executed.

Shortcut menus of the simple recipe view

A command option selection can be called in for each display area by pressing the  button. The command selection lists those commands that are available in the current display area. A number is assigned to each command. The command is executed when you enter this number.

- Recipe list

Menu command	Function
New	A new recipe data record is created for the selected recipe. If a start value is configured, it is shown in the input field.
Viewing info text	The info text configured for the simple recipe view is displayed.
Open	The record list of the selected recipe opens.

- Data record list

Menu command	Function
New	Creates a new recipe data record. If a start value is configured, it is shown in the input field.
Delete	The displayed record is deleted.
Save as	The selected data record is saved under a different name. A dialog box opens in which the name is entered.
Rename	The selected record is renamed. A dialog box opens where you can enter the name.
Open	The element list of the selected data record opens.
Previous	The recipe list opens.

- Element list

Menu command	Function
Save	The selected record is renamed.
To PLC	The display values of the selected record are transferred from the HMI device to the PLC.
From PLC	The recipe values from the PLC are displayed on the HMI device in the recipe view.
Save as	The data record is saved under a new name. A dialog box opens where you can enter the name.
	Press the <ESC> key to open the data record list.

The following menu commands can also be configured on the TP 177A and OP 77A HMI devices:



- Data record list

Menu command	Function
To PLC	The displayed values of the selected data record are transferred from the HMI device to the PLC.
From PLC	The recipe values from the PLC are displayed in the recipe view of the HMI device.
Display help ...	Displays the help text configured for the simple recipe view.

- Element list

Menu command	Function
Display help ...	Displays the help text configured for the simple recipe view.
Rename	Renames the selected data record. A dialog box opens where you can enter the name.
Previous	Opens the data record list.

Mouse control or touchscreen control of the simple recipe view

1. Select the desired recipe from the recipe view.
2. Click on the  button.
 The shortcut menu is opened.
3. Select the desired menu command.
 The menu command is executed.
4. Alternatively, open the desired recipe in the recipe view.
 The data record list is displayed.
5. Open the desired data record. Alternatively use the  button to open the shortcut menu and select a menu command.
 The menu command is executed.

Using the keyboard with the simple recipe view

1. Press the <Tab> key until the simple recipe view is selected.
2. Select the desired recipe with the cursor keys.
3. Press <Right>.
 The shortcut menu is opened.
4. Press the <Down> key until the desired menu command is selected.
5. Press <Enter> to confirm the command.
6. Alternatively, press the number of the desired menu command.
 The menu command is executed.

8.3.8 Reactions to modifications of the recipe structure

Introduction

Different recipe structures can occur in the following situations:

- In the event of changes during commissioning
- When work is carried out on the machine by the machine manufacturer (retrofit)
- When CSV files are imported, the structure of the CSV file can differ from the recipe structure.

Nevertheless, you can still use any recipe data records already created.

CAUTION

When a tag is renamed, the assignment is lost.
--

Effects

Structural differences are handled as follows:

- If the old recipe data record or the CSV file contains any additional values, these values will be discarded.
- If the old recipe data record or the CSV file contains values of the wrong data type, the configured default value is used in the recipe data record.

Example: The recipe data record contains values that show the tank contents and were input as floating point numbers. However, the corresponding recipe tag expects an integer value. In this case, the system discards the transferred value and the configured default value is used.

- If the old recipe data record or the CSV file contains too few values, the configured default value is again used in the recipe data record.

8.4 Scenarios

8.4.1 Scenario: Entering recipe data records in Runtime

Objective

You want to enter production data on the HMI device without disturbing the process that is currently underway. Therefore, the production data should not be transferred to the PLC.

Requirements

- The recipe has been created. The recipe has the following settings:
 - "Synchronize tags" is checked or unchecked.
 - If "Synchronize tags" is checked, then "Tags offline" must also be checked.

This will prevent the recipe tags being transferred automatically between the HMI device and PLC.
- A recipe screen or mimic with recipe view is available.
- There is an operating element for saving the recipe data records.

Sequence

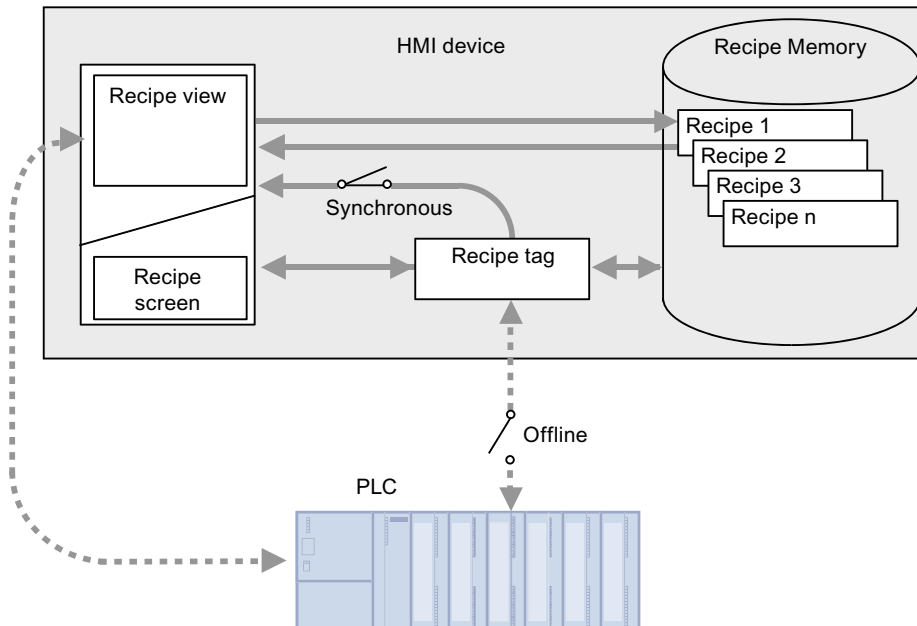

1. Enter the production data in the recipe view or recipe screen.
2. Save the modified recipe data record.
3. Alternatively save the recipe data record with a new name.

The recipe data record is saved in the recipe memory of the HMI device.

Transfer the recipe data to the PLC

The configuration may provide operating elements for transferring recipe data to the PLC.

8.4.2 Scenario: Manual production sequence

Objective

A reading device connected to the PLC reads a bar code on the work piece to be processed. The recipe data record names correspond to the respective bar code names. This will enable the PLC to load the necessary recipe data record from the storage medium of the HMI device. The recipe data record is displayed for inspection on screen.

You want to be able to correct the transferred production data online, if necessary.

Requirements

- The recipe has been created. The recipe has the following settings:
 - "Synchronize tags" has been enabled.
 - "Tags offline" has been deactivated.

Note

The changes are transferred immediately to the PLC

- There is a recipe screen available. There may also be an operating element for saving the recipe data records in the recipe screen.

Sequence

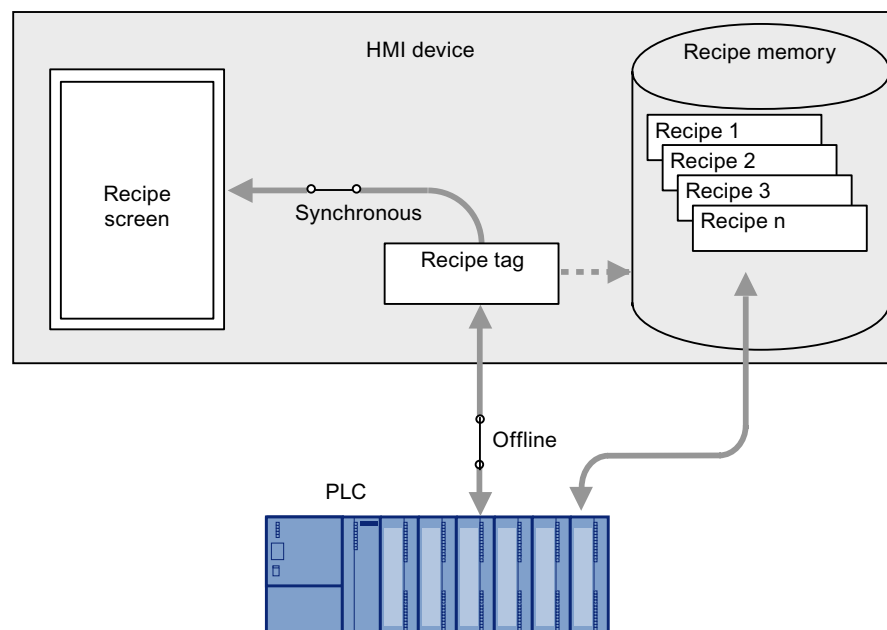

Behavior when the recipe view is used

If the recipe view is used, it is not possible to transfer changes immediately. You must use the operating element to transfer the recipe data record to the PLC.

8.4.3 Scenario: Automatic production sequence

Objective

You want production to be executed automatically. The production data is to be transferred directly to the PLC, either from the recipe memory in the HMI device or from an external storage medium. The screen display is not necessary.

Requirements

- The recipe has been created. The recipe has the following settings:
 - "Synchronization" is enabled under "Transfer".

The production data is transferred to the PLC, so it is necessary to synchronize with the PLC to prevent the data from being accidentally overwritten.

Sequence

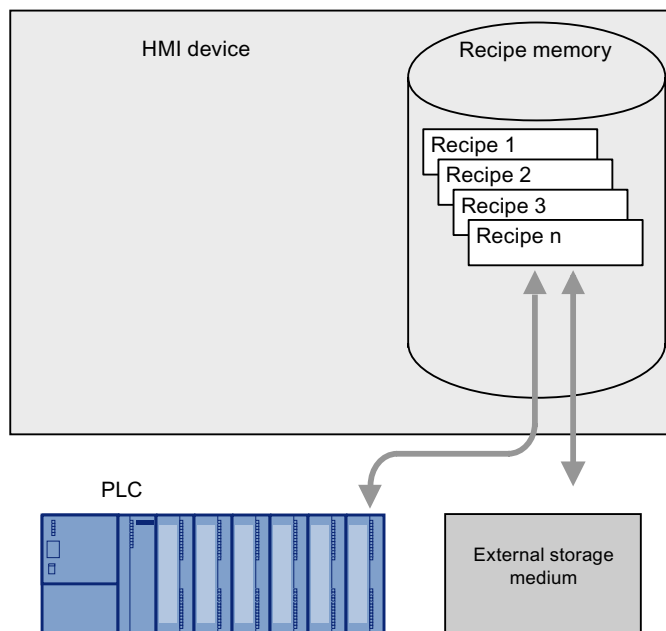

Implementation

You can control the flow of data in the following ways:

- The control program controls the automatic transfer via control jobs or, if necessary, via WinCC flexible system functions.
The sequence is controlled via the status information in the mailbox and via return values from the functions used.
- One or more scripts control the automatic transfer via WinCC flexible system functions.
The sequence can be checked using the values returned by the functions used.

You can implement the automatic production sequence with available system functions:

- "ImportDataRecords"
This function loads data records from a *.CSV file onto the recipe memory on the HMI device.
- "SetDataRecordToPLC"
This function transfers a data record from the HMI device's recipe memory to the PLC.

Logging and displaying tags

9.1 Basics

9.1.1 Basic principles for data logging

Introduction

Data logging is used to capture, process and log process data from industrial equipment. The collected process data can then be analyzed to extract important business and technical information regarding the operational state of the equipment.

Application of the data logging

You can use data logging to analyze faults and to document the process run. By analyzing data logs, you can extract the information necessary to allow you to optimize maintenance cycles, increase product quality and ensure that quality standards are met.

9.1.2 Data logging in WinCC flexible

Introduction

Data is information that is collected during the process and saved in the memory of one of the connected automation systems. This data reflects the state of the equipment, e.g. temperatures, fill levels or states (e.g. motor off). To work with the process variables, you must define tags in WinCC flexible.

In WinCC flexible, external tags are used to collect process values and to access a memory location in a connected automation system. Internal tags are not connected to any process and are only available to their respective HMI device.

Principle

The values from external and internal tags can be saved in data logs. You can individually specify the log in which each tag will be saved.

Data logging is controlled via cycles and events. Logging cycles are used to ensure continuous acquisition and storage of the tag values. In addition, data logging can also be triggered by events, e.g. when a value changes. These settings can be made for each tag individually.

In runtime, the tag values which are to be logged are captured, processed and stored in an ODBC database or a file.

Log types

In WinCC flexible, you can select from the following log types:

- Circular log
- Segmented circular log
- Circular log which sends a system alarm message when it is full
- Circular log which executes system functions when it is full.

Storage media and storage location

The logged data will be stored in either an ODBC database (only on a PC) or a file.

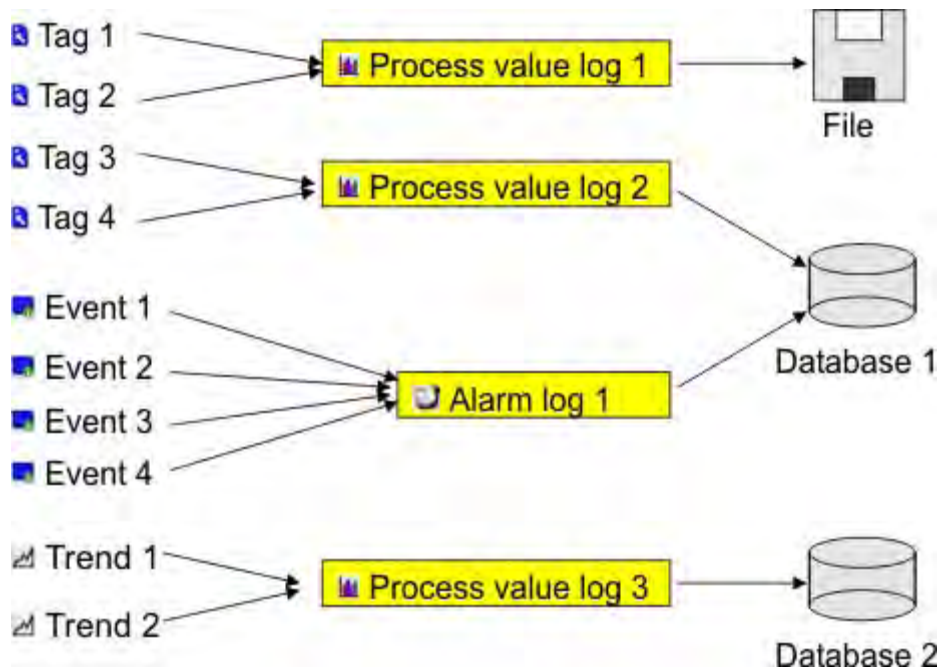

Depending on the hardware configuration of the HMI device, the data may be logged locally (on the hard disk of a PC or on the storage card of a panel) or, if present, on a network drive.

Select one of the following storage locations:

- Database
All data is saved to an ODBC database.
- File - CSV (ASCII)
Data is saved to a CSV file in standard ASCII format.
- File - RDB
Data is saved to a relational database for quick access.

Saved data can undergo additional processing in other programs, e.g. for analysis purposes.

Outputting the contents of a log

In runtime, you can output the logged tag values as trends in the process screens.

9.1.3 Trends

Introduction

A trend is a graphic representation of the values that a tag takes during runtime. In order to display trends, configure a trend view in a screen of your project.

To configure the trend view, specify a trend type for the values to be displayed.

- Log: For displaying the logged values of a tag
- Realtime pulse triggered: For time-triggered display of values
- Realtime bit triggered: For event-triggered display of values
- History bit-triggered: For event-triggered display with buffered data acquisition

Displaying logged values

The trend view shows the logged values within a definable time period. In runtime, the operator can shift the time period to view the desired information (logged data).

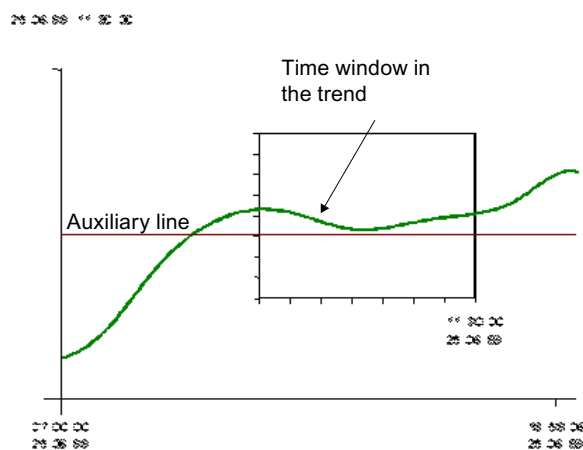

Pulse-triggered trends

The values to be displayed are determined individually with a definable time pattern. Pulse-triggered trends are suitable for representing continuous courses such as the changes in the operating temperature of a motor.

Bit-triggered trends

The values to be displayed are event-driven by setting a defined bit in "Trend transfer" tags. The bit is reset after reading has been completed. Bit-triggered trends are useful for displaying fast changing values such as the injection pressure for producing plastic parts.

Bit-triggered trends with buffered data acquisition

When you set buffered data acquisition, the values to be displayed are buffered in the PLC and read in bit-triggered as a block. These trends are suitable for displaying rapid changes when the course of the trend as a whole is interesting and not so much the individual values.

You configure a switch buffer in the PLC so it can continue to write the new values while the trend buffer is being read. The switch buffer ensures that the PLC does not overwrite values while the operator device reads the values for the trend.

The switch between the trend buffer and the switch buffer functions as follows:

Whenever the bit which is assigned to the trend is set in the "Trend transfer 1" tag, all the values are read simultaneously from the trend buffer and displayed as a trend at the operator device. The bit in "Trend Transfer 1" is reset after reading has been completed.

While the operator device is reading the tag values from the trend buffer, the PLC writes the new tag values into the switch buffer. When the bit which is assigned to the trend is set in the "Trend transfer 2" tag, all the trend values are read from the switch buffer and displayed at the operator device. While the operating device is reading the switch buffer, the PLC writes again to the trend buffer.

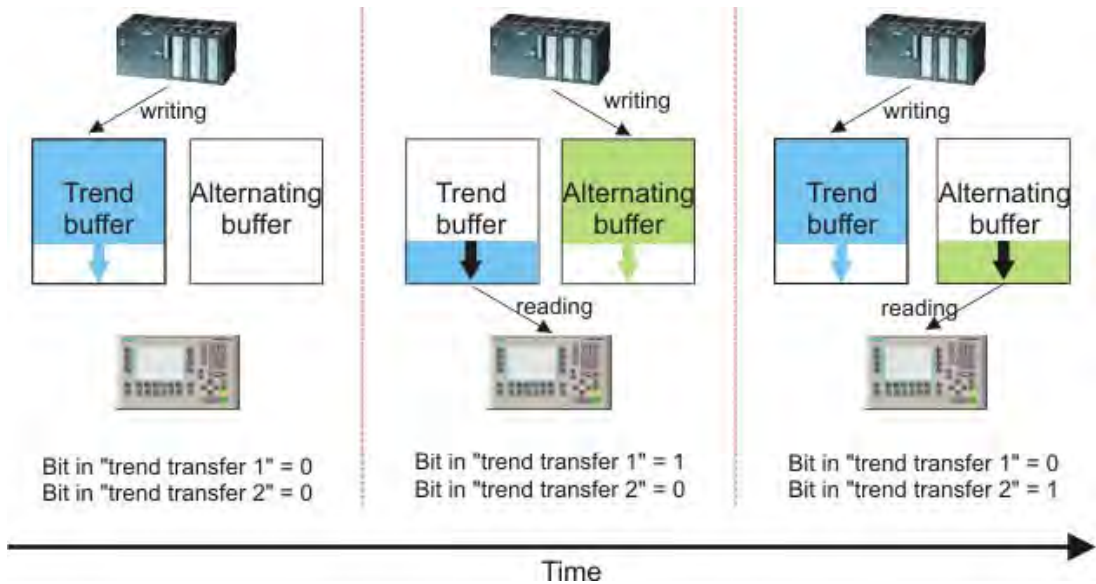

9.2 Elements and basic settings

9.2.1 "Data Logs" editor

Introduction

To log process values, they must be assigned to a log. You can plan logs and specify their properties in the tabular "Data Log" editor.

Open

In the project window in the "Log" group, double-click on "Data logs" to open the "Data log" editor.

Structure

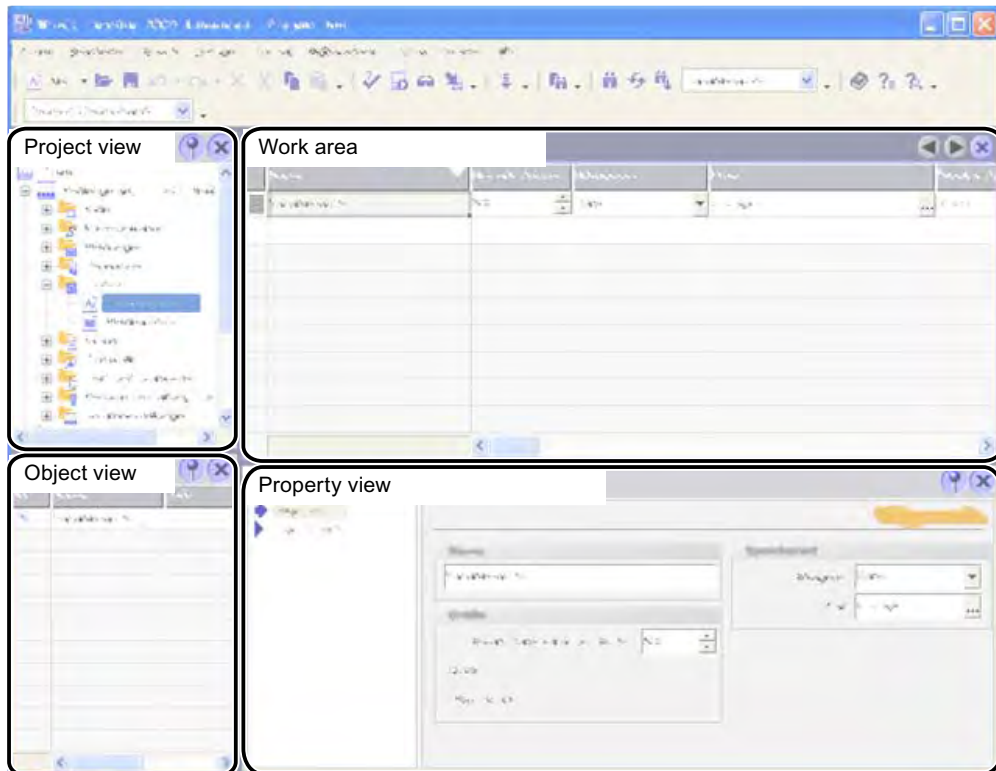

Data logs editor

Work area

All the data logs are displayed in a table in the work area. You can edit the properties of the data logs in the table cells. You can sort the table according to the entries in a column by clicking on the column header.

You can show and hide the table columns. To do so, activate or deactivate the entries in the pop-up menu of the column table header.

Property view

Here you configure data logs. The property view offers the same information and settings as the work area table.

9.2.2 Basic settings for data logs

Introduction

The properties of a data log can be defined in the "Data log" editor or in the Properties window for logs.

Structure of the Properties window

The Properties window has a tree structure on the left from which you can select all property categories. The fields for configuring the currently selected properties category are shown on the right of the Properties window.

You can set the following properties for data logs in the Properties window:

General properties

- Name

The data log may be given any desired name, but the name must include at least one letter or number.

- Storage location

The tag log is saved to an ODBC database (only on a PC) or to a separate file. Select a "Database" or a file as corresponding storage location.

Depending on the configuration of the HMI device, you can select the local hard disk of the PC or the storage card of the panel or, if present, a network drive as "path."

If you choose an ODBC database as a storage location, you have the following possibilities for the names of the data source:

- "System-defined data source name", if you want the name to be assigned by the system.

Note

Windows VISTA does not support databases with "System-defined data source" option.

You can only use databases with "User-defined data source" option. As administrator, you must have created and enabled these databases on the PC.

Refer to the documentation of your database software for details.

You will also need on the target system a special instance of the Microsoft SQL server. You may want to download the free SQL Server 2005 Express for this purpose.

This setting is not available on the Panel PC 477.

- "User-defined data source name," if you want to assign the name of the data source yourself.

- Size

The size of a log is calculated as follows:

The number of items * the length of each tag value to be logged.

In the Properties window, the minimum and maximum sizes of the log using the currently selected "Number of data records" are shown under the "Number of data records" input field. The maximum size of a log is limited by the amount of storage on the HMI device.

Settings for the log behavior

- Start-up behavior

Under Enable you can specify that logging starts when runtime is started. Enable the checkbox "Enable logging at runtime start."

You can also control the behavior at runtime start in other ways. Enable "Reset log" if you want to overwrite previously logged data with the new data or "Append data to existing log" if you want to append new data to an existing log.

Note

You can use system functions to control the Restart of a log during runtime.

- Logging method

Here you can specify what should happen when the log is full. You can choose one of the following options:

- Circular log: When the log is full, the oldest entry will be overwritten.
- Segmented circular log: Multiple logs of the same size will be created and filled one after the other. When all logs are completely full, the oldest log is overwritten.
- Display system message when: When a defined fill level is reached a system message is displayed.
- Trigger event: The "Overflow" event is triggered as soon as the log is full.

- "Comment"

Here you can enter descriptive text regarding the log.

Events

Here you can configure a function list which will be processed whenever an "Overflow" event is triggered by the overflow of the log.

9.3 Logging tag values

Introduction

In runtime, tag values can be stored in logs for later evaluation. For the logging of a tag, you must specify the log in which the values are to be stored, how often this should happen and whether only the tag values in a specific value range are to be saved.

Note

The main purpose of data logging is to log the values of external tags. However, you can also log the values of internal tags.

Principle

Several steps are involved in data logging:

- Creating and configuring data logs

When creating a data log, you must define the following:

- General settings, e.g. name, size, storage location
- Behavior at runtime start
- Behavior when the log is full

- Configuring the logging of tags

You can specify a data log for every tag. This log records the values of the tags in runtime and other information, e.g. the time the value was logged.

Furthermore, you can define when and how often the value of the tag should be logged.

To perform the latter, you have the following options:

- "On request":

The tag values are logged by calling the "LogTag" system function.

- "On change":

The tag values are logged, as soon as the operator device detects a change of value in the tag.

- "Cyclic continuous":

The tag values are logged at regular intervals. In addition to the standard cycles available in WinCC flexible, you can add cycles of your own, which are based on the standard cycles.

Furthermore, you can restrict the logging to those values that are within or outside of a tolerance band. In this manner, you can distribute tag values specifically to different logs for separate analysis later.

If you log a tag "upon request", this tag should not be logged in a sequence log in which the tags "cyclically continued" or "if changed" are logged. If the logging upon request occurs only rarely, then the sequence log is, for example, completed with cyclically logged values and the next sequence log is set up. If there is then an access to the tag that has been logged upon request, the tag cannot be shown as in runtime the current sequence log is being accessed. As a remedy, for rarely logged tags, set up a separate tag log.

- Processing logged tag values further

The logged process tag values can be evaluated directly in your WinCC flexible project, e.g. in a trend view, or with another application, e.g. Excel.

9.4 Outputting logged data

9.4.1 Outputting tag values in screens

Introduction

In runtime you can output tag values in the screens of the operator device in the form of a trend. The data can be requested by the PLC from the current process or be loaded from a log database.

Displayed values

You have to configure a trend view in a screen so that tag values are displayed at the operator device. When configuring the trend view you specify which tag values are displayed:

- Current values from the PLC

The trend can be continued either with individual values from the PLC (display in real-time) or with all the values which are stored in a buffer between two read processes from the PLC (display of an interval).

The reading moment can be controlled by setting a bit or by means of a cycle.

- Logged tag values

In runtime the trend view displays the values of a tag from a data log. The trend shows the logged values in a particular window in time. In runtime, the operator can shift the window in time to view the desired information (logged data).

9.4.2 The structure of a *.csv file with tag values

Introduction

In the *.csv (Comma separated value) file format, table columns (name and value of entry) are separated by a semicolon. Each table row ends with a carriage return.

Example of a *.csv file

The example shows a file with logged tag values:

```
"VarName";"TimeString";"VarValue";"Validity";"Time_ms"
"Var_107";"01.04.98 11:02:52";66,00;1;35886460322,81
"Var_107";"01.04.98 11:02:55 AM";60.00;1;35886460358.73
"Var_107";"01.04.98 11:02:57 AM";59.00;1;35886460381.22
```

Structure of a log file in *.csv format

The following values are entered in the individual columns of a WinCC flexible log file:

Parameter	Description
VarName	Name of the WinCC flexible tag
Time string	Time stamp as a STRING, e.g. readable date format
VarValue	Value of the tag
Validity	Validity: 1 = value is valid 0 = an error occurred (e.g. interrupted process connection)
Time_ms	Specify a time stamp as a decimal value (see below for conversion). Only needed to display the tag values in a trend.

Conversion of the time stamp decimal value

If the value needs to be processed using a different program, proceed as follows:

1. Divide Time_ms by 1,000,000.

Example: : 36343476928:1 000 000 = 36343,476928

2. The whole number portion (36344) is the date calculated from 31.12.1899.

Example: 36343 results in 02.07.1999

You can now convert the time stamp value to days in Excel by assigning a corresponding format from the "Date" group to the cells, which contain the time stamp.

Result: 37986 results in 31.12.2003

3. The value after the comma (0,476928) indicates the time:

- Multiply the value (0,476928) by 24 results in the hours (11,446272).
- Multiply the remainder (0,446272) by 60 results in the minutes (26,77632).
- Multiply the remainder (0,77632) by 60 results in the seconds (46,5792).

Sum 11:26:46.579

This conversion is supported by Microsoft Excel, for example.

9.4.3 Accessing the ODBC log database directly

Introduction

The storage location of a log can be a database or a file.

The database is addressed by means of its "Data source name" (DSN). Select the database you would like to use in WinCC flexible in the Windows Start menu under Settings > Control panel > ODBC data sources.

To store log data, specify the "Data source name" (DSN) instead of a directory name when making your configuration settings. With the DSN, you are referencing the database and the storage location.

Application

The entire functional scope of the database is available for additional processing and evaluation of log data.

Principle

You create the data source that connects to the database on the same computer that contains the runtime software. You then specify the DSN configured here when you create a log in WinCC flexible.

Using the ODBC interface, you can access the database directly with other programs, such as the MS SQL server.

With the "StartProgram" system function, you can also configure a program call on the HMI device. This does not interrupt the runtime program sequence.

Working with reports

10.1 Principles on the report system

Introduction

In WinCC flexible, reports are used to document process data and completed production cycles. You can report messages and recipe data in order to create shift reports, output batch data, or to document a manufacturing process for the acceptance test.

Overview

You can edit the report files in the graphic editor. In this editor, you configure the layout of the reports and determine the output data. You can add various objects for the output of data to a report file. Some of the toolbox objects are either available with restricted functionality or not at all. This depends on the HMI device you are configuring. Objects not available in the toolbox are grayed out and cannot be selected.

You can create separate report files for reporting different types of data. You can set the triggering of the output separately for each report file. You can choose to trigger the output of data at a specific time or in defined intervals, or by other events.

The modular structure of these features allows you to explicitly configure reports for different requirements.

Application Examples

At the end of a shift, create a shift report which contains the batch data and error events of the completed production.

You can create a report which outputs the recorded production data of a batch production.

You can create a report which outputs messages of a certain class or type.

10.2 Structure of reports

Structure of a report

The reports in WinCC flexible all have the same basic structure. They are subdivided into different sections as shown in the figure below.

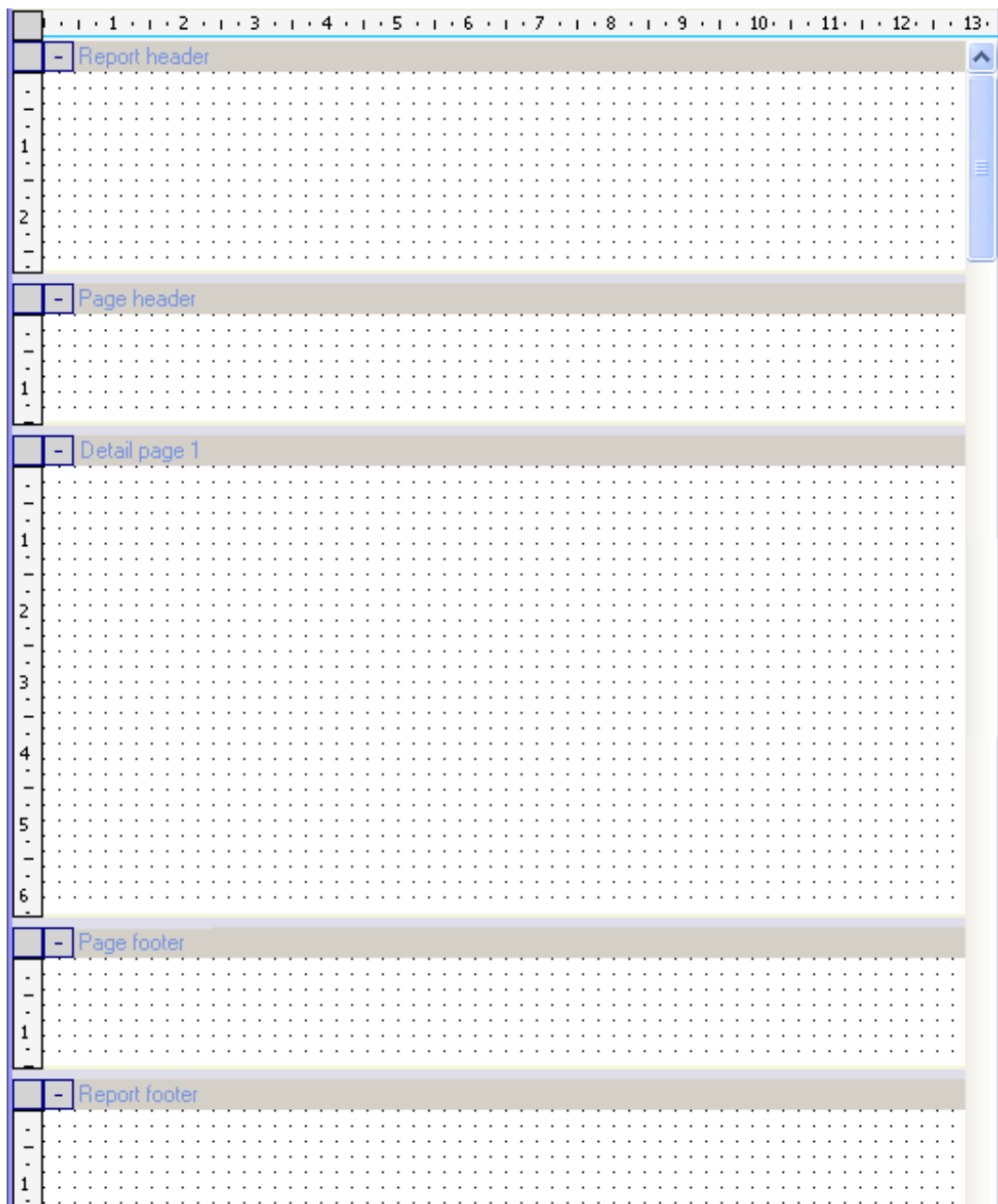

Protocol

The individual sections are used to output different data and can contain general objects and specific report objects.

- **Report header**

The report header serves as the cover sheet for a report. The report header is used to output the project title and general information on the project. The report header is output without page header and without page footer. The report header is output once at the start of a report.
- **Report footer**

The report footer is used as the final page of a report. The report footer is used to output a summary of the report or other information which is required at the report end. The report footer is output without page header and without page footer. The report footer is output once at the end of a report.
- **Page header**

The page header is output with every page of a report. The page header is used to output the date, time, title or other general information.
- **Page footer**

The page footer is output with every page of a report. The page footer is used to output the page numbers, the total number of pages or other general information.
- **Detail page**

The runtime data are output in the "Detail page" area. The objects for outputting the runtime data are inserted in the "Detail page" area. When you output the data, page breaks are added automatically depending on the amount of data. You can also insert several pages into a report in order to optically separate the configuration of various output objects.

The creation of a report is described in the "Creating a report" chapter.

10.3 Elements and basic settings

10.3.1 Editor "reports"

Introduction

You can create and edit reports with the report editor.

Open

Select the "Reports" entry in the project view and open the pop-up menu. Select the "New report" command in the pop-up menu. A new report is created and opened in the work area.

In order to open an existing report, double-click in the object view on the desired report. The selected report is opened.

Layout

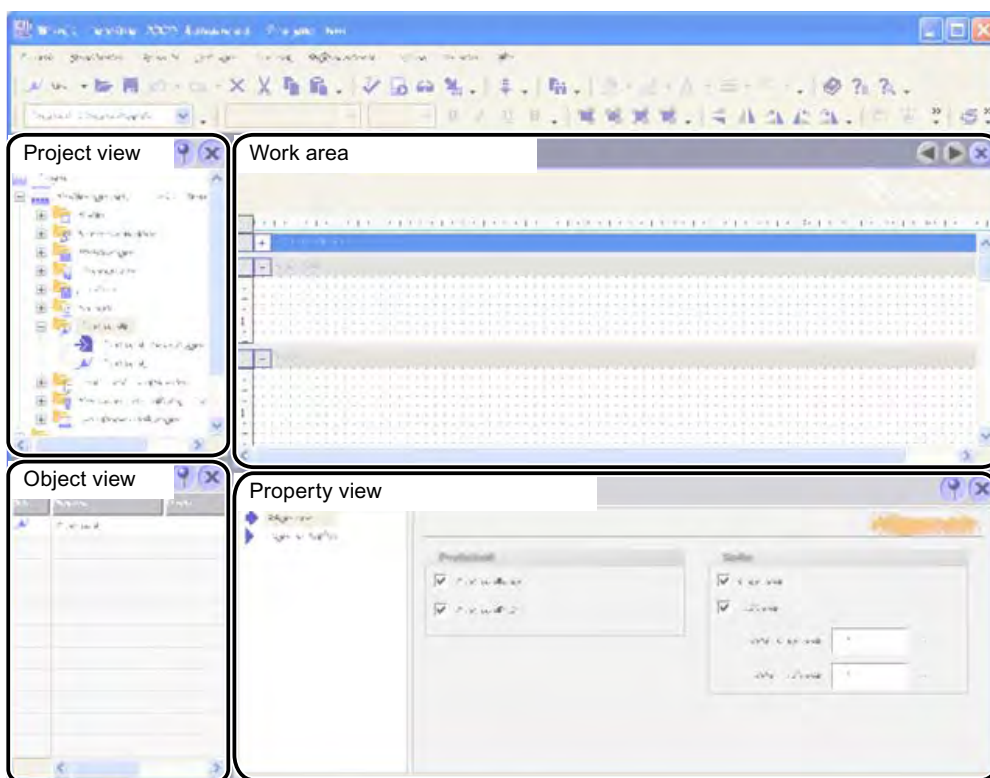

Menu bar

The menu bar contains all commands required for operating WinCC flexible. Any available shortcut keys are indicated next to the menu commands.

Toolbars

The toolbars contain the buttons most often used.

With menu "View ► Toolbars" you can display or hide the available toolbars. The  button of a toolbar is used to display or hide the individual buttons of this toolbar.

Work area

You configure the reports in the work area.

Toolbox

The toolbox gives you access to the objects required to configure a report. The objects are inserted into the report using the drag-and-drop function.

Property view

When an object is selected, you can edit the properties of the selected object in the "Property view."

When no object is selected, you can edit the properties of the active area of a report in the "Property view."

10.3.2 Using the toolbox view

Introduction

The toolbox view contains a selection of objects which you can insert into your reports in the "Simple objects" and "Report objects" groups.

If the view of a report is activated in the work area, the toolbox only displays those objects which can be used in the report. Some of the toolbox objects are either available with restricted functionality or not at all. This depends on the HMI device you are configuring. Objects not available in the toolbox are grayed out and cannot be selected.

Changing default properties

Default properties are preset for the various object types in the toolbox view. When you insert an object from the toolbox view into a report, the object takes over these default properties.

You can customize the default properties of an object type to suit the requirements of your project. When you change the default properties of an object type, the properties of objects which have already been inserted are retained. You should therefore adapt the default properties before you insert the objects.

The default properties of the objects are coupled to the user names under which you are logged on in the operating system.

In order to change the default properties, you open the pop-up menu of an object in the toolbox view. Select the command "Edit default properties." The "Properties" dialog box is displayed. Adapt the default properties of the object to the requirements of your project.

Displaying the toolbox view

With menu "View > Toolbox view" you can display or hide the toolbox view.

10.4 Working with reports

10.4.1 Creating a report

Introduction

When creating a report, you specify the individual sections and contents. Configure the contents of the following sections:

- Report header
- Page header
- Page
- Page footer
- Report footer

Configuration overview

Objects from the toolbox view are available for designing a report and configuring the data for the output. Some objects have a limited functional scope when used in a report compared to similar objects of the screen editor. An IO field can, for example, only serve as an output field.

When a report is created in the report editor, it is displayed as wysiwyg. The dynamic objects for outputting the data, for example "Print alarm" and "Print recipe", are exceptions. The configured height of these objects is irrelevant to the output format since the size of the dynamic objects depends of the existing amount of data. Page breaks are inserted consecutively on the pages depending on the amount of data. You can only insert one of these objects each into each page of a report. Objects which are positioned on the same side below one of these dynamic objects are not output. The "Print alarm" and "Print recipe" objects are inserted automatically with the width configured for the report. The width of the output follows the configured width of the report.

A new report always only contains one page. This page represents a page for the output. If required, you can insert further pages into the report. To do so, move the cursor onto the title bar of an existing page and open the pop-up menu with the right mouse button. The commands "Insert page before" and "Insert page after" are used to insert a new page before or after the existing page. The pages have a consecutive number assigned to them. A maximum of 10 pages is permitted per report. If you create more than 10 pages, the consecutive numbers of the superfluous pages are placed in pointed brackets (for example: Page <11>). The superfluous pages are not taken into consideration for the output. The "Delete page" command in the pop-up menu of a page is used to delete the selected page.

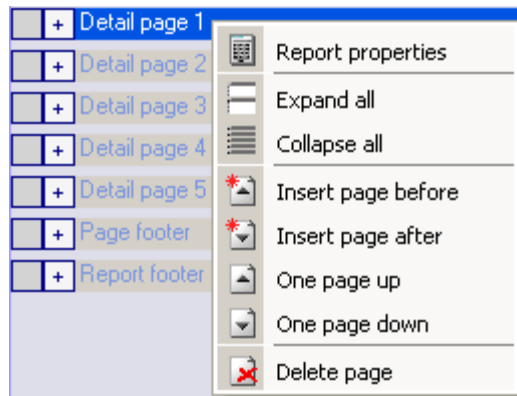

Pop-up menu of a page

The sequence of the created pages can be changed subsequently. To do so, move the cursor onto the desired page and open the pop-up menu with right mouse button. Select the corresponding command "One page up" or "One page down" in the pop-up menu. The page is moved correspondingly. The consecutive numbering of the pages is retained. If, for example, Page 4 is moved "One page up" by means of the corresponding command, Pages 3 and 4 are swapped.

The individual report sections can be closed in order to obtain a better overview in the work area. In order to minimize or maximize, click on the node before the section designation.

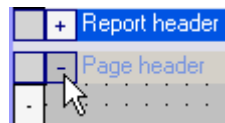

You can also display or hide all the areas simultaneously. To do so, move the cursor onto the title bar of a report area and open the pop-up menu with the right mouse button. Select the corresponding command "Display all" or "Hide all" in the pop-up menu.

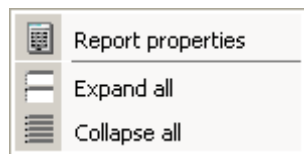

10.4.2 Adapting the report properties

Introduction

You edit the output options and the format options for the report in the report properties. The following property groups are available:

- General
- Properties/Display

Requirements

- The report whose properties are to be changed must be open.
- The property view has to be open.

Editing the report properties

To do so, move the cursor on the title bar of a report area, for example on the title bar of the "Page header." Open the pop-up menu with the right button and select the command "Document properties." The report properties are displayed in the "Property view."

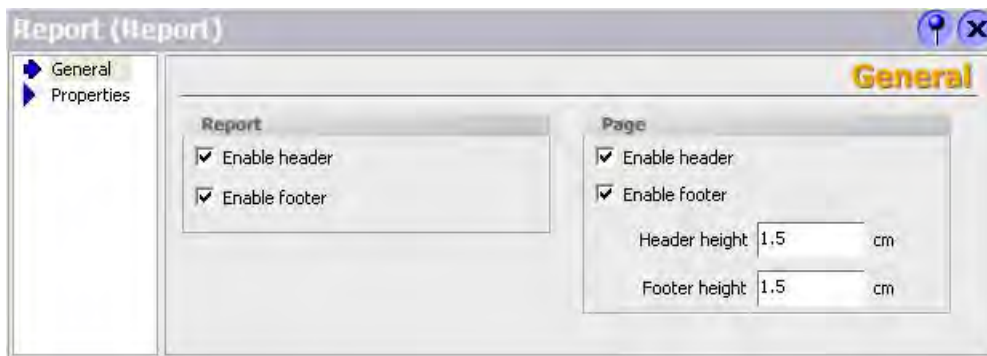

Activate the "General" properties group in the "Property view."

Activate or de-activate the output of the report header and report footer in the "Report" area.

Activate or de-activate the output of the page header and page footer in the "Page" area.

If the output of a report area is de-activated, this area is identified in the title bar by an "(X)."

Activate the "Properties/Display" properties group in the "Property view."

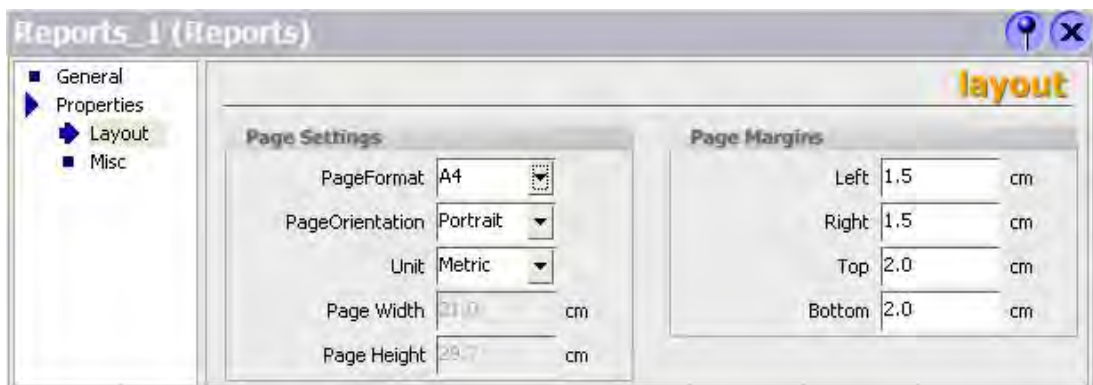

Select the page format for the output in the "Page" field.

As an alternative, select the "User defined" format. You can then enter values for your own format in the "Width" and "Height" fields.

Select the portrait or landscape format in the "Page orientation" field.

Select the unit of measurement for setting the page size and page margins in the "Unit" field.

Set the size of the page margins by using the fields in the "Page margins" area. The page margins set may not be smaller than the page margins set at the printer.

10.4.3 Objects for report creation









Introduction



Objects can be either graphics elements for laying out your project report or dynamic elements for outputting data. The objects have limitations which depend on the configured HMI device. Please note the information in the object descriptions.

The objects are made available in the "Simple objects" object group in the toolbox view.

The special report objects are also available for creating reports. The special report objects are contained in the "Report objects" object group.

Simple objects

Symbol	Object	Description
	Line	The line is an open object. The line length and angle are defined by the height and width of the rectangle enclosing the object. The line ends can be represented as arrows or dots.
	Polyline	The polyline is an open object. The surface cannot be filled even if the starting and end points have the same coordinates. A polyline can have any number of corners. The corners are numbered in the sequence of their creation and can be changed or deleted individually. The line ends of a polyline can be indicated by arrows or dots, for example.
	Polygon	The polygon is a closed object which can be filled with a color or pattern. A polygon can have any number of corners. The corners are numbered in the sequence of their creation and can be changed or deleted individually.
	Ellipse	The ellipse is an enclosed object which can be filled with a color or pattern. You can customize the width and height of an ellipse in order to align it horizontally or vertically.
	Circle	The circle is an enclosed object which can be filled with a color or pattern. The circle diameter can be adjusted freely.
	Rectangle	The rectangle is an enclosed object which can be filled with a color or pattern. The height and width of a rectangle can be varied freely in order to allow a horizontal or vertical adjustment. The corners of a rounded rectangle can be rounded off as required.
	Text Field	The field for static text is an enclosed object which can be filled with a color or pattern. The static text is entered in a text field of any size. You can enter single or multiple line text for all configured languages.
	"I/O Field"	The IO field can only be used as an output field in a report. With an "IO field" you can output values with the following data formats: Binary, date, date-and-time, decimal, hexadecimal, string and time.
	"Date-Time Field"	The date and time are output in a report with the "Date-time" field. You can output the system time or connect a WinCC flexible tag through which the "Date-time" field is supplied with corresponding values.

Symbol	Object	Description
	"Graphic IO Field"	The graphic IO field can only be used as an output field in a report. The field is used to select graphics from a graphics list. This allows you to display, for example, states of tags graphically. Example: Instead of the values 0 and 1, you can output one graphic each for a closed and an open valve.
	"Symbolic IO Field"	The drop-down list can only be used as an output field in a report. The field is used to select texts from a text list. This allows you to display, for example, states of tags in text form. Example: Instead of the values 0 and 1, you output "Motor OFF" and "Motor ON" for the state of a motor.
	"Graphic View"	The graphics object offers the possibility of inserting graphics which were created with other programs into a report. You can insert graphics or images with the following formats: "*.emf", "*.wmf", "*.dib" and "*.bmp." You define the size and properties a graphics object should have in the report.

Note



Some of the toolbox objects are either available with restricted functionality or not at all. This depends on the HMI device you are configuring. Objects not available in the toolbox are grayed out and cannot be selected.

10.4.4 Use of report objects

Introduction

Special objects are available for reports under the "Report objects" section in the toolbar. These objects are intended exclusively for use in reports.

Overview of the objects

Symbol	Object	Short description
	Page number	Outputs the page number in a report. The object only has to be inserted once in a report, for example in the page footer.
	Print recipe	Outputs recipe data in a report.
	Print alarm	Outputs alarms in a report.

10.5 Reporting alarms

10.5.1 Reporting alarms

Introduction

You configure a report in WinCC flexible with which you can output the following alarms:

- Current alarms from the alarm buffer
- Alarm from an alarm log

Procedure

Proceed as follows:

1. Add the "Print alarm" from the toolbox object to a report.
2. Select the object in order to have the properties displayed in the property view.
3. Establish from the property view the data that is to be configured.
4. Specify the alarm classes which you want to output for the selected source.
5. Specify the sequence of the alarms for the output.
6. To output the alarms of a certain interval, select the respective tags for the "Display beginning" and "Display end" fields. The tags can be supplied in runtime with the date and time for the first or the last alarm of the period.

10.5.2 Process output parameters for an alarm protocol

Introduction

You process the output parameters for an alarm protocol in the properties window. The "Print alarm" object has to be inserted in a report in order to display the properties. The property view has to be open.

Output parameters of "Print alarm"

Select the "Print alarm" object in the work area. The properties of the object are displayed in the "Property view." Select the data source and configure the selection and the layout of the data for the output in the "General" category.

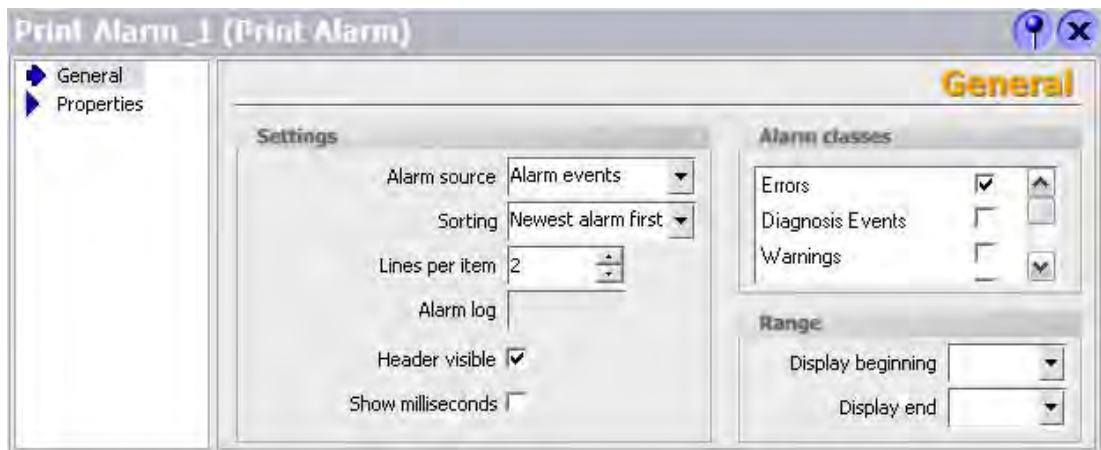

The following entries are available for outputting the alarms:

Attribute	Function	Requirement
"Source for alarms"	This is used to select the alarm source. You can select from the following options: <ul style="list-style-type: none"> • Alarm events • Alarm log 	
"Sorting"	This is used to specify the sequence for the output. You can select from the following options: <ul style="list-style-type: none"> • Oldest message first • Most recent message first 	
"Lines per entry"	This specifies the number of lines available per alarm. The required number of lines depends on the number and width of the selected columns in for the output as well as the font used and the paper format of the printer.	
"Page header visible"	Used to specify whether the table is to be output with column headers.	
"Alarm log"	This is used to select the alarm log for output.	An alarm log has to be selected as the alarm source in the "Source for alarms."
"Alarm classes"	Used to select the alarm classes for the output. You can select from the following options: <ul style="list-style-type: none"> • "Alarms" • "Alarm events" • "System alarms" • "S7 diagnostic events" 	
"Display beginning"	Used to select the first alarm for outputting the alarms of a specific period. Connect the field via the selection list to a tag. Supply the tag in runtime with a start value, for example via an input field.	The tag must be of the type "Date and time."
"Display end"	Used to select the last alarm for outputting the alarms of a specific period. Connect the field via the selection list to a tag. Supply the tag in runtime with an end value, for example via an input field.	The tag must be of the type "Date and time."

Select the "Appearance" subcategory in the "Properties" category. Configure the foreground color, the background color, the style and the font settings.



Select the "Display" subcategory in the "Properties" category. Configure the position and size of the "Print alarm" object. Select the columns for the output in the report in the "Visible elements" area.

The following columns can be output:

- "Alarm number"
- "Time"
- "Alarm status"
- "Alarm text"
- "Date"
- "Alarm class"
- "Alarm group"
- "Diagnosable"
- "PLC"

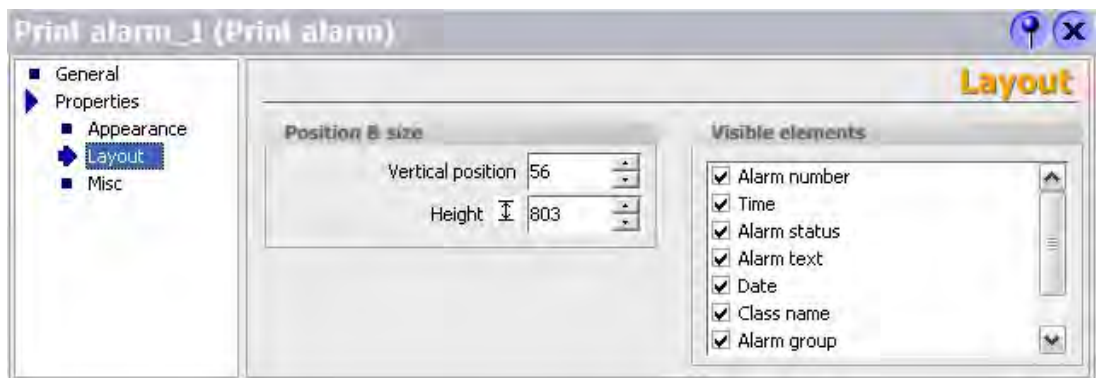

Note

The height of the "Print alarm" object configured in the report is irrelevant to the output. Since a large amount of data can occur during the report output, the "Print alarm" object is extended dynamically so that all the data arising can be output. If the page length is exceeded, an automatic page break is carried out.

10.6 Reporting recipes

10.6.1 Reporting recipes

Introduction

Configure a report of recipe records in WinCC flexible.

Output data of a recipe

In order to create a recipe report, insert the "Print recipe" object from the toolbox view into a report. Select the object in order to have the properties displayed in the property view. Configure the data selection for the report in the property view.

Specify the data selection in the "General" category in the property view. Select the recipe records for your report.

The following selections are possible:

- All the records of a recipe
- A record range of a recipe
- All the records of several or all of the recipes
- A record range of several or all of the recipes

When several recipes are selected, you can select only one range of consecutive recipes. The system uses the numbers of the recipes as an orientation. The same behavior also applies to a data record range.

Formatting for the output

In the property view, you specify in the "Properties/Display" category whether the data are to be output line-by-line or in table form. In the same category, select the record elements in the "Visible elements" area for output.

The following record elements can be output:

- "Recipe number"
- "Recipe name"
- "Data record number"
- "Data record name"
- "Tag name"
- "Tag type"
- "Element"

The report is output time-controlled or event-driven.

10.6.2 Editing output parameters for a recipe report

Introduction

The output parameters for a recipe report are edited in the property view. The "Print recipe" object has to be inserted in a report in order to display the properties. The property view has to be open.

Output parameters of "Print recipe"

Select the "Print recipe" object in the work area. The properties of the object are displayed in the "Property view." Select the recipe data for the output in the report in the "General" category.

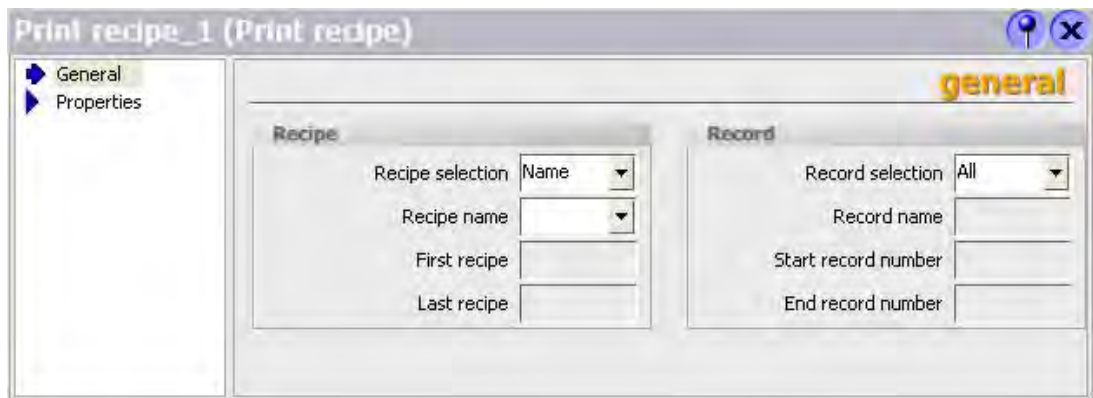

The following entries are available for the recipe selection:

Attribute	Function	Requirement
"Recipe selection"	Used to select the selection criterion for outputting the recipes. You can select from the following options: "All" "Name" "Number"	
"Recipe name"	This is used to select a recipe by its name. If you have already configured recipes, you can either enter the name of the recipe or select one from the object list.	The "Name" option has to be selected in the "Recipe selection" selection field.
"First recipe"	Used to select the first recipe number for outputting the records of several recipes. Enter a fixed starting number in the field or connect the field to a tag via the selection list. The tag can be given a start value dynamically during runtime.	The "Number" option has to be selected in the "Recipe selection" selection field.
"Last recipe"	Used to select the last recipe number for outputting the records of several recipes. Enter a fixed end number in the field or connect the field to a tag via the selection list. The tag can be given an end value dynamically during runtime.	The "Number" option has to be selected in the "Recipe selection" selection field.
"Data record selection"	Used to select the selection criterion for outputting the records of recipes. You can select from the following options: "All" "Name" "Number"	
"Data record name"	Used to select a record by its name.	The "Name" option has to be selected in the "Data record selection" selection field.
"First data record"	Used to select the first record number for outputting a record range of a recipe. Enter a fixed starting number in the field or connect the field to a tag via the selection list. The tag can be given a start value dynamically during runtime.	The "Number" option has to be selected in the "Data record selection" selection field.
"Last record"	Used to select the last record number for outputting a record range of a recipe. Enter a fixed end number in the field or connect the field to a tag via the selection list. The tag can be given an end value dynamically during runtime.	The "Number" option has to be selected in the "Data record selection" selection field.

Select the "Appearance" subcategory in the "Properties" category. Configure the foreground color, the background color, the style and the font settings.

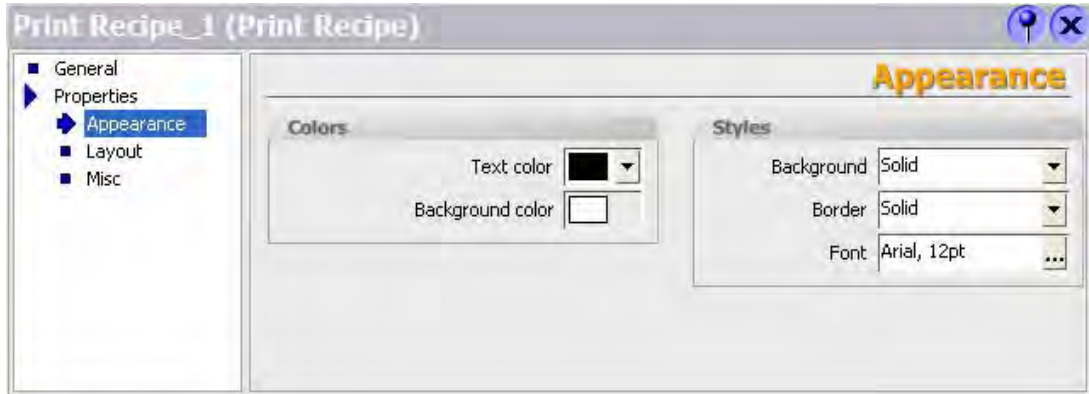

Select the "Display" subcategory in the "Properties" category. Configure the position and the size of the "Print recipe" object in the "Position and size" area. You can also use the mouse to change the size and position of the "Print recipe" object in the work area.

Select the output form as table or line-by-line output in the "Settings" area. In case of table form output, specify the number of characters for the width of the columns in the "Column width" field. The set width affects all columns of the table.

Select the record elements for the output in the report in the "Visible elements" area.

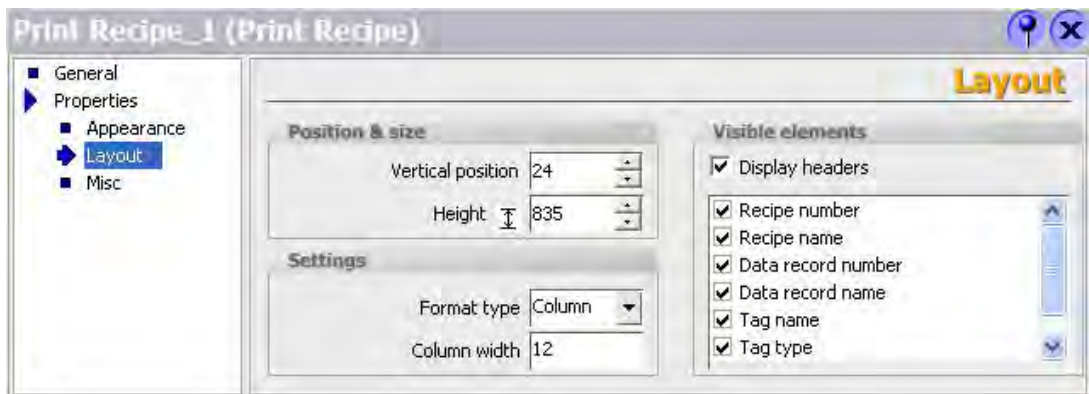

Note

The height of the "Print recipe" object configured in the report is irrelevant to the output. Since a large amount of data can occur during the report output, the "Print recipe" object is extended dynamically so that all the data arising can be output. If the page length is exceeded, an automatic page break is carried out.

10.7 Outputting a report

Introduction

WinCC flexible offers the following options for outputting a report:

Time-controlled output, for example:

- Non-recurring, time-controlled output
- Output repeated at intervals

Event-controlled output, for example:

- Through a change in the tag value
- Through activating a configured button in a WinCC flexible screen
- Overflow of a log
- Through a WinCC flexible script

Configuration of the output

Time-controlled output is configured through the scheduler. The report output can furthermore be controlled by system events which are made available by the scheduler.

Event-controlled output of an object is configured directly at a tag, a button in the WinCC flexible screen, or at a log.

Note

The output goes to the default printer with Windows-based HMI devices.

The printer is set in the Control Panel on the HMI device for Windows-CE-based HMI devices. A network printer must be accessible via the printer name. In other words, the printer must be connected to the network via a DNS server. Addressing of a network printer via the IP address is not possible at Windows-CE-based HMI devices.

User administration

11.1 Field of application of the user administration

Principle

The access protection determines the rules for access to data and functions in runtime. This protects your applications against unauthorized access. You are already limiting safety-related operations to specific user groups when you create a project. Set up corresponding users and user groups who are granted specific access rights, namely authorizations. Configure all authorizations required for operation of safety-related objects. Operators are, for example, only granted access to specific operating elements. Commissioning engineers are, for example, granted unlimited access in runtime.

Definition

You administer users, user groups and authorizations centrally in the user administration of WinCC flexible. Transfer users and user groups to the operator station, including project data. Manage users and passwords by means of the the User View on the operator station.

Application example

Configure a "Service" authorization for field service technicians who require access to setup parameters. Assign the authorization to the "Service technician" user group. All members of this group are now granted access to protected setup parameters.

CAUTION
Access protection does not protect against incorrect operations. It is entirely up to you to ensure that only personnel with appropriate training are authorized to design, commission, operate, and maintain plants and machines.
Access protection is not suitable for defining work routines and monitoring their observance.

11.2 Structure of the user administration

Introduction

In case of a project in manufacturing engineering, the environment at the equipment manufacturer has to be differentiated from the environment at the end customer as plant operator. The equipment manufacturer allows the user, for example Mr. Foreman, a specific access to the project. However, a user Foreman does not exist at the end customer.

Similar difficulties arise, for example, when different projects on a plant are to be integrated into one project in process engineering. In order to integrate the projects you have to be able to access the data of each individual project without restriction during commissioning.

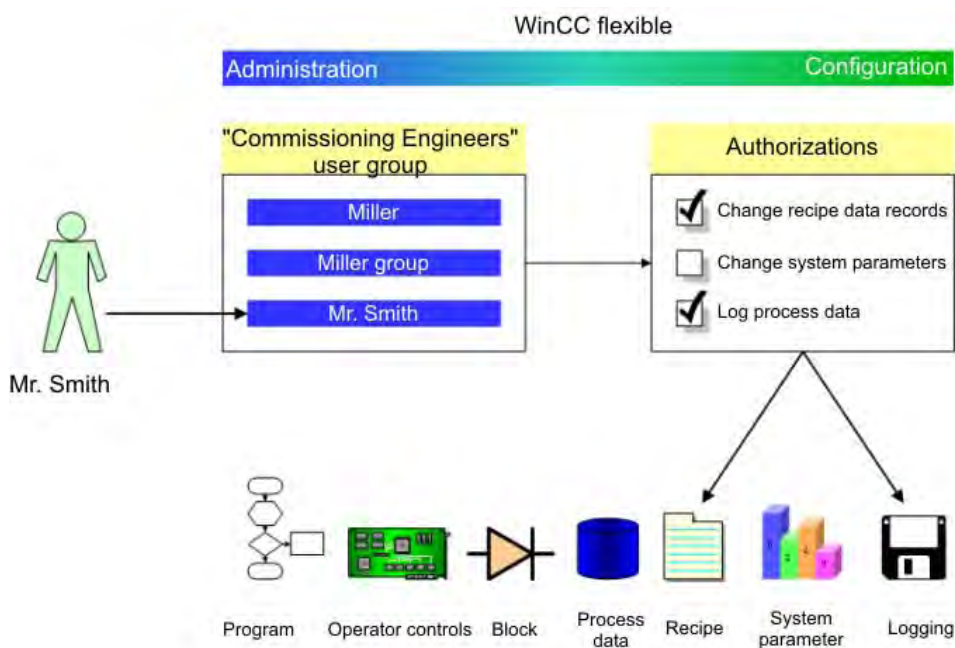

Authorizations are therefore not assigned directly to users in the user administration, but rather to user groups. A user named "Master" is assigned to the "Commissioning engineers" user group and is granted their authorizations, for example. Authorizations do not have to be assigned individually to each user, only to the user group.

In a different environment, for example at the customer, there are other users. The authorizations and user groups of the project, however, remain unchanged. Only the users are re-assigned to the user groups, for example "Commissioning engineer".

The user administration separates the administration of the users from the configuration of the authorizations. This ensures flexibility at the access protection.

11.3 Elements and basic settings

11.3.1 "Users" user administration

Introduction

In user administration you administer users and user groups in order to control access to data and functions in runtime. The user administration is divided into the administration of the users and the administration of the user groups. This section describes the administration of the users.

Open

You open the administration of the users in the project window by double-clicking on "Users."

Structure

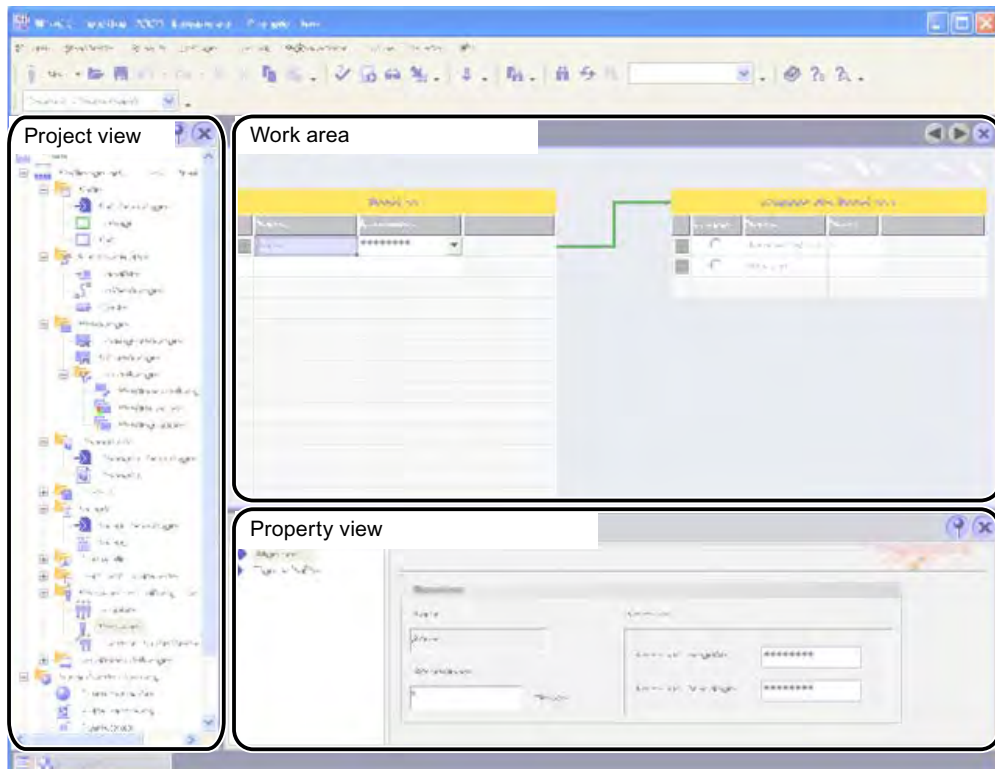

Work area

The "Users" work area shows the existing users and the user groups to which they are assigned.

Note

A user can only be assigned to one user group.

Property view

When a user has been selected, edit the password and the time after which the user is logged off automatically in the "General" group.

11.3.2 "Groups" user administration

Introduction

In user administration you administer users and user groups in order to control access to data and functions in runtime. The user administration is divided into the administration of the users and the administration of the user groups. This section described the administration of the user groups.

Open

You open the administration of the user groups in the project window by double-clicking on "Groups."

Structure

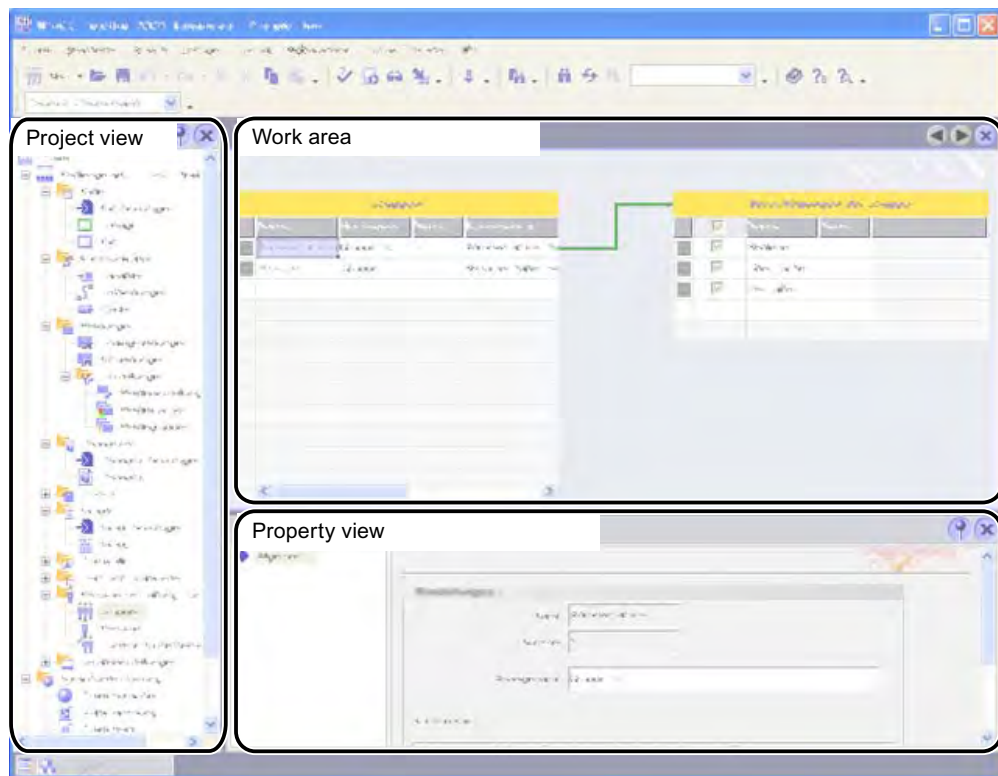

Work area

The "Groups" work area shows the existing user groups and their authorizations.

Property view

When a user group or an authorization is selected, you can edit the designation and the comment in the "General" group.

11.3.3 Users work area

Introduction

The "Users" work area lists the users and user groups in table form. You administrate the users and assign them to a user group.

Principle

The work area consists of the "Users" and "Groups of the user" tables.

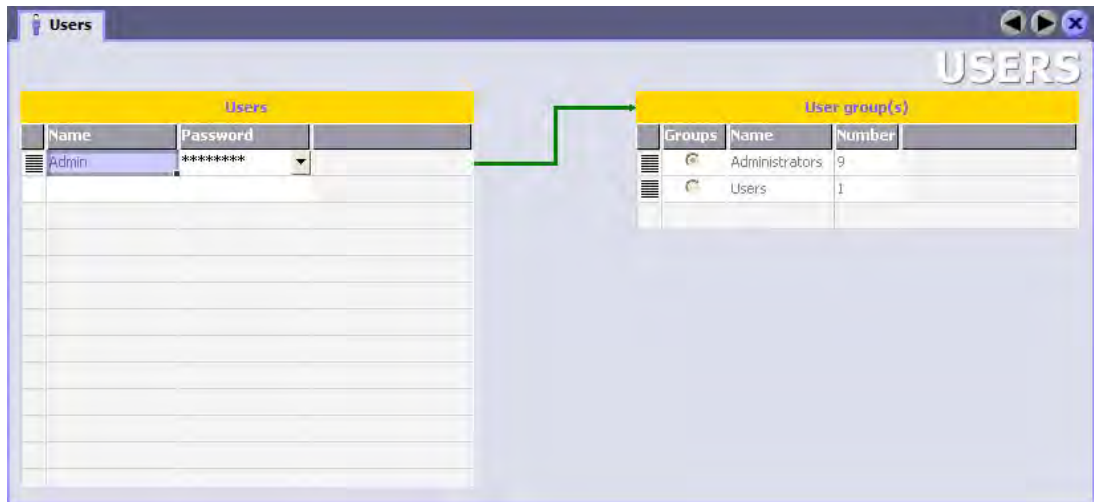

The "Users" table shows the existing users. When you select a user in this table, the "Groups of the user" table displays the user group to which the user is assigned.

11.3.4 User groups work area

Introduction

The "Groups" work area shows a table of the user groups and their authorizations. You administer the user groups and assign authorizations to them.

Principle

The work area consists of the "Groups" and "Group Authorizations" tables.

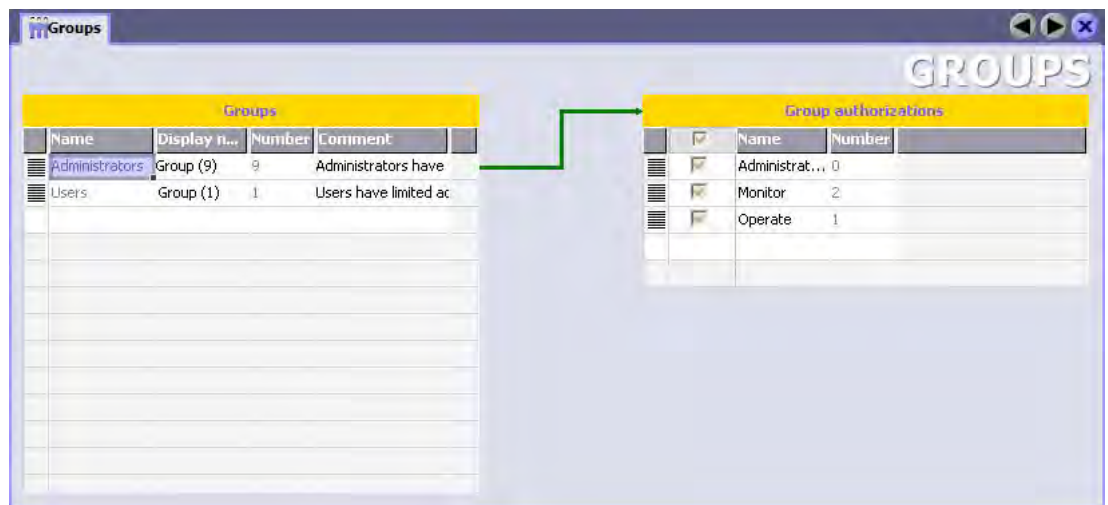

The "Groups" table shows the existing user groups. When you select a user group in this table, the "Group Authorizations" table shows the authorizations which were assigned to the user group.

The number of the user group and of the authorization is assigned by the user administration. The designations and descriptions are assigned by you.

11.3.5 Runtime security settings

Introduction

The "Runtime security settings" editor is used to configure security settings for the user passwords in runtime.

Open

In the project view double-click on "Runtime security settings" in the "Runtime user administration" group.

Structure

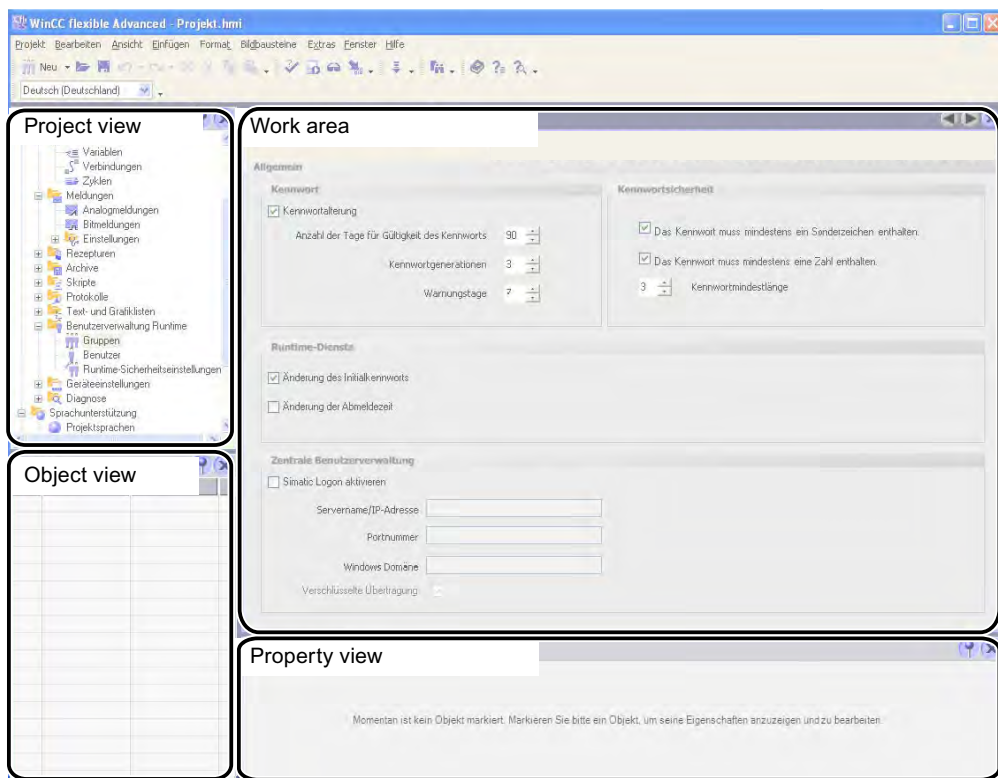

Work area

You define the expiration date of group passwords in the working area. Allow or disallow special characters or numbers in the password string and whether users only have to enter their login password.

You can also determine whether to support central user administration by using SIMATIC Logon to authorize users.

Export and import of user administration

When the user administration is exported only the current valid password of the user is included in the export file. Previous passwords are not saved.

Therefore, after import of the user administration to the HMI device the following rules apply, regardless of the runtime security settings:

- The user can retain the password assigned by the administrator when logging onto the system for the first time.
- A new password is not compared with previous passwords, because no previous passwords are available.
- The period for expiration of the password begins on import of the user administration.

An import of the user administration using the "ExportImportUserAdministration" system function is logged in the audit trail.

If the administrator is required to confirm the import of the user administration with an electronic signature or a comment, configure the additional system function "NotifyUserAction".

The export of the user administration using the "ExportImportUserAdministration" system function is not logged in the audit trail.

Note

Simulating the export of user data

During a simulation you can also test the exporting of user data. After a completed simulation, delete the export file with the password list on the PC. This ensures that nobody has unauthorized access to the passwords.

11.4 Working with the user administration

11.4.1 Central user administration using SIMATIC Logon

Introduction

Activate SIMATIC Logon to manage users and user groups centrally for several applications or HMI devices.

Principle

SIMATIC Logon is a tool for system-wide user administration. Users of external applications or HMI devices are managed centrally using the SIMATIC Logon application.

Configure the user groups and corresponding authorizations as in the local user administration of WinCC flexible. Assign the user groups identical names on the server and in WinCC flexible. Based on this identical naming, users are assigned the corresponding authorizations of the user group in Runtime.

Create the users on the domain server. The data of users who log on in Runtime is aligned dynamically with the server. Users known on the server are assigned the corresponding authorizations of the user group. The application or the HMI device transfers any logon request or password change by means of SIMATIC Logon to the server for processing.

Note

SIMATIC Logon is a product requiring a license. For more information on SIMATIC Logon go to <<http://support.automation.siemens.com>>.

In the search field, enter the ID "22657587" and start searching. The "SIMATIC Logon - Electronic Signature" manual is available to download.

Log on process via SIMATIC Logon Service

The following diagram illustrates the process that runs automatically when a user logs onto Runtime.

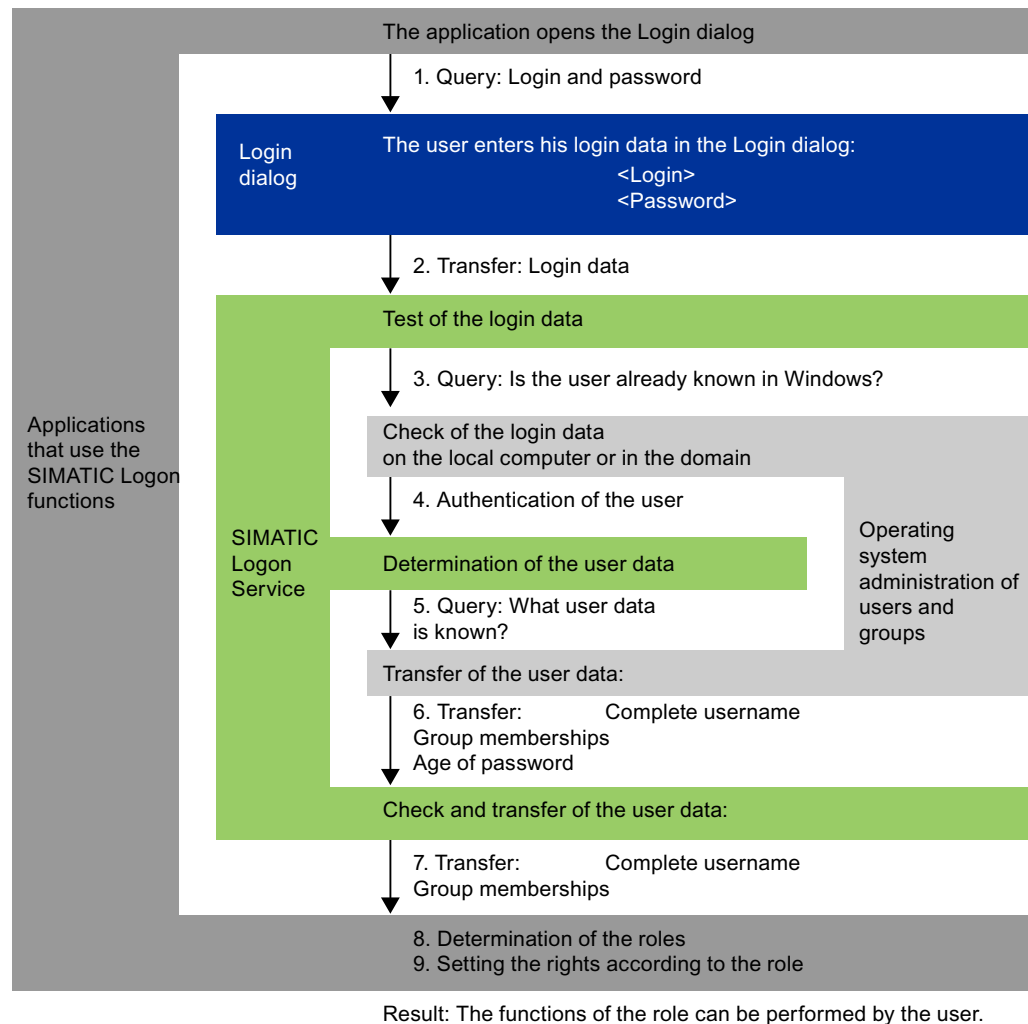

11.4.2 Users in Runtime

Principle

In the engineering system you create users and user groups and allocate authorizations to them. You configure objects with authorizations. After transfer to the HMI device, all objects which were configured with an authorization are protected against unauthorized access in Runtime.

User view

When you configure a user view in the engineering system, you can administer users in the user view following transfer to the HMI device.

CAUTION
Changes in the user view are effective immediately in runtime. Changes in runtime are not updated in the engineering system. When the users and user groups are transferred from the engineering system to the HMI device, all the changes in the user view are overwritten after a user prompt and based on the transfer settings.
Some HMI devices do not support the user view. These HMI devices only support the functions "Log on" and "Log off": The only user "Administrator" is logged on and logged off. The "Administrator" is assigned to the only user group "Administrators."

Exporting and importing user data

The users and passwords existing at an HMI device are exported and imported to a different operator panel by means of a system function. This ensures that the user administrations of the different HMI devices have the same status.

Note

Once you have exported the user data with WinCC flexible 2004, you can then import this file into WinCC flexible 2005.

Once you have exported the user data with WinCC flexible 2005, you cannot then import this file into WinCC flexible 2004.

11.4.3 User view

Purpose

You configure a user view in the engineering system in order to also administer the users in runtime.

Introduction

The users and user groups are created in the engineering system and transferred to the HMI device. Users who have the "Administration" authorization have unlimited access to the user view to administer all users. Any other user has only limited access to the user view in order to administer himself.

CAUTION

Changes in the user view are effective immediately in runtime. Changes in runtime are not updated in the engineering system.

When the user and user groups are transferred from the engineering system to the HMI device, all changes in the user view will be overwritten.

Layout

The user view shows the user, his/her password, the user group to which he/she belongs and the log off time in each line.

User	Password	Group	Logoff time

Note

If no user is logged on, the user view is empty. Clicking in the user view opens the logon dialog box. The content of the individual fields is displayed after logon.

User view of an administrator

User	Password	Group	Logoff time
Admin	*****	Group (9)	5
PLC User	*****	Group (1)	5
User 1	*****	Group (1)	5

When an administrator is logged on, the user view shows all the users. The administrator changes the user name and the password. The administrator creates new users and assigns them to an existing user group.

User view of a user

User	Password	Group	Logoff time
Miller	*****	Users	5

When no administrator is logged on, the user view shows only the logged-on user. Users can change their own passwords. To change the name, the user has to be logged on as administrator.

Note

When a SIMATIC logon user is logged in, the domain is shown in addition to the user name.

11.4.4 Access security

Introduction

You configure an authorization at an object in order to protect it against access. All logged-on users who have this authorization can access the object. When a user does not have authorization to operate an object, the logon dialog is displayed automatically.

Note

Several system functions are available under "User administration" so that user, password and user group can be edited, for example, in the control system.

System functions and runtime scripting

12.1 Basics

12.1.1 System functions and runtime scripting

Introduction

WinCC flexible provides predefined system functions for common configuration task. You can use them to perform many tasks in Runtime and need no programming skills to do so.

You can use runtime scripting to solve more complex problems. Runtime scripting has a programming interface which can be used to access part of project data in runtime. The use of runtime scripting is aimed at project planners with knowledge of Visual Basic (VB) and Visual Basic Script (VBS).

Use of system functions

System functions provide support if you wish to assign a function to an operating element:

- Set a bit in the PLC
- Change the value of a tag
- Start logging

System functions can be configured in function lists and scripts.

Note

If you configure a function or script at the "Value change" event of an internal tag, they will not be executed under certain constellations.

Example:

The function `IncreaseValue(V,+1)` is configured at the value change event of an internal tag "V".

Version 1:

The same function "`IncreaseValue(V,+1)`" is configured at a key. If you press the key, the value of the tags V is changed.

If the function at the value change of "V" is executed, the constantly mutually abutting functions make the HMI device inoperable. This is why the execution of the function is prevented.

Version 2:

When you make an entry in an input field, the value of the tags V is changed. In this case the "`IncreaseValue(V,+1)`" function is executed exactly once.

Use of runtime scripting

Runtime Scripting is available from OP 270/TP 270 and therefore also from WinCC flexible Standard. VBScript is supported as a programming language. The use of runtime scripting allows flexibility in the realization of configurations. Create scripts with Runtime scripting if extra functionality in runtime is needed, e.g.:

- Conversion of values

You can use scripts to convert values between different measurement units, e.g. temperatures.

- Automation of production sequences

A script can control a production sequence by transferring production data to a PLC. The status can be checked with the return values and, if necessary, appropriate measures can be taken.

Scripts

You can save your own VB script code in a script. You can use the script just like a system function in the project. You have access to the tags of the project and the runtime object model of WinCC flexible in the script. In addition, you can use all standard VBS functions in the script. You can call other scripts and system functions in the script.

Execution of system functions and scripts

System functions and scripts are executed in runtime after the onset of a configured event (e.g. a mouse click on a button).

Recursion level

The recursion level in scripts is limited by the stack size of the HMI device. In Runtime, an unrestricted number of recursions leads to a system error message. Therefore, please limit the number of recursions in a script.

12.1.2 System functions

Introduction

System functions are pre-defined functions you can use to implement many tasks in runtime even without having any programming knowledge, such as:

- Calculations, such as increasing a variable value by a specific or variable amount.
- Logging functions, for example starting a process value log.
- Settings, for instance changing the PLC or setting a bit in the PLC.
- Alarms, for example after a different user logs on.

Application

You can use system functions in a function list or in a script. You cannot change system functions, since system functions are pre-defined functions.

When configuring a function list, select the system functions from a selection list that is sorted by categories:

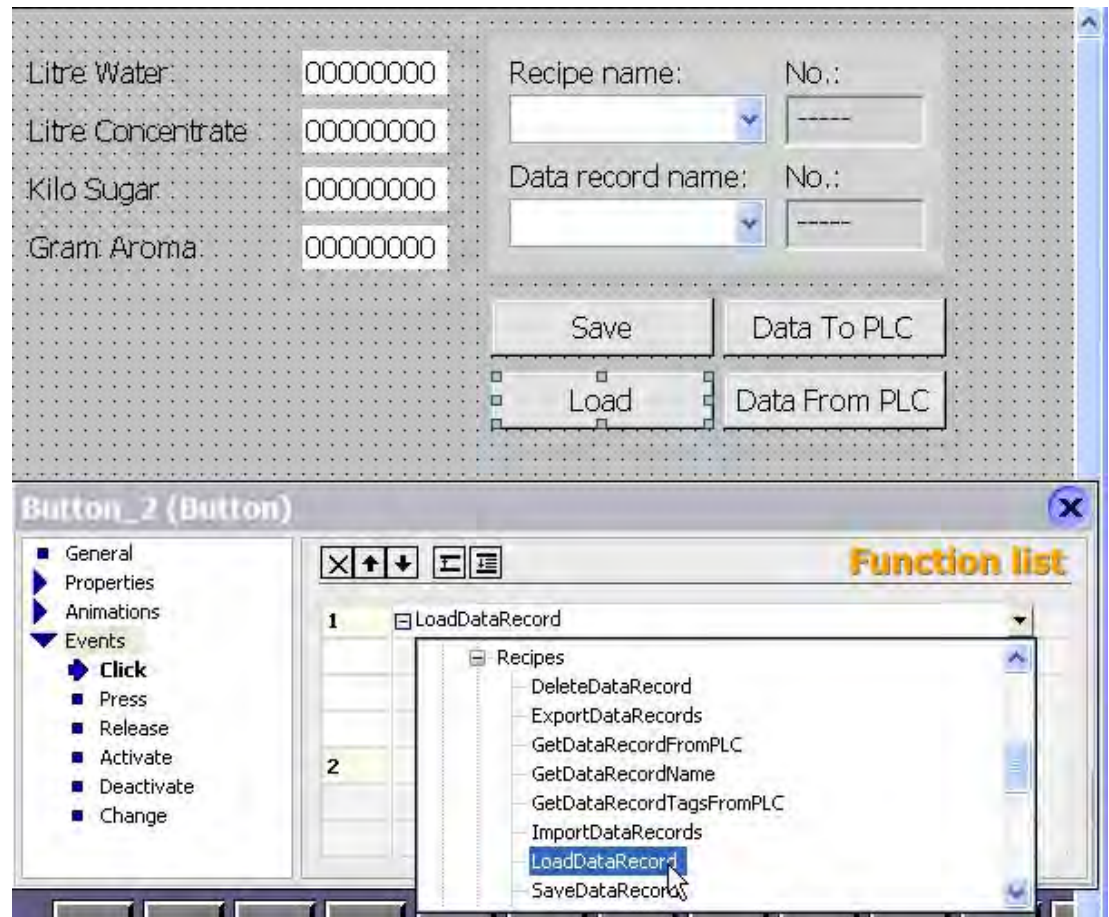

When you want to use a system function in the script, you can select it from a selection list. You can call up the selection list in the script with <Ctrl+Space>.

Language dependency

The names of the system functions are dependent on the set project language. The functionality can then be recognized immediately by the project planner.

Exception: When calling up system functions in a script, please use the English name for the system function. You can find the English name of the system function in the system function reference.

Availability

In WinCC flexible you can only configure functionalities which are supported by the selected HMI device. Therefore, in a function list you can configure only system functions which are supported by the selected operating unit. If you use a project for several operating units, the system functions that are not supported by an operating unit are marked in color.

12.1.3 Use of system functions

Introduction

A function list is processed when a configured event occurs in runtime. The operator can trigger an event, for instance by pressing a function key on the HMI device. An event can also be triggered by the system, for instance if a process value falls below a limit value.

Applications

You can configure system functions on all the objects that are able to react to an event. You can use system functions directly in function lists and scripts and thereby control the course.

- Function List

System functions are processed sequentially in a function list, that is, from the first to the last system function. In order to avoid waiting times, system functions with a longer running time (for instance file operations) are processed simultaneously. For instance, a subsequent system function can already be performed even though the previous system function has not yet been completed.

An example for the configuring of a function list can be found under "Example: Changing the operating mode on the HMI device with the current display.

- Script

In a script you are able to use system functions in connection with orders and requirements in the code. This way, you can execute a script depending on a specific system state. In addition, return values of system functions can be evaluated, for example. Depending on the return value, test functions can be carried out, for example, which in turn affect the course of the script.

12.1.4 Scripts

Introduction

You program VB script codes in a script. You can use finished scripts in the project just like a system function. When creating a script, you determine its type and define transfer parameters. Scripts of the type "Function" have a return value. Scripts of a type "Sub" are referred to as procedures and have no return value.

Properties of scripts

You can call up other scripts and system functions in a script. You can access the runtime objects of WinCC flexible by using the runtime object model. When calling up a system function, please use the English name of the system function. You can use the full scale of language from Microsoft VBScript in scripts. Functions and methods for user interaction are excluded, for instance "MsgBox".

If you use system functions in a script which are not available on the set operating unit, you will receive a warning message. In addition, the respective system function in the script will be underlined with a wavy blue line.

Organization of scripts

Scripts are stored in the project database. The available scripts are listed in the project view under scripts.

If you want to use a script in a function list, you can find the scripts in the selection list under scripts.

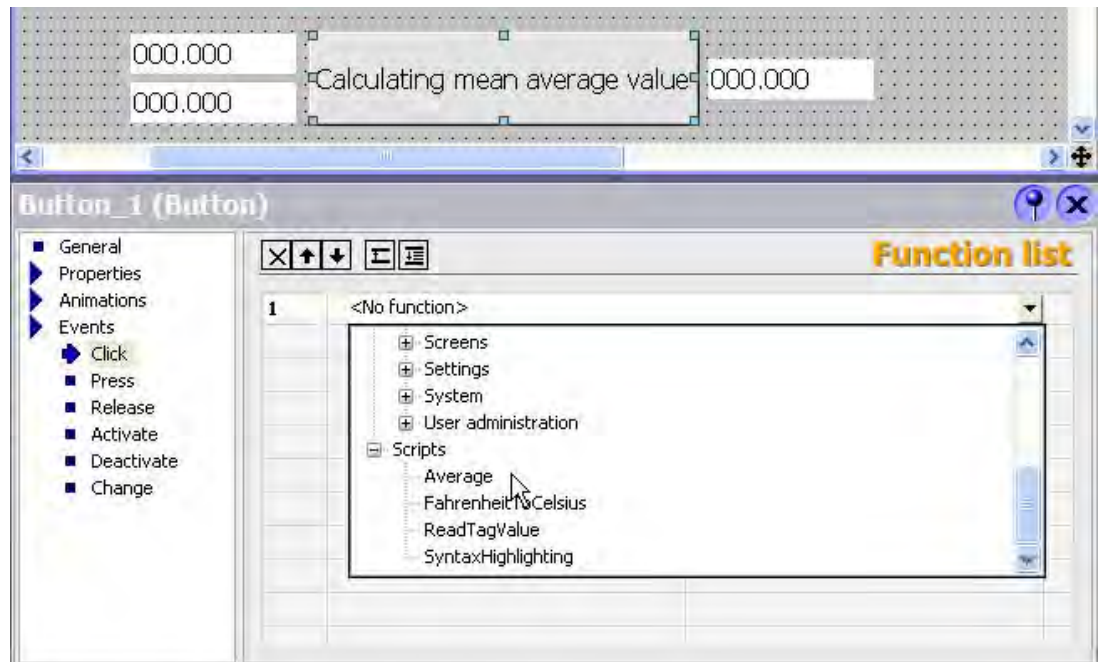

12.1.5 Use of scripts

Principle

Scripts provide more flexibility by using control elements of a programming language.

Using scripts in runtime, you implement individual solutions in a project, for instance:

- Configuring an advanced functions list

You use a script just like a function list by calling up system functions and other scripts in the script.

You can execute system functions and scripts in the script dependent on conditions, or have them repeated. You then add the script to a functions list.

- Programming new functions

Scripts are available in the entire project. You use scripts just as you would system functions. You can define delivery parameters and return values for these scripts. You use scripts, e.g. to convert values.

12.2 Working with function lists

12.2.1 Basic principles of the functions list

Introduction

When the configured event occurs, several system functions and scripts can be performed with the function list.

Principle

The function list is configured for an event of an object, such as a screen object or a tag. The events which are available depend on the selected object and the HMI device.

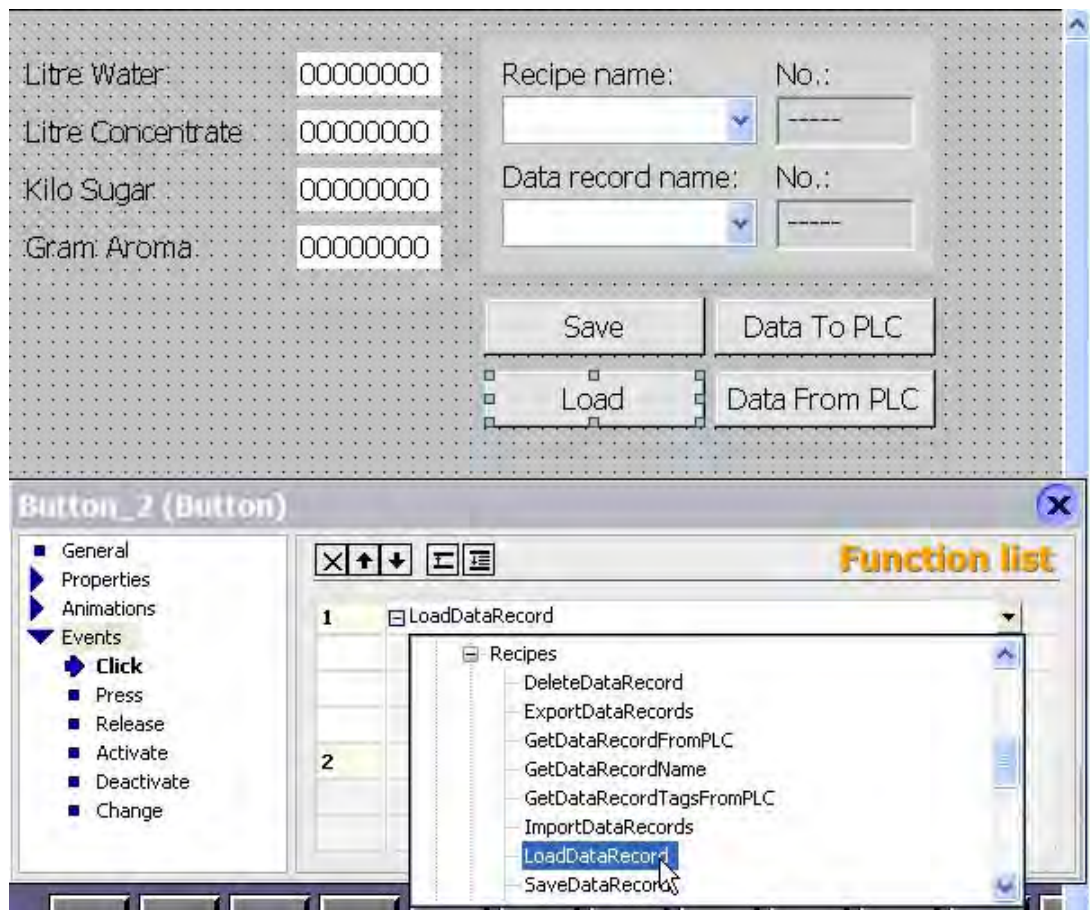

Events occur only when the project is in runtime. Events include:

- Value changes of a tag
- Changing the value of the array = changing the value of an array element
- Pressing of a button
- Activation of runtime

You can configure a function list precisely on every event.

Note

The choice of configurable system functions in a function list is dependent on the HMI device chosen.

12.2.2 Properties of a function list

HMI device dependency

You can use a project for different HMI devices. When you change the HMI device in a project, all system functions and scripts which are not supported by the selected HMI device are marked in yellow. The system functions which are not supported will also not be performed in runtime.

Status information

During configuration the project data is tested in the background. A status information returns in each function list the status of the respective system functions and scripts.

The status information has the following meaning:

- Orange: Function list is not performed in runtime because at least one system function or a script has not been supplied completely with parameters.
- Yellow: Function list is performed in runtime. However, the function list contains at least one system function or script which is not supported by the HMI device (e.g. due to the change of device type).

Completion of system functions and scripts

System functions and scripts in a function list are processed in runtime sequentially from top to bottom. In order to avoid waiting times, system functions with a longer running time (for instance file operations) are processed simultaneously. For instance, a subsequent system function can already be performed even though the previous system function has not yet been completed.

To avoid programming sequential and conditional procedures, use a script with loops, conditional statements and cancellation requirements.

12.3 Elements and basic settings

12.3.1 "Script" editor

Introduction

Create and edit scripts in the script editor.

Open

The Script editor opens automatically if a new script is created or an existing script opened.

Layout

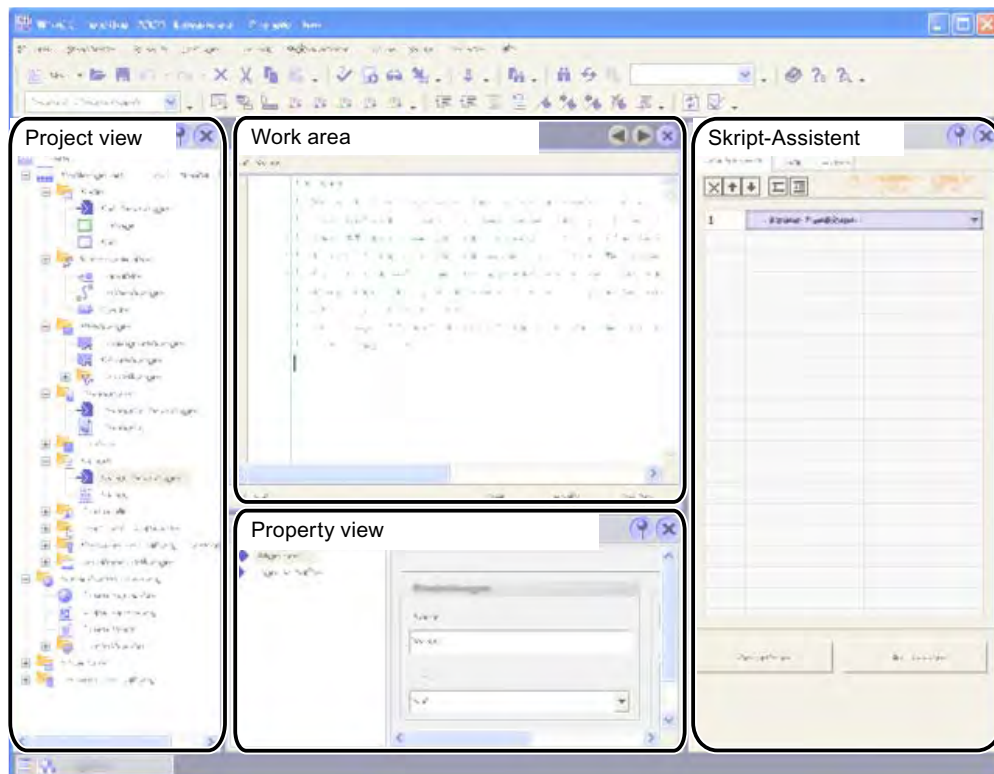

Menu bar

The menu bar contains all commands required for operating WinCC flexible. Any available shortcut keys are indicated next to the menu commands.

"Scripts" toolbar

The commands for synchronizing objects and tags as well as for checking script syntax are located in the "Script" toolbar.

"Advanced Edit" toolbar

The commands for the following actions are located in the "Advanced edit" toolbar:

- Working with bookmarks
- Indenting and outdenting code
- Commenting on code
- Jumping to a specific code row

"IntelliSense" toolbar

The commands for displaying selection lists, e.g. all objects of the object model, available system functions or VBS constants, are found in the "IntelliSense" toolbar.

Work area

Create and edit scripts in the work area. The creation of scripts is supported by syntax emphasis and IntelliSense.

Property view

Configure the script in the property view. You determine whether the script is a procedure or a function. Furthermore you can declare parameters for the script.

"Script Wizard"

In the "Script Wizard" system functions and scripts can be set up with assigned parameters just as in a function list. The filed system functions and scripts can also be transferred to the active script from the "Script Wizard". In this way, you only need to perform the parameter assignment once.

If system functions or scripts have already been configured on an event, these may be transferred to the "Script Wizard" using copy and paste. Only system functions which are allowed in a script may be filed in the "Script Wizard." When you transfer system functions which cannot be used in a script using copy and paste, these system functions will be marked.

12.3.2 Properties of the "Script" editor

Introduction

The script editor supports you during programming with functionalities such as IntelliSense, emphasized syntax, and others. For example, references to tags can be created with the drag-and-drop function.

IntelliSense

When you access objects, methods or properties of the VBS object models, you are supported by IntelliSense:

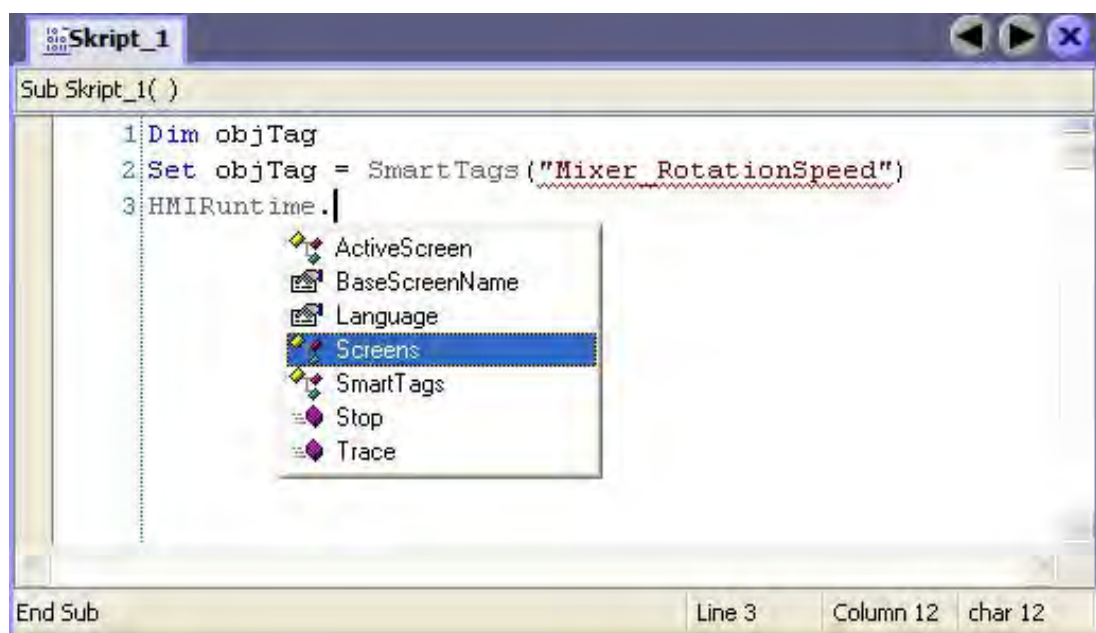

The methods and properties which the given object possesses can be selected from the selection list.

Syntax emphasis

In the script editor, keywords are emphasized by different colors. Objects which the script editor recognizes are displayed in bold. Unknown words are underlined with a red wavy line:

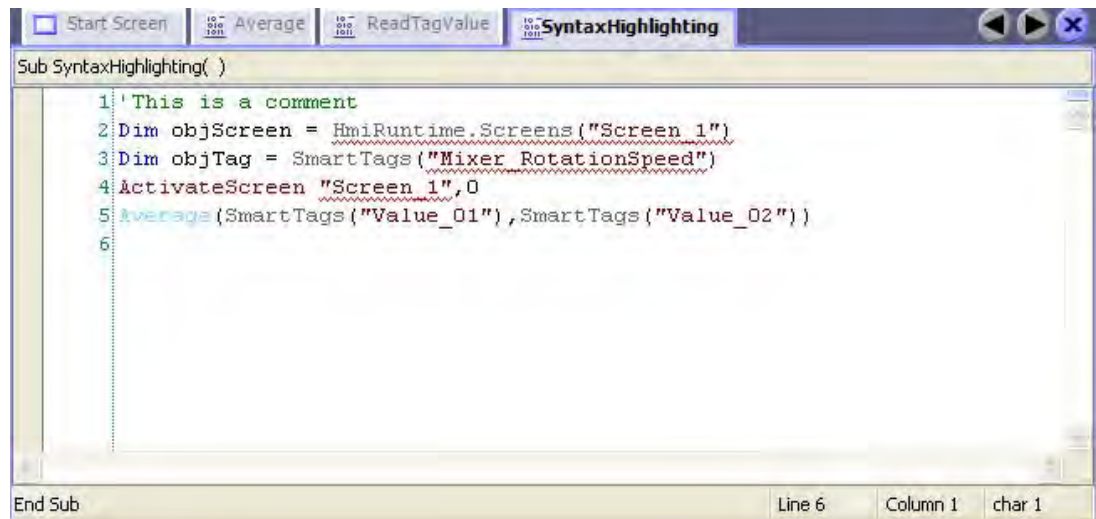

The table shows the pre-set colors for the most important keywords.

Color	Meaning	Example
Blue	Keyword (VBS)	Dim, If, Then
Gray	Keyword (object model)	HmiRuntime
Cyan	Script	FahrenheitToCelsius
Brown	System function	IncreaseValue
Red	Tag	Tag_1
Green	Comment	'This is a comment'

Synchronization of objects

When opening the script, instances of objects (e.g. tags) are automatically synchronized with the configuration data. If a tag has been renamed in the "Tag" editor, e.g., this change also affects the script. When change is made and the affected script is open, the renamed object will be underlined with a blue wavy line. The synchronization can then be performed manually in the script editor.

Object list

Using the key sequence <Alt+Right>, the object list can be called up in which all available objects are displayed depending on the context. The object lists can be called up during the assignment of parameters, e.g., or when using listings.

Example: You want to reference an existing process screen by means of the screen list. Enter "HmiRuntime.Screens" in the Script editor and then call up the object list with <Alt+Right>. All existing process screens in the project are listed for you in the object list:

Select the desired process screen and take on the selection with <Return>.

Drag-and-drop

If a tag is required in the script, it can be pulled from the object window.

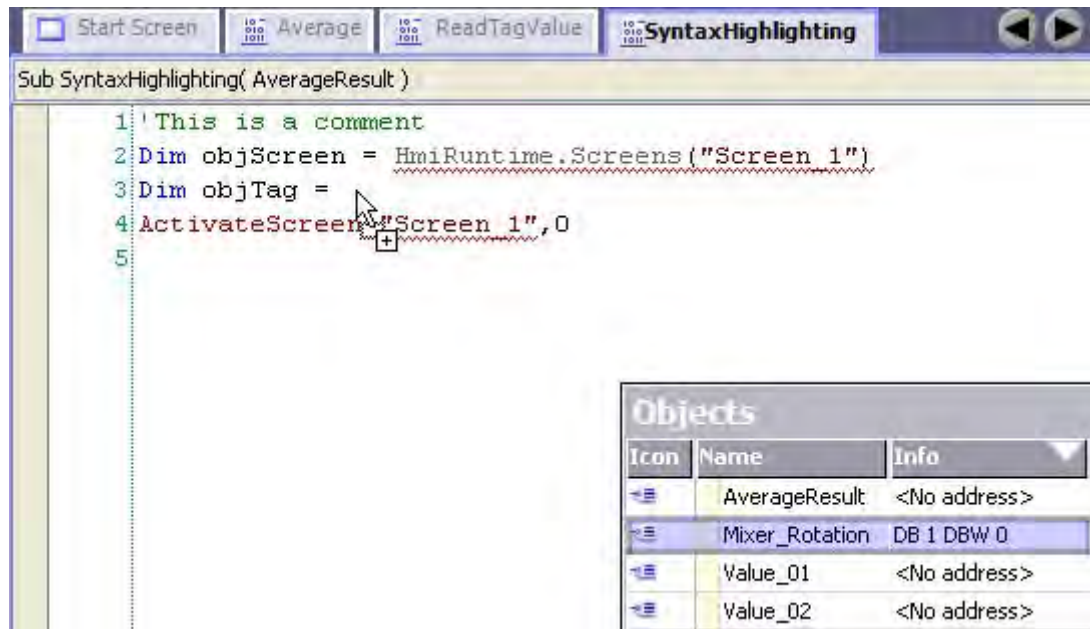

Help functions

During programming you will be shown automatically short descriptions of the necessary parameters for the methods and system functions. In addition, the following help functions are available in the script editor:

- Tooltip

Unknown or incorrectly written keywords will be underlined with a wavy line. When you move the mouse over a keyword, Tooltip appears:

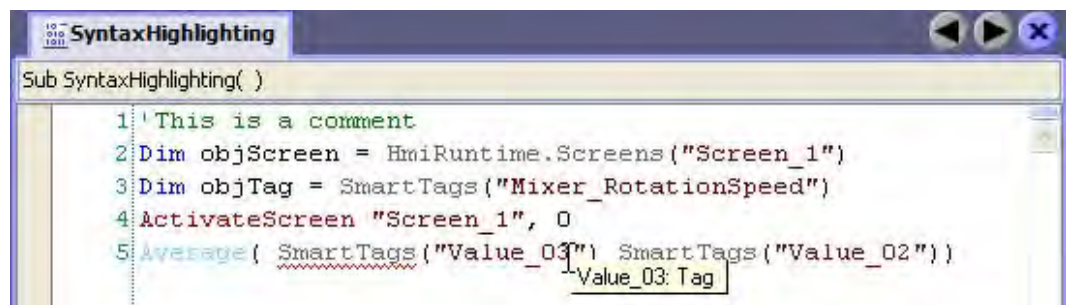

For known keywords, Tooltip shows the type of keyword.

- ParameterInfo

The ParameterInfo offers information concerning the syntax and the parameters of a system function or a VBS standard function.

- Context sensitive help

The context sensitive help offers information concerning system functions, VBScript language elements, objects, etc.

If information about an object, a method or a property is needed, move the mouse pointer over the corresponding keyword and press <F1>. This allows you to reach the corresponding reference description in the online help.

12.3.3 Basic settings

Introduction

You can adjust the basic settings of the script editor individually. Select the command "Settings" in the "Tools" menu. Change the basic settings in the "Scripts" group.

Change editor settings

The editor settings in the script can be changed. For example, you can stop the display of the infotext in the script.

In order to change the editor settings, click on the "Editor settings" entry in the "Scripts" group.

Changing syntax emphasis

The pre-set color for every text element can be changed. Click on the "Fonts and Colors" entry in the "Scripts" group.

Select the desired text element in the "Text element" selection list. Then select the desired color or define a new color.

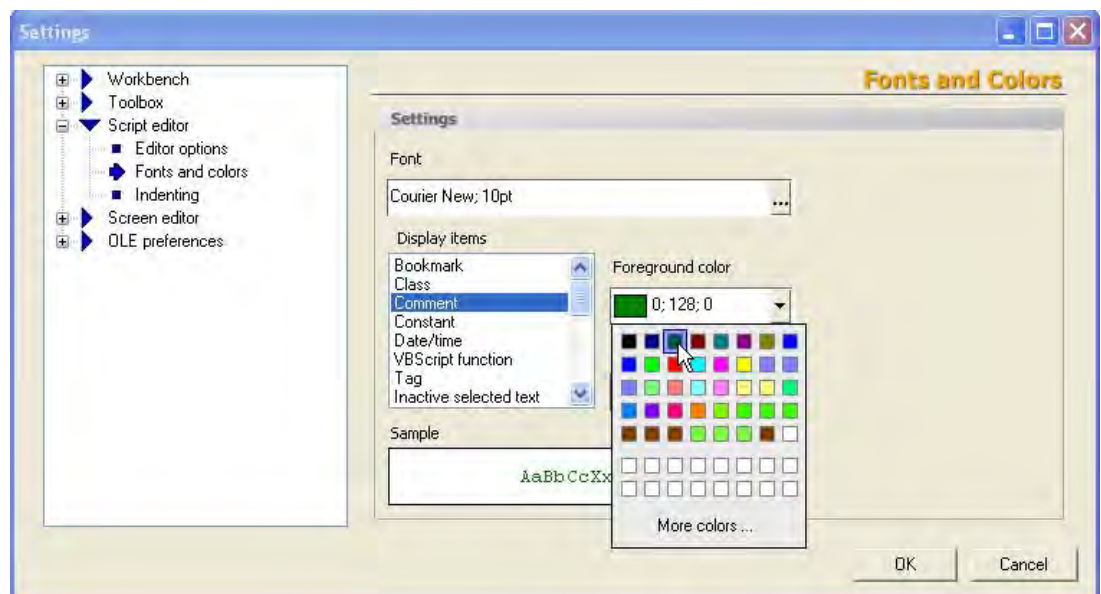

Change code formatting

Code formatting can be changed as follows:

- In order to change the type and size of font, click on the "Fonts and Colors" entry in the "Scripts" group.
- In order to change the indentions and tab stops, click on the "Indent" entry in the "Scripts" group.

Settings when transferring to an HMI device

Using the following device settings for the runtime, memory space on the HMI device is saved after the transfer of scripts:

- Transfer name information
- Display script comments

Numbers instead of object names are transferred. Use this setting only if scripts are tested and free of errors. When scripts are tested in the debugger, the code will become more clear due to the display of object names and comments.

12.4 Creating scripts

12.4.1 Access to tags

Introduction

In the script you have access to external and internal tags which you set up in the project. The value of a tag can be read or changed in runtime.

Furthermore, you can set up local tags as a counter or as buffer storage in the script.

The script fetches the value of the external tag from Runtime memory. At the start of Runtime, the actual value will be read from the PLC and written to Runtime memory. Next, the tag value will be updated to the set cycle time. The script first accesses tag values read from the PLC at the previous scan cycle checkpoint.

Project tags

If the tag name in the project corresponds to the VBS name conventions, the tag can be used directly in the script:

```
'VBS_Example_03  
If BeltDriveOilTemperature > 100 Then [instruction]
```

If the tag name in the project does not correspond to the VBS name conventions, then the tag must be referenced by means of the "Smart tags" list. In the following example, the tag name contains the & sign, which is not allowed according to VBS name conventions:

```
'VBS_Example_04  
SmartTags("Test&Trial")= 2005
```

The VBS name conventions are found in the help for VBS in the information system.

Local tags

Local tags can be defined in the script using the Dim statement. Local tags can be used only within the script. Therefore, they do not appear in the "Tags" editor.

For example, in the script a local tag is used as counter in a Forstatement.

```
'VBS_Example_05  
Dim intCount  
For intCount = 1 To 10[Instruction]Next
```

Note

You have to use a local tag if you need a tag for a "For." Project tags are not allowed within a "For."

Access to tags in a script

If, in the script, you use a tag the name of which is only compiled during the running time in the script, then configure this tag with the "Cyclically continued" acquisition mode.

If you configure the tags with "Cyclic on use" acquisition mode, you must ensure that the script is only called in the screen where the tag is also used at another instance such as an IO field.

Note

A script tag is only known in the script. To use the value of the script tag outside the script, interconnect it with an internal or external tag.

A script tag can have an undefined value. WinCC flexible does not support the assignment of undefined values to internal or external tags.

12.4.2 Call up of scripts and system functions in the scripts

Principle

System functions and other scripts can be called up in a script.

Call up a system function or a script without return value ("Sub") as follows:

```
<Function name> [Parameter1], [Parameter2], [...]
```

A system function or a script with return value ("Function") is called up by means of assignment to an expression:

```
<Expression> = <Function name> ([Parameter1, Parameter2,...  
[Parameter N])
```

If you do not want to evaluate the return value, use the call up as you would for a system function or a script without return value.

Particularities when calling up system functions

You can insert system functions and scripts into the script from the "Script Wizard." The system functions are displayed in the currently configured language in the "Script Wizard."

When calling up a system function in the script, always use the English name of the system function:

```
SetValue Tag1, 64
```

You can find the English name of the system function in the system function reference under "Syntax." The set project language is not taken into consideration.

The following rules apply to the parameter delivery for system functions:

- Constants.

If you use a constant as a parameter, then the parameter type must correspond to one of the three data types: Integer, double or string. The available constants are shown in a selection list when assigning parameters. The usual VBS conventions apply to constants.

- Tags

Independent of the spelling, tags are always delivered as "Call by reference." When the tag to be delivered corresponds to the VBS name conventions, the tag name can be delivered without the keyword SmartTags:

```
SetValue Tag1, 64
```

or

```
SetValue SmartTags("Tag1"), 64
```

- References to objects, e.g. process screens, connections and logs

An object reference is delivered as parameter in quotation marks:

```
ActivateScreen "MainScreen", 0
```

Particularities when calling up scripts

When calling up a script, parameters are delivered as "Call by Reference." When you pass a tag as a parameter, for example, the value assignments in the script have an immediate effect on the value of the tag.

Operator device dependency in the script

The code of the script is dependent on the selected operator device. If system functions are used in the script that are not supported by the selected operator device, an error message is received in the output window.

12.4.3 Access to objects

Introduction

The objects of the runtime object model with the accompanying properties and methods are available to you in the script.

The object properties can be read and changed in runtime.

Referencing objects

In the script, reference objects by means of the accompanying list. To identify the object, use its name or the position number within the list.

The first object in the screen "MainScreen" is referenced with the following statement:

```
'VBS_Example_01
Dim objObject
'Change to Screen "MainScreen"
HMIRuntime.BaseScreenName = "MainScreen"
Set objObject = HMIRuntime.Screens(1).ScreenItems(1)
```

An object is referenced by means of its name and an object property is changed with the following statement: In order to do this, the object must be set up with this name in the screen.

```
'VBS_Example_02
Dim objCircle
HMIRuntime.BaseScreenName = "MainScreen"
Set objCircle = HMIRuntime.Screens(1).ScreenItems("Circle_01")
objCircle.BackColor = vbGreen
```

12.4.4 Synchronization of tags and objects

Introduction

When an object name is changed in WinCC flexible, the change affects the entire project. Such changes are identified as "Synchronizing" in the script.

Application example

In the tag editor you defined the tag "Oil Temperature" which you want to use in a script. During the configuration rename this tag "OilTemperatureMotor1" in the tag editor.

- Script was open during renaming:

The old tag name is underlined by a blue wavy line in the script. When you move the mouse pointer over the tag name, Tooltip appears. When you click on the button "Synchronize", the tag is renamed in the script:

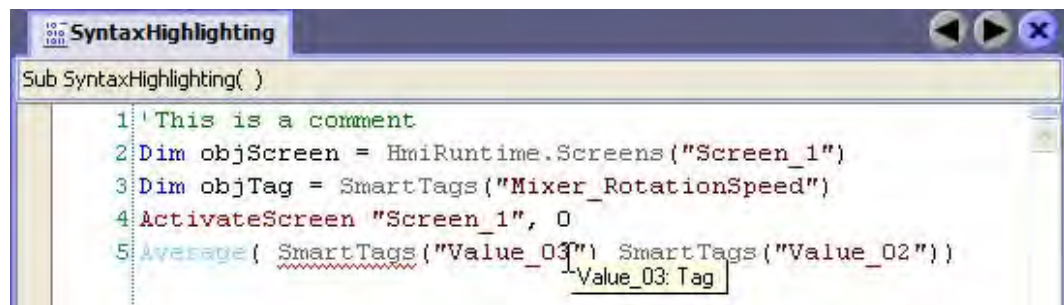

- Script was closed during the renaming

When the script is reopened, the tag is automatically synchronized.

12.4.5 Store script

Principle

A script is stored by storing a project. If you want to use a script on another computer, for example, you can copy the code from the script into a text file or transfer it to another project using copy and paste.

12.5 Debugging

12.5.1 Debugging Scripts

Introduction

Debugging allows you to test your scripts in runtime for logical programming errors. For example, you can test whether the proper values were delivered to the tags, and whether cancellation terms are realized correctly.

To debug your scripts use exclusively the "Microsoft Script Debugger" or the "Microsoft Script Editor" supplied with Microsoft Office XP.

If the script contains VBScript functions, then a distinction must be made between "VBScript for Windows" and "VBScript for Windows CE". Some functions are different, e.g. the `CreateObjectfunction`.

The debugger checks the syntax for VBScript for Windows. If the script contains a function for Windows CE, the system outputs a corresponding alarm.

Error types

The following error types are distinguished when debugging:

- Runtime error

A runtime error occurs when you try to perform an invalid or incorrect instruction, e.g. when a tag is not defined.

In order to intercept runtime errors, you can use the instruction "On Error Resume Next" in the script. With this setting, the script executes the next statement when a runtime error is detected. You can check the error code with the error object in the next line. In order to stop the processing of runtime errors in the script, use the instruction "On Error Goto 0." Additional information about error processing is found in the Microsoft VBS help in the information system.

- Logical error

A logical error occurs when the event you are expecting does not take place, e.g. because a condition was checked incorrectly. In order to resolve logical errors, go through the script step by step in order to identify the part of the script which does not function.

12.5.2 Integrating the debugger

Installing a Script Debugger for WinCC flexible

A script debugger must be installed in order to search for errors in scripts with WinCC flexible.

The following script debuggers have been tested and released:

- Microsoft Script Editor of Office XP (not for Windows Vista OS)
- Microsoft Script Debugger

An installed script debugger is either started automatically when a runtime error occurs in a script or manually with the command "Start runtime system with script debugger".

Microsoft Script Editor

The Microsoft Office XP component "Microsoft Script Editor" contains such a script debugger. If the default settings were used to setup Microsoft Office, the "Microsoft Script Editor" component was set for ("Installed on First Use"). If you wish to explicitly install these components, you must specify it in the Microsoft Office setup. Click on "Web Debugging" in the component selection window and select the option "Run from My Computer".

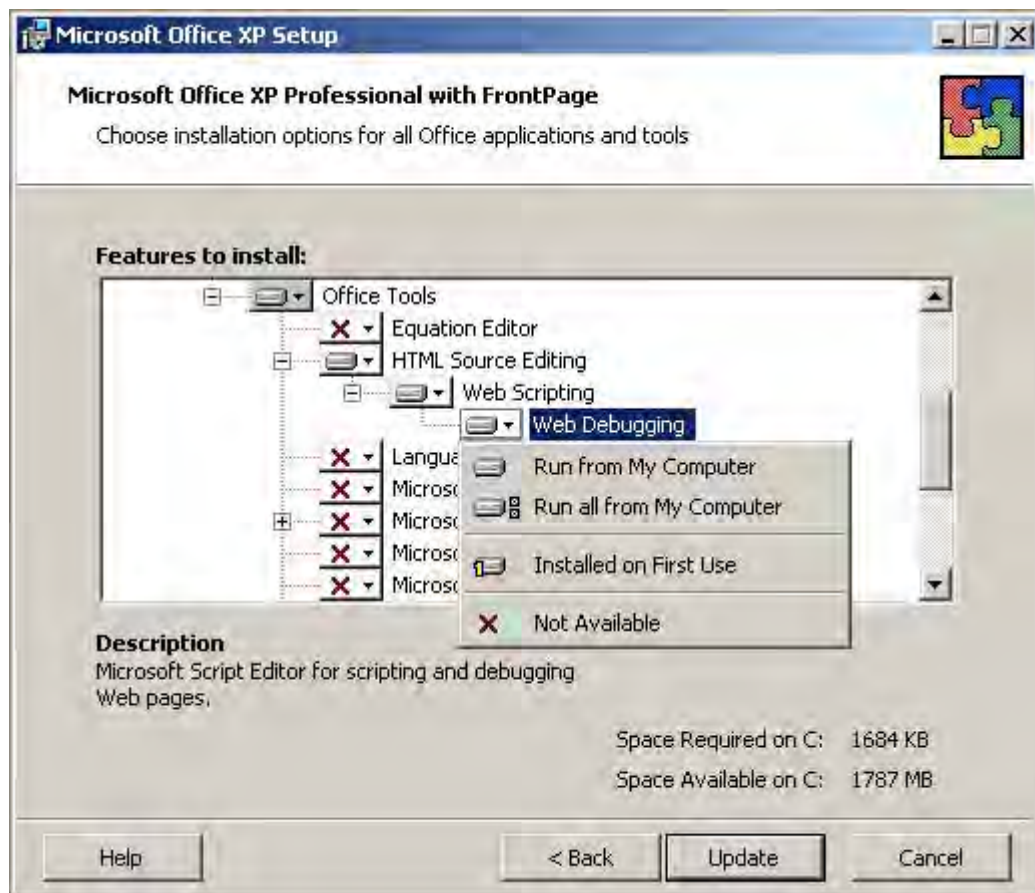

If a project is activated in WinCC flexible with the command "Start runtime system with script debugger", a dialog with a list of available script debuggers appears when the first script is run.

Other installed script debuggers such as "Microsoft Visual Interdev" or "Microsoft Visual Studio .NET" may appear in the list. Select "Microsoft Script Editor" and confirm your selection by clicking "Yes".

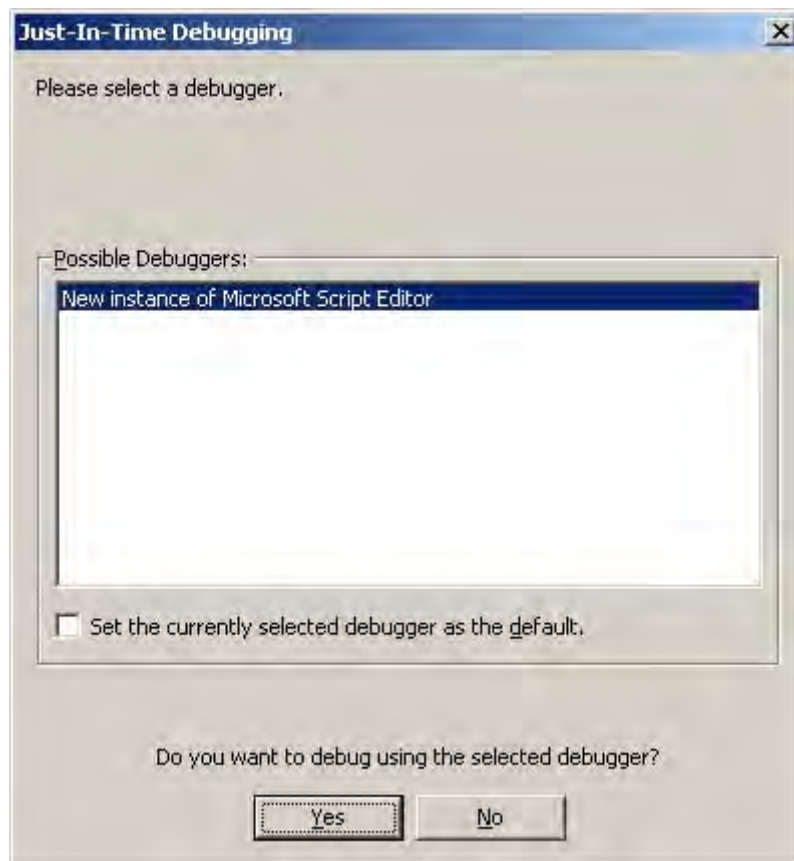

Activate the "Script" program object in the "Step Into Remote Procedure Call" dialog and confirm your selection with "OK".

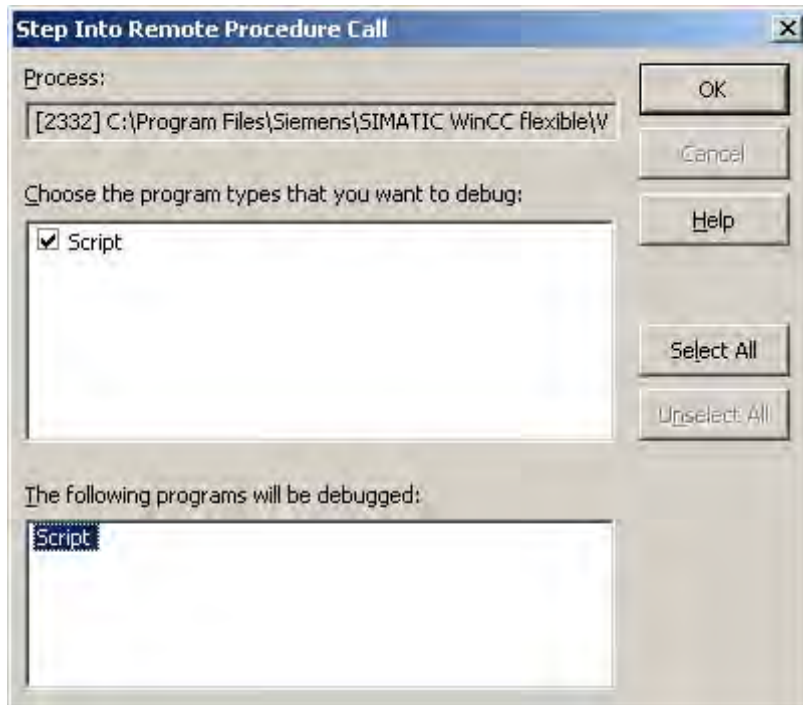

The "Microsoft Script Editor" is launched. The execution pauses at the first row of the first script.

Microsoft Script Debugger

If no script debugger is available, you can download the "Microsoft Script Debugger" (scd10en.exe) for free from Microsoft (www.microsoft.com). It will be started automatically in WinCC flexible once it is installed.

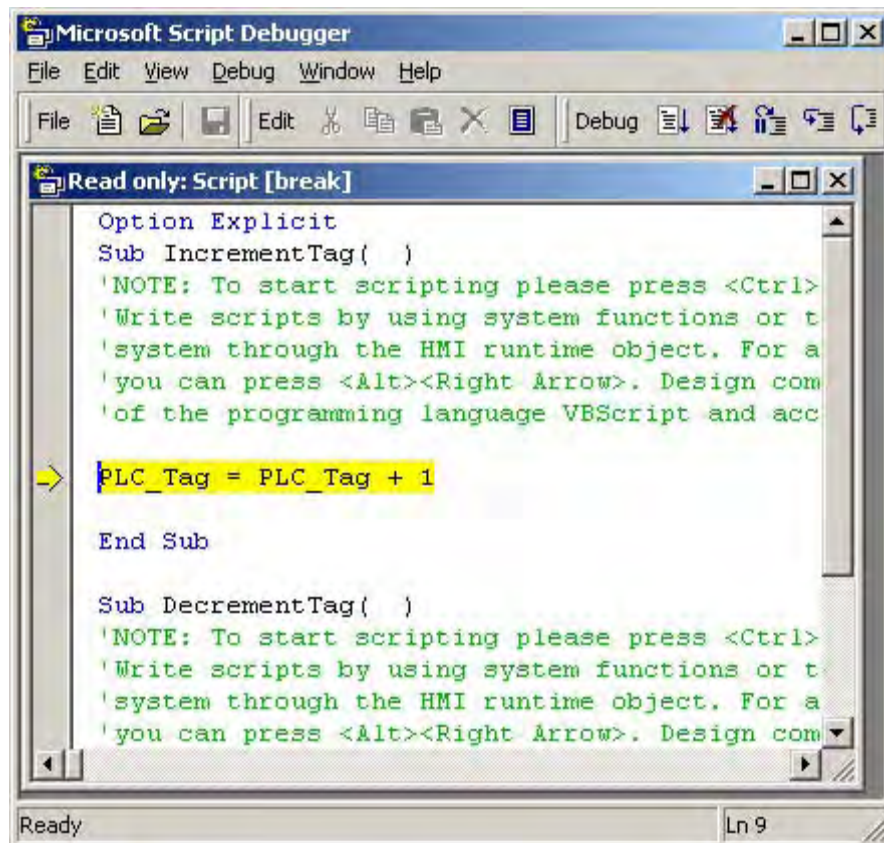

Note

The "Microsoft Script Debugger" is not supported when another script debugger system is available on your computer!

Note

Windows Vista operating system

Log on as administrator and install Microsoft Script Debugger for use in WinCC flexible.

Script Debugger Does Not Start When Runtime Starts

If you have installed a script debugger, and the "Start Runtime with Script Debugger" command does not run it, make the following settings in the Windows registry to set Microsoft Script Debugger as default Just-In-Time (JIT) Debugger:

- "HKEY_CLASSES_ROOT\CLSID\{834128A2-51F4-11D0-8F20-00805F2CD064}]
(Default)="ScriptDebugSvc Class"
"AppID"="{A87F84D0-7A74-11D0-B216-080000185165}"
- [HKEY_CLASSES_ROOT\CLSID\{834128A2-51F4-11D0-8F20-00805F2CD064}\LocalServer32]
(Default)="c:\\Program Files\\Microsoft Script Debugger\\msscrdbg.exe"
- [HKEY_CLASSES_ROOT\CLSID\{834128A2-51F4-11D0-8F20-00805F2CD064}\ProgID]
(Default)="ScriptDebugSvc.ScriptDebugSvc.1"
- [HKEY_CLASSES_ROOT\CLSID\{834128A2-51F4-11D0-8F2000805F2CD064}\VersionIndependentProgID]
(Default)="ScriptDebugSvc.ScriptDebugSvc"

The "LocalServer32" file path must point to the installation folder of Microsoft Script Debugger. You must edit the path name accordingly if Microsoft Script Debugger is installed in a different folder.

12.6 Runtime behavior of functions in runtime

12.6.1 Completion of the function list in runtime

Principle

In runtime a function list is completed from top to bottom. A distinction is made between synchronous completion and asynchronous completion, so that no waiting periods ensue during completion. The distinction is made by the system by evaluating the different runtimes of the system functions. Scripts are always processed synchronously independent of the runtime. If a system function returns an error status, the completion of the function list is cancelled.

Synchronous completion

During synchronous completion, the system functions in a function list are performed one after another. The previous system function must be finished before the next system function can be performed.

Asynchronous completion

System functions, which perform file operations such as storing and reading, have a longer runtime than system functions which, for example, set a tag value.

Therefore, system functions with longer runtimes are performed asynchronously. While a system function writes to a storage medium, e.g. a recipe record, the next system function is already being performed. Due to the parallel completion of system functions, waiting periods at the HMI device are avoided.

12.6.2 Processing of scripts in runtime

Principle

Only one script at a time can be performed in runtime. If several scripts are waiting to be edited, the scripts are lined up in a queue and completed one after another.

Note

A loop in a script therefore blocks the execution of other scripts in the queue even if the scripts are triggered asynchronously.

WinCC flexible supports a maximum nesting depth of eight scripts. Please note that the nesting depth is not checked.

Note

If a script is configured for the "Runtime-Stopp" event, only those functions may be used in the script which are specified as configurable objects in the reference of the "Runtime-Stopp" system function.

Ensure that the ending of the runtime is not interfered with by the execution of the script.

Note

Configuring scripts

During configuration make sure that not too many scripts are activated at the same time. You should also avoid running the system at 100% load for longer periods of time.

Scripts are processed at lower priority so as not to interfere with operation or the representation of values. At high system load the scripts to be executed are initially queued for this reason. The maximum size of the queuing list depends on the device:

- OP 270, TP 270, MP 270, OP 277, TP277 : 50 entries
- MP 277, MP 370, MP 377, PC-Runtime: 200 entries

If more scripts than can be premarked are activated at one time, during a screen change for example, excess calls are discarded and a system alarm displayed.

The scripts include those which are also used in the faceplates. The configured script is reused in all faceplate instances as independent object and causes an entry in the queuing list. Such usage quickly results in maximum capacity of the queuing list.

12.6.3 Delivery and return of values

Transfer of a value

When calling up a script, parameters are delivered according to the principle "Call by value". If you deliver a variable, for example, as a parameter, the value of the variable is delivered to the script on execution of the script.

When scripts and system functions are called, the parameter is delivered according to the principle "Call by Reference".

Example:

You configure a script at the "Click" event for a button. The system function "SetValue(Y, X)" is called in the script. The system function "SetValue(Y, X)" assigns the value "5" to the variable "IndexTag": SetValue IndexTag, 5

If you click on the button in Runtime, the script is executed and the value 5 is assigned to the variable "IndexTag".

Return of a value

Return values can return the result of a calculation (e.g. average value of two numbers). But a return value can also give information about whether an instruction was performed correctly.

Therefore, the system functions which perform file operations such as "Delete" also have return values.

Note

The return value of a system function can only be assigned an external or internal variable.

In order for a script to return a value, you must have chosen the type "Function" for the script. In the script you assign the return value to the name of the script:

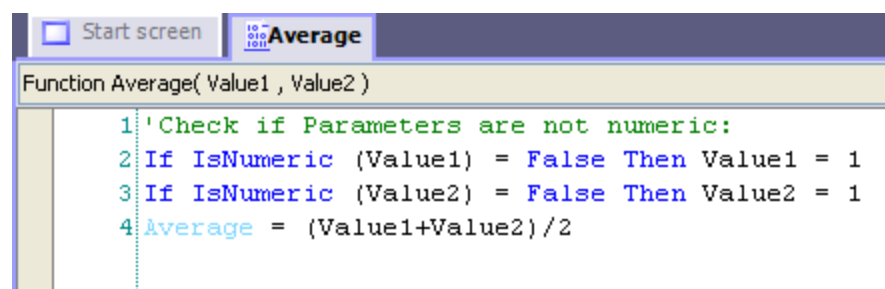

```
Function Average( Value1 , Value2 )
1 'Check if Parameters are not numeric:
2 If IsNumeric (Value1) = False Then Value1 = 1
3 If IsNumeric (Value2) = False Then Value2 = 1
4 Average = (Value1+Value2)/2
```

In order to create an average value from two numbers, call up the Average function and deliver the values to be processed to a variable, for example:

```
AverageValue = Average (4, 6)
```

You can then output the average value in an output field.

12.6.4 Changing of object properties in runtime with VBS

Introduction

You can access object properties of screen objects and tags in runtime with VBS. When you change values of object properties with VBS, this has no effect on the project data.

Changing object properties

When you change an object property of a screen element with VBS in runtime, this change remains effective only as long as the screen is active. As soon as you change the screen or reload the screen, the configured object properties are displayed.

Language switching

When you change the language in runtime, the foreign language labels are loaded from the configuration data. In case you changed text with VBS, this text is then overwritten.

12.6.5 HMI device dependent system functions in the script

Principle

If you use system functions in a script which are not available on the set operating unit, you will receive a warning message. In addition, the respective system function in the script will be underlined with a wavy blue line.

Structure of Multilingual Projects

13.1 Working with multiple languages

Multi-language configuration in WinCC flexible

You can configure your projects in multiple languages using WinCC flexible. There are various reasons for creating a project in multiple languages:

- You would like to use a project in more than one country. The project is created in multiple languages; when the HMI device is commissioned, only the language spoken by the operators at the respective site is transferred to the HMI device.
- You would like to provide multiple languages to the various operators in a plant. The project is created in multiple languages because the service personnel do not speak the same language as the operators. Example: An HMI device is used in China, but the service personnel understand only English.

Translating project texts

With WinCC flexible, you can directly enter project texts in several languages in various editors, for example in the "Screens" editor or the "Project texts" editor. In addition, WinCC flexible provides options for exporting and importing your configuration for translation purposes. This is particularly advantageous if you configure projects containing a large amount of text and want to have it translated.

Language management and translation in WinCC flexible

The following areas of the project view are used to manage languages and translate texts in WinCC flexible.

Area	Short description
Project languages	Management of project languages, editing language, and reference language.
Languages and fonts	Management of runtime languages and fonts used on the HMI device.
Project texts	Central management of configured texts in all project languages.
Graphic browser	Management of graphics and their language-dependent variants.
Dictionaries	Management of system dictionary and user dictionaries

13.2 WinCC flexible terminology

Language principles in WinCC flexible

Multi-language capability is implemented on various language levels in WinCC flexible.

User interface language and project languages

Two language levels are differentiated in WinCC flexible:

- User interface language

During configuration, text is displayed in the WinCC flexible menus and dialog boxes in the user interface language. You select the user interface language to be used when you install WinCC flexible. You can change the user interface language with the menu command "Options ► Settings."

- Project languages

Project languages are used to create a project in multiple languages.

The two language levels are completely independent of one another. For example, you can create English projects at any time using a German user interface and vice versa.

Project languages

The following project languages have been released for WinCC flexible:

- Chinese (PRC)
- Chinese (Taiwan)
- Danish
- German
- English
- Finnish
- Flemish
- French
- Greek
- Italian
- Korean
- Norwegian
- Polish
- Portuguese
- Russian
- Swedish
- Spanish
- Czech

- Turkish
- Hungarian
- Japanese

You can generally also configure in any language available in Windows. However, restrictions may apply when some languages are used for configuration, such as:

- The HMI does not support right-to-left languages such as Hebrew or Arabic.
- Language-specific fonts are not available.
- Non-editable texts stored in WinCC flexible are displayed in English.

The following languages are differentiated within the project languages.

- Reference language

The reference language is the language that you use to configure the project initially.

During configuration, you select one of the project languages as the reference language. You use the reference language as a template for translations. All of the texts for the project are first created in the reference language and then translated. While you are translating the texts, you can have them displayed simultaneously in the reference language.

- Editing language

You create the translations of the texts in the editing language.

Once you have created your project in the reference language, you can translate the texts into the remaining project languages. For this purpose, you select one of the project languages as the editing language and edit the texts for this language. You can change the editing language at any time.

Note

When switching the project languages, the assignment to the keys on the keyboard also changes. In the case of some languages (e.g. Spanish), switching the keyboard assignment is not possible due to the operating system. In this case, the keyboard assignment is switched to English.

- Runtime languages

Runtime languages are those project languages that are transferred to the HMI device. You decide which project languages to transfer to the HMI device depending on your project requirements.

You must provide appropriate operator control elements so that the operator can switch between languages during runtime.

13.3 Language Settings

13.3.1 Language settings in the operating system

Introduction

The operating system settings on the configuration computer influence the language management of WinCC flexible in the following areas:

- Selection of project languages
- Regional format of dates, times, currency, and numbers
- Displaying ASCII characters

Language settings in the operating system

A language is not available as a project language unless it is installed in the operating system.

- Settings in Windows XP:

You can call the "Regional and Language Options" dialog using the control panel icon of the same name in "Start > Settings > Control Panel > Date, Time, Language, and Regional Options." Afterwards, you can install your choice of languages on the "Languages" tab.

The Input Method Editor (IME) is available in Windows for configuring Asian texts. Without this editor, you can display Asian text but not edit it. For more information on the Input Method Editor, refer to the documentation for Windows.

If language-dependent project texts, such as alarm texts, should be displayed in the simulator in Asian characters, the operating system must be switched to the respective language.

Regional format of dates, times, currency, and numbers

WinCC flexible specifies a fixed date and time format in the Date - Time field for the selected project language and runtime language.

In order for dates, times, and numbers to be presented correctly in the selected editing language, this language must be set in the Regional Options on the Control Panel.

Displaying ASCII characters

With text output fields, the display of ASCII characters as of 128 depends on the set language and the operating system being used.

If the same special characters are to be displayed on different computers, then the computers must use the same operating system and country settings.

13.3.2 Operating system settings for Asian languages

Settings on Western operating systems

If you want to enter Asian characters, you must activate the support for this language in the operating system. To do this, open the Control Panel and select "Regional and Language Options". On the "Languages" tab, activate the check box "Install files for East Asian languages". Then click on "Details" under "Text Services and Input Languages". The dialog "Text Services and Input Languages" is opened. On the "Settings" tab add the required default input language under the "Installed Services".

For entering Asian characters on Western operating systems, the "Input Method Editor" must also be installed. To install, under Windows XP in the Control Panel open "Regional and Language Options" ► Languages ► Details." In the "Text Services and Input Languages" add the necessary default input language under "Installed Services".

To enter Asian characters when configuring, switch to the Asian entry method in the "Input Method Editor".

Settings on Asian operating systems

If you are configuring on an Asian operating system, to enter ASCII characters, e.g. for object names, you must switch to the English default input language. As the English default input language is included in the basic installation of the operating system, you do not need to install an additional input locale.

13.3.3 "Project Languages" editor

Introduction

You select the languages for creating your project in the "Project Languages" Editor:

- The project languages for creating your project
- The reference language in which you configure the project initially.
- The editing language in which you translate the text.

Open

To open the "Project Languages" editor, double-click "Project Languages" in the "Localize" group in the "Project view."

13.4 Creating a project in multiple languages

13.4.1 Creating a project in multiple languages

Translation methods

You first create a project for one language only and then test it.

Afterwards, you configure all other languages required. The following options are available:

- Direct translation of project texts in the editors used to create the individual objects.
- Central translation of project texts in the "Project texts" editor.
- Export of project texts, translation in another program, and import of translated texts to WinCC flexible.

Use dictionaries to speed up translation and maintain consistency of translated texts.

Recommended workflow

1. Set a language you are familiar with as the reference language in the "Project languages" editor.

At the start of configuration, the reference language should correspond to the editing language.
2. Create the project in this language. The reference language text is used as the source language for translation.
3. In the "Project languages" editor, set one of the other project languages as the editing language.
4. Translate all project texts into this language. You can perform the translation either directly in the individual editors or in the centralized "Project texts" editor where all project texts and their points of use are displayed.

As an alternative, you can export the texts to a *.csv file, have them translated, and then import the translated texts back into your project.
5. If necessary, adapt the graphics in the project to reflect the editing language or country-specific factors.
6. Repeat steps 3 to 5 for all other project languages.

Result

The project can now be compiled and transferred to the HMI device. Specify which runtime languages are to be available on the HMI device in the transfer settings.

13.4.2 Specific features of Asian and Eastern languages in the engineering system

Introduction

When configuring for Asian languages or in an Asian language some specific features should be observed. These specific features must also be observed for other languages that have complex characters.

Basic principles of configuration

In order to ensure the full functionality of a project, when configuring in WinCC flexible some elements should include no complex characters. The restrictions apply for the following elements:

- Object names
- Alarm texts

The object names in WinCC flexible are unique names and therefore are not translated when switching between languages. As the object names are used and processed functionally, they are subject to some restrictions. The object names may not include any special characters, umlauts or complex characters. Affected object names are, for example, project names, tag names, screen names etc.

If you want to log alarms with alarm texts, then you may not use Asian Runtime language. When using an Asian Runtime language you cannot log alarm text, even if the alarm text itself is written, for example, in English. The restriction applies merely to logging, it is still possible to view and output in Runtime. Russian and other 1 Byte languages are not affected by this restriction.

When using Sm@rtAccess and Sm@rtService only those characters that are known on the HMI device can be used.

User administration

No Asian or other complex characters may be used for user names and passwords.

Project documentation

You can optimize the appearance of the printout by selecting the respective Asian or Eastern font from the Configuration Dialog for the project documentation.

Integration in STEP 7

Asian-language projects integrated in STEP 7 must be started via WinCC flexible. If you start integrated Asian projects via STEP 7, you will receive error messages and display errors.

Displaying regional special characters

Regional special characters included in texts based on the "WinCC flexible" character set may lack clarity when output in Runtime on OP 73micro, TP 177micro, OP 73, OP 77A and TP 177A HMIs. The "WinCC flexible High" character set should be used on these HMIs. If WinCC flexible does not offer this character set, search for the "WinCC flexible High" character set in the "Fonts" folder of the OS installation folder, then double-click the entry.

Project names and object names

Only Asian characters can be used for project names and object names in STEP 7 objects.

13.4.3 Translating project texts in the editor

Introduction

As a general rule, if you are creating a project for multiple languages, all texts are configured initially in a language you are familiar with. You use this language as the reference language for translation.

Define the project languages in the "Project languages" editor. Select the reference language and the respective editing language to which it should be translated, from the project languages.

Editors with language-dependent objects

The following editors contain language-dependent objects:

- Screens
- Protocols
- Analog alarms
- Discrete alarms
- System alarms
- Recipes
- Text lists
- Graphics lists

Switching the editing language in the WinCC flexible editors

You can switch the editing language by means of the "Localize" toolbar. The editing language applies to all editors.

Reference texts

As a general rule, if you are creating a project for multiple languages, all texts are configured initially in a language known to you. This language then serves as the reference language.

If you then switch the editing language to enter texts in another language, all of the text fields are empty.

WinCC flexible offers a convenient reference text function so that you have a template for translation. You can display the reference text window containing texts in the reference language in dialogs and editors.

Elements in the "Project texts" editor

In the "Project texts" editor, a single column is created for each project language you have set. The text of a configured object is represented in all languages in a single row in the table. The rows are divided into the following columns.

- Reference language column

The first column displays the texts in the reference language.

- Reference column

The "Referenced by" column indicates the editor where the texts originated.

- Project languages

The remaining columns display the texts in the other project languages provided the texts have already been translated.

Translation methods

You can translate the configured texts as follows:

- Internal translation of texts directly in the "Project texts" editor.

This method is recommended for texts with little to be translated.

- External translation of texts using the export and import function.

This method is recommended for large amounts of text to be translated or when there are many project languages.

The "Project texts" editor is linked to the other editors. Texts introduced here are automatically available in other editors as appropriate. You can also jump directly from the "Project texts" editor to the point of use of the object to be translated.

13.4.5 Exchanging texts with translators

Introduction

External translation of project texts is advantageous when there is a large amount of text in multiple languages. You can use the export function to transfer project texts to external translators. You can then use the import function to reintegrate the translated texts back into your project.

Scope of export and import

- Export and import of all project texts

If you want to send all texts for translation (in the case of a new project, for example), you export all texts from the project to a *.csv file for the translator. You then import the texts following translation. The translated texts are automatically assigned to the correct point of use in the project.

If you have made changes to project texts in WinCC flexible in the meantime, the modified texts are not overwritten during the import.

- Export and import of texts in a particular editor

You can limit the export and import of texts to those in a particular editor in WinCC flexible.

- Export and import of new texts for partially translated projects

If you have inserted new texts in a previously translated project, you can selectively export the texts that have not yet been translated. This minimizes the translation effort required.

Requirement

The "Project texts" editor is open.

Procedure

1. Click on the column header of the target language.
The entries are sorted alphabetically. Empty cells are displayed at the start of the column.
2. Select the empty cells.
By pressing the shift key you can select several cells at once.
3. Select the "Texts" > "Export" command on the "Options" menu.
4. Enter a name and a path for the *.csv file where the texts are to be exported.
5. Select the source language.
6. Select the target language.
7. Activate the "Enter text instances in the export file" check box.
8. Click "OK" to confirm your entries.

Result

All the texts of the selected columns will be exported both in the source and in the target language.

Note

You have the option to export the texts to an XLS file if an MS Office package is installed on your PC.

13.5 Working with dictionaries

13.5.1 Working with dictionaries

System dictionary and user dictionary

Various dictionaries assist you when translating projects in WinCC flexible.

- System dictionary

The system dictionary included in WinCC flexible contains commonly used process automation terminology and the corresponding translations. The system dictionary can be viewed but not modified.

All rights for the source documents lie with the "Landesinstitut für Erziehung und Unterricht (LEU)", Rotebühlstraße 131, 70197 Stuttgart, Germany,
Tel. +49 711 6642-235, Fax +49 711 6642-203

["http://www.schule-bw.de/unterricht/faecher/englisch/berufsschule/techn_woerterb"](http://www.schule-bw.de/unterricht/faecher/englisch/berufsschule/techn_woerterb)

In as far as nothing is specified to the contrary and in as far as rights of other parties are not affected, the distribution of these documents as a whole or in part, in electronic and printed form, is desired under the condition that the source (Landesbildungs-Server Baden-Württemberg) and the URL are named.

A commercial distribution of the documents is expressly prohibited without the previous written permission of the LEU.

- User dictionaries

You store translations of terms that occur repeatedly in your project texts in a user dictionary. In a user dictionary you can directly enter terms or adopt project texts from the editors.

WinCC flexible enables the use of several user dictionaries. These are physically managed within a file and can be integrated in new projects.

Auto translate function

When the "Auto translate" function in the "Project texts" editor is enabled, all dictionaries are searched for the terms to be translated. Terms that are found are entered as suggested translations in the "Project texts" editor. You can then accept or modify the suggested translations. Automatic translation fails if the text to be translated contains tags or text lists.

Uninstalling user dictionaries

The uninstall routine also deletes the user dictionaries. You should create a backup copy of the dictionaries to save these for further use.

1. Search for the "UserDictionary.dct" file in the "C:\Documents and Settings\All Users\Application Data\Siemens AG\WinCC flexible" folder.
2. Copy the "UserDictionary.dct" and "UserDictionary_log.LDF" files.

Note

The following storage location is used in Windows Vista:

"C: \ProgramData\Siemens AG\WinCC flexible"

13.5.3 "User dictionary" editor

Introduction

You can view and edit the terms of a user dictionary in the "User dictionary" editor.

Opening the "User dictionary" editor

User dictionaries are displayed in the "Localize > Dictionaries > User dictionaries" group in the project view. To open the "User dictionary" editor, double-click the name of a user dictionary.

Note

Only one instance has write access if several instances of WinCC flexible are open; all others have read access only.

Structure of the "User dictionary" editor

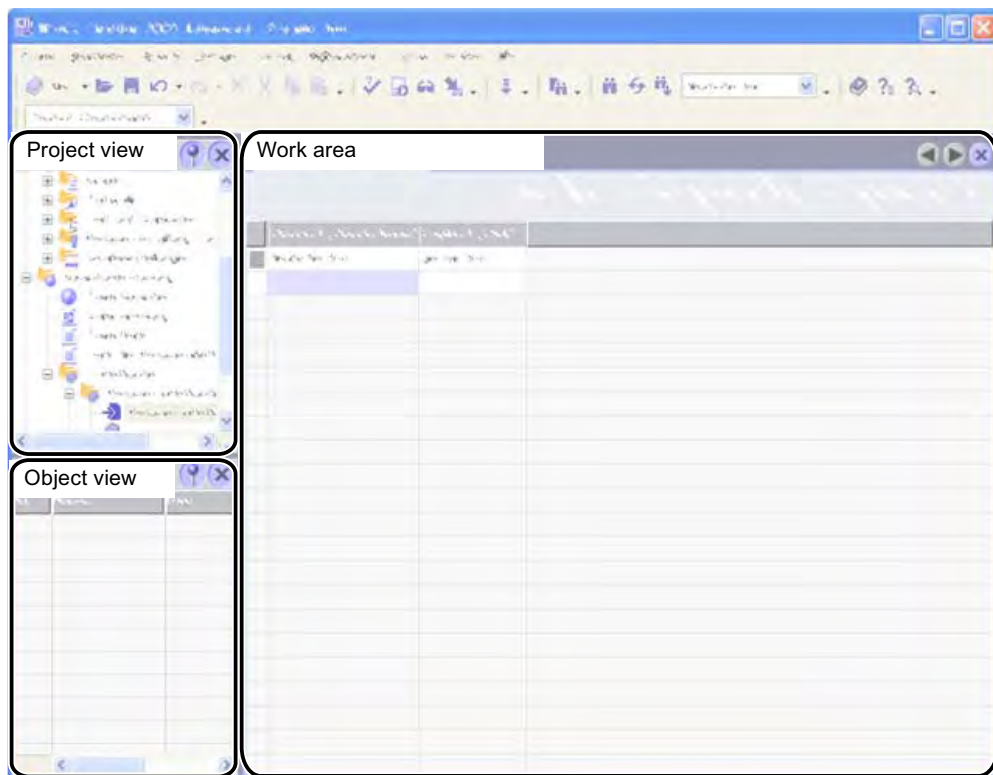

Work area

The text of the user dictionary is shown in tabular form in the work area. When creating a user dictionary, you select the languages the user dictionary should include. The table in the editor contains one column for each of these languages. Each table row contains a term in the reference language and its translations provided you have entered these translations in the user dictionary.

13.6 Use of language-dependent graphics

13.6.1 Use of language-dependent graphics

Language-dependent screen versions

You use the "Graphics" editor to import graphics into your project and manage their language-dependent versions. The graphics can then be linked to the process screens of the project in the "Screens" editor. If you create a project in multiple languages, different graphics may be required for the various project languages due to the following:

- The graphics contain text.
- Cultural factors play a role in the graphics.

In both cases, you must produce language-dependent versions of the graphics.

Basic procedure

1. First, configure all process screens for one language in the "Screens" editor.
2. Create a version of the graphics for each project language in a graphics program.
3. In the "Graphics" editor, import the language-dependent graphics into the project.

Result

The version of each graphic for the current editing language setting is displayed in the "Screens" editor. The version of each graphic for the current runtime language setting is displayed during runtime.

13.6.2 "Graphics" editor

Introduction

You manage the configured graphic objects in multiple language versions in the "Graphics" editor.

Opening the "Graphics" editor

To open the "Graphics" editor, double-click the "Graphics" editor entry in the "Localize" group in the project view.

Structure of the "Graphics" editor

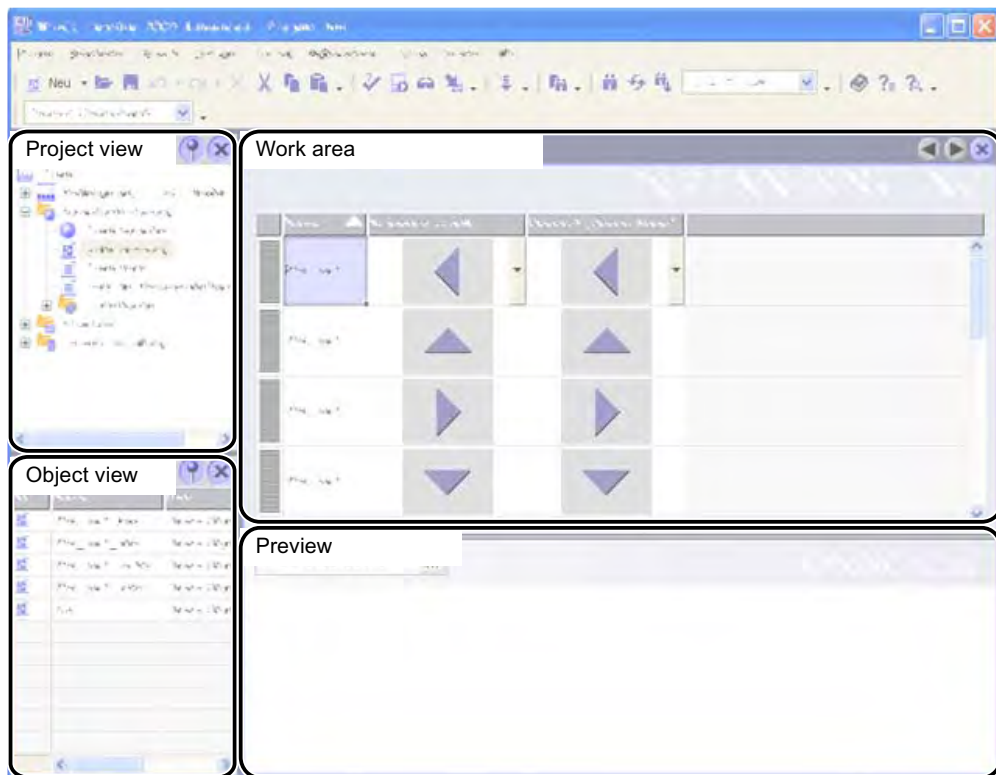

Work area

Here all of the configured graphic objects are displayed in a table. A separate table column is created for each project language, which contains the versions of the graphics for that language.

In addition, you can specify a default graphic for each graphic to be displayed whenever a language-specific graphic for a project language does not exist.

Preview

Here you can preview the graphic displays on various HMI devices.

13.7 Languages in Runtime

13.7.1 Languages in Runtime

Using multiple runtime languages

You can decide which project languages are to be used as runtime languages on a particular HMI device. The number of languages that can be available simultaneously on the HMI device is dependent on the device. To enable the operator to switch between languages during runtime, you must configure a corresponding operator control element.

When runtime starts, the project is displayed according to the most recent language setting. When runtime starts the first time, the language with the lowest number in the "Order for language setting" is displayed.

Setting runtime languages during configuration

In the "Languages and Fonts" editor you can specify:

- The project languages to be available as runtime languages for the respective HMI device.
- The order in which the languages are to be switched.

Text field length for Asian languages

Make allowances for an appropriate length of the text fields when working on multilingual projects with Asian languages. Field contents may be partially hidden, depending on the font and the font size.

1. Open "Properties > Display mode" in the Properties window.
2. Disable the "Align automatically" check box.
3. Verify the proper display in runtime.

13.7.2 Configuring language switching

Introduction

If multiple Runtime languages are available on the HMI device, you must configure language switching. This is necessary to enable the operator to switch between the various Runtime languages.

Methods for language switching

You can configure the following methods for language switching:

- Direct language selection

Each language is set by means of a separate button. In this case, you create a button for each Runtime language.

- Language switching

The operator toggles the languages by means of a single button.

Regardless of the method used, the button names must be translated into each of the languages used. You can also configure an output field that displays the current language setting.

13.7.3 Specific features of Asian and Eastern languages in Runtime

Introduction

When configuring for Asian languages some specific features should be observed for operation in Runtime.

Memory requirement for Asian character sets

The memory requirement is of course greater when using Asian languages. Therefore, watch out for any error messages when compiling.

Inputting Eastern and Asian characters (not ANSI)

The input of Eastern and Asian characters is not possible on PC-based HMI devices.

Interpretation of Asian characters

When using Sm@rtAccess and Sm@rtService only those characters that are known on the HMI device can be used. To be able to use Asian characters, these must be configured in the engineering system. Additionally configured characters require additional memory on the HMI device. Please observe the size of the available memory on the HMI device.

Configurable character sets

With the 270 series HMI devices and with MP 370, alongside the default European and Asian character sets, only configurable European character sets can be used. Additional, configurable character sets for Asian languages cannot be used at present.

Font size for Asian character sets

Use at least a font size of 10 points to display the text of projects created for Asian languages in Runtime. Asian characters will become illegible if smaller font sizes are used. This rule is also valid for the default font used in the "languages and fonts" editor.

Project documentation

14.1 Basics

14.1.1 Project documentation

Introduction

Project documentation serves to print the configuration data of a WinCC flexible project, e.g. a table containing the tags used and their parameters.

Application

You can output configuration data in a project report. You can output a project report for:

- A complete WinCC flexible project
- A component of WinCC flexible
- A single or multiple objects

The selection of the output data depends on the objects or components selected. The composition of the data depends on the selected "Compact" or "Complete" output format and is carried out when the project report is generated by the system.

A separate chapter is output for each component if you output the configuration data of several or all components of WinCC flexible. A separate chapter is also output for each WinCC flexible screen in view of the possible data quantity.

You can open the project report in a preview before you start the output. The preview allows you to check the project report.

Output media

Project reports can optionally be output to:

- A printer
- A file
- The screen

Note

All screens used in WinCC flexible are saved to a separate folder when a project report is generated and if the following requirements are met:

- You used the project preview and exited it with "Exit".
- You print the project report to a file.

The screens are saved to files with "*.emf" extension.

14.1.2 Structure of a layout

Introduction

A layout for the project documentation consists of a cover sheet and a formal contents sheet which is filled dynamically with the configuration data. If the data for the output fill several pages, page breaks are inserted automatically by the system. Layouts are divided into various areas. The page area displays the entire layout surface. The print margins can be specified for this area. The printable area consists of the header, footer and the page body.

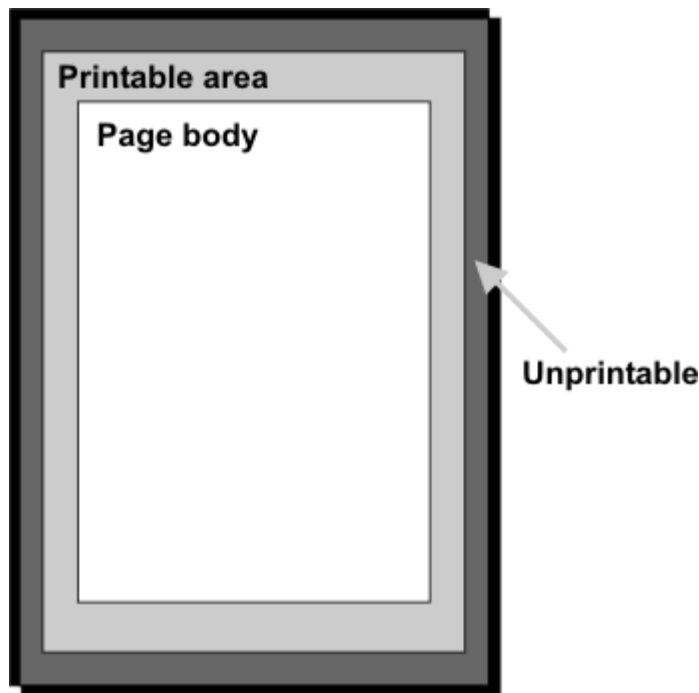

The header and footers are output on every page of a project report. The header and footer are not output on the cover sheet.

Layout of the cover sheet

General information about the project can be output on the cover sheet. The cover sheet contains predefined fields in which you can enter the corresponding information by means of a dialog box. The following information can be output on the cover sheet:

- Project name
- Company name
- Department name
- Author name
- Company logo
- Project logo

Layout of the contents pages

The configuration data are output on the contents pages. The following elements are output in a project report:

Line	Contents
Title	Designation of the selected components for the project report
Label	Designation of the objects, the attributes and the output WinCC flexible screens.
Array	Output configured attribute values of objects.

The lines listed in the table are repeated for all the objects contained in the project report. Two formats are available for the output.

In "Compact" format the data are output in a five-column table. In "Compact" format the five most important attributes of an object are output. The five attributes to be output are preset in the system. The selection of these attributes cannot be modified.

In "Complete" format the data are output in two columns. In "Complete" format all the attributes of an object are output in the report.

The output format is selected in the "Print project documentation" dialog box. Select the "Compact" or "Complete" format on the "Contents" tab in the "Documentation of the properties" area.

14.2 Using layouts

14.2.1 Using layouts

Introduction

The "Print project documentation" dialog box is used to edit the layouts. This dialog box is used to create new layouts and to duplicate and/or delete existing layouts.

Overview







WinCC flexible provides a ready-made layout as the basis for a project report. The ready-made layout with its settings is always used if you use the  command button to create a new layout. WinCC flexible generates the "standard layout" from the ready-made layout. The layout is used for the output of project reports using the "Print Selection" function.

The layouts for the project reports are stored centrally in WinCC flexible and are therefore available in all projects for all users. Configure the common properties of a layout for a WinCC flexible project, e.g. author, company name, project name, header, footer, display used and the settings for the output. Duplicate this template several times and specify different configuration data for the output in each of these templates. For example, create a separate project report for each WinCC flexible component.

A predefined style is available in order to lay out a project report. The style can be modified as required. The style is not saved with the individual layouts. A change in the style therefore affects all the existing layouts.

Commands for layout editing

The following commands are available in the "Print project documentation" dialog box to edit the layouts.

Button	Pop-up menu command	Hotkeys
	New	<CTRL+SHIFT+N>
	Duplicating	<CTRL+SHIFT+D>
	Deleting	
	Rename	F2
	Print	<CTRL+SHIFT+P>
	Preview	<CTRL+SHIFT+V>
	Export	<CTRL+SHIFT+E>

14.2.2 Editing a layout for the project documentation

Introduction

A layout is opened by using the "Print project documentation" dialog box. The "Print project documentation" dialog box is accessed via:

- The "Project ► Print project documentation..." menu command
- The  command button in the "Print" toolbar.

Open the properties of the layout to be edited by using the mouse to select the layout.

Editing possibilities

The properties of the selected layout are displayed in the "Print project documentation" dialog box.

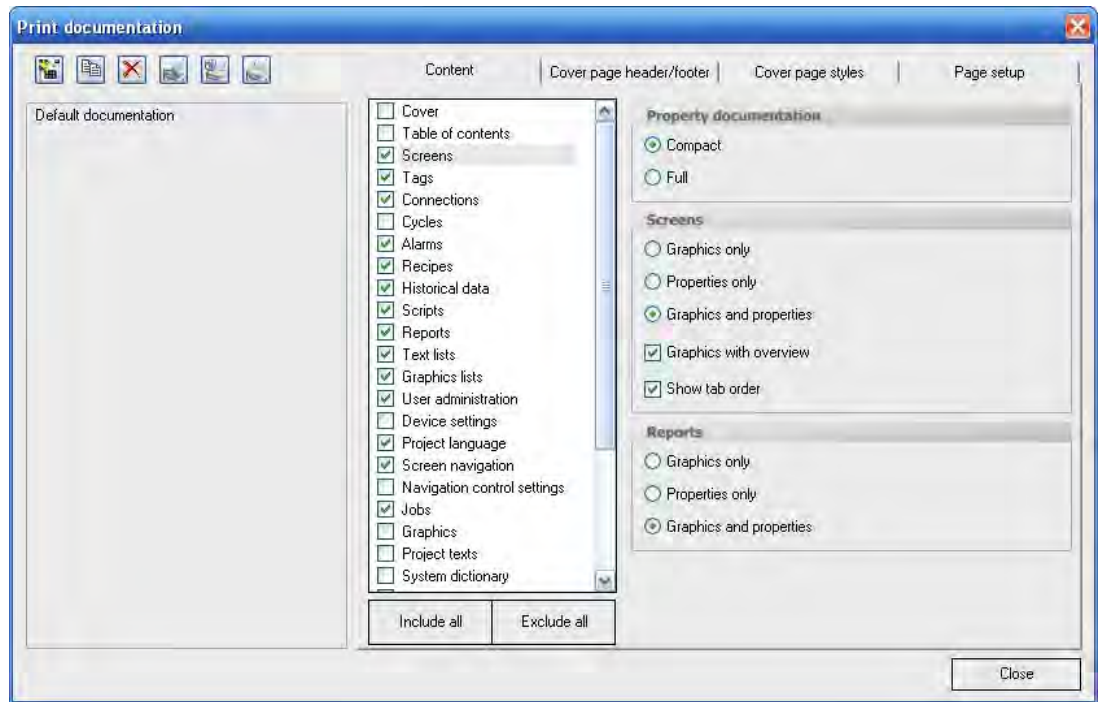

The following table shows the available categories and the editing possibilities.

Tab	Editing possibilities
"Contents"	Is used to select the data for the output.
"Cover sheet"	Is used to enter the contents for the cover sheet, header and footer.
"Style of cover page "	Is used to configure the style.
"Page setup"	Is used to configure the paper format, the page orientation, the page margins and the height of the header and footer.

14.3 Creating a project report

14.3.1 Selecting the data for a project report

Introduction

The selection of the data depends on the selected output format in the layout used. Five attributes each specified by the system are output in the project report for each object in the "Compact" output format. All the attributes of the configured objects of a WinCC flexible component are output in the "Compact" or "Complete" output format.

Overview

Select the WinCC flexible components for the output on the "Contents" tab in the "Print project documentation" dialog box. Select the output format "Compact" or "Complete" in the "Documentation of the properties" area. In the WinCC flexible components "Screens" and "Reports" you can limit the output of the data. The following options are available:

- "Only graphics"
- "Only properties"
- "Graphics and properties"

Further selection options in the "Screens" area":

- "Graphics with overview", outputs the screens with the permanent window.
- "Show tab order" outputs the screens with the tab order.

14.3.2 Outputting of data of selected objects

Introduction

WinCC flexible offers you the possibility to output the configuration data of individual objects. The output can also be carried out for several selected objects.

Overview

Select the objects for the data output in the project view or in the object view.

The output of the configuration data of a selected object is always performed with the "standard layout". The desired output options have to be set in this layout. Selection of another layout is valid for the documentation of individual object data.

The configuration data of the selected objects are opened in the preview. Outputting to a printer can be started from the preview. The  button can be used to copy the data to the clipboard for further use.

14.3.3 Selecting Objects for the Project Documentation

Introduction

WinCC flexible offers various options for outputting the configuration data of individual or multiple objects of a WinCC flexible component. Start the output using the:

- Main menu
- The toolbar
- The shortcut menu of selected objects

Selecting the objects

Activate the object view and select the desired WinCC flexible component in the project view using the menu command "View ► Objects". The existing objects of the WinCC flexible component are displayed in the object view. Use the mouse to select one or more objects whose data you want to output in the object view.

You can also open the node of a WinCC flexible component in the project view. The existing objects of the WinCC flexible component are displayed. Select one or more objects using the mouse.

Outputting the data

WinCC flexible provides several options for the output of data. After the object selection you start the output via:

- The  button.
- The "Print selection" command in the shortcut menu of the selection.
- The "Project ► Print Selection" command in the menu bar

The configuration data are inserted into the "standard layout" and opened in the preview window.

Mobile Wireless

15.1 Basic principles

15.1.1 Field of application for the Mobile Panel Wireless

WLAN in automation

The trend towards mobile communications in current and future information technology has led to the use of innovative wireless networks in automation engineering. Wireless HMI systems via WLAN provide a user-friendly and flexible way to control and monitor practically any location on the machine or in the plant in real-time.

- This has significant cost and time benefits in terms of commissioning and maintenance
- It also greatly increases efficiency during troubleshooting and fault elimination
- Maximum flexibility for mobile operator control and monitoring

Industrial applications

Wireless networks are currently used for the following industrial application:

- Production and process automation
- Automotive
- Machine and plant construction
- Food, beverages and tobacco
- Warehousing and logistics
- Conveyor systems

Features

The Mobile Panels Wireless differ very little from the hard-wired Mobile Panels. The access points to the Mobile Panel are different in many applications, however. This customer requirement is now met optimally by the Mobile Panels Wireless.

Application Examples

With the Mobile Panel Wireless, you can move through the plant without restriction, with or without safety engineering. You can control and monitor moving machine parts or the entire plant in relation to the situation. This is now possible as the Mobile Panel Wireless provides the necessary detailed view. Plant structures are becoming every more complex, but you can now create a large display with additional buttons. A large display with its generously-sized buttons provides reliable and easy touch control - even when wearing gloves.

Solutions

With the integrated solutions from Siemens, you can plan, configure, simulate and extend wireless networks quickly and reliably. The Mobile Panels Wireless build upon the standardized WLAN technology and are specially tailored for the requirements of automation:

- Unrestricted mobility and flexibility
- Innovative and future-proof network architecture
- Reliable and deterministic wireless transmission in real-time
- Maximum reliability and security during wireless transmission
- Sufficient bandwidth and monitoring of the signal strength
- Functions are compatible with the stationary HMI devices and hard-wired Mobile Panels
- Can be fully integrated into existing systems
- Information protected by access control, authentication and encryption
- Fail-safe due to safety functions and communication via PROFI-safe
- Rugged construction for harsh industrial conditions

15.1.2 How the Mobile Panel Wireless works

Overview

Certain spatial parts of the plant are of particular importance for operator control and monitoring via a wireless network: the zones and the effective ranges. A zone or an effective range is determined by the following:

- A certain part of a plant or machine.
- The overall planning of the wireless network.
- The configuration and parameter settings for the component involved.
- The distribution of transponders around the plant.

To give a basic understanding of all this, the following section described the interaction between:

- HMI device
- Zone
- Effective range
- Transponder

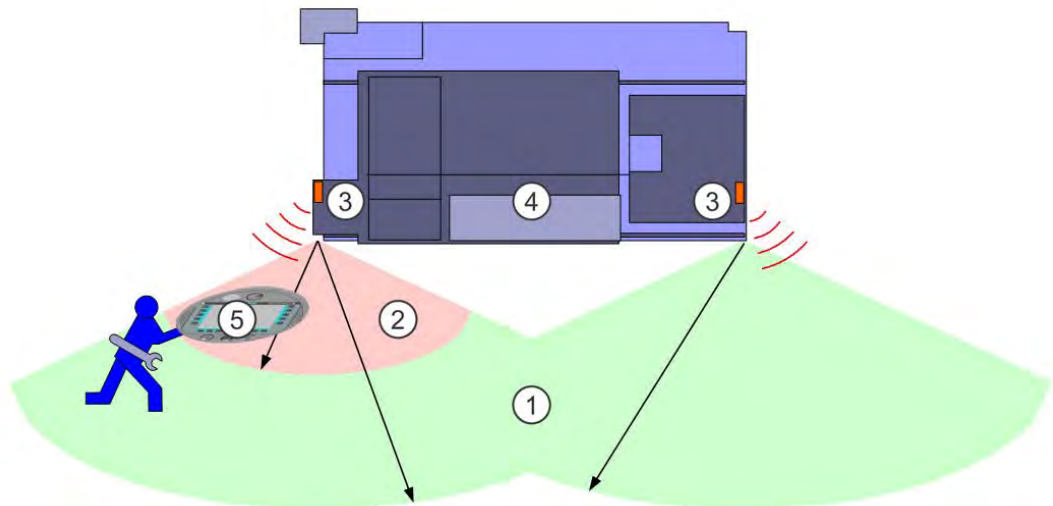

WLAN area

A WLAN area is the area of wireless coverage of the network with a sufficient signal strength to allow the HMI device to communicate with the PLC. A Mobile Panel Wireless is used for operator control and monitoring of the plant in a WLAN area.

Zone

A zone (1) is a spatial area immediately upstream of a machine or plant (4) registered by the Mobile Panel (5). This allows the HMI device to respond specifically when the zone is entered. For example, you can set it up so that the screen changes to the correct process display.

In a hard-wired Mobile Panel, the length of the connecting cable defines a zone around a connection box. With a Mobile Panel Wireless, the distance from one or more transponders (3) on the machine defines a zone within the WLAN area.

Effective range

Safety-related operator input is only possible in a limited part of a WLAN area upstream of a machine or plant (4). This is known as the effective range (2). One exception to this rule is the emergency stop, which works in the entire WLAN area. For all other safety-related operator input, the following requirements must be fulfilled:

- The HMI device (5) supports fail-safe operation, e.g. Mobile Panel 277F IWLAN.
- The HMI device is incorporated into the PROFIsafe communication.
- The HMI device must be logged into the effective range.

The HMI device can only log in within the effective range. This also requires there to be no other HMI device logged into the same effective range.

The concept of the effective range ensures the necessary spatial assignment of the Mobile Panel to the machine, reliably and with no wireless obstacles. This increases the reliability, fail safety and access control to create a holistic safety concept within the effective range.

NOTICE

More information in this regard is available in the "Failsafe operation" function manual. You should always assign administrator rights or set up encryption to protect the project containing a Mobile Panel Wireless for fail-safe operation against unauthorized access.

Transponders form zones and effective ranges

Zones (1) and effective ranges (2) are formed by the spatial assignment of transponders (3) to the machine (4) or plant.

NOTICE

To ensure that the login and machine operator input are clear, one effective range must not overlap another effective range and a zone must not overlap another zone. This requires each transponder to have just one effective range and one zone assigned to it.
--

Effective ranges and zones have totally different functions:

- | |
|---|
| <ul style="list-style-type: none">• You configure effective ranges and zones separately from one another.• Effective ranges and zones can overlap. |
|---|

A specific area, effective range or zone is defined by the maximum distance from one or more transponders. Transponders send their ID in a conical pattern while the HMI device measures its distance from the transponder.

The configured zones and effective ranges are stored on the HMI device. The HMI device is exactly within an area if the following conditions are fulfilled for at least one transponder in the area:

- The HMI device is within the radio cone of the transponder so that it receives the transponder ID.
- The HMI device measures a distance from the transponder that is less than the configured distance of the area.

Example:

- A uniform distance of 8 m from both Transponder1 and Transponder2 is configured for the "MixingPlant" zone. This, together with the opening angle of the radio cone, defines the outer limit of the zone for a screen change.
- A screen change to the "MixingPlant_1" screen is configured on entering the "MixingPlant" zone.
- A uniform distance of 5 m from Transponder1 is configured for the "MixingAxisControl" effective range. This, together with the opening angle, defines the outer limit of the effective range in which safety-related operator input is possible.

The HMI device measures the following distances:

- A distance of 7 m from Transponder1.
- A distance of 8 m from Transponder2.

Result:

- The HMI device is within the "MixingPlant" zone. The "MixingPlant_1" screen is displayed.
- The HMI device is outside the "MixingAxisControl" effective range. Apart from an emergency stop, no safety-related operator input is possible via the HMI device.

15.2 Elements and basic settings

15.2.1 Zones

Introduction

The following section applies only to the Mobile Panels Wireless, e.g. Mobile Panel 277 IWLAN and Mobile Panel 277F IWLAN. The "Zones" working area is only visible for these HMI devices.

You will have to set up the zones in order to carry out system-specific operator control and monitoring tasks. A zone is defined by the maximum distance from one or more transponders.

Open

Double-click on "Zones" under "Device settings" to open the working area in the project view.

Structure

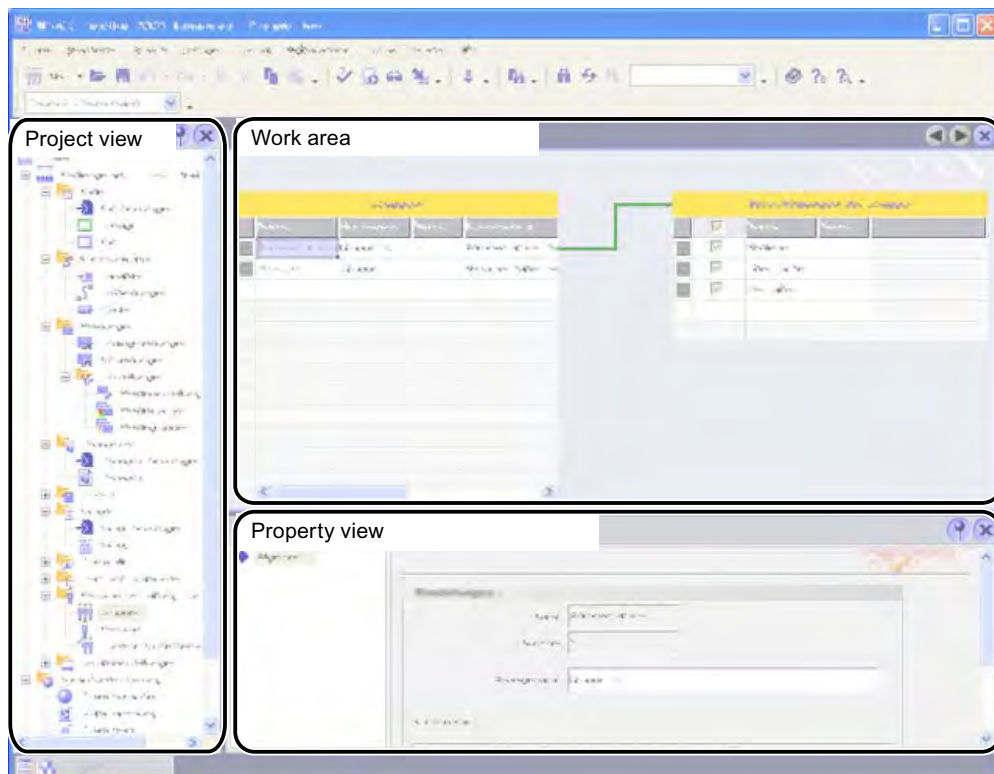

Working area

The "Zones" working area displays the zones that have been set up and the transponders assigned to them.

Property view

When a zone is selected, you can edit the names, display names and the limits of the zone under the "General" category. The zone has the "On entry" and "On exit" zones. Assign the "ActivateScreen" system function to the events.

You can only assign a transponder to one zone so that the zones do not overlap.

15.2.2 Zones working area

Introduction

The "Zones" working area displays the zones and the transponders assigned to them in table format. You create a list of transponders and assign certain transponders to a zone. The limit of the zone is defined by the maximum distance from the transponders.

Principle

The working area consists of the "Zones" and "Transponders" tables.

The screenshot shows a software interface titled 'ZONES'. It contains two tables. The 'Zones' table has columns: Name, Display name, ID, Limits, and Comment. It lists 'MixingPlant' (ID 1, 8 m) and 'FillingPlant' (ID 2, 7 m). The 'Transponder' table has columns: Name, ID, Zone, and Effective range. It lists four transponders: 'Transponder_1' (ID 1, assigned to MixingPlant, range MixingAxisControl), 'Transponder_2' (ID 2, assigned to MixingPlant), 'Transponder_3' (ID 3, assigned to FillingPlant), and 'Transponder_4' (ID 4, range FillingAxisControl). A green arrow points from the 'Zones' table to the 'Transponder' table.

Zones				
Name	Display name	ID	Limits	Comment
MixingPlant	MixingPlant	1	8 m	
FillingPlant	FillingPlant	2	7 m	

Transponder			
Name	ID	Zone	Effective range
<input checked="" type="checkbox"/> Transponder_1	1	MixingPlant	MixingAxisControl
<input checked="" type="checkbox"/> Transponder_2	2	MixingPlant	
<input checked="" type="checkbox"/> Transponder_3	3	FillingPlant	
<input type="checkbox"/> Transponder_4	4		FillingAxisControl

If you select a zone in the "Zones" table, the "Transponder" table displays the following:

- Transponder enabled: The transponder is assigned to the selected zone.
- Transponder deactivated: The transponder is not yet assigned to any zone.
- Transponder not available: The transponder has already been assigned to another zone. To undo the assignment, switch to the relevant zone and deactivate the transponder.

The zone and transponder IDs are initially assigned automatically. They can be changed, however.

Please note the following:

- A maximum of 254 zones may be configured.
- The zone ID must be unique and fall within the range from 1 - 254.
- You can initially configure transponders without assigning them to a zone.
- There may be no more than 255 transponders assigned to a zone, an effective range or both.
- The transponder ID must be unique and fall within the range from 1 - 65534.

The transponder IDs are set on the transponder.

15.2.3 Effective ranges

Introduction

The following section applies only to the Mobile Panels Wireless that support failsafe operation, e.g. Mobile Panel 277F IWLAN. The "Effective ranges" working area is only visible for these HMI devices.

You set up effective ranges in order to control safety related operations. An effective range is defined by the maximum distance from one or more transponders.

NOTICE
More information in this regard is available in the "Failsafe operation" function manual.

Open

Double-click on "Effective ranges" under "Device settings" to open the working area in the project view.

Structure

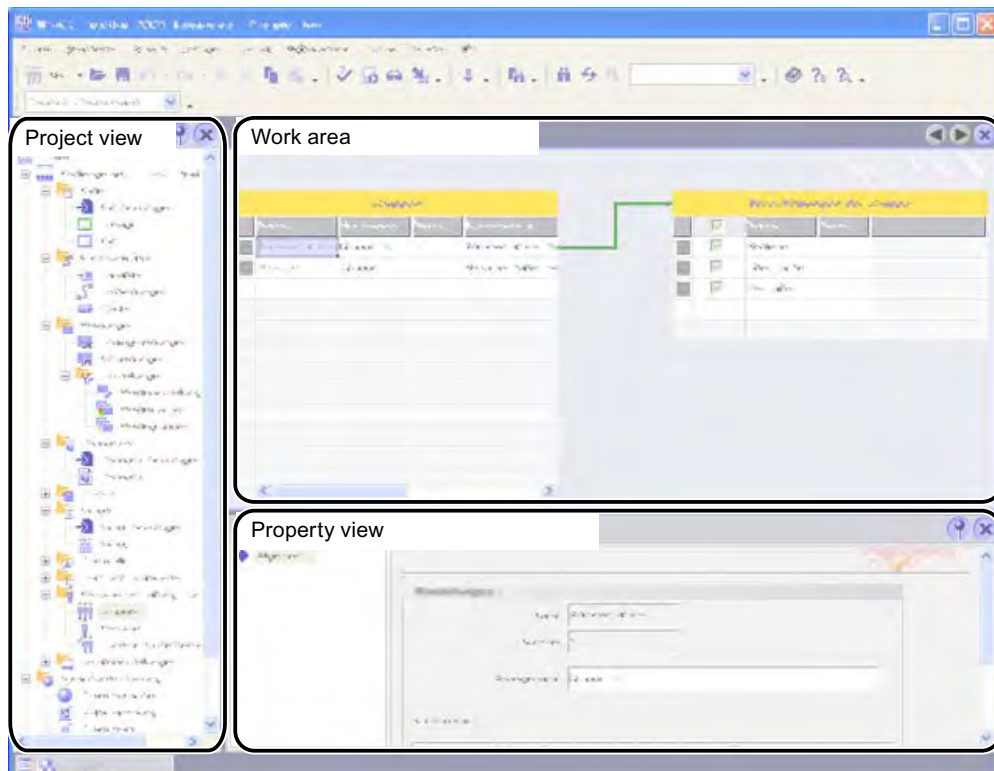

Working area

The "Effective ranges" working area displays the effective ranges that have been set up and the transponders assigned to them.

Property view

When an effective range is selected, you can edit the names, display names and the limits of the effective range under the "General" category.

When you select a transponder, you can see both the effective range and the zone that are assigned to that transponder. You can only assign a transponder to one effective range so that the effective ranges do not overlap.

15.2.4 Effective ranges working area

Introduction

The "Effective ranges" working area displays the effective ranges and their transponders in table format. You create a list of transponders and assign certain transponders to an effective range. The limit of the effective range is defined by the maximum distance from the transponders.

Principle

The working area consists of the "Effective ranges" and "Transponders" tables.

The screenshot shows the 'EFFECTIVE RANGES' working area. At the top right, there is a 'Checksum' field with the value '0000'. Below it are two tables:

Effective ranges				
Name	Display name	ID	Limits	Comment
MixingAxisControl	MixingAxisControl	1	5 m	
FillingAxisControl	FillingAxisControl	2	8 m	

Transponder			
Name	ID	Effective range	Zone
<input checked="" type="checkbox"/> Transponder_1	1	MixingAxisControl	MixingPlant
<input type="checkbox"/> Transponder_2	2		MixingPlant
<input type="checkbox"/> Transponder_3	3		FillingPlant
<input type="checkbox"/> Transponder_4	4	FillingAxisControl	

The HMI device calculates a checksum from the local data so that the configured effective ranges and transponders reliably match those locally on the machine. The project can only be started from the HMI device if the checksum calculated locally matches the checksum stored in the "Effective ranges" editor.

NOTICE

More information in this regard is available in the "Failsafe operation" function manual.

When you select a effective range from the "Effective ranges" table, the "Transponder" table displays the following:

- Transponder enabled: The transponder is assigned to the selected effective range.
- Transponder deactivated: The transponder is not yet assigned to any effective range.
- Transponder not available: The transponder has already been assigned to another effective range. To undo the assignment, switch to the relevant effective range and deactivate the transponder.
- The zone assigned to the transponder is displayed in addition to the effective range.

The effective range and transponder IDs are initially assigned automatically. They can be changed, however.

Please note the following:

- A maximum of 127 effective ranges may be configured.
- The effective range ID must be unique and fall within the range from 1 - 127.
- The display name of an effective range must not be the same as its ID.
- You can initially configure transponders without assigning them to an effective range.
- There may be no more than 255 transponders assigned to a zone, an effective range or both.
- The transponder ID must be unique and fall within the range from 1 - 65534.

The transponder IDs are set on the transponder.

NOTICE

More information in this regard is available in the "Failsafe operation" function manual.

Effective range at runtime

To log on to the effective range at runtime, only the display name of the effective range appears to the operator in the runtime language. The operator reads the effective range ID in the plant and enters it on the HMI device. This ensures that it is the right machine that is being used. The acknowledgment buttons are activated after successful logon.

15.3 Working with effective ranges

Validity

The next chapter applies only to the Mobile Panels Wireless which support failsafe operation, e.g. Mobile Panel 277 IWLAN. Configuration examples for Mobile Panels Wireless that do not support fail-safe operation can be found in the "Working with zones" section.

Introduction

The following configuration guide describes the steps needed to set up an effective range for fail-safe operation on a Mobile Panel Wireless.

NOTICE
More information in this regard is available in the "Failsafe operation" function manual.

Procedures overview

1. Configuring the effective range:
You configure the "MixingAxisControl" effective range as a conical area around "Transponder1" at a distance of 5 meters.
2. Configuring logon to the effective range:
Configure the "Effective range designation" object so that an operator can log on to the effective range at runtime.
3. Configuring additional effective range objects:
Configure additional objects for displaying the position and signal strength within an effective range.
4. Set parameters for transfer and device:
 - PROFIsafe communication
 - WLAN network
 - Power management
 - Transfer mode
5. Configure the data channel
6. Configure network operation
7. Set the transponder
8. Commissioning effective ranges
9. Switching on and Testing the HMI device
10. Starting Manual Transfer
11. Acknowledging the effective range at the plant:
You acknowledge the effective ranges and their transponders.
12. Determine checksum
13. Transferring the project once again with checksum:
Enter the checksum you determined in the project and once again transfer the project.
14. Test effective range

Note

For detailed information on items 5 to 10, refer to the operating instructions of the HMI device.

For detailed information on items 11 to 14, refer to the "Fail-safe operation of Mobile Panel 277F IWLAN" Function Manual.

Planning jobs

16.1 Field of application of the scheduler

Definition

In the scheduler, you link system functions or scripts to an event. For example, you link the SendEMail system function to the "Runtime stop" event so that an e-mail is always sent to a particular recipient at the end of operation.

A task therefore exists: When the event occurs, the linked function is called. An e-mail is sent when runtime ends.

Application example

The scheduler is used to execute event-controlled jobs automatically. For example, you use a job to automate the following:

- Regular swap out of log data
- Printout of an alarm report when an alarm buffer overflow occurs
- Printout of a report at shift end

16.2 Working with jobs and events

Introduction

A job consists of a triggering event and a "function list".

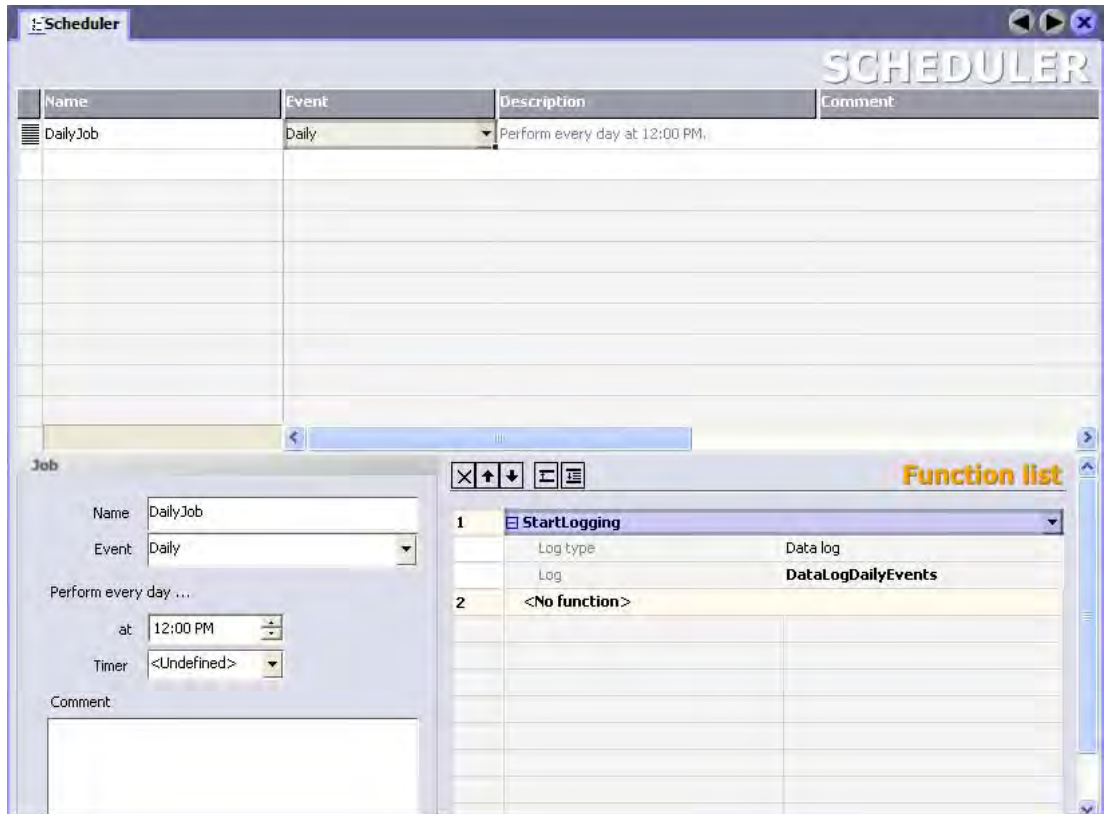

Definition

The scheduler differentiates between time-based events and system events. A time-based event occurs at a particular time, for example, "Starting daily at 12:00". Examples of system events are "Runtime stop" and "Change user".

The event occurs either cyclically, for example "Starting every day at 12:00", or acyclically, for example "Change user".

NOTICE

The events available depend on the HMI device. Not every HMI device supports all events.

The "function list" contains a system function or a script in each line.

Job sequence

When the event occurs, the scheduler starts the jobs associated with the event. The jobs are executed consecutively. A job is executed by executing the function list line-by-line.

In the case of a system event, only one job per HMI device can be configured and executed.

Note

If many jobs are executed within short intervals, time delays can occur. In the case of a cyclic event, make sure that all of the jobs are executed before the next event occurs.

Timer for time-based events

To make dynamic changes to the configured start time during runtime for daily, annual, or one-time events, select an internal tag as a timer. The value of the tag determines the start time for the job during runtime.

NOTICE
The tag must be of the "DateTime" type.

16.3 Elements

16.3.1 "Scheduler" editor

Introduction

In the scheduler, you plan a job by configuring a function list for an event.

Open

Double-click on "Scheduler" to open it in the project view.

Layout

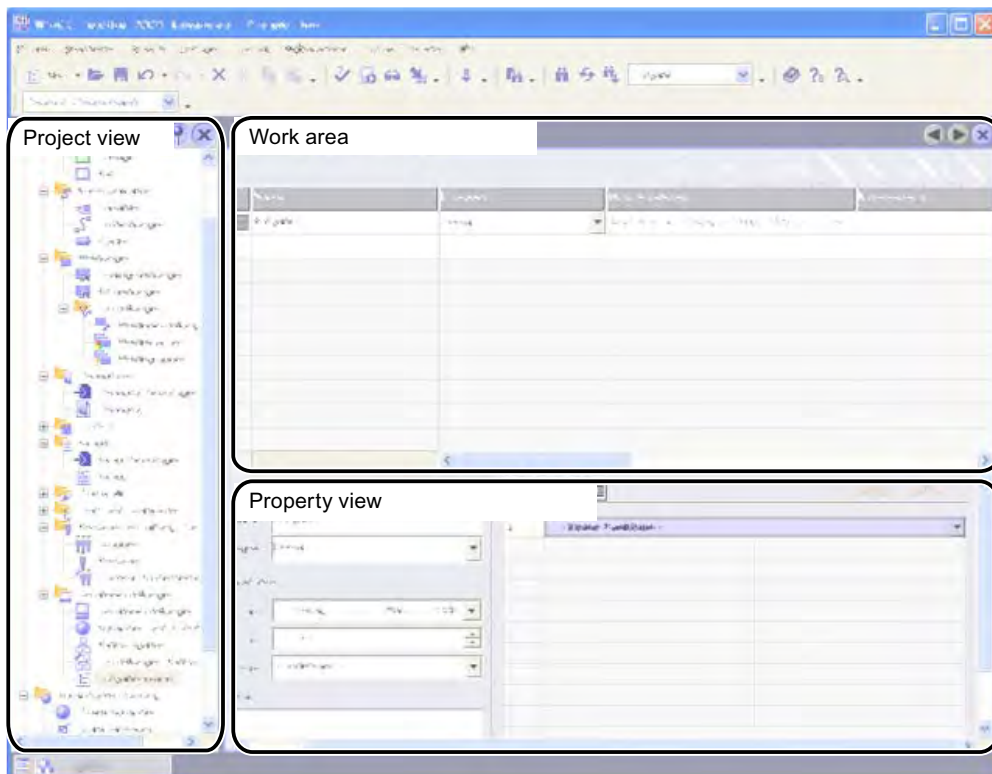

Work area

The work area shows the planned jobs.

16.3.2 Work area of the "Scheduler" editor

Introduction

The work area shows the planned jobs, which consist of the triggering event and the function list.

Layout

The work area consists of the table of jobs, the properties, and the function list.

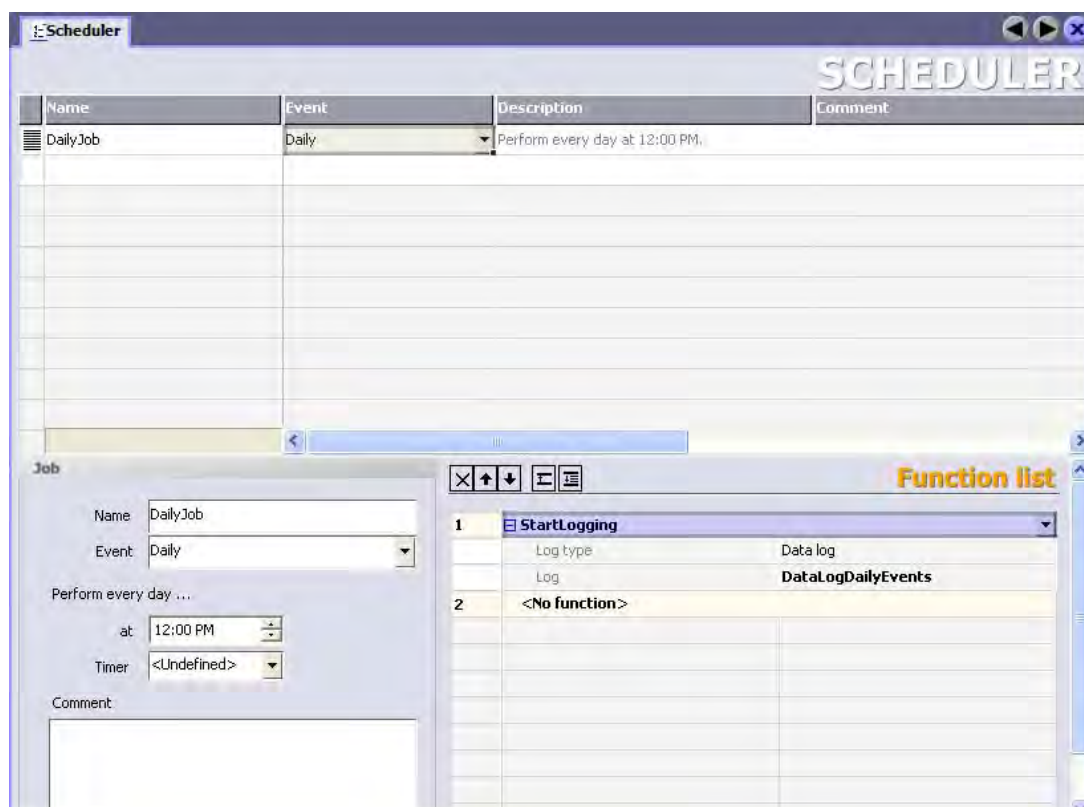

The table of jobs shows the job, the triggering event, and additional information. You assign the label and a comment and select the event. The scheduler compiles a description of the job.

The properties also show the job along with the triggering event. The time-based event is specified in the properties.

In the function list you configure the functions or scripts to be executed in the job.

Note

The compiled description provides a written summary of the job including the timing for the job. You can obtain more detailed information using the tooltip function. by moving the mouse pointer over the selected element in the user interface.

Managing project versions

17.1 Applications for project versioning

Principle

A project version is a copy of a project that is saved at a defined storage location by version management. Each project version always represents a specific project status. You can revert to an older version.

Application example

You can use project versions in the following situations:

1. To log accepted reference versions: You can revert to an older version if necessary.
2. To improve an older project version. For example, a customer may wish to correct an error in an older project version which is already being used in runtime. However, the project has been further developed in the meantime. The error is corrected in the older project version. The current project version remains unaffected at this time.
3. Assigning versions to different project states on different HMI devices: When an HMI device fails, you can always transfer the suitable project version to it.
4. Versioning alternative or experimental project configurations separately: Test versions, various device and plant types or special models of a machine.
5. Backing up data to a different medium. Loss of data, e.g. due to defective mass storage, is avoided. The most recent project version of the components for operating the plant is especially affected by this.

17.2 Basics of version management

Definition

Version management distinguishes between the project itself and the project version. A project is a file in the project folder that you can edit in WinCC flexible. A project version is a file at the "RCS" location that is saved there by the version management.

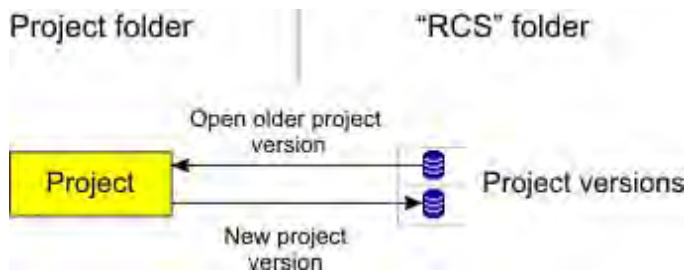

Copies are exchanged between the project folder and the "RCS" location in both directions. When a new project version is created, a copy of the project is saved in a file at the "RCS" location. When an older project version is edited, a local copy is created in the project folder.

Note

Project versions can be distinguished by sequential version numbers. The version numbers are assigned automatically in order to avoid conflicts that might occur in the branches.

Introduction

Version	State	Label	Author	Date-time	Comment
1		<Empty label>	KALLIOPE	10/30/2003 5:04 PM	<Empty comment>
2		<Empty label>	KALLIOPE	10/30/2003 5:08 PM	<Empty comment>
2.1.1		<Empty label>	KALLIOPE	10/30/2003 5:36 PM	<Empty comment>
2.1.2		<Empty label>	KALLIOPE	10/30/2003 5:38 PM	<Empty comment>
3		<Empty label>	KALLIOPE	10/30/2003 5:09 PM	<Empty comment>

You are continually developing your project. Changes are being added to changes step-by-step. If you are regularly versioning your project, sequential project versions are being created. All project versions with whole number such as 1, 2, 3 etc., form the trunk of the development.

Several branches may exist as well. The branches, for example, 2.1.1, 2.1.2, 2.1.3, are created when you edit the older project version 2 and version it regularly.

17.3 Trunk

Principle

You create a new project version to record the current state of the project. The new project version is a copy of the current project. The first project version is assigned version number "1".

NOTICE

Once a project version is saved in the version management, it can no longer be changed. Changes are always passed along to the next project version.

You are continually developing your project in WinCC flexible. Changes you are now making are based on the project state with the version 1. Version 1 is the current version.

The continuing development reaches a new milestone. You create a new project version to record the current state of the project. Version 2 is the current version.

When the next project version is created, the project status is saved as version 3.



Older project version

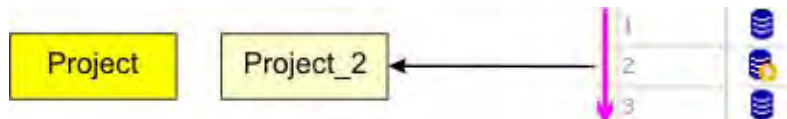

To access an older project state, open the respective project version, for example, version 2. A copy of version 2 is then created in the project folder with the name "Project_2" and opened in WinCC flexible. You can now edit the older project state in "Project_2". The changes are based on version 2. Version 2 is the current version.

17.4 Branch

Principle

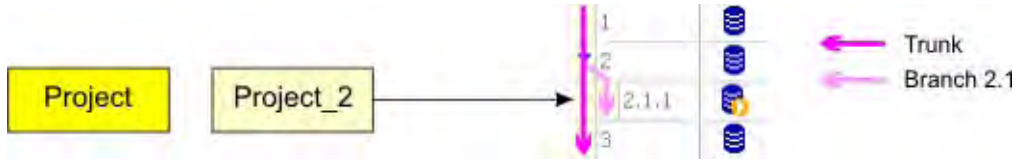

In order to record the project status of "Project_2" in the version management, create a new project version of "Project_2". Since version 3 already exists, the new project version is saved as version 2.1.1. Version 2.1.1 is the current version. The next version is 2.1.2. Now there is a branch based on version 2 in addition to the trunk development.

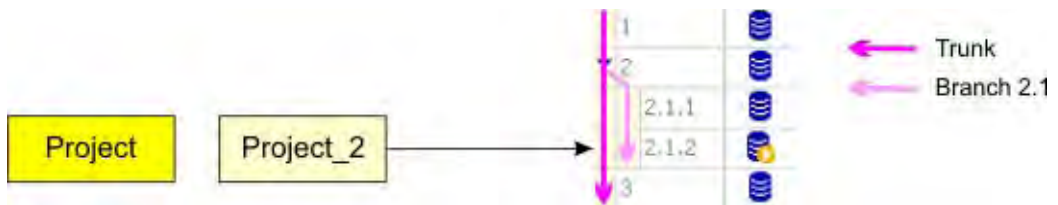

To continue the development of this branch, you always open "Project_2" in the project folder. When you create another new version of "Project_2", it will be saved as version 2.1.2. Version 2.1.1 is now the current version. Branch 2.1 is formed by all project versions, 2.1.1, 2.1.2, 2.1.3 etc.

Note

A branch always begins with a version, for example, version 2. Several branches may arise from the same version. This is why a branch is always assigned an extended version number, for example, 2.1. A project version of a branch always requires a two-number extension for its version number, for example, 2.1.2.

Additional branches

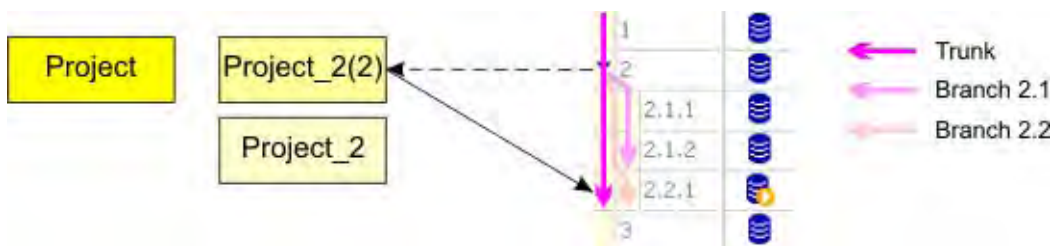

However, when you open version 2 in the version management again, "Project_2" is not overwritten in the project folder. Instead, "Project_2(2)" is saved. In "Project_2(2)" you can edit the state in version 2 once again.

A new branch numbered 2.2 is created when you now create a new project version. Branch 2.1 already exists. The new project version is saved as version 2.2.1.

However, in order to continue to work with branch 2.1, you can open the highest number of this branch, for example version 2.1.2 in the version management. As an alternative, you can open the most recently edited "Project_2" in the project folder.

17.5 Elements

17.5.1 "Project versions" editor

Introduction

The version management shows the project versions that have been created from the current project. You can create a new project version and open an older project version.

Open

You open the "Project Versions" editor in the Project view by double-clicking on "Project versions" .

Note

If you have moved the location of the project versions in another project, enter the new location in the "Reset path for project versions" dialog that subsequently appears.

Layout

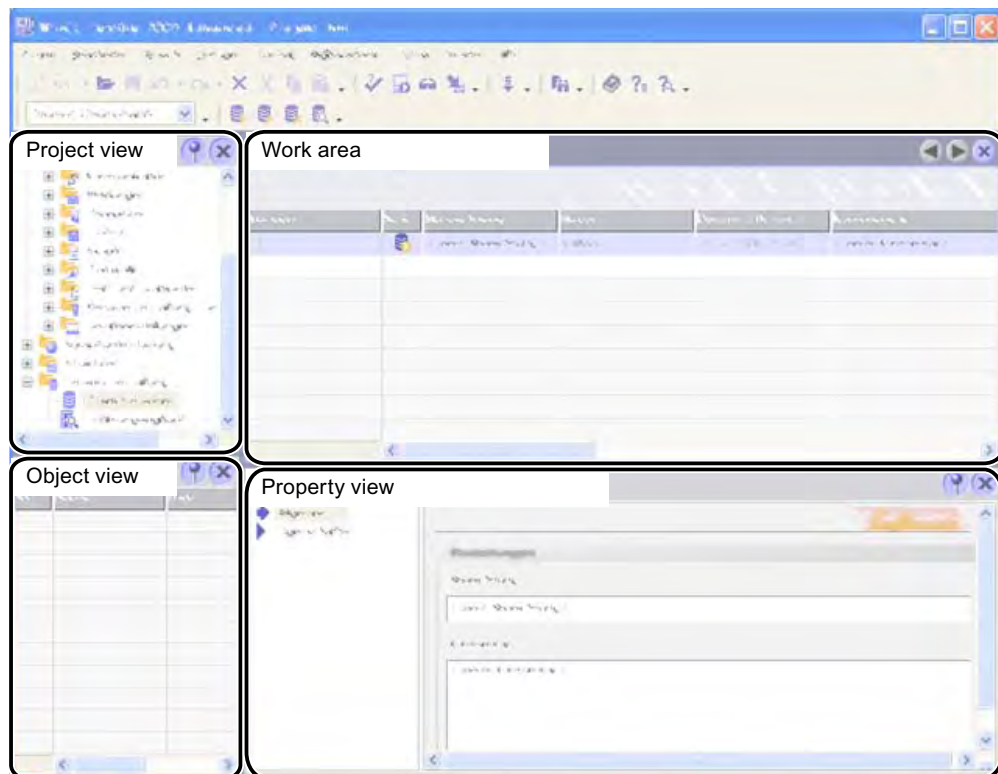

Menu bar

You can start the functions for version management from the menu bar.

Toolbar

You can start the functions for version management in the "Project versions" toolbar. The toolbar is displayed by default. The toolbar can be displayed or hidden from the context menu of the toolbar.

You can also access the version management functions in the context menu of the work area.

Work area

The work area displays the project versions that have been created.

Property view

When a project version is selected, its name and the related comment can be edited in the Property view. The current and the next version numbers are assigned by the version management.



17.5.2 Change log operator controls

Menu commands

In the "Options > Version management" menu:

Menu command	Short description	Hotkeys	Availability
Move project versions	Changes the location of the project versions		The version management contains at least one project version.

"Project versions" toolbar

Symbol	Short description	Availability
	Creating a project version	
	Opening an older project version	A project version is selected
	Delete project version	A project version is selected

17.5.3 Version Management Work Area

Introduction

The work area shows a table of the project versions that you have created from the current project. You can create a new project version and open an older ones.

Note

The work area always displays all versions of the project, even when you open an older project version.

Layout



Version	State	Label	Author	Date-time	Comment
1		<Empty label>	KALLIOPE	10/30/2003 5:04 PM	<Empty comment>
2		<Empty label>	KALLIOPE	10/30/2003 5:08 PM	<Empty comment>
2.1.1		<Empty label>	KALLIOPE	10/30/2003 5:36 PM	<Empty comment>
2.1.2		<Empty label>	KALLIOPE	10/30/2003 5:38 PM	<Empty comment>
3		<Empty label>	KALLIOPE	10/30/2003 5:09 PM	<Empty comment>

The work area contains the Tree view of the project versions. The work area displays the trunk of the project versions as the top-most level. A project version marked with the  symbol represents the beginning of a branch. You can open the view of a branch similar to a folder in the Windows Explorer.

The  icon always shows you the project version on which the current project is based. This project version is the current version.

The "Author", "Date/Time", "Version" and "Status" information is assigned by the version management. You can enter the comment and the description. The information is saved at the storage location of the project versions. When you change the comment or the name, the information is immediately updated.

17.5.4 Property view

Introduction

The Property view shows the "Name" and the comment of the selected project version in the "General" group. The Properties group shows the current and the next version of the project under "Project versions".

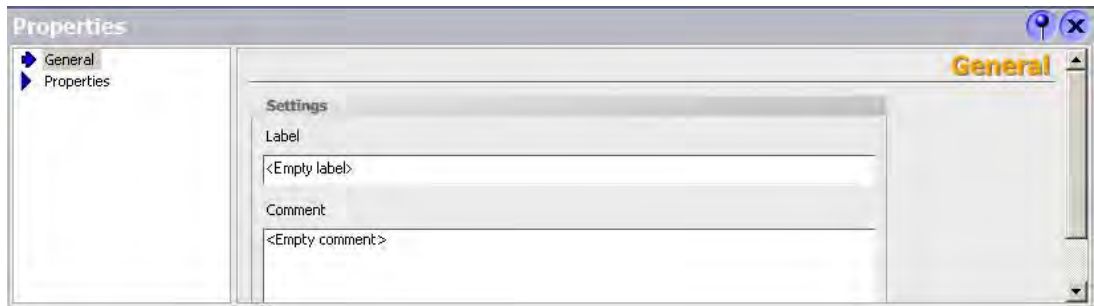

Label

The name can be used to identify different project versions over many projects, for example, "Release 01/15/2001": If you use the same name for a project version in a different project, you make it clear that these two project versions belong together, both sharing a common status of "Release 01/15/2001".

Current version and next version

The information listed under "Current version number" and "Next version number" relate to the current project. "Current version number" shows the version number of the project version on which the current project is based. "Next version number" displays the version number that will be assigned to the next version when you create a new project version.

17.6 Working with project versions

17.6.1 Comparing versions

Principle

The current project with its current status is compared to a project version. This can be the same project version on which the current project is based or a project version with a lower or higher version number.

The project version is opened and compared with the current project status. The results of the comparison are displayed in the "Compare versions" table similar to the change log.

A language change does not influence the object names determined by version comparison. To visualize object names in the new user interface language, repeat the version comparison

Introduction

The "Compare versions" table shows all the objects that have been created, deleted or modified.

Created: The object exists in the current project but not in the project version.

Deleted: The object exists in the project version but not in the current project.

Changed: The object exists in the current project and in the project version. However, the object properties are different.

When you select a changed object in the "Compare versions" table and this object has been changed in the current project, a second table is displayed. The second table shows which properties were changed for the selected object.

Logging changes

18.1 Applications for the change log

Definition

The change log documents all changes made in a project in a continuous table. The table contains the changed objects and object properties. Changes of STEP 7 and SIMOTION are not explicitly identified in an integrated project.

Application example

1. Certain industrial sectors have a special interest in complete and authentic verification of the entire lifecycle of a product and the production conditions. The evidence of who did what, when, where and why is archived. It can then be documented even years later. One example is the pharmaceutical industry.
2. The American authority FDA (Food and Drug Administration), for example, is responsible for specifying the regulations for food and drugs.

Not only do the FDA and various technical inspection companies require documentation of project changes, but many other industrial sectors and products are subject to this documentation regime.
3. Engineering businesses process customer orders in their project configuration. The customers often demand changes that go beyond the framework of the contract. The change log helps to document these changes and creates a basis for calculating the additional costs.

18.2 Change log of a project

Principle

Every project has its own change log. Project changes are recorded as long as the change log is enabled.

Recorded project changes

The following project changes are recorded:

- New change log created in WinCC flexible
- Enabling the change log
- Creating an object
- Deleting an object
- Renaming an object
- Changing an object
- Copying an object
- Moving an object
- Saving a project
- Renaming a project
- Changing comments in the change log
- Disabling the change log

The following project changes are recorded only for a project with version management:

- Creating a new project version
- Opening an old project version
- Moving project versions to another storage location

18.3 Change log of a project

Principle

The "Changes" table logs each changed object and object property in a separate line. The "Changes" table lists the object properties in detail.

CHANGE LOG						
Changes						
Name	Change	Old value	New value	Description	Author	
Change Log	Enabled			Change log was enabled.	VM	
Change Log	Initialized			Beginning of change log for version 1.	VM	
\Device_1\Screens\PictureChangeLog	Renamed	Screen_1	PictureChangeLog	Changing property Name of Screen_1	VM	
\Device_1\Screens\PictureChangeLog\Graphic IO Field_1	Created			Creating object(s)	VM	
\Device_1\Screens\PictureChangeLog\Graphic IO Field_1\Diagonal Movement\State	Changed	Disabled	Enabled	movement diagonal-Enabled	VM	
\Device_1\Screens\PictureChangeLog\Graphic IO Field_1\Diagonal Movement\Tag	Changed	<Unknown>	TagChangeLog	Changing property Tag of Diagonal Movement	VM	
\Device_1\Screens\PictureChangeLog\Graphic IO Field_1\Position	Changed	80, 112	10, 112	Changing property Start position X of Diagonal Movement	VM	
Details						
Name	Change	Old value	New value	Date-time		
\Device_1\Screens\PictureChangeLog\Graphic IO Field_1\Diagonal Movement\Movement type	Changed	<Unknown>	Diagonal	5/9/2007 2:59 PM		
\Device_1\Screens\PictureChangeLog\Graphic IO Field_1\Diagonal Movement\Start range	Changed	<Unknown>	0	5/9/2007 2:59 PM		
\Device_1\Screens\PictureChangeLog\Graphic IO Field_1\Diagonal Movement\End range	Changed	<Unknown>	1	5/9/2007 2:59 PM		
\Device_1\Screens\PictureChangeLog\Graphic IO Field_1\Diagonal Movement\Position difference X	Changed	<Unknown>	200	5/9/2007 2:59 PM		
\Device_1\Screens\PictureChangeLog\Graphic IO Field_1\Diagonal Movement\Position difference Y	Changed	<Unknown>	200	5/9/2007 2:59 PM		
\Device_1\Screens\PictureChangeLog\Graphic IO Field_1\Diagonal Movement\State	Changed	<Unknown>	Disabled	5/9/2007 2:59 PM		

Example

If you enable the change log and then initially edit an object such as "PictureChangeLog", for example, the new object is inserted as new line in the "Changes" table.

All changed object properties such as "Position" are entered a separate lines and a new value such as "200" is entered in the "Details" table.

Note

In a screen the object properties such as "Height" and "Width" are summarized under the object property "Size." A change to the height is recorded as a change to the "Size." The offset to the start position is logged instead of the change of the end position for an animation such as "Diagonal movement".

New change section

A project session consist of one or more change sections. A change section is limited by the following actions:

- Open project
- Creating a new project version
- Save project
- Enables the change log

A new change section is then started. A change section ends with the following actions:

- Close project
- Opening an older project version
- Save project again
- Disables the change log

18.4 Change log of a project under version management

Introduction

The following section describes the special circumstances for a change log when you are using version management for your project. Each project version has its own change log with additional entries.

Creating a new project version

When a new project version is created, the change log is saved along with the current project in the version management. The change log is added as the last entry, "Project Saved." The change log is then deleted in WinCC flexible.

A new change log is created with the new project version.

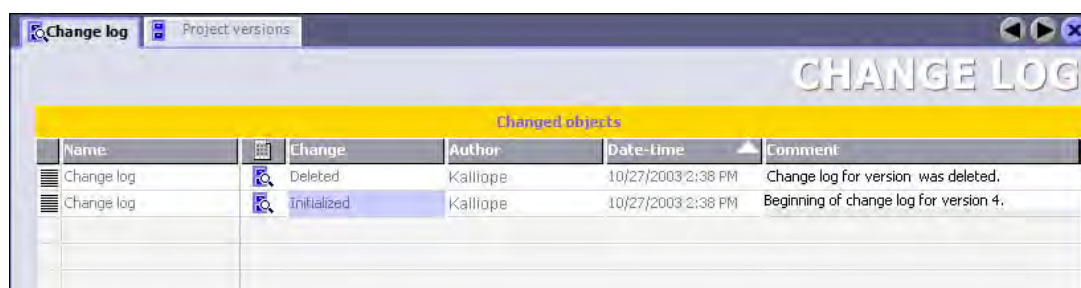

The screenshot shows a window titled "CHANGE LOG" with a "Project versions" tab. Below the title bar is a yellow header "Changed objects" above a table with the following data:

Name	Change	Author	Date-time	Comment
Change log	Deleted	Kalliope	10/27/2003 2:38 PM	Change log for version was deleted.
Change log	Initialized	Kalliope	10/27/2003 2:38 PM	Beginning of change log for version 4.

Opening an older project version

The change log is opened along with the project when an older project version is opened.

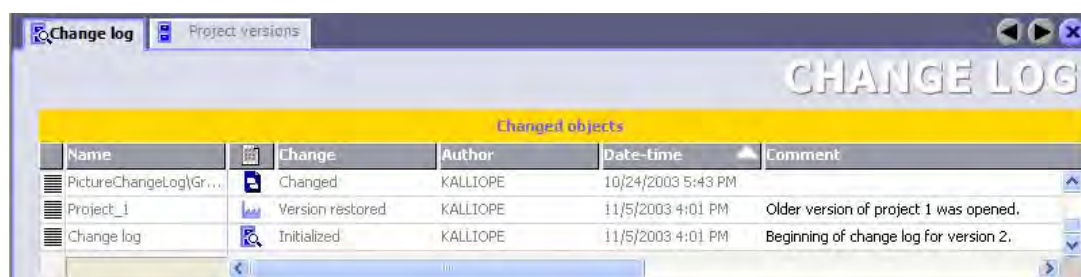

The screenshot shows a window titled "CHANGE LOG" with a "Project versions" tab. Below the title bar is a yellow header "Changed objects" above a table with the following data:

Name	Change	Author	Date-time	Comment
PictureChangeLog\Gr...	Changed	KALLIOPE	10/24/2003 5:43 PM	
Project_1	Version restored	KALLIOPE	11/5/2003 4:01 PM	Older version of project 1 was opened.
Change log	Initialized	KALLIOPE	11/5/2003 4:01 PM	Beginning of change log for version 2.

All changes to the project version are recorded as long as the change log is enabled.

Menu bar

Under the menu item "Options > Version management" you can enable and disable the change log.

Toolbar

You can open the change log from the "Project versions" toolbar.

Work area

The work area displays the modified objects and object properties.

18.5.2 Change log operator controls

Menu commands

In the "Options > Version management" menu:

Menu command	Short description	Hotkeys	Availability
"Enable change log"	Enables the change log		Change log is disabled
"Disable change log"	Disables the change log		Change log is enabled

18.5.3 Change log work area

Introduction

The work area displays the modified objects and object properties in the form of a table.

Layout

The working area consists of the "Changes" and "Details" tables.

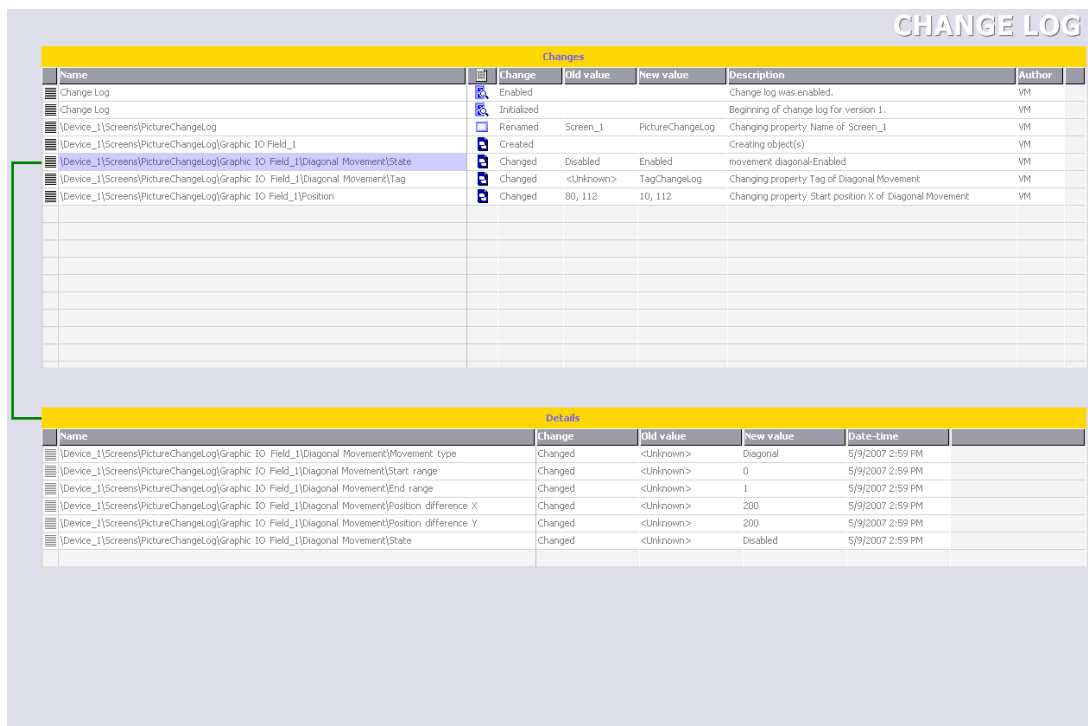

The "Changes" table shows all the objects which were created, modified, or deleted, and the changed object properties. The "Details" table opens if you select a new object from this table. The "Details" table shows the properties of a selected object in detail. The object selected from the "Changes" table and the "Details" table are interconnected with a line.

Transfer

19.1 Basics

19.1.1 Basic Principles of the Transfer Operation

Transfer

A transfer operation refers to the transfer of a complete project file to the HMI devices where the project is to run.

Select the "Project > Compiler > Compile" or the "Project > Compiler > Rebuild all" menu command to check consistency of the project after having completed a configuration.

Note**Rebuild all**

Recompile the entire project by executing the "Rebuild all" command before releasing your project to the production process.

It is also advisable to execute a "Rebuild all..." command at suitable intervals to reduce the time required for compiling delta data in current engineering sessions.

Execute a full compilation by selecting the "Project > Compiler > Rebuild all..." menu command.

The "Select HMI devices for generation" dialog opens after you have called the "Rebuild all..." command and if you have configured several HMI devices.

Select the HMI devices to be generated from this dialog. Multiple selection is possible.

After completing the consistency check, the system generates a compiled project file. This project file has the same name assigned to it as the project, however with the extension "*.fwx". Transfer the compiled project file to the configured HMI devices.

Note

Because of the diagnostics messages, the fwx file can be fairly large. If the size of the fwx file is preventing you from transferring this file to the HMI device, you should disable the diagnostics messages in the alarm settings.

The HMI devices must be connected to the configuration computer to transfer the project data. If the HMI device is a PC, it is also possible to perform the transfer operation using data media such as diskettes.

Compile the project again if the *.pwx is not found and you receive an error message while transferring the data.

Basic procedure

1. Enter the transfer settings for the individual HMI devices in your WinCC flexible project.
2. Enter the transfer mode on the HMI device where the project is to be transferred.
3. Transfer the compiled project file from the configuration computer to the HMI devices.
The project file is transferred to all HMI devices for which the respective check box is selected in the transfer settings.

Transfer mode

The HMI device must be in "transfer mode" for the transfer operation. Depending on the type of HMI device, transfer mode is enabled as follows:

- Windows CE systems

The HMI device starts up automatically in transfer mode when the device is commissioned the first time.

The HMI device switches automatically to transfer mode at the start of each additional transfer operation if this transfer option is enabled on the configuration menu of the HMI device.

If not, restart the HMI device and call the transfer applet on the Start menu, or configure the "Change Operating Mode" system function in your project.

- PCs

If the HMI device is a PC that does not yet contain a project, you must enable the transfer mode in the "RT Loader" manually before the first transfer operation.

Refer to your manual for more detailed instructions on setting the transfer mode on the HMI device.

Note

Transferring operating systems with MP 377 on PROFIBUS

Due to the size of the image and the baud rates available at PROFIBUS, an image transfer at the MP 377 using PROFIBUS can take up to an hour.

Transfer operating systems or images via USB or Ethernet.

HMI device version

When transferring a project onto the operator device, the system checks if the configured operating system version corresponds with the version on the HMI device. If the system finds different versions the transfer is aborted and a message is displayed. You have following possibilities if the version of the operating system in the WinCC flexible project and on the HMI device are different:

- Update the operating system on the HMI device.

You can find further information in chapter "Operating System Transfer".

19.1.2 Transfer settings

Introduction

You can enter transfer settings individually for each HMI device of your project. The transfer settings include communication settings and the HMI device selection for the transfer operation.

The "Transfer settings" dialog allows you to enter only those settings that are actually available for the selected HMI device.

Selecting the HMI device for the transfer operation

When a transfer operation is performed, the compiled project file is transferred to all HMI devices of the project for which the respective check box is selected in the transfer settings on the configuration computer.

The relevant check box must be selected in the transfer settings on the configuration computer even if you use the shortcut menu of the HMI device to start the transfer operation for this particular HMI device only.

Transfer modes

Depending on the HMI device, you can use one or more of the following transfer modes:

- Direct connection (USB cable (host-to-host), serial cable)

Transfer takes place by means of a serial cable or a USB cable connecting the configuration computer and HMI device.

Note

Always select the highest possible transmission rate for a transfer operation by means of a serial cable. At lower transmission rates, it can easily take hours for the quantity of data to be transferred.

If the transfer via USB fails, unplug the USB cable at both ends (PC and HMI), and then insert it again.

Note

ProSave running on devices with Windows CE operating system only supports transfers in standalone mode if you are using an USB/PPI cable.

The USB/PPI cable is only approved for OS updates but not for communication. For additional information on HMI devices for which the USB/PPI cable has been approved, see:

- WinCC flexible Help:
WinCC flexible Information System > Utilities for Service and Development > ProSave > Device-dependent transfer interfaces
 - ProSave help:
ProSave > Device-dependent transfer interfaces
-

- Ethernet network connection

The configuration computer and HMI device are located in a network or are connected point-to-point. The transfer operation between the configuration computer and the HMI device takes place by means of an Ethernet connection.

- MPI/DP

The configuration computer and HMI device are in an MPI network or PROFIBUS DP network. The corresponding protocol is used for the transfer operation.

- Http

Transfers are based on the http protocol, for example via Intranet or Internet.

The settings described below are prerequisite for HTTP transfers.

"Internet Settings" of the configuration computer: A permanent Proxy Server may not be set for the HTTP connections.

"Internet Settings" of the HMI device: The "Enable remote transfer" check box must be activated on the "Web Server" tab.

A user with "Engineering" permissions must have been set up on the HMI device.

- File

The project file is transferred to the specified destination directory.

- S7Ethernet

The configuration computer and HMI device are located in a network or are connected point-to-point. The transfer operation between the configuration computer and the HMI device takes place by means of an Ethernet connection.

S7Ethernet is transfer channel that can be used for routing. Routing is only supported for integrated operation of WinCC flexible in STEP7.

The configuration computer/HMI device are connected to one of the following networks:

- MPI
- PROFIBUS DP
- Ethernet

The transfer mode setting for an HMI device is also applied if the HMI device is selected in the project view and one of the commands on the "Project > Transfer" menu is selected (for example, in the case of a back transfer operation or when the operating system is updated on the HMI device).

Transfer to the OP 73micro, TP 170micro, TP 177micro, OP 73, OP 77A and TP 177A HMIs

The "RS 232 / PPI Multi Master Cable" (6ES7 901-3CB30-0XA0) serial cable is required to transfer project data to the OP 73micro, TP 170micro, TP 177micro, OP 73, OP 77A and TP 177A HMIs. It is imperative that DIL switch 5 is set to 0.

Only serial transfer is possible at micro operating panels. All other HMIs support either serial data transfer or MPI transfer. By changing the transfer mode of a channel in the transfer settings, you disable the corresponding other channel.

OP 73, OP 77A and TP 177A HMIs do not support simultaneous data transfer via MPI from several active instances of WinCC flexible to multiple HMIs. These devices only execute the initial first transfer request.

Transfer destination

On Windows CE HMI devices, you can store the compiled project file to the Flash memory or RAM of the HMI device.

Delta transfer on Windows CE devices

To save time in the transfer, only delta transfers can be performed on Windows CE HMI devices. In the case of a delta transfer, only project data that has changed relative to the data on the HMI device is transferred.

During a delta transfer, it is possible to transfer data to the RAM memory. This is advisable if a new configuration is to be tested without loss of the old configuration. After a shutdown/restart of the HMI device, the configuration transferred to the RAM is lost and the configuration stored in the Flash memory is again applicable.

"Delta transfer" is the default setting for Windows CE HMI devices. You can change this default setting in the transfer settings to force the entire project to be transferred. It may be necessary to transfer the entire project, for example, if an executable project file no longer exists on the HMI device due to a malfunction or inconsistency after the delta transfer.

Note

If the HMI device is a PC, the complete data file is always transferred.

Upload

When transferring, you can transfer the compressed source data file along with the compiled project file to the HMI device. The compressed source data file is stored on the HMI device with the same name as the project but with the extension *.pdz added.

If necessary, you can back transfer this source data file onto any configuration computer. Thus, you can analyze and continue processing the original project on a computer other than the original configuration computer at a later time.

NOTICE

The source data file can be stored on the HMI device for back transfer purposes only if sufficient memory is available externally on the HMI device.
--

Overwriting the user administration data and recipes

During the transfer of a compiled project file, user administration data and the recipes which already exist on the HMI device are overwritten with corresponding configuration data. This allows you to create recipes and user administration data as part of the project and make this data available on all HMI devices to which the project was transferred. During transfer, the compressed recipe data is transferred to the HMI device. When the transfer has ended, runtime starts on the HMI device and decompresses the recipe data. It then imports this into the project. After import, a system alarm is generated. Prior to concluding import you must not export any recipe data. You can only start an export or import of recipe data on the HMI device once the system alarm for a successful import / export has been issued.

Deactivate the corresponding check box to prevent overwriting of user administration data and recipes. You should always generate a backup copy of existing user management and recipe data on the HMI device to protect your data. You can restore user management and recipe data from this backup file once transfer is complete.

Transfer of recipe data records with specification of date or time

If you use date or time specifications in recipes, the system settings for time and date on the configuration computer and on the destination device must be in concordance. After transferring to the destination device, you should check the recipes with date or time specifications on the destination device.

19.1.3 Transfer via USB

Introduction

Via a USB connection you have the possibility of connecting a configuration computer and an HMI device to each other, and transferring projects in both directions. To do this you require a suitable USB host-to-host cable and the USB driver available on the WinCC flexible CD 2. It is only possible to transfer via USB on Windows CE-based HMI devices with a USB interface.

Note

Use exclusively the USB drivers available on the WinCC flexible CD 2 as otherwise problems could occur when transferring.

Data has already been successfully exchanged between configuration computers and HMI devices using USB host-to-host cables of other manufacturers. Refer to the following site for more information on the cables to be used and the manufacturers / suppliers:
["http://support.automation.siemens.com/WW/view/en/19142034"](http://support.automation.siemens.com/WW/view/en/19142034)

Transfer via USB

To ensure that the data transfer with the USB host-to-host cable runs smoothly, you must comply with the following conditions:

- You are using a USB host-to-host cable.
- You have already installed the drivers from the WinCC flexible CD 2.
- The HMI device being used is based on Windows CE and has a USB interface.
You will find an overview of the Windows CE-based HMI devices under the chapter "Device-based dependency of interface".

If all the conditions have been fulfilled then the configuration computer can be linked with the HMI device and the data transfer can start.

19.1.4 Back transfer of projects

Introduction

When transferring, you can transfer the compressed source data file along with the compiled project file to the HMI device. This source data file is required for the project to be back transferred from the HMI device to a configuration computer. The upload of integrated projects is not supported.

Use for back transfer

Normally, only the executable project is transferred to the HMI device during a transfer operation. The original project data remain on the configuration device and are thus available to develop the project further in future or for error analysis.

However, on Windows CE devices with an external storage medium and on PCs, you can store not only the compiled project file but also the compressed source data file for the project. This data file can be used at a later time to recover the project from the HMI device or device by back transferring the source data file to a configuration computer.

Advantage:

The back transfer operation enables you to subsequently perform analyses and make changes to an existing project even if the original configuration device is not available or the source file (*.hmi) for the project is no longer available on the configuration device.

Note

You can also use WinCC flexible to transfer the source data file of a ProTool project back from the HMI device onto a configuration computer. You can then perform a migration of the ProTool project to a WinCC flexible project.

The source data of a ProTool project which was configured for an operating device not supported by WinCC flexible must be transferred back to a configuration computer with ProTool. Save the ProTool project. Then execute a migration using WinCC flexible.

Requirements for back transfer

- The source data file can only be transferred to the HMI device as part of the transfer operation for the compiled project file. The source data file is transferred along with the compiled project file to the HMI device if the "Enable back transfer" check box is selected in the transfer settings for the respective HMI device.
- There must be sufficient memory available on the HMI device to store the compressed source data file. If the source data file for the back transfer operation is provided by a Windows CE device, this device must have an external memory card. If the HMI device does not have a memory card or if there is insufficient memory space, the transfer is terminated. However, the compiled project file is transferred in its entirety beforehand so that runtime can be started with the transferred project data.

If the source data of a large project should be stored for back transfer and an Ethernet connection is available to the operating device, you can select a network drive as the storage location rather than the memory card of the operating device. This avoids problems with the storage location.

- If there is no project opened in WinCC flexible, you must select the HMI device on which the source data file for the back transfer operation is located and the loading method in the "Communication settings" dialog prior to carrying out the back transfer operation.

If a project is open in WinCC flexible, the back transfer operation takes place from each selected HMI device. In this case, the transfer mode selected for this HMI device in the "Transfer Settings" dialog in WinCC flexible is applied.

Transfer and back transfer

When a source file is included in the transfer operation, the project is compressed from the source format (*.hmi) and transferred as a *.pdz file to the external storage medium of the HMI device or directly to the PC.

In the case of a back transfer operation, the *.pdz file is saved on the configuration computer. If a project was open in WinCC flexible during the back transfer, you are prompted to save and close it. Then, the project back transferred is decompressed and opened in WinCC flexible. When saving the project, you must assign a name for the back transferred project.

 **CAUTION**

WinCC flexible cannot check whether the source data file on the operating unit actually belongs to the project running on the device. If you have performed a transfer operation in the interim that did not include the source data file, old project data may still be on the HMI device. Under certain circumstances, the data will then no longer match the project that is currently running.

Note

Use the back transfer process preferably for small and medium sized configurations in order to keep transfer times as short as possible.

You have the following options when there are numerous project files: Transfer the project file as a compressed *.arj file onto a CF card, for example, using the backup function of the project manager.

19.2 Managing Files on the HMI Device

19.2.1 ProSave

Introduction

The ProSave service tool is supplied with WinCC flexible. The functionality of ProSave is integrated into the WinCC flexible user interface on the programming device. ProSave can also be installed as a stand-alone program on a computer where WinCC flexible is not installed ("stand-alone operation").

Functional scope

ProSave provides all of the functions needed to transfer files to the HMI device.

- Data backup and restoration of backed-up data
- Operating system update for Windows CE-based devices
- Transferring authorizations
- Installing and uninstalling drivers and options as well as information on installed options and options that can be installed on an HMI device
- Communication settings

Integrated operation on the configuration computer

ProSave is installed on the configuration computer as part of a standard WinCC flexible installation. The complete functional scope of ProSave is integrated within WinCC flexible on the "Project > Transfer" menu.

Stand-alone operation on a computer

ProSave can also be installed on a computer from the WinCC flexible CD and used without WinCC flexible being installed (for example, for service purposes).

When replacing a device, for example, you can use ProSave to back up a project from the original HMI device and restore it on a replacement device without having WinCC flexible installed.

If you are using ProSave outside of WinCC flexible, you have the option to change the user interface language. To select a language, use the "Language" menu command in ProSave. ProSave must be restarted for the language switch to take effect.

19.2.2 Backup of HMI data

Introduction

The data on an HMI device should be backed up at regular intervals.

A data backup allows you to quickly resume operation after a system failure or when a device was replaced. The backup data are simply transferred to the new HMI, and thus restore the original state.

Data backup using WinCC flexible or ProSave

You can use WinCC flexible and a programming device which is connected to the HMI to backup and restore all HMI data.

If the computer does not have WinCC flexible installed, you have the convenient option of using ProSave to perform a centralized backup.

Scope of data backup

The backup and restore operation depends on the type of HMI device and can include the following project data:

- Complete backup (depending on the HMI device: Runtime, firmware, operating system image, configuration, recipes, passwords, and settings, but not authorizations)
- Recipes only
- Passwords only

A backup file with the extension *.psb is generated when you backup the HMI data.

The backup can be made to any memory medium, such as a data server, if an appropriate connection exists between the HMI device and the memory medium.

Note

Only use the restore function for project data on operating devices configured using the same configuration software.

If, for example, WinCC flexible recipe data is restored on a device configured using ProTool, the Flash memory can no longer be read. Delete the Flash memory, in this case, and transfer the ProTool project again.

Note

Note the following when performing a complete data file backup and restore operation for Windows CE devices:

Authorizations are not backed up!

When a complete data restoration is carried out, all of the data that were previously on the device, including authorizations and the operating system, are irrevocably deleted.

If an interruption occurred while data was being restored, you must first reload the operating system onto the HMI device via the "bootstrap" mechanism before resuming the data restoration.

All installed options are also backed up, but not the associated authorizations. Basically, all the data for the option that are still available after "POWER OFF" are backed up.

Note

If at all possible, you should use USB or Ethernet to back up and restore data because use of these interfaces will result in the shortest transfer times.

Note

For Windows CE devices, a direct data backup can be performed from the device to an external storage medium, namely a CF card or PC card. For additional information, refer to the relevant operating instructions.

19.2.3 Updating the operating system

Introduction

If the operating system version on a Windows CE device is not compatible with the configuration, the transfer of the configuration is cancelled. A message appears indicating the operating system must be updated.

Updating the operating system

Note

The operating system can only be updated on Windows non-PC-based HMI devices.

If an HMI device is connected to a configuration PC, you can update the operating system from the configuration PC by using WinCC flexible.

If the computer does not have WinCC flexible installed, you have the option of using ProSave to update the operating system of the HMI device.

NOTICE

Do not use a serial connection to transfer the operating system. The transfer operation can take up to an hour if a serial cable is used.

When an operating system is updated, all of the data on the destination device, including authorizations, are deleted. Therefore, use the "Authorizations" function to transfer the authorizations back onto the license diskette beforehand.

If you want to continue to use any user data (such as passwords and recipes) stored in the internal Flash memory once the operating system is updated, you must export the data to an external data memory beforehand and reload them onto the HMI device following the update.

"Bootstrapping"

If the operating system update was terminated prematurely, an operating system will no longer be available on the HMI device. A "bootstrap" operation is then the only option available for loading an operating system.

When an operating system is updated, the communication between the configuration computer and the HMI device takes place by means of the operating system of the HMI device. During a "bootstrap" operation, however, the configuration computer communicates with the boot loader of the HMI device. Depending on the HMI device, the communication is possible via the following connections:

- Via the serial connection
- Via Ethernet for HMI devices without serial ports

The bootstrap operation can take time.

Once the "bootstrap" operation has been started in WinCC flexible, power on the HMI device must be switched off and on again (booted), so that the HMI device can communicate by means of the boot loader.

19.2.4 Transferring authorizations

Transferring license keys

In order to install certain WinCC flexible runtime options the corresponding License keys must be available on the License Key storage location. Transfer the required License Keys to the HMI device during installation by means of the configuration PC.

You can also return the License Keys to the License Key storage location, for example, to make these available for use on a different HMI device.

CAUTION

To prevent irrevocable loss of license keys, you must transfer the license keys for an HMI device back onto the license key diskette in the following cases:

- Prior to the update of the operating system of a Windows CE HMI device
- Prior to restoring a complete database from the backup copy

License keys on an HMI device are backed up depending on the HMI device configuration. For detailed information, refer to the operating instructions of the corresponding HMI device.

19.2.5 Installation of options

Available options

You can install additional options supplied with WinCC flexible on HMI devices at a later time. Likewise, you can install options purchased separately from WinCC flexible at a later time.

The HMI device type determines which options can be installed.

For an overview of available options, refer to "Introduction to WinCC flexible".

Integration of WinCC flexible in STEP 7

20.1 Basic Principles

20.1.1 Restrictions for integrated projects

Introduction

The following restrictions apply for the integrated operation of WinCC flexible in STEP 7 or in SIMOTION:

- Version management can not be used.
- Upload is not possible.
- Changes of STEP 7 or SIMOTION are not explicitly identified in the log of changes.

20.1.2 Converting integrated projects

Introduction

The conversion of projects to other versions of WinCC flexible is also possible in integrated projects. When using converted projects, you have to use the released versions of the programs involved in integration. For integrated projects, a distinction should be made between the following constellations:

- WinCC flexible project integrated into STEP7
with additional ProAgent components
- WinCC flexible project integrated in SIMOTION SCOUT project

Converting a WinCC flexible project integrated in STEP 7

You can find information on converting a WinCC flexible project integrated in STEP 7 in the chapter "Conversion of WinCC flexible projects integrated in STEP 7".

Converting a WinCC flexible project integrated in SIMOTION SCOUT

With a WinCC flexible project that is integrated in SIMOTION SCOUT, you first have to save the surrounding SIMOTION project in the desired product version. The target version of SIMOTION determines the valid version of the WinCC flexible project contained there. If you select a SIMOTION project version without HMI support, a message is displayed. If the SIMOTION project is saved in the desired version, the WinCC flexible project contained there is converted. The conversion of the WinCC flexible project runs as a background process. You don't need to open the project in WinCC flexible for conversion. You can find further information in the SIMOTION SCOUT documentation in the chapter "SIMATIC WinCC flexible integrated in SIMOTION SCOUT".

Note

When you convert a WinCC flexible project in integrated mode, the software checks the version. The SIMOTION Scout project is converted first followed by the integrated WinCC flexible project. Only the WinCC flexible versions that are released for the selected SIMOTION Scout Version are offered to you in the conversion dialog. When you convert a WinCC flexible project in non-integrated mode and open a SIMOTION Scout project from WinCC flexible, you have to check the product version yourself.

Converting a project with ProAgent components

When you convert a WinCC flexible project, the ProAgent components contained there are also automatically converted.

When you open a WinCC flexible project from an earlier version with a newer version of WinCC flexible, the project, including the ProAgent components contained there, is converted to the newer version.

When you save a WinCC flexible project in an earlier version, the project, including the ProAgent components contained there, are converted to the selected version and saved. The original project and the ProAgent components contained there remain unchanged.

The suitable ProAgent version for the selected WinCC flexible version is automatically selected by the system.

New functions from a more current ProAgent version are not available in an earlier version of ProAgent. Sequencers must be regenerated after conversion.

20.1.3 Basic principles of integration in STEP 7

Introduction

If you are using a SIMATIC PLC and have installed the STEP 7 configuration software on your system, you can integrate WinCC flexible in STEP 7.

Advantages of integrating in STEP 7

During integrated configuration, you access STEP 7 configuration data that you created when you configured the PLC with STEP 7. This gives you the following advantages:

- You can use the SIMATIC Manager as a central point for creating, processing, and managing SIMATIC PLCs and WinCC flexible projects.
- The communication parameters of the PLC are preassigned when the WinCC flexible project is created. When a change takes place in STEP 7, the communication parameters are updated in WinCC flexible.

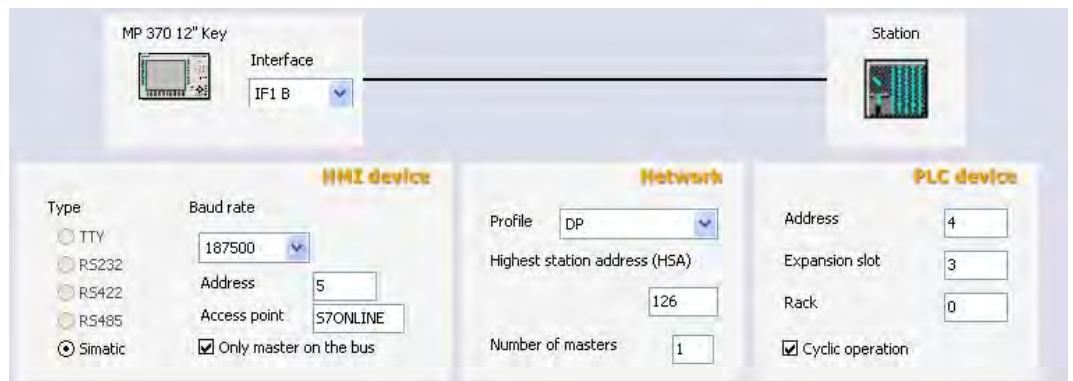

Connection parameters created by the system during STEP 7 integration: Network parameters and partner parameters are preassigned

- When configuring tags and area pointers, you can access the STEP 7 symbols directly in WinCC flexible. In WinCC flexible, simply select the STEP 7 symbol to which you would like to link a tag. Symbol changes made in STEP 7 are updated in WinCC flexible.
- You assign a symbolic name once in STEP 7 and use it in STEP 7 and WinCC flexible.
- ALARM_S and ALARM_D alarms configured in STEP 7 are supported in WinCC flexible and can be output on the HMI device.
- You can create a WinCC flexible project without integration in STEP 7 and integrate it in STEP 7 at a later time.
- You can remove an integrated project from STEP 7 and use it as a standalone project.
- In a STEP 7 multiproject, communication connections can be configured across projects.

Installation requirements

A specific installation sequence must be followed to integrate WinCC flexible in STEP 7. You must first install the STEP 7 software, and then WinCC flexible. When installing WinCC flexible, it detects an existing STEP 7 installation and automatically installs the support for integration in STEP 7.

For user-guided installation, the "Integration in STEP 7" option must be activated.

If WinCC flexible is already installed and STEP 7 is installed subsequently, WinCC flexible must be uninstalled and reinstalled once the STEP 7 installation is complete.

20.1.4 Working with the SIMATIC Manager

Introduction

When you are working with WinCC flexible integrated in STEP 7, you can use the SIMATIC Manager for your WinCC flexible projects. In STEP 7 projects, the SIMATIC Manager is the central point for managing your projects, including your WinCC flexible projects. The SIMATIC Manager enables you to access the configuration of your automation systems and the configuration of the operator control and monitoring layer.

Requirement

WinCC flexible is integrated in SIMATIC STEP 7.

Working with the SIMATIC Manager

In integrated projects, the SIMATIC Manager provides the following options:

- Create an HMI or PC station with WinCC flexible Runtime
- Insert WinCC flexible objects
- Create WinCC flexible folders
- Open WinCC flexible projects
- Compile and transfer WinCC flexible projects
- Export and import texts for translation
- Specify language settings
- Copy or move WinCC flexible projects
- Archive and retrieve WinCC flexible projects within the framework of STEP 7 projects

20.1.5 Working with HW Config

Introduction

The HW Config editor is provided in STEP 7 for configuring and assigning parameters to the hardware. Use drag-and-drop operations to assemble the required hardware. A catalog is provided for selecting the hardware components. During configuration, a configuration table with the address parameters is automatically created. During subsequent editing in STEP 7 or WinCC flexible, the system accesses this configuration table and accepts the prepared parameters.

Using HW Config

You use HW Config to create the hardware configuration for new stations or to add required modules to existing stations. HW Config provides a catalog with the available modules and preconfigured components and stations. HW Config checks the usability of the objects you wish to insert. Thus, unusable or illegal objects cannot be inserted. Edit the properties of an inserted object directly in HW Config. Open the context menu of the object and select "Object Properties". Edit the object properties directly in the dialog that appears.

For example, you can create a PC station in the SIMATIC Manager. Open the station for configuration in HW Config. Insert a WinCC flexible runtime application. Select a communication interface and insert it. Edit the settings for the communication interface in HW Config. The WinCC flexible runtime application will not open via HW Config. To open it, use SIMATIC Manager.

For more information, consult the HW Config documentation.

20.1.6 Configuring connections

Introduction

Data exchange between WinCC flexible and the automation layer requires connections for communication to take place. In integrated projects, you can create connections with the following applications:

- WinCC flexible
- NetPro

This configuration can be made with either WinCC flexible or NetPro.

Using WinCC flexible

You can create new connections or edit existing ones. In integrated projects, the "Station," "Partner," and "Nodes" columns are also provided in the editor for connection configuration.

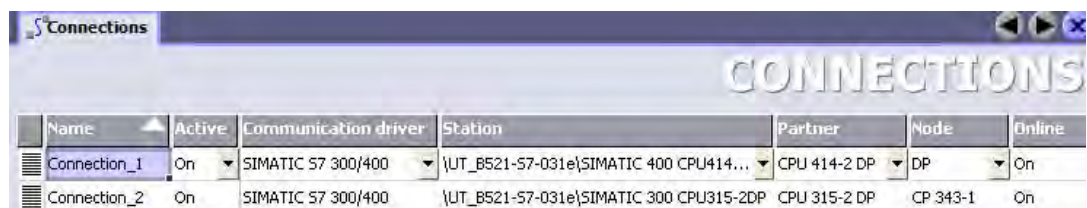

Name	Active	Communication driver	Station	Partner	Node	Online
Connection_1	On	SIMATIC S7 300/400	\\UT_B521-S7-031e\\SIMATIC 400 CPU414...	CPU 414-2 DP	DP	On
Connection_2	On	SIMATIC S7 300/400	\\UT_B521-S7-031e\\SIMATIC 300 CPU315-2DP	CPU 315-2 DP	CP 343-1	On

When creating a connection, select the station, partner, and connection node from selection lists. The required connection parameters are automatically accepted in STEP 7. The project has to be saved after configuration has been completed. Connections which you configure in WinCC flexible are not transferred to NetPro and can only be edited with WinCC flexible.

Using NetPro

NetPro is recommended for use with larger projects. In NetPro, you configure the connections on a graphically supported interface. When you start up NetPro, the devices and subnets in the STEP 7 project will be displayed. NetPro has a catalog of network objects that you can use to insert additional devices or subnets. In integrated projects, this catalog also includes the SIMATIC HMI station object. You insert objects from the catalog in the work area of NetPro using a drag-and-drop operation. Drag and drop individual stations to connect them to the subnets. Use Properties dialog boxes to configure the connection parameters of the nodes and subnets. You then save the configuration in NetPro to update the data management in the WinCC flexible project. Connections which you configure with NetPro can only be read in WinCC flexible. In WinCC flexible you can only rename the connection, enter a comment for the connection and set the connection "Online". Editing of the connection itself is carried out exclusively with NetPro.

Note

Subnet properties, such as the data transmission rate, are set automatically in STEP 7 for all nodes in a subnet. If you create or modify the subnet properties yourself, you must ensure that these settings are applied for each node in the subnet. You can find more information on this topic in the NetPro documentation.

Note

If a new HMI station is set up in STEP 7, the MPI/DP nodes are set to MPI and Address 1 by the system. If the HMI station is not networked and the HMI station should be networked via a different substation type, the connection parameters must be changed in NetPro or in the HW configuration.

20.1.7 Working with objects

Introduction

Perform the following steps to create an integrated WinCC flexible project:

- Create a new HMI station in the SIMATIC Manager
- Integrate a WinCC flexible project in STEP 7.

Creating an HMI station

Creating an HMI station in the SIMATIC Manager basically creates a new WinCC flexible project.

Inserting multiple HMI devices in a WinCC flexible project

If you require multiple HMI devices in a WinCC flexible project, you must insert the HMI devices in the project in WinCC flexible.

Inserting WinCC flexible objects

Once a WinCC flexible project has been integrated in STEP 7, the project is displayed in the project window of the SIMATIC Manager. A WinCC flexible project is displayed in the project window of the SIMATIC Manager in the same way as in the project window of WinCC flexible. If you select a WinCC flexible element in the project window, the objects of the WinCC flexible project are displayed in the work area.

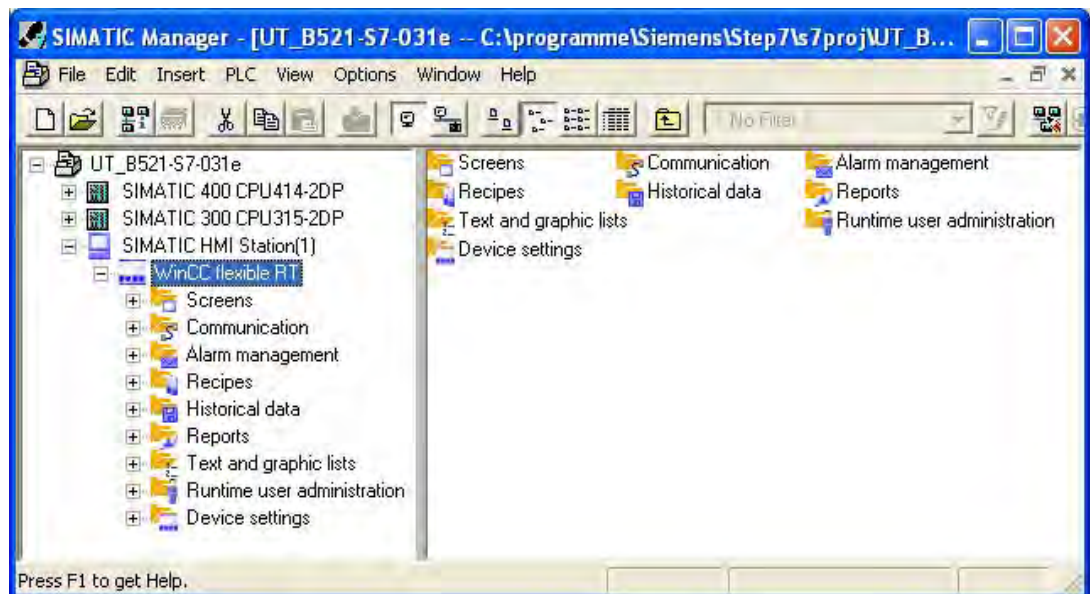

From here, you can open existing projects or create new ones. If you create or open a WinCC flexible object in the SIMATIC Manager, WinCC flexible is automatically started for editing the object.

Select, for example, the "Screens" element and create a WinCC flexible screen directly in the SIMATIC Manager. The new screen will be created and opened immediately for editing in WinCC flexible. Or create a log of changes in which all the changes of the project are documented in a continuous table. Changes of STEP 7 are not explicitly identified in the log of changes.

Note

Working with integrated projects depends on the rights of the Windows user who is logged on. You need at least write access for this. If the Windows user opens an integrated project with only read access, he can not make any changes. Data cannot be synchronized between STEP 7 and WinCC flexible with read access.

Representing WinCC flexible objects

Global project elements that cannot be edited in the SIMATIC Manager are not displayed; examples of such elements include version management and language settings.

Data that you edit in WinCC flexible with a table editor are displayed as symbols in the SIMATIC Manager. Opening such symbols via the SIMATIC Manager causes WinCC flexible to open for editing the data. For example, if you select the "Tag" element, a symbol for all WinCC flexible tags will be displayed in the work area of the SIMATIC Manager. The individual WinCC flexible tags are not displayed in the SIMATIC Manager. If you create a new tag in the SIMATIC Manager, it will be created in WinCC flexible and opened for editing in WinCC flexible.

For more information about STEP 7, consult the SIMATIC Manager documentation.

Changing the names of STEP 7 data blocks

If you change the name of a STEP 7 data block, it can happen that the old name is displayed in the object list of WinCC flexible. To make sure that the changed name of the STEP 7 data block is displayed in the object list, open the list again in the WinCC flexible project integrated into STEP 7.

Renaming a WinCC flexible project

The renaming of an integrated WinCC flexible project in SIMATIC Manager is only of temporary nature. After having opened and renamed the project in WinCC flexible, you changes will be lost if do not save the project before you close it again.

20.1.8 Converting an integrated project

20.1.8.1 Conversion of integrated WinCC flexible projects in STEP 7

Introduction

A WinCC flexible project integrated in STEP 7 can be saved in a different product version of WinCC flexible. When saving a project in a different product version the project is converted. A number of special features should be observed in comparison with a non-integrated project. If a WinCC flexible project is integrated in STEP 7, the WinCC flexible project is an integral component of the STEP 7 project. The conversion of the WinCC flexible project is carried out in WinCC flexible. During the conversion process only the WinCC flexible project is converted, the surrounding STEP 7 project remains unchanged.

Conditions of conversion

If you want to convert a project integrated in STEP 7, you must have a STEP 7 installation in which the corresponding WinCC flexible version is integrated.

Example:

You created a project integrated in STEP 7 with WinCC flexible 2005 SP1 and save the project in the version WinCC flexible 2004 SP1.

To edit the project in this version, you require WinCC flexible 2004 SP1 integrated in STEP 7. The STEP 7 version is the same for both WinCC flexible versions.

STEP 7 can be used from version V5.3 SP2 and later. If newer versions are used, please observe the information about supported WinCC flexible versions.

The integration of multiple versions of WinCC flexible in a STEP 7 installation is not possible. For every version of WinCC flexible you need a PC with a STEP 7 installation. Information on transferring a STEP 7 project to a different PC can be found in the STEP 7 documentation.

If a STEP 7 project contains several WinCC flexible projects, each of these WinCC flexible projects must be converted separately. During conversion of a WinCC flexible project, the data for all the HMI devices contained there are converted. If a WinCC flexible project contains several HMI devices, they are displayed as individual HMI stations in the project window of STEP 7.

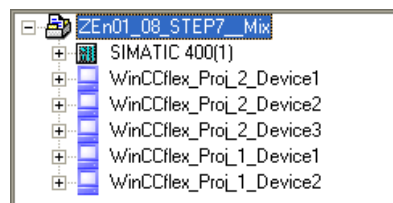

The conversion of a single WinCC flexible project containing several HMI devices may therefore affect several HMI stations displayed in STEP 7. With a converted project, the valid WinCC flexible version is written to the properties of the HMI stations affected. To display the properties, open the shortcut menu of an HMI station and select the menu command "Properties". The HMI used is displayed after the entry "Device". The HMI-device version is found in parentheses and the valid WinCC flexible version e.g. "MP 370 12" Key (7.1.0.0, 2005) is found after the comma. The WinCC flexible version is not displayed for a non-converted HMI station.

If you reopen an already converted WinCC flexible project in the current version environment, the dialog for reconversion to the current version is opened. When converting several WinCC flexible projects, please ensure that you convert all the projects to the same version.

You must convert the project after having copied an HMI device in STEP 7 or NetPro which was not created in the current version of WinCC flexible. The system requests you to confirm conversion of the project. You cannot copy the Runtime of a project which is not converted to the current version. The Runtime is excluded from the copy operation you initiated. This copy of the HMI device is therefore incomplete and must be deleted.

System requirements for converted projects

To edit a converted project, you require WinCC flexible in the version selected during conversion. A service pack in the version specified must be installed. Please also note the system requirements and any service packs required for the operating system. Information on the system requirements can be found in the documentation of the respective version of WinCC flexible or STEP 7. With regard to an invalid HMI device, check whether a hardware support package is available for the corresponding version of WinCC flexible. For more information, please refer to the chapter "Retroactive installation of new HMI devices".

20.1.8.2 Converting an integrated project to the current WinCC flexible version

Introduction

An integrated WinCC flexible project from an earlier version is automatically converted if it is opened with a newer version of WinCC flexible. Before conversion is started, the system asks for your confirmation.

Requirement

- You must have a STEP 7 project in which a WinCC flexible project from an earlier version of WinCC flexible is integrated.
- You must have STEP 7 and a newer version of WinCC flexible installed.
- The surrounding STEP 7 project must be open in the SIMATIC Manager.

Procedure

1. Open the project node of the WinCC flexible project in the project window of the SIMATIC Manager and select the "WinCC flexible RT" entry.
2. Open the shortcut menu and select the "Open Object" command. WinCC flexible is started.
A dialog warning you of the upcoming conversion is opened.
3. To start conversion, confirm the warning dialog with "OK".
The conversion of the project to the current version of WinCC flexible is performed.
4. If you click "Cancel", the process is canceled and the project is not opened.

Result

The system has converted the integrated WinCC flexible project and it can be edited in the current version of WinCC flexible. Functionality which is also found in the target version of WinCC flexible is fully converted, post-configuration is not necessary for this. Functionality which is not supported in the target version is not available after conversion, post-configuration may be necessary for this.

Note

The HMI devices included in the project are converted where necessary to the appropriate HMI-device versions for the WinCC flexible version.

20.1.8.3 Converting an integrated project to an earlier WinCC flexible version

Introduction

You can save an integrated WinCC flexible project from a current version to an earlier version of WinCC flexible. Before conversion is started, the system asks for your confirmation.

Requirement

- You must have a STEP 7 project in which a WinCC flexible project from a current version of WinCC flexible is integrated.
- You must have STEP 7 and a current version of WinCC flexible installed.
- The surrounding STEP 7 project must be open in the SIMATIC Manager.

Procedure

1. Open the project node of the WinCC flexible project in the project window of the SIMATIC Manager and select the "WinCC flexible RT" entry.
2. Open the shortcut menu and select the "Open Object" command. The project opens in WinCC flexible
3. In WinCC flexible, select the menu command "Project > Save as version". A dialog with notes on conversion is displayed.
4. In the dialog, select the desired WinCC flexible version in the drop-down list box "Save as version".
5. To start conversion, click "OK" in the dialog.
The conversion of the project to the selected version of WinCC flexible is performed. The project is closed.
6. If you click "Cancel", the process is canceled and the project is not converted.

Result

The system has converted the integrated WinCC flexible project and it can be edited in the selected version of WinCC flexible. Functionality which is also found in the target version of WinCC flexible is fully converted, post-configuration is not necessary for this. Functionality which is not supported in the target version is not available after conversion, post-configuration may be necessary for this.

Note

The HMI devices included in the project are converted to the appropriate HMI-device versions for the WinCC flexible version. If an HMI device is not available in the earlier version of WinCC flexible, the Device Selection dialog is displayed. Select a different HMI. New functions from a more current WinCC flexible version are not supported in an earlier version of WinCC flexible.

20.1.9 Integrating WinCC flexible in a PC Station

Introduction

The SIMATIC PC station represents a PC or an OS station that contains SIMATIC components for automation tasks, e.g., WinCC flexible Runtime and a slot PLC or soft PLC. WinCC flexible Runtime can be integrated and configured as HMI software in a PC station.

The HW Config editor is provided in STEP 7 to configure the PC station.

Configuring a PC station

A preconfigured PC station is provided in WinCC flexible. To configure a new PC station, insert a SIMATIC HMI station in the STEP 7 project and select the "PCs ▶ WinCC flexible RT" as the HMI device. The system will create a SIMATIC HMI station with a "PC" type HMI device. Additional configuration settings for the PC station, such as adding a slot PLC or a soft PLC, are made with HW Config. In integrated projects, the catalog of HW Config is expanded so that you can insert all required components in the PC configuration using a drag-and-drop operation.

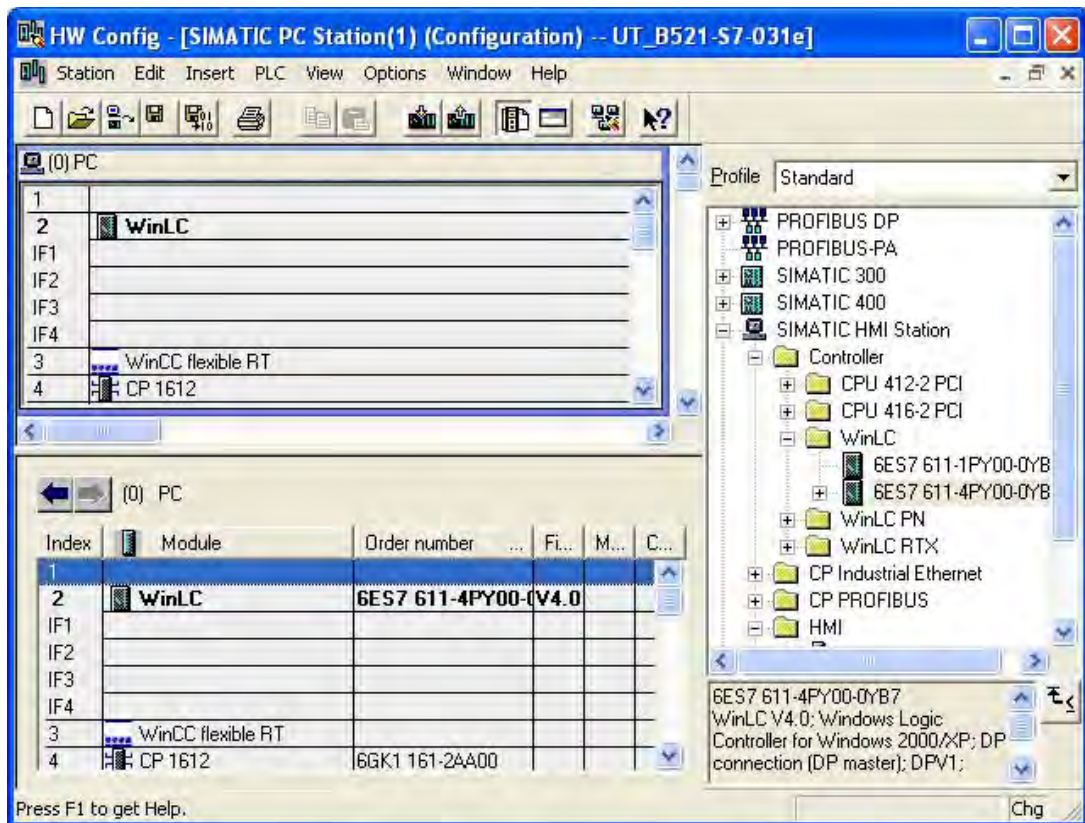

Internal and external communication

In a PC station, the internal communication between WinCC flexible RT and a PLC device contained occurs via the softbus. The internal connection over the softbus is configured in WinCC flexible. The connection to the softbus is automatic. You only need to select the PLC device in the "Station" column of the connection. Communication with external automation devices takes place by means of either the integrated interface of the PLC device or a separate communication module that you insert with HW Config.

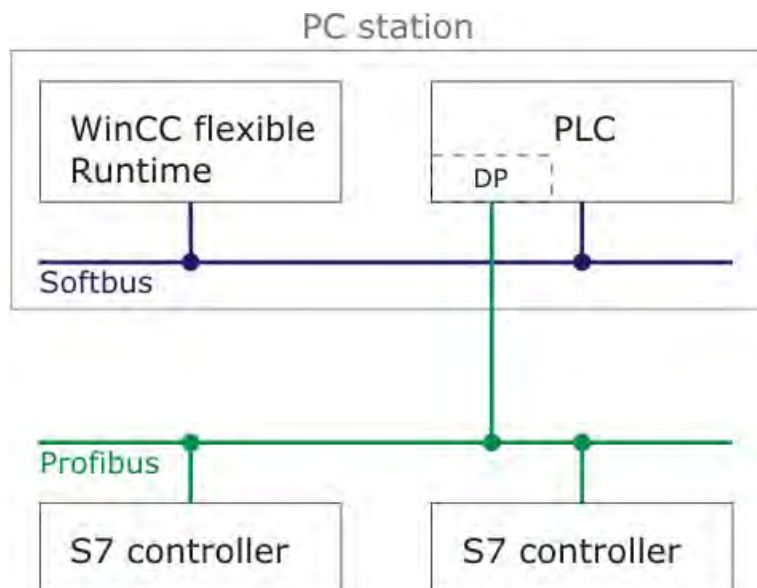

The communication is managed by the Station Manager. In order to enable management by the Station Manager, the S7RTM flag must be set in the PC station properties. An approved version of the SIMATIC Net Software must have been installed on the target station.

You can find more information on this topic in the SIMATIC Net documentation.

20.2 Configuring communication settings

20.2.1 Configuring communication settings via routing

Introduction

If all stations in an automation system are not connected to the same bus (subnetwork), these stations cannot be accessed directly online. To establish a connection to these devices, a router must be interposed. In this case, a SIMATIC station can also act as a router if it has appropriate interfaces with the difference subnetworks. Modules with communication capability (CPUs or CPs) used to establish gateways between the subnetworks must have routing capability.

The routing path is determined in Runtime by the system and cannot be influenced by the user. During configuration it is therefore not possible to output information about any faulty connection.

A routing HMI within this routing path may prevent proper operation of this connection. Usually, HMI devices cannot be used as routers. An exception is a PC on which the S7-RTM flag is set. This requires the SIMATIC NET software.

Routing connection

To create a routing connection, all communication partners must be configured and loaded in a STEP 7 project.

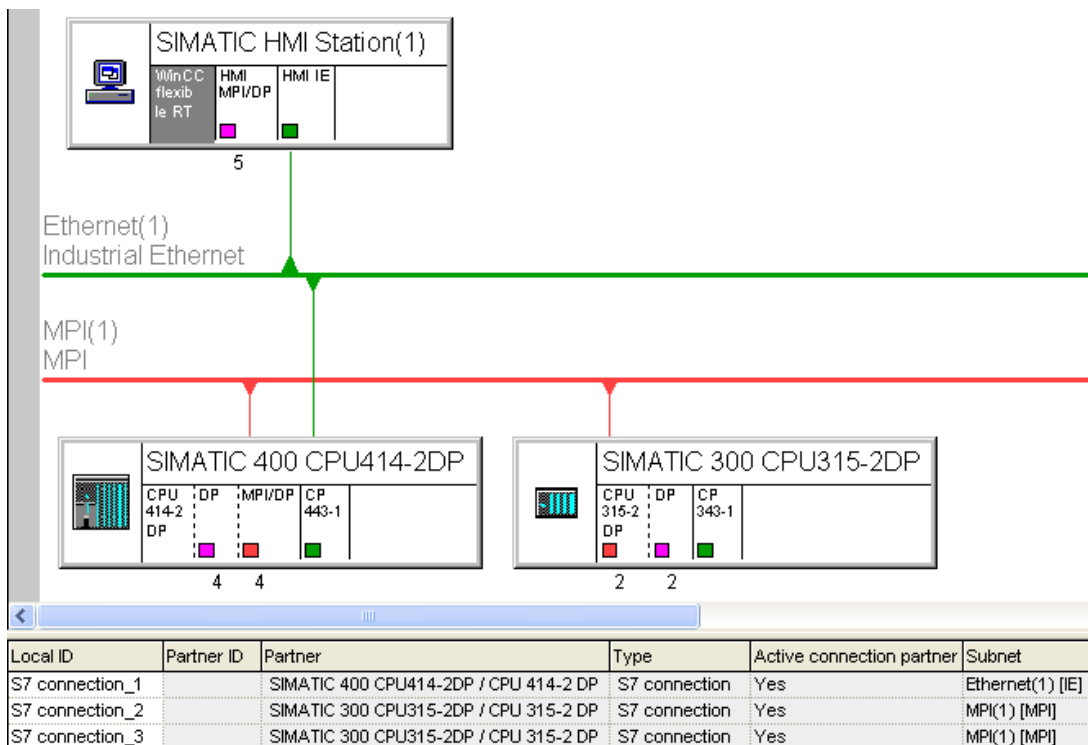

Illustration of a hardware configuration with a routing connection

In the figure above, a routing connection is established between the SIMATIC HMI station (1) and the SIMATIC 300 automation device. The SIMATIC 400 automation device is acting as a router. In integrated projects, this type of routing connection can be established directly. This is done by setting up a connection in the SIMATIC HMI station and directly selecting the SIMATIC 300 automation device as the connection partner. The routing connection is detected automatically by the system. The connection is displayed as a routing connection in the connection properties in WinCC flexible.



A routing connection between a SIMATIC HMI station and an automation device can only be created in an integrated project.

20.2.2 Project transfer via S7 routing

Introduction

WinCC flexible supports the download of a WinCC flexible project from a configuration computer to an HMI device across different subnets. To establish a connection between different subnetworks, a router must be interposed. In this case, a SIMATIC station can act as a router if it has appropriate interfaces to the different subnetworks. Modules with communication capability (CPUs or CPs) used to establish gateways between the subnetworks must have routing capability.

To transfer a project, the WinCC flexible Engineering Station must be connected to an MPI bus, PROFIBUS or Ethernet. The HMI device to which the project is to be transferred must also be connected to an MPI bus, PROFIBUS or Ethernet.

The routing connection for the transfer is independent of the connection configuration between the HMI device and the automation device in your WinCC flexible project. The connection described in this chapter is only for the transfer of a WinCC flexible project to an HMI device over a routing connection.

Note

Please see the technical documentation for the respective component to determine whether a component can be routed. Alternatively, open the object properties for the component in NetPro or in HW Config. The "General" tab contains a short description of the properties.

OP 73, OP 73micro, OP 77A, TP177A und TP 177micro HMI devices do not support S7 Routing for the transfer of projects.

Routing connection for the transfer operation

To create a routing connection, all stations must be configured and loaded within a STEP 7 project. The target device cannot be initialized over the routing connection.

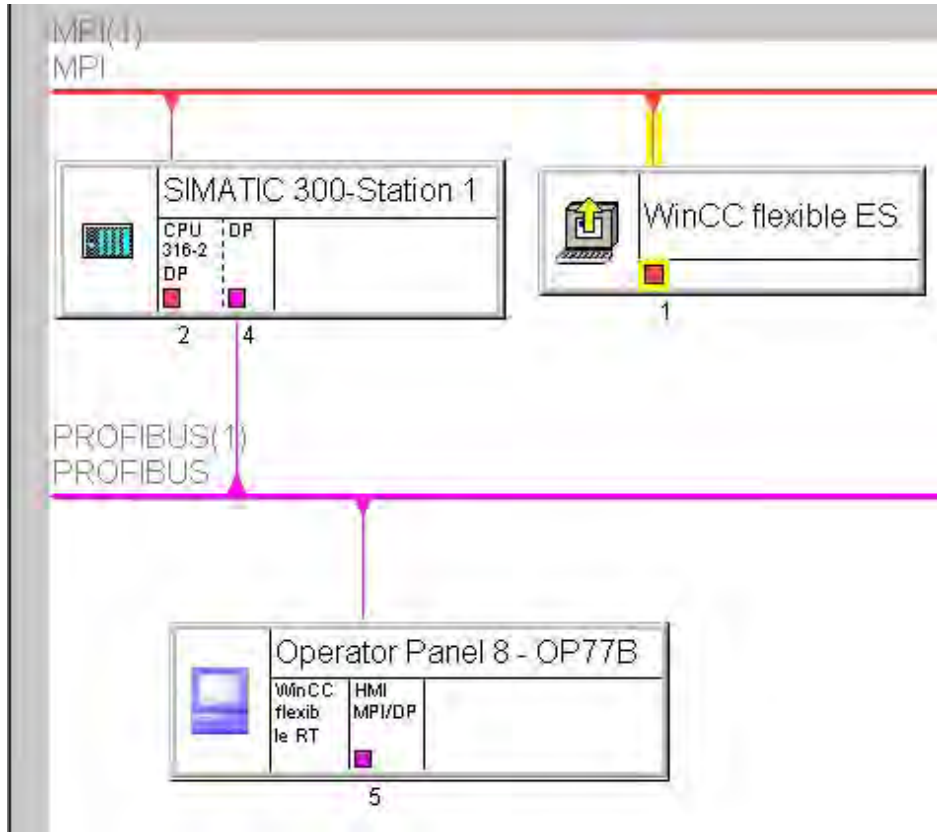
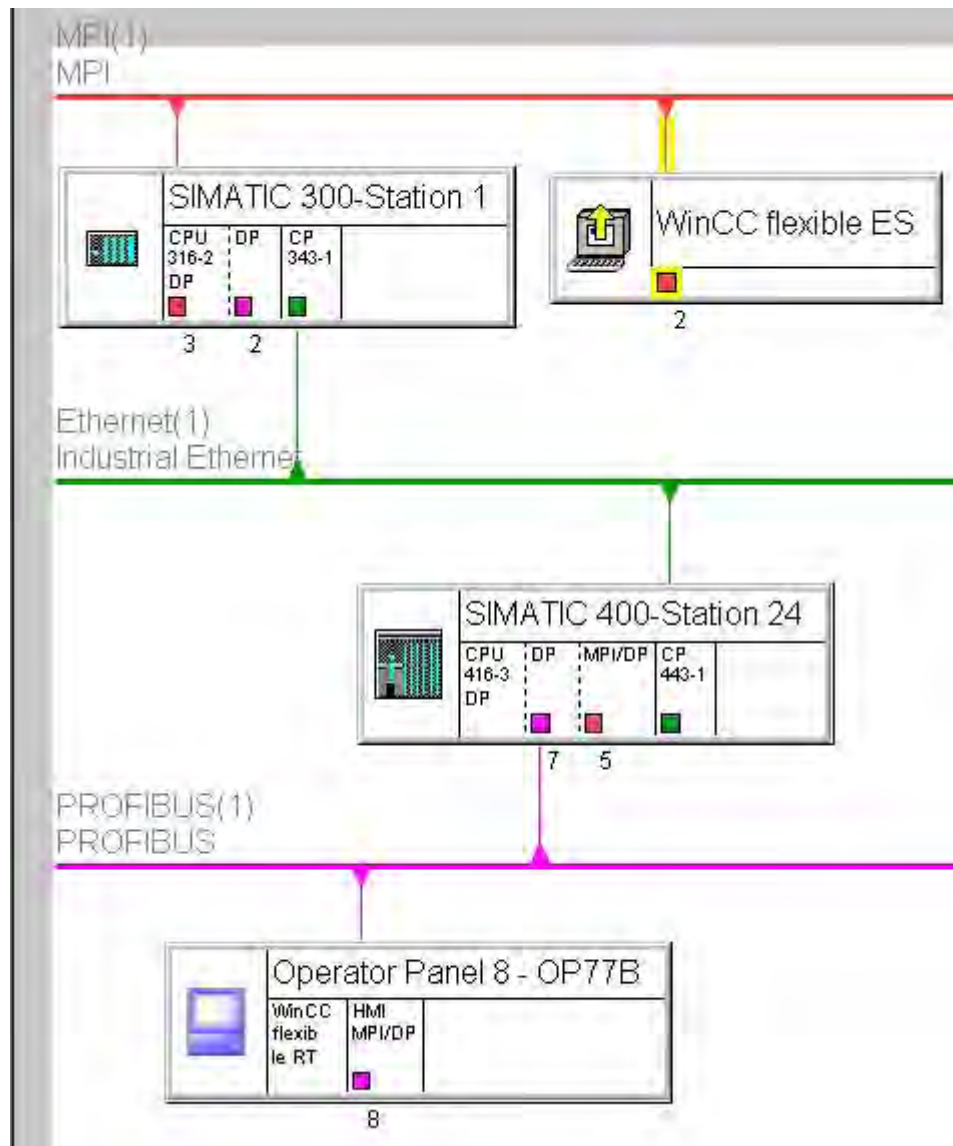

Illustration of a routing connection for the transfer operation

In the above figure, a routing connection was established between the "WinCC flexible ES" WinCC flexible Engineering Station and the "Operator Panel 8 - OP77B" HMI device. The "SIMATIC 300-Station 1" automation device functions as the router. You configure the transfer connection between the concerned devices with NetPro. The interface of the configuration computer must be assigned. The association is indicated by the yellow connection line to the subnetwork and the yellow arrow in the symbol of the station. After the configuration in NetPro, save and recompile the project.



over several stations

Requirements for routing over several stations:

- The WinCC flexible Engineering Station must be connected to an MPI bus, PROFIBUS or Ethernet.
- The HMI device to which the transfer operation should take place must be connected to an MPI bus, PROFIBUS or Ethernet.

Starting the transfer in WinCC flexible

After configuration in STEP 7 is complete, open the HMI station in WinCC flexible. To trigger the transfer, select the "Project ► Transfer ► Transfer Settings" menu command.

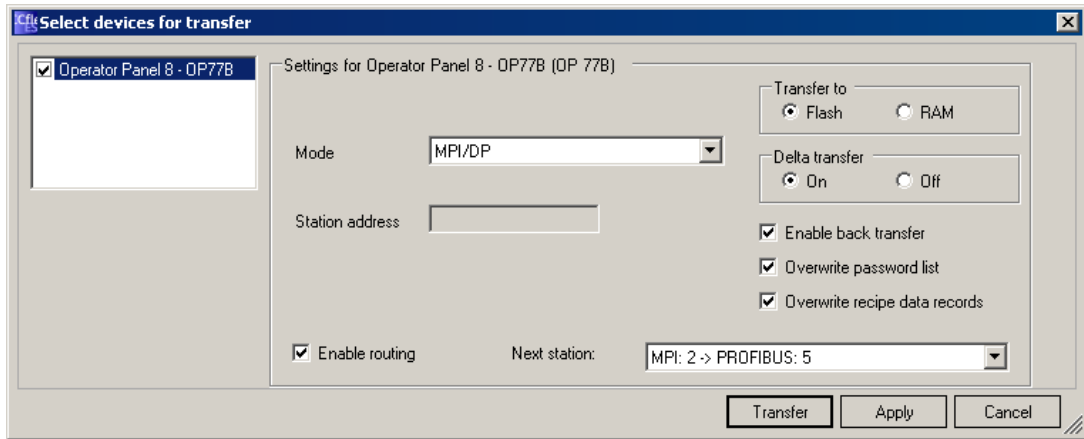

Transfer settings

"MPI/DP" must be set in the "Mode" field.

The "Enable routing" box must be checked.

The "Next station" field shows the bus type of the next and last connection and the network address of the next routing partner and the target device. Any potential intermediate routing partners are not shown here.

If you click the "Transfer" button, the transfer will start right away.

The routing settings are only made available, if you have set the bus type to "MPI/DP" of "S7Ethernet" under Mode. If the settings for the routing are not displayed, the system cannot identify a persistent routing connection. Check the settings and the network addresses of the concerned stations. The configured parameters must match the configuration of the stations on the system.

A routing connection for the transfer can only be established in an integrated project.

Note

The routing transfer to PC-based HMI devices with enabled station manager is not possible.

20.3 Tag configuration

20.3.1 Configuring tags with the Tag editor

Introduction

To simplify editing, the absolute addresses of operands have symbolic names (symbols) in STEP 7. These symbols and their associations are listed in a symbol table. In integrated projects, WinCC flexible tags are connected directly to the symbols from the STEP 7 project. The associated operands are automatically assumed. The symbol selection also enables direct access to symbols within data blocks (DB). In order to rewire a tag which directly accesses a DB, double-click the icon in the "Rewire" dialog box to open the DB directly in STEP 7. Modify the tag connection in the open DB.

Accepting tags from STEP 7

To accept tags from STEP 7, open the tag editor in WinCC flexible. A "Symbol" column is added to the Tag editor in integrated projects. Insert a new tag in the tag editor. Position the mouse pointer over the field in the Symbol column and click to display the selection button. Press the selection button to open the Selection dialog and navigate to the S7 program in the required PLC. Select the required symbol from the symbol list or from a data block.

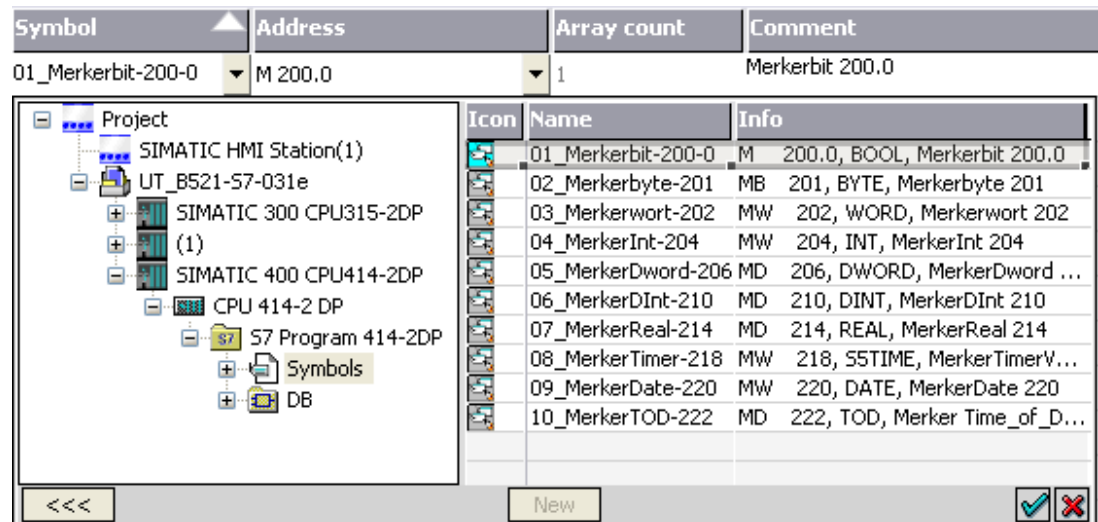

Click on the command button. The symbolic name from STEP 7 will be accepted as the tag name. The relevant data from the symbol table or data blocks will be integrated in the WinCC flexible tag.

The tag names, transferred from STEP 7 to the WinCC flexible project, are generated from the components of the general STEP 7 symbol. The tag name "Motor.Speed" is derived from "Motor.Speed" for example.

For unique identification, an index starting with "1" is assigned to identical tags. Non-supported characters in a tag name are replaced by an underscore ("_").

Transferring an array from STEP 7

If you are using a SIMATIC S7 300, SIMATIC S7 400, or a SIMOTION PLC, you can accept entire arrays from STEP 7 in addition to tags.

If you are using the SIMATIC 300/400 control protocol and you would like to accept arrays in WinCC flexible, proceed as follows:

1. Create a new tag in WinCC flexible.
2. Position the mouse pointer and click in the "Symbol" field of this tag; press the button that appears to open the selection dialog.
3. Navigate to the required PLC and select the array you want to accept. A tag group corresponding to the number of array elements will be created.

Changing a connection

When you make changes to a connection, e.g., by changing a node, a program, or a station, the symbol association of a tag is not lost. The tag association is automatically reassigned to the STEP 7 symbol.

If a tag can no longer be assigned because the address or symbol does not exist, you have the following options:

- Save the association
The tag will be labeled defective. The tag in question must be connected manually.
- Separate tag from symbol
This tag will no longer be compared automatically with the STEP 7 symbol.

20.3.2 Connecting a tag via the application point

Introduction

Connections between WinCC flexible objects and operands in the control layer are configured simply by selecting the symbols in the connected PLC.

Accepting tags from STEP 7

All WinCC flexible objects that can be connected to a tag can be used to accept tags via the application point. For example, when you make an IO field dynamic, you open the selection dialog for the tag in the Properties window of the IO field. Navigate to the S7 program in the required PLC. Select the required symbol from the symbol list or from a data block. Click on the  command button. The system automatically creates a WinCC flexible tag and connects it to the associated operand in STEP 7.

The symbolic name from STEP 7 will be accepted as the tag name. The relevant data from the symbol table or data blocks will be integrated in the WinCC flexible tag.

The tag names, transferred from STEP 7 to the WinCC flexible project, are generated from the components of the general STEP 7 symbol. The tag name "Motor_Speed" is derived from "Motor.Speed" for example.

For unique identification, an index starting with "1" is assigned to identical tags. Non-supported characters in a tag name are replaced by an underscore ("_").

Changing a connection

When you make changes to a connection, e.g., by changing a node, a program, or a station, the symbol association of a tag is not lost. The tag association is automatically reassigned to the STEP 7 symbol.

If a tag can no longer be assigned because the address or symbol does not exist, you have the following options:

- Save the association
The tag will be labeled defective. The tag in question must be connected manually.
- Separate tag from symbol
This tag will no longer be compared automatically with the STEP 7 symbol.

20.4 Configuring alarms

20.4.1 Integrating alarms with the alarm numbering procedure

Configuring in SIMATIC STEP 7

ALARM_S and ALARM_D are alarm numbering procedures. Alarm numbers are assigned automatically during STEP 7 configuration. These numbers are used to uniquely assign alarm messages.

During alarm configuration in STEP 7, the stored alarms and attributes are placed in the STEP 7 configuration data. WinCC flexible automatically imports the required data and transfers them later to the HMI device.

You filter the output of ALARM_S alarms WinCC flexible by means of display classes. In the project view select "Alarms ► Settings" and double-click the "Alarm settings". The existing connections are displayed in the "Alarm Procedures" area.

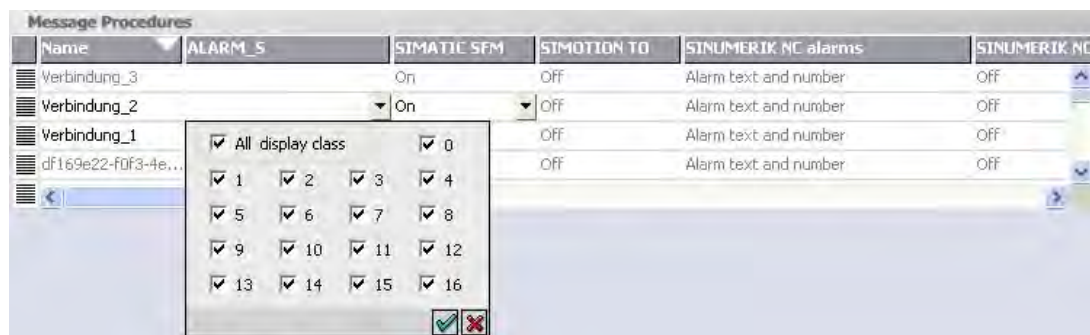

In the row of the required connection, select the field in the "ALARM_S Display Classes" column and open the selection dialog by pressing the selection button. Select the required display class. Close the selection dialog by pressing the button.

In the "SFM Alarms" column of a link, specify whether system errors should be displayed. For more information, consult the STEP 7 documentation.

Maximum number of ALARM_S alarms

The maximum number of ALARM_S alarms in WinCC flexible is 32767. In practice, the maximum number of configurable alarms is limited by the memory available on the HMI device.

Alarm class layout

The ALARM_S and ALARM_D alarms are assigned to particular alarm classes in STEP 7. To edit the display options for these alarm classes, select "Alarms ► Settings ► Alarm Classes" in the WinCC flexible project window. Open the shortcut menu and select the "Open Editor" command. You can recognize alarm classes by the S7 prefix in the alarm class name.

ALARM CLASSES							
Name	Acknowledgment	Log	I color	ID color	IA color	IDA color	
S7Alarm	On "incoming"	<No log>					
S7NoAlarm	Off	<No log>					
S7OperationMessage	Off	<No log>					
S7OperatorInputRequest	Off	<No log>					
S7ProcessControlMaintenance	Off	<No log>					
S7ProcessControlSystemMessageOs	Off	<No log>					
S7ProcessControlSystemMessagePlc	Off	<No log>					
S7ProcessMessageAlarm	On "incoming"	<No log>					
S7ProcessMessageEvent	Off	<No log>					
S7StatUsMessage	On "incoming"	<No log>					
S7Tolerance	Off	<No log>					
S7Warning	Off	<No log>					

You configure the display options for the alarm classes using the "Alarm Classes" editor.

Implementing Alarm_S alarms of SIMOTION

Alarm_S alarms are also available in SIMOTION. Configure the Alarm_S alarms in SIMOTION SCOUT using the "Alarm configuration" editor.

WinCC flexible processes the Alarm_S alarms of SIMOTION similar to Alarm_S alarms of STEP 7.

You filter the output of ALARM_S alarms WinCC flexible by means of display classes. In the project view select "Alarms > Settings" and double-click the "Alarm settings". The existing connections are displayed in the "Alarm Procedures" area.

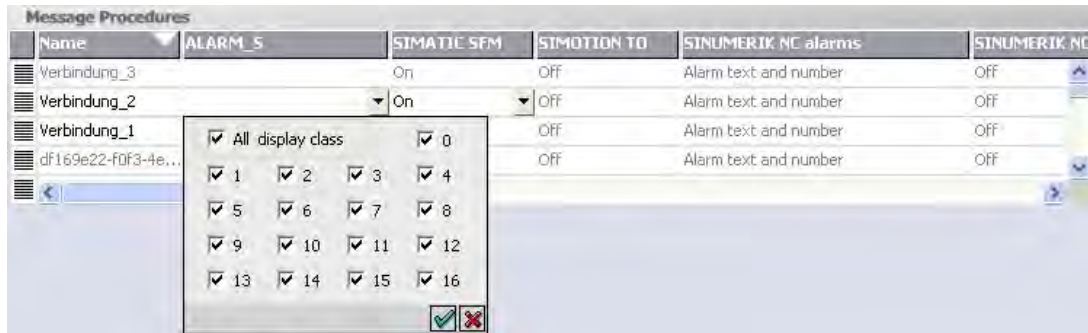

Select the field from the "ALARM_S Display Classes" column and the row which contains the connection to the SIMOTION device. Open the selection dialog box by pressing the selection button. Select the required display class. Close the selection dialog by pressing the button.

Go to the "TO Alarms" column of the connection and define whether to display the process alarms of SIMOTION. For further information, refer to the SIMOTION documentation.

The representation of the alarm classes is configured similar to the alarm classes of Alarm_S alarms of STEP 7.

Appendix

21.1 Open Source Software

Open Source Software

WinCC flexible contains the Open Source Software, among others.

Name	Copyright / Owner of License	
Xerxes	Under Apache Software License, Version 1.1	http://www.apache.org

21.2 Performance features

21.2.1 General Technical Data

21.2.1.1 Released operating systems

Released operating systems

WinCC flexible is released for the following operating systems:

- Windows XP Home SP2, Windows XP Home SP3²⁾
- Windows XP Professional SP2, Windows XP Professional SP3¹⁾
- Windows Vista Business
- Windows Vista Ultimate¹⁾

¹⁾ For multilingual configurations, use the MUI (multilingual user interface) version of the operating system. Visit the Microsoft website at "<http://www.Microsoft.com>".

²⁾ WinCC flexible Micro only.

Note

To find out which version of Windows is installed, select the "General" tab under "Start ► Settings ► Control Panel ► System."

21.2.1.2 Released databases

Released databases

Logging with WinCC flexible Runtime is released for the following databases:

- MS SQL Server: MS SQL Server 2005 Express Edition was tested
- MS Data Engine: MS Data Engine 2000 and MS Data Engine XP were tested

21.2.1.3 Further software versions supported

Further software versions required

WinCC flexible 2008 is ready for operation with the following software:

Software	Version
STEP 7	Version 5.4 SP3
SIMOTION SCOUT	V4.1 SP1
SIMATIC NET	V7.0 (2007)
ProTool	V6.0 SP3
WinCC	V7

21.2.1.4 Recommended printers

Recommended printers

The current list of printers recommended for use with the HMI devices is available on the Internet at:

[Link to the current printer list](#)

Note

All HMI devices except for a PC and Panel PC support only one printer at their USB port, even if several ports are available.

21.2.1.5 Legal characters

Introduction

WinCC flexible supports the full ASCII character set. We advise users, however, to refrain from using localized special characters. You should in particular refrain from using these special characters in the names of objects used in scripts.

Illegal characters

The following characters are not allowed: '

21.2.1.6 Memory requirement of recipes

Introduction

The following calculation of memory requirements of recipes is only valid for Windows CE devices.

Calculation of memory requirements

The memory space required by each recipe (in KB) is derived from the sum of D1 + D2 + D3.

Valid is:

- $D1 = (\text{number of entries} \times 5 + M + 8) : 1024$

Applies to M:

M = Accumulated length of all tag names = sum of characters in all tag names (UTF8 coded, max. 255 bytes per tag name) used in the entries.

- $D2 = [(\text{number of data records} \times 12) + 4] : 1024$
- $D3 = [\text{number of data records} \times (\text{data record length} + N) + 4] : 1024$

Applies to N:

The total length of the name of the corresponding data record in all languages (max. 255 bytes per language) + overhead per data record (1 byte + number of languages * 3 bytes).

D1, D2 and D3 are rounded to the next higher number.

Memory requirements for using arrays

The memory required by each recipe (in KB) is derived from the sum of D1 + D2 + D3.

Valid is:

- $D1 = (\text{number of entries} \times 5 + M + 8) : 1024$

Each element of the tag array used counts as a single entry.

Applies to M:

$M = (\text{length of the array tag name} + K) \times \text{number of array elements}$

Applies to K:

K = 3: 2 to 9 elements in the array

K = 4: 10 to 99 elements in the array

K = 5: 100 to 999 elements in the array

K = 6: 1000 to 9999 elements in the array

K = 7: 10000 to 12000 elements in the array

- $D2 = [(\text{number of data records} \times 12) + 4] : 1024$
- $D3 = [\text{number of data records} \times (\text{data record length} + N) + 4] : 1024$

Applies to N:

The total length of the name of the corresponding data record in all languages (max. 255 bytes per language) + overhead per data record (1 byte + number of languages * 3 bytes).

D1, D2 and D3 are rounded to the next higher number.

Note

If you use both tags and arrays in a recipe, you have to add the results of both formulas to calculate the total memory required.

21.2.1.7 Memory space requirements for recipes of special devices

Introduction

The following calculation of memory requirements of recipes is only valid for the OP 77A and TP 177A devices.

Restrains

The HMI device provides 39 KB of memory space for recipes. This memory space may not be exceeded. The total memory space for recipes is calculated as follows: Total of all recipes + recipe with highest memory requirement.

Each recipe may not exceed a maximum memory space of 19 KB.

Calculation of memory requirements

The memory space requirement of each recipe (in KB) is calculated based on the three addends $D1 + D2 + D3$.

Rule:

- $D1 = \text{number of data records} \times M$

Rule for M (size of a data record):

$M = 1 \times \text{number of elements of a byte} + 2 \times \text{number of elements of 2 bytes} + 4 \times \text{number of elements of 4 bytes} + 8 \times \text{number of elements of 8 bytes} + K$

Rule for K (size of the string elements):

$K = \text{number of string elements} \times (\text{string length} + 1) \times 2$

- D2 - data record size

$D2 = 4 + \text{number of languages} \times 8 + \text{number of languages} \times (4 + 4 \times \text{number of data records} + (\text{length of the data record name} + 1) \times 2 \times \text{number of data records}) + 8 + 8 \times \text{number of data records}$

Or rewritten:

$D2 = 12 + 8 \times \text{number of data records} + \text{number of languages} \times (12 + \text{number of data records} \times (4 + (\text{length of the data record name} + 1) \times 2))$

- D3 - shared memory

$D3 = 14 + \text{number of elements}$

Note

Arrays and single elements can be calculated as described above.

21.2.2 System limits

21.2.2.1 System limits

Introduction

The following tables of system limitations provide assistance in estimating whether a specific project is still within the system limitations of a specific HMI device.

The maximum values specified are not additive, i.e. 4000 alarms can be configured if no further objects are used. However, please note that simultaneous output of 4000 alarms and 300 screens, each with 40 screen objects, is not possible.

In addition to the limitations specified, allowances must be made for restrictions in configuration memory resources.

Engineering System

Configuration in the Engineering System is limited by main memory resources. WinCC flexible requires up to 2 GB of main memory, depending on the operating system.

The configurations shown below have a heavy impact on main memory load:

- high number of animations
- use of faceplates
- use of large graphic objects
- several devices within a project configuration

It is nonetheless useful to install more than 2 GB of RAM on the PC if running many applications with high memory requirements in parallel.

Overview

Micro Panels

	OP 73micro	TP 170micro	TP 177micro
Tags			
Number of tags in the project	500	250	250
Number of PowerTags	--	--	--
Number of elements per array	50	100	100
Number of local tags	--	--	--
Alarms			
Number of alarm classes	32	32	32
Number of discrete alarms	250	500	500
Number of analog alarms	3	--	20
String length of an alarm	80	80	80
Number of process values per alarm	8	8	8
Size of the alarm buffer	100	128	128
Number of queued alarm events	30	16	32

	OP 73micro	TP 170micro	TP 177micro
Screens			
Number of screens	250	250	250
Number of fields per screen	20	20	20
Number of tags per screen	20	20	20
Number of complex objects per screen	5	5	5
Recipes			
Number of recipes	--	--	--
Number of elements per recipe	--	--	--
User data length in bytes per data record	--	--	--
Number of data records per recipe	--	--	--
Number of recipe elements in the project	--	--	--
Reserved memory for data records in the internal Flash	--	--	--
Logs			
Number of logs	--	--	--
Number of entries per log file (including all log segments)	--	--	--
Number of log segments	--	--	--
Cyclical trigger for tag logging	--	--	--
Trends			
Number of trends	--	--	25
Text lists and graphics lists			
Number of graphics lists	--	--	100
Number of text lists	150	--	150
Total number of lists	150	--	150
Number of entries per text or graphics list	30	--	30
Number of graphic objects	250	500	500
Number of text elements	1000	500	500
Scripts			
Number of scripts	--	--	--
Communication			
Number of connections	1	1	1
Number of connections based on the "SIMATIC HMI http Protocol"	--	--	--
Maximum number of connected Sm@rtClients (including a service client)	--	--	--
Help system			
Number of characters in a help text	320	--	320
Languages			
Number of runtime languages	5	5	5
Scheduler			
Tasks	--	--	--

Appendix

21.2 Performance features

	OP 73micro	TP 170micro	TP 177micro
User administration			
User groups	1	1	1
Authorizations	2	2	2
Passwords	1	1	1
Project			
Size of the project file "*.fwx"	128 KB	256 KB	256 KB

Mobile Panels

	Mobile Panel 170	Mobile Panel 177	Mobile Panel 277	Mobile Panel 277 IWLAN	Mobile Panel 277F IWLAN
Tags					
Number of tags in the project	1000	1000	2048	2048	2048
Number of PowerTags	--	-	--	--	--
Number of elements per array	1000	1000	1000	1000	1000
Number of local tags	500	500	1000	1000	1000
Alarms					
Number of discrete alarms	2000	2000	4000	4000	4000
Number of analog alarms	50	50	200	200	200
String length of an alarm	80	80	80	80	80
Number of process values per alarm	8	8	8	8	8
Size of the alarm buffer	256	256	512	512	512
Number of queued alarm events	64	64	250	250	250
Screens					
Number of screens	500	500	500	500	500
Number of fields per screen	50	50	200	200	200
Number of tags per screen	50	50	200	200	200
Number of complex objects per screen	5	5	10	10	10
Recipes					
Number of recipes	100	100	300	300	300
Number of elements per recipe	200	200	1000	1000	1000
User data length in bytes per data record	800	800	4000	4000	4000
Number of data records per recipe	200	200	500	500	500
Number of recipe elements in the project	--	--	--	--	--
Reserved memory for data records in the internal Flash	32 KB	32 KB	64 KB	64 KB	64 KB

	Mobile Panel 170	Mobile Panel 177	Mobile Panel 277	Mobile Panel 277 IWLAN	Mobile Panel 277F IWLAN
Logs					
Number of logs	--	--	20	20	20
Number of entries per log file (including all log segments)	--	--	10000	10000	10000
Number of log segments	--	--	400	400	400
Cyclical trigger for tag logging	--	--	1 s	1 s	1 s
Trends					
Number of trends	50	50	300	300	300
Text lists and graphics lists					
Number of graphics lists	100	100	400	400	400
Number of text lists	300	300	500	500	500
Total number of lists	300	300	500	500	500
Number of entries per text or graphics list	30	30	256	256	256
Number of graphic objects	1000	1000	1000	1000	1000
Number of text elements	2500	2500	10000	10000	10000
Scripts					
Number of scripts	--	--	50	50	50
Communication					
Number of connections	4	4	6	6	6
Number of connections based on the "SIMATIC HMI http Protocol"	--	4	8	8	8
Maximum number of connected Sm@rtClients (including a service client)	--	2	2	2	2
Mobile Wireless					
Number of zones	--	--	--	254	254
Number of effective ranges	--	--	--	--	127
Number of transponders assigned at least 1 zone or 1 effective range	--	--	--	255	255
Number of configurable transponders				65534	65534
Help system					
Number of characters in a help text	320	320	320	320	320
Languages					
Number of runtime languages	5	5	16	16	16
Scheduler					
Tasks	10	10	48	48	48

	Mobile Panel 170	Mobile Panel 177	Mobile Panel 277	Mobile Panel 277 IWLAN	Mobile Panel 277F IWLAN
User administration					
User groups	50	50	50	50	50
Authorizations	32	32	32	32	32
Passwords	50	50	50	50	50
Project					
Size of the project file "*.fwx"	768 KB	2 MB	6 MB	6 MB	6 MB

Basic Panels

	KTP400 Basic	KTP600 Basic	KTP1000 Basic	TP1500 Basic
Tags				
Number of tags in the project	128	128	256	256
Number of PowerTags	--	--	--	--
Number of elements per array	100	100	100	100
Number of local tags	--	--	--	--
Alarms				
Number of alarm classes	32	32	32	32
Number of discrete alarms	200	200	200	200
Number of analog alarms	15	15	15	15
String length of an alarm	80	80	80	80
Number of process values per alarm	8	8	8	8
Size of the alarm buffer	128	128	128	128
Number of queued alarm events	64	64	64	64
Screens				
Number of screens	50	50	50	50
Number of fields per screen	30	30	30	30
Number of tags per screen	30	30	30	30
Number of complex objects per screen	30	30	30	30
Recipes				
Number of recipes	5	5	5	5
Number of elements per recipe	20	20	20	20
User data length in bytes per data record	--	--	--	--
Number of data records per recipe	20	20	20	20
Number of recipe elements in the project	--	--	--	--
Reserved memory for data records in the internal Flash	40 KB	40 KB	40 KB	40 KB

	KTP400 Basic	KTP600 Basic	KTP1000 Basic	TP1500 Basic
Logs				
Number of logs	--	--	--	--
Number of entries per log file (including all log segments) ¹⁾	--	--	--	--
Number of log segments	--	--	--	--
Cyclical trigger for tag logging	--	--	--	--
Number of tags that can be logged ⁴⁾	--	--	--	--
Trends				
Number of trends	25	25	25	25
Text lists and graphics lists				
Number of graphics lists	100	100	100	100
Number of text lists	150	150	150	150
Total number of lists	150	150	150	150
Number of entries per text or graphics list	30	30	30	30
Number of graphic objects	500	500	500	500
Number of text elements	500	500	500	500
Scripts				
Number of scripts	--	--	--	--
Communication				
Number of connections	4	4	4	4
Number of connections based on the "SIMATIC HMI http Protocol"	--	--	--	--
Help system				
Number of characters in a help text	320	320	320	320
Languages				
Number of runtime languages	5	5	5	5
Scheduler				
Tasks	--	--	--	--
User administration				
User groups	50	50	50	50
Authorizations	32	32	32	32
Passwords	50	50	50	50
Project				
Size of the project file "*.fwx"	1024 KB	1024 KB	1024 KB	1024 KB

Appendix

21.2 Performance features

Panels

	OP 73	OP 77A	OP 77B	TP 170A	TP 170B OP 170B	TP 177A	TP 177B OP 177B	TP 270 OP 270	TP 277 OP 277
Tags									
Number of tags in the project	1000	1000	1000	500	1000	500	1000	2048	2048
Number of PowerTags	--	--	--	--	--	--	-	--	--
Number of elements per array	50	100	1000	100	1000	250	1000	1000	1000
Number of local tags	--	--	500	250	500	--	500	1000	1000
Alarms									
Number of alarm classes	32	32	32	32	32	32	32	32	32
Number of discrete alarms	500	1000	1000	1000	2000	1000	2000	4000	4000
Number of analog alarms	3	10	50	--	50	20	50	200	200
String length of an alarm	80	80	80	80	80	80	80	80	80
Number of process values per alarm	8	8	8	8	8	8	8	8	8
Size of the alarm buffer	256	256	256	128	256	256	256	512	512
Number of queued alarm events	16	64	64	16	64	64	64	250	250
Screens									
Number of screens	500	500	500	250	500	250	500	500	500
Number of fields per screen	20	30	30	20	50	30	50	200	200
Number of tags per screen	20	30	30	20	50	30	50	200	200
Number of complex objects per screen	5	5	5	5	5	5	5	10	10

	OP 73	OP 77A	OP 77B	TP 170A	TP 170B OP 170B	TP 177A	TP 177B OP 177B	TP 270 OP 270	TP 277 OP 277
Recipes									
Number of recipes	--	10	100	--	100	10	100	300	300
Number of elements per recipe	--	50	200	--	200	50	200	1000	1000
User data length in bytes per data record	--	800	800	--	800	800	800	4000	4000
Number of data records per recipe	--	20	200	--	200	20	200	500	500
Number of recipe elements in the project	--	--	--	--	--	--	--	--	--
Reserved memory for data records in the internal Flash	--	40 KB	32 KB	--	32 KB	40 KB	32 KB	64 KB	64 KB
Logs									
Number of logs	--	--	--	--	--	--	--	20	20
Number of entries per log file (including all log segments)	--	--	--	--	--	--	--	10000	10000
Number of log segments	--	--	--	--	--	--	--	400	400
Cyclical trigger for tag logging	--	--	--	--	--	--	--	1 s	1 s
Number of tags that can be logged ⁴⁾	--	--	--	--	--	--	--	20	--
Trends									
Number of trends	--	--	--	--	50	25	50	300	300
Text lists and graphics lists									
Number of graphics lists	--	--	--	--	100	--	100	400	400
Number of text lists	150	300	300	--	300	300	300	500	500
Total number of lists	150	300	300	--	300	300	300	500	500
Number of entries per text or graphics list	30	30	30	--	30	30	30	256	256
Number of graphic objects	500	1000	1000	1000	1000	1000	1000	1000	1000
Number of text elements	2500	2500	2500	1000	2500	1000	2500	10000	10000
Scripts									
Number of scripts	--	--	--	--	--	--	--	50	50

Appendix

21.2 Performance features

	OP 73	OP 77A	OP 77B	TP 170A	TP 170B OP 170B	TP 177A	TP 177B OP 177B	TP 270 OP 270	TP 277 OP 277
Communication									
Number of connections	2	4	4	4	4	4	4	6	6
Number of connections based on the "SIMATIC HMI http Protocol"	--	--	--	--	--	--	4	8	8
Maximum number of connected Sm@rtClients (including a service client)	--	--	--	--	--	--	2	6": 3 10": 2	6": 3
Help system									
Number of characters in a help text	320	320	320	--	320	320	320	320	320
Languages									
Number of runtime languages	5	5	5	5	5	5	5	5	16
Scheduler									
Tasks	--	--	10	--	10	--	10	48	48
User administration									
User groups	25	50	50	1	50	50	50	50	50
Authorizations	32	32	32	2	32	32	32	32	32
Passwords	25	50	50	1	50	50	50	50	50
Project									
Size of the project file "*.fwx"	256 KB	256 KB	1 MB	320 KB	768 KB	512 KB	2 MB	2 MB	4 MB

Multi Panels

	MP 177	MP 270B	MP 277	MP 370	MP 377
Tags					
Number of tags in the project	1000	2048	2048	2048	2048
Number of PowerTags	--	--	--	--	--
Number of elements per array	1000	1000	1000	1000	1000
Number of local tags	500	1000	1000	2000	2000
Alarms					
Number of alarm classes	32	32	32	32	32
Number of discrete alarms	2000	4000	4000	4000	4000
Number of analog alarms	50	200	200	200	200
String length of an alarm	80	80	80	80	80
Number of process values per alarm	8	8	8	8	8
Size of the alarm buffer	256	512	512	1024	1024
Number of queued alarm events	64	250	250	500	500

	MP 177	MP 270B	MP 277	MP 370	MP 377
Screens					
Number of screens	500	500	500	500	500
Number of fields per screen	50	200	200	400	400
Number of tags per screen	50	200	200	400	400
Number of complex objects per screen	--	10	10	20	20
Recipes					
Number of recipes	100	300	300	500	500
Number of elements per recipe	200	1000	1000	1000	1000
User data length in bytes per data record	800	4000	4000	4000	4000
Number of data records per recipe	200	500	500	1000	1000
Number of recipe elements in the project	--	--	--	--	--
Reserved memory for data records in the internal Flash	32 KB	64 KB	64 KB	128 KB	128 KB
Logs					
Number of logs	--	20	20	50	50
Number of entries per log file (including all log segments) ¹⁾	--	10000	10000	50000	50000
Number of log segments	--	400	400	400	400
Cyclical trigger for tag logging	--	1 s	1 s	1 s	1 s
Number of tags that can be logged ⁴⁾	--	20	--	50	--
Trends					
Number of trends	50	300	300	400	400
Text lists and graphics lists					
Number of graphics lists	100	400	400	500	500
Number of text lists	300	500	500	500	500
Total number of lists	300	500	500	500	500
Number of entries per text or graphics list	30	256	256	256	256
Number of graphic objects	1000	1000	1000	2000	2000
Number of text elements	2500	10000	10000	30000	30000
Scripts					
Number of scripts	--	50	50	100	100
Communication					
Number of connections	4	6	6	6	6
Number of connections based on the "SIMATIC HMI http Protocol"	4	8	8	8	8
Maximum number of connected Sm@rtClients (including a service client)	2	6": max. 3 10": max. 2	8": max. 3 10": max. 2	12": max. 3 15": max. 2	12": max. 3 15": max. 2 19": max. 1
Help system					
Number of characters in a help text	320	320	320	320	320
Languages					
Number of runtime languages	5	5	16	5	16

	MP 177	MP 270B	MP 277	MP 370	MP 377
Scheduler					
Tasks	10	48	48	48	48
User administration					
User groups	50	50	50	50	50
Authorizations	32	32	32	32	32
Passwords	50	50	50	50	50
Project					
Size of the project file "*.fwx"	2048 KB	4 MB	6 MB	7 MB	12 MB

1) The number of entries for all segmented circular logs is valid for the "segmented circular log" logging method. The product derived from the number of circular logs times the number of data records in this log may not be exceeded.

WinCC flexible Runtime

WinCC flexible Runtime	
Tags	
Number of tags in the project	2048
Number of PowerTags	128 –2048
Number of elements per array	1600
Number of local tags	2000
Alarms	
Number of alarm classes	32
Number of discrete alarms	4000
Number of analog alarms	500
Length of an alarm	80
Number of process values per alarm	8
Size of the alarm buffer	1024
Number of queued alarm events	500
Screens	
Number of screens	500
Number of fields per screen	400
Number of tags per screen	400
Number of complex objects per screen	40
Recipes	
Number of recipes	999
Number of elements per recipe	2000
User data length in bytes per data record	8000
Number of data records per recipe	5000
Number of recipe elements in the project	--
Reserved memory for data records in the internal Flash	--
Logs	
Number of logs	100

WinCC flexible Runtime	
Number of entries per log file (including all log segments) ¹⁾	500000
Number of log segments	400
Cyclical trigger for tag logging	1 s
Number of tags that can be logged ⁴⁾	100
Trends	
Number of trends	800
Text lists and graphics lists	
Number of graphics lists	500
Number of text lists	500
Total number of lists	500
Number of entries per text or graphics list	3500
Number of graphic objects	2000
Number of text elements	30000
Scripts	
Number of scripts	200
Communication	
Number of connections	8
Number of connections based on the "SIMATIC HMI http Protocol"	16
Maximum number of connected Sm@rtClients (including a service client)	5 ³⁾
Help system	
Number of characters in a help text	320
Languages	
Number of runtime languages	16
Scheduler	
Tasks ²⁾	48
User administration	
User groups	50
Authorizations	32
Passwords	100
Project	
Size of the project file "*.fwx"	

¹⁾ The number of entries for all segmented circular logs is valid for the "segmented circular log" logging method. The product derived from the number of circular logs times the number of data records in this log may not be exceeded.

²⁾ Only valid for time-triggered tasks. Event-triggered tasks are not relevant for the system limits.

³⁾ Only up to three Sm@rtClients can interconnect with the Sm@rtServer on Panel PC 477.

⁴⁾ Information for CE devices (TP 270, OP 270, MP 270B, MP 370):

Instead of being designed primarily for cyclic data logging, the HMI devices are rather used to log non-cyclic error states (for example faults and operating alarms). The HMI devices are not designed for complex logging tasks which involve greater data volumes or higher requirements in terms of performance.

Index

"

"Screen Navigation" editor, 159
"Script Wizard", 315

*

*.pwx, 116, 399

A

Accepting tags
 from STEP 7, 431
 STEP 7, 429

Access
 Runtime object model, 323
 Tag, 321

accessing
 Script in the script, 322
 System function in the script, 322

Acknowledge
 Alarm, 183

Acknowledgement tag
 reading, 191
 write, 191

Acquisition cycle
 Tag, 129, 131, 138

Action
 in the Object View, 99

Addressing
 Multiplexing, 134
 Tag, indirect addressing, 134

Alarm
 Acknowledge, 183
 Acknowledging by the PLC, 191
 Basic settings, 198
 Component, 190
 Display on the HMI device, 186
 Editor, 191
 Event, 189
 Logging, 188, 207
 Output, 207
 Printing, 188

 Property, 190
 Reporting, 188, 199, 283
 System alarm, 185
 System function, 188
Alarm class, 184, 202
 Alarm classes editor, 196
Alarm classes editor, 196
Alarm group
 Alarm groups editor, 197
Alarm groups editor, 197
Alarm indicator, 163, 186
Alarm line, 186
Alarm log
 Basic principles, 202
 Displaying alarms, 207
Alarm logging, 202
 Log behavior, 203
 Memory medium, 203
Alarm logs editor, 204
Alarm number, 190
Alarm number procedure, 182
Alarm procedure, 182
Alarm report
 configuring, 284
Alarm status, 182
 Layout, 184
Alarm text, 190
Alarm view, 163, 186
Alarm View
 Filtering, 187
Alarm window, 186
ALARM_D alarm
 configuring in STEP 7, 199, 432
 Configuring in STEP 7, 199, 432
ALARM_S alarm
 configuring in SIMOTION, 201, 434
 configuring in STEP 7, 199, 432
 Configuring in STEP 7, 199, 432
 Filtering a display, 199, 201, 432, 434
Analog alarm
 Analog alarms editor, 194
Analog alarm procedure, 182
Analog alarms editor, 194
Application
 Project documentation, 355

- Recipe view, 250
- Report object, 282
- Application example, 375
 - Entering recipe data offline, 256
 - for reports, 273
 - Recipe with manual production sequence, 257
- Area pointer
 - Connections editor, 216
 - Data record, 235
- Arrange
 - Object in the screen, 167
- Array, 135
 - Indirect addressing, 134
- Array element, 135
- Array tag, 135
- Array transfer from STEP 7, 430
- Asian characters
 - Input on the HMI device, 353
 - Interpretation, 354
 - Memory requirements, 353
- Asian language
 - Configuration, 342
- Asian operating system, 339
- Assigning
 - a function key, 173
- Automatic synchronization, 324
- Automatic translating, 347
- Automation
 - Automatic alarm dispatch, 30
 - Component Based Automation, 32
 - Concept, 26
 - Control with one HMI device, 26
 - Distributed HMI, 31
 - HMI System with centralized functions, 28
 - Mobile units, 29
 - Modular Machine Concept, 32
 - Personal HMI device, 32
 - PLC with several HMI devices, 27
 - Remote access, 29
 - Single-user System, 26

B

- Backing up
 - HMI data, 408
- Bar, 163
- Basic settings
 - Alarm, 198
 - Data log, 266
 - Script, 319
- Behavior
 - Recipe view, 247

- Simple recipe view, 253
- Bootstrapping
 - Operating system, 410
- Branch, 384
- Bulk data processing, 36
 - Advantages, 36
- Button, 163

C

- CBA, 32
- central user administration, 302
- Change, 62
 - A connection, 430, 431
 - Default property, 277
- Change log, 391, 392, 393
- Changing
 - Code formatting in the script, 320
 - Object property, 334
 - Syntax emphasis, 319
- Character set
 - Configurable, 354
 - Regional special characters, 343
- Circle, 163, 281
- Circular log, 203
- Clock, 163
- Collapse, 54
 - Windows, 54
- Combining, 53
 - Windows, 53
- Communication, 363
 - between PLC and tag, 128
 - Ethernet, 217, 220
 - mobile communication, 363
 - using area pointers, 212
 - using tags, 212
- Communication drivers, 213
- Communication partner, 211
- Component Based Automation, 32
- Component parts
 - of a project, 83
- Configuration
 - Move, 37
 - Recipe, 240
 - Tag, 130
- configuring
 - Editing objects simultaneously, 36
 - HMI device-dependent, 34
 - HMI device-independent, 35
 - Movement, 37
 - Movement path, 37
 - PC station, 422

- Screen change, 38
 - solution-oriented concepts, 33
 - target device-dependent, 34
 - target device-independent, 35
- Configuring
 - Asian language, 342
 - Event, 247
 - Toolbar, 45
- Connecting tags
 - Via application points, 431
 - Via the Tag editor, 429
- Connection
 - Changing, 430, 431
- Connection data
 - Format for the import, 147
- Connections editor, 214
- Consistency check
 - Generation, 114
- Consistent configuration, 21
- Control element
 - Logging a change, 397
 - Managing project versions, 386
- Controller
 - Linking tags, 128
- Conversion
 - project integrated in STEP 7, 420, 421
 - The password is changed, 103
- Conversion option
 - Save as version, 101
- Converting a project
 - Displaying alarm classes, 102
 - HMI devices in libraries, 102
 - System requirements after conversion, 102
- Copy
 - flat, 106
 - Overview, 105
- Cover sheet
 - Layout, 356
- Creating
 - Create new project version, 395
 - HMI station, 416
- Cross-reference list, 111
 - Editor, 111
 - Working with, 111
- CSV Export
 - Tags, 145
- csv file
 - Example, 208, 270
 - Layout, 208, 270
- CSV file
 - Project text, 345
 - Tag with address multiplexing, 152

D

- Data
 - Global project, 88
 - HMI device-specific, 88
- Data backup
 - HMI device, 408
- Data exchange, 217
- Data Flow, 227
- Data log
 - Basic settings, 266
 - Editor, 265
 - Output of the tag value, 269
 - Tags, 132, 268
- Data log editor, 265
- Data logging, 261
 - Acquisition cycle, 261
 - Application, 261
 - Logging cycle, 261
 - Memory medium, 262
- Data mailbox
 - For recipes, 235
- Data record list, 243
- Data record name, 239
- Data record number, 239
- Data selection
 - For project report, 360
- Data type
 - External tag, 129
 - Internal tag, 123
- Date/time field, 163, 281
- Debugger
 - Error types, 325
- Default property
 - Changing, 277
- Default value, 70
- Defining a display class
 - for ALARM_S alarms, 199, 201, 432, 434
 - For ALARM_S alarms, 199, 432
- Delta download, 403
- Design
 - Protocol, 274
- Device replacement
 - Device inoperable in runtime, 86
 - DP configuration, 86
- Device-based dependency, 58, 83, 85
 - of screens, 155
 - Principle, 58
- Discrete alarm procedure, 182
- Discrete alarms
 - Discrete alarms editor, 193
- Discrete alarms editor, 193
- Dispatching Alarms

- Automatic, 30
 - via e-mail, 30
- Distributed HMI devices, 31
- Docking, 53
 - Toolbar, 53
 - Windows, 53
- Documentation in WinCC flexible, 113
- Drag-and-drop, 54, 318
- Dynamic control
 - Faceplate, 180
 - Faceplate instance, 180
 - Object included in the faceplate, 180
- Dynamic operation, 172

E

- Eastern characters
 - Input on the HMI device, 353
- Edit objects
 - in SIMATIC Manager, 417
 - In the SIMATIC Manager, 417
- Editing
 - Layout, 357, 358
 - Project, 94
 - Report property, 279
- Editing connections
 - With NetPro, 416
 - With WinCC flexible, 415
- Editing language, 337
- Editing possibilities
 - Project report, 359
- Editor, 62
 - Brief description of the editors, 94
 - Closing, 64
 - Cross-reference list, 111
 - Graphical editor, 60, 95
 - Open, 61
 - Possible WinCC flexible editors, 83
 - Project documentation, 113
 - Properties, 60
 - Screens, 94
 - System dictionary, 348
 - Tabular editor, 60, 94, 191
 - With language-dependent objects, 343
- Editor, 60
- Effective range, 366, 370, 371, 372, 373
 - Overview, 373
 - Runtime, 372
 - Working area, 371
- Effective ranges editor, 370
- Element list, 243
- Ellipse, 163, 281

- Engineering support, 33
 - Overview, 33
- Enhanced recipe view, 243
- Ethernet, 217, 220
- Event, 376, 377
 - Configuring, 247
 - Time-based event, 377
- execute
 - Scripts in runtime, 332
- Export, 304
 - Project text, 346
 - Tags, 145
- Exporting
 - Recipe data record, 230
- External communication
 - With a PC station, 423
- External image file
 - Creating a folder reference, 330
 - managing, 167
- External tag, 321

F

- Faceplate, 110
 - Application, 179
 - Dynamic control, 180
 - Faceplate instance, 179
 - Reusing instances, 179
 - Structure, 139
- Faceplate instance, 179
 - Reusing, 179
- Fault
 - Logical error, 325
 - Runtime error, 325
- Field of application, 363, 375, 381
 - Logging a change, 391
 - Managing project versions, 381
 - Planning jobs, 375
 - User administration, 293
- Filtering
 - of the Alarm View, 187
- Flip
 - Object, 167
- Function
 - Dependency on the type of HMI device, 85
- Function key, 154, 173
- Function list, 312
 - Asynchronous completion, 331
- Function List, 65
 - Completion, 313
 - Completion in runtime, 331
 - configuring, 66

- HMI device dependency, 313
 - Property, 313
 - Script, 313
 - Status information, 313
 - Synchronous completion, 331
 - System function, 313
- Functional scope
 - ProSave, 407
- Functions
 - Updating tag value, 122
- G**
- Gauge, 163
- Generation
 - Consistency check, 114
- Global assignment
 - of a function key, 173
- Global library, 176
- Graphic
 - managing, 169
 - Use from the image browser, 168
 - With transparent background, 169
- Graphic browser
 - Use image, 168
- Graphic IO field, 163
- Graphic IO Field, 281
- Graphic object, 163
- Graphic view, 163
- Graphics editor, 351
- Graphics list, 72, 75
 - Application, 72
 - Configuring, 72
 - Default value, 75
 - Least significant bit set, 75
- Graphics View, 281
- Group, 170
- H**
- Help, 76
 - Displaying, 76
- Help function, 318
- Help indicator, 163
- HMI device
 - configuration with several HMI devices, 83
 - Data backup, 408
 - Inserting multiple, 416
 - Performance features, 440
 - personal, 32
 - Project with several HMI devices, 87
 - Remote access (concept), 29
 - Restoring data, 408
 - Selection, 85
 - synchronized, 31
 - System limits, 440
 - Using a project for several HMI devices, 89
 - Version, 117, 400
- HMI device dependency, 85
 - In the script, 323
 - Principle, 59
- HMI device version, 87, 89
- HMI replacement
 - DP configuration, 86
- HMI station
 - Creating, 416
- HMI system
 - Tasks, 19
- HTML browser, 163
- I**
- Image
 - Structure of editor, 351
- Image version, 87, 89, 117, 400
- Import, 304
 - Project text, 346
 - Recipe data record, 230
- Index tag, 134
- Indirect addressing, 134
- Initializing
 - Password, 403
 - Recipe, 403
- Insert
 - Inserting an object, 167
 - Object, 106
- Installing
 - Audit Viewer, 24
 - Option, 410
- Instance
 - Reusing, 179
- integrated project
 - Log of changes, 417
- Integrated project
 - Change log, 391
 - Log of changes, 411, 417
 - save as version, 420, 421
 - Save as version, 421
 - Symbol server, 425
 - Upload, 118, 404, 411
 - Using HW Config, 415
 - Version management, 411
- Integration in SIMATIC STEP 7, 39
- Integration in SIMOTION SCOUT, 39

- Integration in STEP 7, 413
- IntelliSense, 316
- Internal communication
 - In a PC station, 423
- Internal tag, 321
- Introduction
 - Project documentation, 355
- IO field, 163, 281

- L**
- Language
 - In various editors, 343
- Language dependency
 - System function, 322
- Language support
 - Toolbar, 343
- Language switching, 353
 - In Runtime, 334
 - ProSave, 407
- Language-dependent format, 338
- Layout
 - Cover sheet, 356
 - Editing, 357, 358
 - Project report, 356
 - Property, 357
 - Regional format of the date, time, currency, and numbers, 338
 - Simple recipe view, 252
- Least significant bit set, 71, 75
- Library, 48, 110, 176
 - Global, 49
 - Project-related, 49
 - View in the Toolbox, 176
- Library object, 176
- License
 - for option, 25
 - for WinCC flexible ES, 25
 - for WinCC flexible Runtime, 25
- License Key
 - Transfer to an HMI device, 410
- License key diskette, 410
- License Key storage location, 410
- Licensing
 - order, 26
- Limit range
 - Tag, 130
- Line, 163, 281
- List entry, 69, 73
 - In the graphics list, 73
 - Text list, 69
- Local assignment
 - of a function key, 173
- Local tags, 321
- Log contents
 - Display, 203, 262
- Log database
 - Direct access with ODBC, 209, 271
- Log of changes, 395
 - In integrated project, 391
 - In integrated projects, 411, 417
- Log type, 203
 - Circular log, 262
 - Level-dependent, 262
 - Segmented circular log, 262
- Logging
 - Alarms, 207
 - Basic principles, 202
 - Circular log, 203, 262
 - Log type, 203, 262
 - Segmented circular log, 203, 262
 - Tag value, 261
 - Tags, 132, 268
- Logging a change
 - Control element, 397
 - Field of application, 391
 - Working area, 398
- Logging changes, 391, 396
 - Application, 391
- Logging cycle
 - Tag, 138
- Logical error, 325

- M**
- managing
 - Graphic, 169
- Managing
 - Project version, 381, 385
- Managing project versions, 381
 - Application example, 381
 - Control element, 386
 - Field of application, 381
 - Property view, 388
 - Work area, 387
- Memory requirements
 - Recipe, 437, 438
- Menu, 44
 - Command, 44
- Menu command
 - Simple recipe view, 253
- Migrating
 - WinCC or ProTool projects, 100
- Migration, 58

- Principle, 58
- Mobile Units
 - Use, 29
- Mobile Wireless, 363, 364, 368, 369, 370, 371
 - Field of application, 363
 - How it works, 364
 - Working area, 369, 371
- Modifying recipe structures, 255
- Mouse functions, 55
- Movement path, 37
- Multiple selection, 170
- Multiplexing, 134
- Multi-user project, 84

N

- Navigation, 159
- Navigation arrow, 63
- Navigation control, 162
- navigation structure
 - Specifying, 38
- Navigation Structure, 27
- NetPro
 - Editing connections, 416

O

- Object, 281
 - Access, 323
 - adding ActiveX-Controls, 167
 - Arranging, 167
 - Change property with VBS, 334
 - Creating a new OLE object, 167
 - Creating an OLE object from a file, 167
 - Customizing default properties, 167
 - Flip, 167
 - insert, 167
 - Insert, 106
 - Inserting of the same type, 167
 - Reference, 323
 - Replacing, 107
 - Repositioning and resizing multiple objects, 167, 168
 - Repositioning objects, 167
 - Resizing, 167
 - Rotate, 167
 - Selecting for project report, 361
 - Selecting multiple objects, 167
 - Synchronize in the script, 324
 - Tab order, 167
- Object group
 - Property, 171

- Object list
 - opening, 64
 - Working with, 65
- Object selection
 - Outputting configuration data, 360
- Object view
 - Action in, 99
 - Properties, 51
- Offices, 6
- OLE object
 - create from a file, 167
 - Recreate, 167
- Online
 - Recipe tag, 231, 232
- Online help, 77
 - Displaying, 77
- OP 77A and TP 177A
 - Differences in the recipe, 232
- open
 - Data log editor, 265
- Open, 61
 - Editor, 61
 - Recipes editor, 236
 - Runtime security setting, 300
- opening
 - Opening older project versions, 395
- Operating element
 - Recipe view, 251
- Operating recipes
 - Modifying the recipe structure, 255
- Operating system
 - Asian language setting, 339
 - Setting to Western, 339
 - Updating on HMI device, 409
- Operation
 - Hotkeys, 56
 - Recipe view, 250
 - Simple recipe view, 252
 - With the mouse, 54
- Operation with the keyboard
 - Recipe view, 251
- Operation with the mouse
 - Recipe view, 251
- Operator control
 - Simple recipe view, 252
- Operator control element
 - Editor-specific, 51
 - of a frame, 52
 - of a toolbar, 52
 - Placing editor-specific, 52
- Option, 24
 - Installing, 410
 - Licensing, 25

- organizing
 - Script, 311
- Output
 - Project report, 361
- Output data of a recipe, 287
- Output medium
 - Project report, 355
- Output View, 49
 - Properties, 49
- Overview
 - Report system, 273

- P**
- PageDown, 438
- Parameter
 - Connections editor, 215
- Parameter delivery
 - Script, 323
 - System function, 322
- Password
 - After conversion, 103
 - Initializing, 403
- PC station
 - configuring, 422
 - External communication, 423
 - Internal communication, 423
- Performance features
 - HMI device, 440
- Personal HMI device
 - Use, 32
- Planning jobs, 375, 378
 - Application example, 375
 - Field of application, 375
 - Work area, 379
- Polygon, 163, 281
- Polyline, 163, 281
- Position
 - an object, 167
 - Editing multiple objects, 168
- Print
 - Selection, 360, 361
- Print alarm
 - Configuring output parameters, 284
- Print recipe
 - Configuring output parameters, 288
- Process alarms
 - Activating, 201, 434
- Process screen:
 - Changing, 37
- PROFISafe, 363
- project, 58, 392
 - Functional scope, 59
 - Load, 58
 - Multilingual projects, 92
 - New, 58
 - Several projects, 58
 - Testing with the simulator, 115
 - under version management, 395
 - Working with, 58
- Project, 81
 - Editing, 94
 - HMI device dependency, 83
 - Migrating, 100
 - Multiple HMI devices, 84, 89
 - Rebuild all, 114
- project configuration changes, 392
 - recorded project changes, 392
- Project data, 60
 - Updating, 60
- Project documentation
 - Application, 355
 - Introduction, 355
- Project language, 336
 - Editor, 339
- Project Language editor, 339
- Project library, 110, 176
- Project navigation, 37
- Project report, 355
 - Data selection, 360
 - Editing possibilities, 359
 - For a single object, 360
 - Layout, 356
 - Layout contents page, 357
 - Output, 361
 - Output medium, 355
 - Outputting Compact, 357
 - Outputting Complete, 357
 - Selecting objects, 361
- Project session, 393
- Project tag, 321
- Project text
 - Access to, 344
 - Editor, 344
 - Translating externally, 345
- Project Texts editor, 344
- Project version, 381, 383, 395
 - current version, 388
 - Managing, 385
 - New project version, 395
 - next version, 388
 - Older project versions, 383, 395
- Project view
 - Working with, 47
- Project View, 46

- HMI device dependent data, 87
 - Selection of HMI device types, 85
 - Property
 - Alarm, 190
 - Function List, 313
 - Layout, 357
 - Tag, 127
 - Property view, 47
 - Property, 47
 - Tag, 126
 - ProSave, 407
 - Language switching, 407
 - Protocol
 - Application example, 273
 - Design, 274
 - ProTool project
 - Migrating, 100
- Q**
- Quick start
 - of WinCC flexible, 79
- R**
- Read continuously
 - Tag, 131
 - Rebuild all
 - Project, 114
 - Recipe, 223, 225
 - Application example: Machine parameter assignment, 224
 - Application example:Batch production, 224
 - Basic principles, 223
 - Basics, 225
 - Configuration, 240
 - Configuration option, 230
 - Data Flow, 227
 - Data record, 225
 - Differences in TP 177A and OP 77A, 232
 - Display, 224
 - Entry, 225
 - Initializing during transfer, 403
 - Memory requirements, 437, 438
 - Output data for reporting, 287
 - Recipe screen, 242
 - Recipe view, 242
 - Setting, 240
 - Tags, 233
 - Transfer, 404
 - Use, 224
 - Using text lists, 238
 - Recipe data
 - loading and saving, 228
 - Overwrite during transfer, 403
 - Recipe data record
 - Importing and exporting, 230
 - Transfer option, 227
 - Using text lists, 238
 - Recipe data record name, 239
 - Writing to a tag, 245
 - Recipe data record number, 239
 - Writing to a tag, 245
 - Recipe list, 243
 - Recipe name
 - Writing to a tag, 245
 - Recipe number
 - Writing to a tag, 245
 - Recipe report
 - configuring, 288
 - Recipe screen
 - Recipe tag, 226
 - Synchronize tags, 249
 - Visual machine simulation, 248
 - Recipe setting, 240
 - Recipe tag
 - Online, 232
 - Synchronizing, 231
 - Recipe view, 163, 242, 250
 - Application, 250
 - Behavior, 247
 - Behavior with screen change, 247
 - Configurable events, 247
 - Displaying values only, 244
 - Expanded, 243
 - Operating element, 251
 - Operation, 250
 - Operation using the function key, 247
 - Operation with the keyboard, 251
 - Operation with the mouse, 251
 - Recipe data record, 226, 247
 - Simple, 243
 - Updating, 243
 - Using as a drop-down list, 246
 - Recipes editor, 239
 - Data records, 239
 - Elements tab, 237
 - Work area, 236
 - Rectangle, 163, 281
 - Recursion level, 308
 - Reference
 - Object, 323
 - Reference language, 337
 - Reference text function, 343
 - Remote access, 29

- Application possibilities, 30
- Replacing, 112
 - Character string, 112
 - Object, 112
- Report object
 - Application, 282
- Report property
 - Editing, 279
- Report system, 273
 - Overview, 273
- Representatives, 6
- Restoring
 - HMI data, 408
- Restoring data
 - HMI device, 408
- Return value, 333
- Reuse
 - Library, 36
 - Text library, 36
- Reusing
 - Faceplate, 179
- Rewire, 112
- Rotate
 - Object, 167
- Routing connection, 424
 - Creating, 424
 - for the transfer, 426
- Runtime, 372
 - Change object property with VBS, 334
 - Completion of the function list, 331
 - Effective range, 372
 - Language switching, 334
 - processing scripts, 332
 - Scripting, 307
 - Task, 23
 - User administration, 293
- Runtime error, 325
- Runtime language, 337, 352
- Runtime scripting, 308
- Runtime security setting
 - Editor, 300
 - Exporting the user administration, 301
 - Open, 300
 - Structure, 300
- Runtime security settings editor, 300

S

- S7 Ethernet
 - Transfer, 402
- Safety instruction
 - Recipe data record in background, 243

- save as version
 - project integrated in STEP 7, 420
- Save as version
 - Conversion option, 101
 - project integrated in STEP 7, 421
 - Version overview, 101
- Scalability, 34
- scaling
 - Linear Scaling, 129
- Scaling
 - Tag, linear scaling, 133
- Scheduler, 375
- Screen
 - Device-based dependency, 155
 - Font, 156
 - Working steps in creating, 158
- Screen Editor, 157
- Screen navigation, 37
- Screen Navigation
 - Work area, 160
- Script, 308, 310
 - Application, 311
 - Basic settings, 319
 - Call up in the script, 322
 - Change code formatting, 320
 - Help function, 318
 - HMI device dependency, 323
 - In function list, 313
 - In the script, 322
 - organizing, 311
 - Parameter delivery, 323
 - Particularity when calling up, 323
 - processing in runtime, 332
 - Properties, 310
 - Recursion level, 308
 - Return value, 333
 - Updating tag value, 122
 - Use system function, 334
- Script editor, 314
 - Changing syntax emphasis, 319
 - Edit the settings., 319
 - Properties, 316
 - Work area, 315
- Script editor, 314
- search, 112
 - Character string, 112
 - Object, 112
- Segmented circular log, 203
- Selecting
 - Multiple objects, 167
 - Objects for project report, 361
- Selection
 - Print, 360, 361

- Sequence, 377
 - Task, 377
- Setting
 - Alarm, 198
 - For transferring, 401
 - Languages in the operating system, 338
 - Recipe, 240
- shared library, 110
- Shortcut menu
 - accessing, 55
- Signal, 181
 - Basic principles, 181
- Significance, 71, 75
- SIMATIC HMI
 - Definition, 19
 - Introduction, 19
 - Tasks, 19
 - WinCC flexible, 20
- SIMATIC Logon, 302
- SIMATIC Manager
 - Editing WinCC flexible objects, 417
 - Working with, 414
- SIMATIC STEP 7, 90
- SIMOTION
 - Alarm_S alarms, 201, 434
 - Process alarms, 201, 434
- SIMOTION SCOUT, 90
- simple copying, 106
- Simple objects, 281
- Simple recipe view, 243
 - Behavior, 253
 - Control object, 252
 - Layout, 252
 - Menu command, 253
 - Operation, 252
- Simulation, 115
- Single-user project, 84
- Size
 - An object, 167
 - Editing multiple objects, 168
- Slider, 163
- SmartClient display, 163
- Softbus
 - configuring, 423
- Special characters, 343
- Specifying
 - Properties of object groups, 171
- Standard layout, 357
- start, 61
- Start
 - WinCC flexible, 79
- Start Center
 - Disable, 79
 - Menu command, 78
- Start value
 - Tag, 131
- starting
 - Editor, 61
- Starting WinCC flexible
 - Write permissions required, 79
- Status force, 163
- Status information
 - Function List, 313
- STEP 7
 - Accepting tags in WinCC flexible, 429, 431
 - Activating tags in WinCC flexible, 429
 - Array transfer to WinCC flexible, 430
- STEP 7 integration
 - Advantages, 413
 - Requirements, 413
- Structure, 139, 294
 - Copy, 142
 - Deleting, 142
 - Faceplate, 139
 - Inserting, 142
 - rename, 142
 - Runtime security setting, 300
 - Tags, 139
 - User Administration, 294
- Structure element
 - Copy, 143
 - Deleting, 143
 - Editing, 143
 - Inserting, 143
 - Rename, 142
 - Tag, 139
- Structures Editor
 - Work area, 141
- Switch, 163
- Symbol library, 163
- Symbol server
 - Integrated project, 425
- Symbolic IO field, 163, 281
- Synchronization
 - Manual, 324
 - Recipe view and recipe screen, 227
 - With PLC, 235
- Synchronize tags
 - in the recipe view, 249
- synchronizing
 - Of objects in the script, 324
 - Of tags in the script, 324
- Synchronizing
 - Recipe tag, 231
- Syntax emphasis, 317
 - Changing, 319

- System alarm, 185
 - System Alarms editor, 195
- System Alarms editor, 195
- System dictionary, 347
 - Editor, 348
 - Structure of editor, 348
- System dictionary editor, 348
- System function, 307, 308
 - Application, 309, 310
 - Call up in the script, 322
 - In function list, 310, 313
 - in script, 310
 - In the script, 322, 334
 - Language dependency, 309, 322
 - Parameter delivery, 322
 - Particularity when calling up, 322
 - Use, 310
- System limits, 440
 - HMI device, 440

T

- Tab, 63
- tag
 - Internal tag, 123
- Tag
 - Access with VBS, 321
 - Acquisition cycle, 129, 131, 138
 - Array, 135
 - Communication with a PLC, 128
 - Configuration, 130
 - Data log, 132, 268
 - Exporting, 144
 - External tag, 121, 122
 - Importing, 144
 - Index tag, 134
 - Indirect addressing, 134
 - Limit range, 130
 - linear scaling, 133
 - Linear Scaling, 129
 - Local, 321
 - Logging, 132, 268
 - Logging cycle, 138
 - Multiplexing, 134
 - Property, 127
 - Property view, 126
 - Read continuously, 131
 - Start value, 131
 - Structure, 139
 - Structure element, 139
 - Synchronize in the script, 324
 - Tolerance band, 132, 268

- Tag activation
 - STEP 7, 429
- Tag connection
 - Using the Tag editor, 429
- Tag data
 - Format for the import, 149
- Tag editor, 124
 - Work area, 194, 195, 196, 197, 204, 265, 349
- Tag import
 - Data structure of connection data, 147
 - Format of tag data, 149
 - Procedure, 144
- Tag list
 - Indirect addressing, 134
- Tag value
 - Output, 269
- Tag with address multiplexing
 - Importing, 152
- Tags
 - CSV Export, 145
 - Export, 145
 - OP 77A, 233
 - TP 177A, 233
- Task, 376
 - Sequence, 377
- Text entry, 69
 - Text list, 69
- Text field, 163
- Text Field, 281
- Text list, 67
 - Application, 67
- Text list
 - Configuring, 68
- Text list, 68
- Text list
 - Default value, 70
- Text list, 70
- Text list
 - Least significant bit set, 71
- Text list, 71
- Text lists
 - Using recipe data records, 238
- TIA, 32, 39
- Timer, 375, 377
- Toggle, 62
 - Between Runtime languages, 353
- Tolerance band
 - Tags, 132, 268
- Toolbar, 45, 53
 - Configuring, 45
 - Docking, 53
 - Language support, 343
 - Order, 167

- Positioning, 44
- Toolbox, 157
 - Write-protected libraries, 176
- Tooltip, 76
- Totally Integrated Automation, 32, 39
 - SIMATIC STEP 7, 39
 - SIMOTION SCOUT, 39
- Training center, 7
- Transfer
 - *.pwx, 116, 399
 - Basic principles, 116, 399
 - Delta download, 403
 - Do not transfer object names, 320
 - Method, 401
 - OP 73, 402
 - OP 73micro, 402
 - OP 77A, 402
 - over routing connection, 426
 - Overwrite recipe data, 403
 - Recipe, 404
 - Remove comment from script, 320
 - S7 Ethernet, 402
 - TP 177A, 402
 - TP 177micro, 402
 - Transfer settings, 401
 - Upload, 403
 - via USB, 404
- Transfer mode
 - On the HMI device, 117, 400
- Transfer via USB, 401
- Transferring
 - License key on HMI device, 410
- Transferring recipe values
 - between HMI device and PLC, 229
- Translate
 - Automatic, 347
 - Editors, 335
 - Workflow, 341
- Translation
 - Translating project text externally, 345
- Transparency
 - In graphic, 169
- Transponder, 366
- Trend, 263
- Trend view, 163, 263
- Trunk, 383

U

- Uninstalling
 - User dictionary, 347
- Update cycle, 138

- Updating
 - Operating system on the HMI device, 409
- Upload
 - From HMI device, 118, 404
 - Integrated project, 118, 404, 411
 - Project file, 403
- USB
 - Transfer, 401, 404
- Use, 224
 - Faceplate, 35
 - Of recipes, 224
 - Script, 311
 - System function, 310
- User administration, 293, 295, 296
 - central user administration, 302
 - Field of application, 293
 - Purpose, 293
 - SIMATIC Logon, 302
 - Work area, 298, 299
- User Administration, 293, 294
 - Structure, 294
- User data, 304
 - Export, 304
 - Import, 304
- User dictionary, 347
 - Editor, 349
 - Structure of editor, 349
 - Uninstalling, 347
- User dictionary editor, 349
- User interface language, 336
 - WinCC flexible, 389
- User password
 - Changed after conversion, 103
- User rights
 - at the initial start of WinCC flexible, 79
- User view, 163, 304, 305
- User-dependency
 - Working environment, 77
- Using HW Config
 - In integrated project, 415

V

- VBS
 - Change object properties, 334
 - Help function, 318
- Version
 - HMI device, 117, 400
- version comparison, 389
- Version management, 381
 - in integrated projects, 411

W

- WinCC flexible, 20
 - Application, 20
 - Automation concept, 26
 - Consistent configuration, 21
 - Customizing the user interface, 35
 - Editing connections, 415
 - Edition, 57
 - Engineering support, 33
 - Engineering System, 22
 - Individual configuration, 77
 - Multilingual user interfaces, 92
 - Options, 20
 - Quick start, 79
 - Runtime software, 23
 - Start, 79
 - User Interface, 42
 - without licensing, 26
 - Working with, 57
- WinCC flexible, 42
- WinCC project
 - Migrating, 100
- Windows, 53
 - Collapse, 54
 - Combining, 53
 - Docking, 53
- Wireless, 363
- Wireless network, 363
- WLAN, 363
- WLAN area, 365
- Work area, 45
 - Effective range, 371
 - Managing project versions, 387
 - of the screen editor, 157
 - Planning jobs, 379

- Screen Navigation, 160
- Script editor, 315
- Structures Editor, 141
- Tag editor, 125, 193, 194, 195, 196, 197, 204, 265, 348, 349
- User administration, 298, 299
- working
 - in the Object View, 99
 - with cross-reference list, 111
 - with projects, 81
- Working area, 371
 - Logging a change, 398
 - Mobile Wireless, 369, 371
 - Zone, 369
- Working environment
 - resetting, 77
 - User-dependency, 77
- Working step, 60
 - Restoring, 60
 - to create screens, 158
 - Undo, 60
- Write permissions
 - for the initial start of WinCC flexible, 79

X

- XLS file
 - Project text, 345

Z

- Zone, 365, 368
 - Working area, 369
- Zones editor, 368