

SIEMENS

SIMATIC

COM PROFIBUS

Manual

This manual is part of the
COM PROFIBUS CD-ROM
(order no. **6ES5 895-6SE03**)

Preface, Contents

Product overview

1

Installation and uninstallation

2

User interface

3

PROFIBUS-DP
configuration example

4

PROFIBUS-FMS
configuration example

5

Running PROFIBUS-DP and
PROFIBUS-FMS in parallel

6

Importing configurations

7

Exporting configurations

8

Device master files

9

Assigning shared input
masters

10

Taking into account other
masters that are not contained
in COM PROFIBUS

11

Tips and tricks

12

Glossary, Index

Edition 03/2001

EWA 4NEB 780 6035-02 02

Safety Guidelines

This manual contains notices which you should observe to ensure your own personal safety, as well as to protect the product and connected equipment. These notices are highlighted in the manual by a warning triangle and are marked as follows according to the level of danger:



Danger

indicates that death, severe personal injury or substantial property damage **will** result if proper precautions are not taken.



Warning

indicates that death, severe personal injury or substantial property damage **can** result if proper precautions are not taken.



Caution

indicates that minor personal injury or property damage can result if proper precautions are not taken.

Note

draws your attention to particularly important information on the product, handling the product, or to a particular part of the documentation.

Qualified Personnel

Only **qualified personnel** should be allowed to install and work on this equipment. Qualified persons are defined as persons who are authorized to commission, to ground, and to tag circuits, equipment, and systems in accordance with established safety practices and standards.

Correct Usage

Note the following:



Warning

This device and its components may only be used for the applications described in the catalog or the technical description, and only in connection with devices or components from other manufacturers which have been approved or recommended by Siemens.

This product can only function correctly and safely if it is transported, stored, set up, and installed correctly, and operated and maintained as recommended.

Trademark

SIMATIC®, SIMATIC HMI® and SIMATIC NET® are registered trademarks of SIEMENS AG.

Third parties using for their own purposes any other names in this document which refer to trade-marks might infringe upon the rights of the trademark owners.

Copyright © Siemens AG 1999 All rights reserved

The reproduction, transmission or use of this document or its contents is not permitted without express written authority. Offenders will be liable for damages. All rights, including rights created by patent grant or registration of a utility model or design, are reserved.

Siemens AG
Automation Group
Industrial Automation Systems
P.O. Box 4848, D-90327 Nuremberg

Disclaimer of Liability

We have checked the contents of this manual for agreement with the hardware and software described. Since deviations cannot be precluded entirely, we cannot guarantee full agreement. However, the data in this manual are reviewed regularly and any necessary corrections included in subsequent editions. Suggestions for improvement are welcomed.

©Siemens AG 1999
Technical data subject to change.

Preface

Purpose of the manual

The information in this manual tells you how to install COM PROFIBUS and carry out complete configurations with COM PROFIBUS.

We use two full configuration examples to illustrate how to work with COM PROFIBUS. These contain all the important functions of COM PROFIBUS and can be easily followed:

- PROFIBUS-DP configuration example
- PROFIBUS-FMS configuration example

Target audience

This manual is aimed at those who use COM PROFIBUS for planning, commissioning and diagnostics with PROFIBUS-DP and PROFIBUS-FMS bus systems based on the EN 50170, Volume 2, PROFIBUS standard.

You will find product-specific configuration information on your PROFIBUS devices in the product documentation.

Scope of validity

This manual is valid for **COM PROFIBUS as of V 5.0**.

It contains a description of the product's functions that was correct at the time of going to press. We reserve the right to describe new functions or changes in an accompanying product information document.

Online help system

All the information you will need is offered in an online help system in COM PROFIBUS. This contains full descriptions of all the functions of COM PROFIBUS. In addition, you can also request context-sensitive information on any open dialog box.

Aids to accessing information

In order to facilitate rapid access to specific information, the manual contains the following aids:

- A complete table of contents at the beginning of the manual
- A glossary after the appendices, in which important technical terms used in the manual are defined
- A thorough index at the end of the manual, which quickly enables you to find the information you require

Further support

If you have any questions of a technical nature, please get in touch with your contact at the Siemens representative or office assigned to you. You will find the address in the manuals for the Siemens DP masters - for example, in the "Siemens Worldwide" appendix of the manual S7-300 Programmable Controller; Hardware and Installation, in catalogs and on CompuServe (GO AUTFORUM).

If you require device master files, you can obtain them as follows:

- By direct modem link on +49 (911) 737972
- On the Internet at http://www.ad.siemens.de/csi_e/gsd

Constantly updated information

You can obtain constantly updated information on SIMATIC products:

- On the Internet at <http://www.ad.siemens.de/simatic>
- By calling the fax polling number +49 8765-93 00 50 00

In addition, SIMATIC Customer Support provides you with current information and downloads that can be of use to you with your SIMATIC products:

- On the Internet at <http://www.ad.siemens.de/simatic-cs>
- At the SIMATIC Customer Support Mailbox on +49 (911) 895-7100

To access the mailbox, use a V.34 (28.8 kbps) modem and set the following parameters: 8, N, 1, ANSI. Alternatively, use ISDN (x.75, 64 kbps).

You can contact SIMATIC Customer Support by phone on +49 (911) 895-7000 and by fax on +49 (911) 895-7002. You can also send inquiries by e-mail on the Internet or to the above mailbox.

Contents

	Preface	
	Contents	
1	Product overview	
2	Installation and uninstallation	
3	User interface	
4	PROFIBUS-DP configuration example	
4.1	Starting configuration.....	20
4.2	Setting up the bus configuration.....	21
4.3	Entering bus parameters	22
4.4	Entering master parameters.....	24
4.5	Entering host parameters	26
4.6	Entering slave parameters for the ET 200B	27
4.7	Entering slave parameters for the ET 200M.....	31
4.8	Entering slave parameters for the ET 200S	36
4.9	Entering slave parameters for the IM 308-C DP slave.....	42
4.10	Assigning groups	46
4.11	Saving the configuration	47
4.12	Documenting and printing the configuration.....	47
4.13	Commissioning the programming device/PC online on the bus.....	48
4.14	Transferring (exporting) the configuration to the DP master	49
4.15	Assigning a PROFIBUS address.....	51
4.16	Testing the signal states of the individual DP slaves	52
4.17	Commissioning the bus configuration	53
4.18	Evaluating a diagnosis with COM PROFIBUS	54
5	PROFIBUS-FMS configuration example	
5.1	Starting configuration.....	58
5.2	Setting up the bus configuration.....	59
5.3	Entering bus parameters	60
5.4	Entering master parameters.....	62
5.5	Entering station parameters for the S7-300 CP 343-5 FMS	65

5.6	Setting FMS connections to the S7-300 CP 343-5 FMS.....	65
5.7	Entering station parameters for the ET 200U DP/FMS	72
5.8	Setting FMS connections to the ET 200U DP/FMS.....	73
5.9	Saving the configuration	78
5.10	Documenting and printing the configuration.....	78
5.11	Transferring (exporting) the configuration to an NCM file	79
6	Runing PROFIBUS-DP and PROFIBUS-FMS in parallel	
7	Importing configurations	
8	Exporting configurations	
9	Device master files	
10	Assigning shared input masters	
11	Taking into account other masters that are not contained in COM PROFIBUS	
12	Tips and tricks	
	Glossary	
	Index	

1 Product overview

What is COM PROFIBUS?

The COM PROFIBUS configuration software makes it easy to configure and commission PROFIBUS-DP and PROFIBUS-FMS bus systems.

COM PROFIBUS runs under MS Windows 9x/NT and offers you a graphical user interface that allows you to:

- Configure masters and slaves easily
- Set transmission rates for the PROFIBUS bus system
- Transfer (export) the data directly to the master via the PROFIBUS bus system
- Commission the PROFIBUS bus system with the aid of diagnostic functions
- Display the status of inputs and outputs and set defined outputs
- Document the configuration in detail

Configuration with COM PROFIBUS

COM PROFIBUS is installed on the programming device/PC.

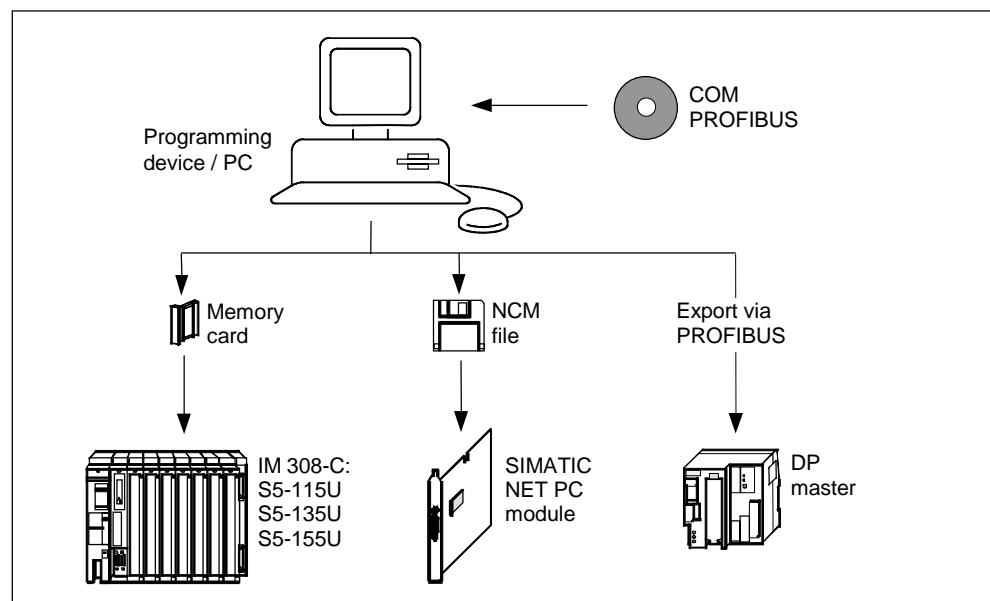

Figure 1-1 Configuration with COM PROFIBUS

Configurable DP masters

- The S5-115U, S5-135U or S5-155U with the IM 308-C as a DP master (up to 12 Mbps)
- The S5-95U with a DP master interface (up to 1.5 Mbps)
- The SIMATIC NET PC module CP 5412 (A2) as a DP master
- Communication modules for connecting the SIMADYN D control system
- The TELEPERM M programmable controllers AS 388 TM/488 TM
- The SIMATIC TI505-FIM field interface module for connecting the SIMATIC TI505
- The PROFIBUS-DP IM 180 master interface module
- The SIMATIC NET PC modules CP 5511, CP 5611, CP 5611 Onboard (in the PG 7x0 PII) and CP 5411 as DP masters

Configurable DP slaves

- ET 200 distributed I/O devices: the ET 200B, ET 200C, ET 200L, ET 200M, ET 200S and ET 200X (up to 12 Mbps) and the ET 200U, ET 200L (up to 1.5 Mbps)
- The S5-115U, S5-135U or S5-155U with the IM 308-C as a DP slave (up to 12 Mbps)
- The S5-95U with a DP slave interface (up to 1.5 Mbps)
- DP/AS-I Link as the interface to the actuator/sensor interface
- The S7-200 with the CPU 215-2 DP or CP 242-8 as a DP slave
- The S7-300 with the CPU 315-2 DP or CP 342-5 as a DP slave
- The S7-400 with the CP 443-5 as a DP slave
- Communication modules for connecting:
 - SIMOVERT master drives
 - SIMOREG converters
 - The SIMADYN D control system
 - SIMOCODE-DP low-voltage switchgear
 - Text displays and operator panels for machine-oriented operation/monitoring
 - MOBY identification systems
 - The SIMODRIVE sensor - absolute value sensor with PROFIBUS-DP connection
 - SIPOS electric actuators
 - SIPART industrial/process controllers
- The PROFIBUS-DP RBC interface module for connecting the SIMATIC TI505

Configurable FMS masters

- The SIMATIC NET PC module CP 5412 (A2) as an FMS master

Configurable FMS stations

- The ET 200U DP/FMS distributed I/O device
- SIMOCODE FMS low-voltage switchgear
- The SIMATIC NET PC module CP 5412 (A2) as an FMS station
- The CP 5431 FMS communication processor
- The S7-300 with the CP 343-5 as an FMS station
- The S7-400 with the CP 443-5 as an FMS station

Field devices of other vendors

COM PROFIBUS also allows you to parameterize the field devices of other vendors. Device master files are generally supplied with the field devices. These can be integrated in configuration tools and permit easy and user-friendly parameterization. COM PROFIBUS can interpret these device master files provided the files are created in accordance with the EN 50170, Volume 2, PROFIBUS standard.

Configuring ET 200 devices for DP masters of other vendors

When ET 200 devices are connected to DP masters that are not parameterized with COM PROFIBUS (DP masters of other vendors), a device master file with predefined settings can be created with COM PROFIBUS in accordance with the EN 50170, Volume 2, PROFIBUS standard.

This device master file is then loaded in the other vendor's configuration software and can be used to parameterize the ET 200 device with ease. The user-friendly plain-text parameterization of COM PROFIBUS is used. Hexadecimal code entries in the configuration software of the other vendor are not required.

Device master files for COM PROFIBUS

A device master file is required for every PROFIBUS device configured with COM PROFIBUS.

Device master files for the above PROFIBUS devices (DP and FMS) are supplied with COM PROFIBUS. The device master files of new Siemens I/O devices whose device master files are not in COM PROFIBUS's GSD directory are available from the interface center. You can download them by modem on:

- Tel. +49 (911) 737972
- Tel. +49 (911) 730983

Alternatively, you can download the device master files for SIEMENS devices on the Internet. You will find all the device master files under "Downloads" on the SIMATIC Customer Support Web page at http://www.ad.siemens.de/csi_e/gsd.

Online help system

You can access all the information you need in the COM PROFIBUS online help system. You call the help system by choosing the **Help > Help topics** menu command in COM PROFIBUS.

COM PROFIBUS manual (electronic manual)

This COM PROFIBUS manual is provided in PDF format. It contains information for those new to COM PROFIBUS and includes complete configuration examples.

What is described where?

The table below tells you where to find what in the COM PROFIBUS documentation.

Table 1-1 Where to find what information on COM PROFIBUS

Information	COM PROFIBUS manual	Online help system
Area of application and prerequisites	x	x
Installation and startup	x	x
Elements of the user interface, structure of the editing window	x	x
Examples: <ul style="list-style-type: none"> • Complete DP configuration example • Complete FMS configuration example 	x	
Operating instructions (step-by-step instructions for all COM PROFIBUS functions)		x
Information on: <ul style="list-style-type: none"> • Dialog boxes • Menu commands • User interface elements 		x

2 Installation and uninstallation

Requirements for working with COM PROFIBUS

COM PROFIBUS runs under the MS Windows operating system. We assume that you are familiar with MS Windows.

Requirements for running COM PROFIBUS

In order to run COM PROFIBUS without limitations, you need:

- An MS Windows 9x/NT operating system
- At least 32 MB free RAM
- Approx. 16 MB free hard disk space
- At least a 486 processor

Terms of the license agreement

See the software license agreement in the COM PROFIBUS setup procedure.

Readme file

Note

Read the constantly updated information on the installation, online operation and functions of COM PROFIBUS in the README.WRI file.

To open the README.WRI file, do one of the following things:

- Double-click README.WRI on the COM PROFIBUS CD-ROM.
- Specify that it should be opened automatically once the installation of COM PROFIBUS is completed.
- From the Windows **Start menu, choose:**
`Start > Programs > Siemens COM PROFIBUS > View Latest
Readme Information`

Scope of the delivery package

The following are available on the COM PROFIBUS CD-ROM in German, English, French, Spanish and Italian:

- The COM PROFIBUS configuration software
- Drivers for the "Set PG/PC interface" and "Parameterize memory card" functions (SIMATIC device drivers)
- A readme file with important information on COM PROFIBUS
- The *COM PROFIBUS* manual (PDF)
- *ET 200 Distributed I/O System* manual
- Acrobat Reader V 3.01 for viewing the manuals and installation instructions in PDF format

Online operation of the PC/programming device

COM PROFIBUS allows you to run your PC or programming device online on the PROFIBUS bus system. This means that the PC/programming device takes part in the data traffic on the PROFIBUS system as an active node.

You need online operation for the DP online functions of COM PROFIBUS (e.g. the diagnostic functions) or for the direct transfer of the configuration data to the DP master via the PROFIBUS bus system.

Requirements for online operation

For online operation you need one of the following PROFIBUS cards for the PC/programming device:

- CP5411 card
- CP5511 card (PCMCIA)
- CP5611 card (PCI)
- CP5611 Onboard (for the PG 7X0 PII)
- CP5412 A2
- MPI ISA card
- Integrated MPI/PROFIBUS interface (only for Siemens programming devices)

Note

Note that under COM PROFIBUS the MPI cards (MPI ISA card, integrated MPI/PROFIBUS interface) can only be run up to a transmission rate of 1500 kbps.

Installing COM PROFIBUS

If the CD-ROM drive's AutoPlay function is switched on, proceed as follows:

1. Insert the COM PROFIBUS CD-ROM in the CD-ROM drive of your programming device/PC. Windows 9x/NT automatically looks for the setup.exe installation program.

If the CD-ROM drive's AutoPlay function is switched off, proceed as follows:

1. Start the Windows 9x/NT dialog for installing software by double-clicking the "Add/Remove Programs" icon in "Control Panel".
2. Click "Install".
3. Insert the COM PROFIBUS CD-ROM in the CD-ROM drive of your programming device/PC, and then click "Next". Windows 9x/NT looks for the setup.exe installation program.

The program takes you step by step through the installation process. During the installation process you are asked questions and offered options to select in dialog boxes. Please also read the paragraphs that follow in order to be able to work through the dialogs more quickly.

Result: On completion of installation, a program group is created for COM PROFIBUS:

```
Start > Programs > Siemens COM PROFIBUS > ...
```

On installing the manuals

At the beginning of the installation process you can decide whether you want the manuals supplied on the CD-ROM in PDF format to be copied onto your computer.

If you do not have access to Acrobat Reader on your computer, please select the option for installing Acrobat Reader.

After installation the manuals can be opened from the Windows Start menu:

```
Start > Programs > Siemens COM PROFIBUS > COM PROFIBUS manual  
...
```

On memory card parameterization

During installation, a program for parameterizing the memory card is also installed.

After installing COM PROFIBUS, you can start this program as follows from the Windows Start menu:

```
Start > Programs > Siemens COM PROFIBUS > Memory Card  
Parameter Assignment
```

Possible settings:

- If you are not using an EPROM driver, select the "No EPROM Driver" option.
- Otherwise, select the appropriate entry for your programming device.
- If you are using a PC, you can select a driver for an external PROM programmer. You must also specify the interface (e.g. LPT1) to which the PROM programmer is connected.

On setting the programming device/PC interface

During installation, a program for setting the PG/PC interface is also installed.

After installing COM PROFIBUS, you can start this program as follows from the Windows Start menu:

Start > Programs > Siemens COM PROFIBUS > Set for the PG/PC Interface

Possible settings:

- To run the programming device/PC online, set the access point of the application to COM PROFIBUS and adapt the interface parameters of the PROFIBUS card accordingly.
- Check whether the default interrupts and the default address areas on your computer are free, and select free interrupts and/or address areas, if necessary (you will find a detailed description in the online help system).

Uninstalling COM PROFIBUS

Use the standard Windows procedure to uninstall COM PROFIBUS:

1. Start the standard Windows dialog for uninstalling software by double-clicking the "Add/Remove Programs" icon in "Control Panel".
2. Select COM PROFIBUS from the list of installed software, and then click the "Add/Remove" button to uninstall the software.

Starting COM PROFIBUS

You start COM PROFIBUS from the Windows Start menu:

Start > Programs > Siemens COM PROFIBUS > COM PROFIBUS

After installation, you can also start COM PROFIBUS in Microsoft Windows Explorer by double-clicking a program file with the extension *.pb5.

3 User interface

Overview

The COM PROFIBUS user interface is Windows-like with the following standard elements (example):

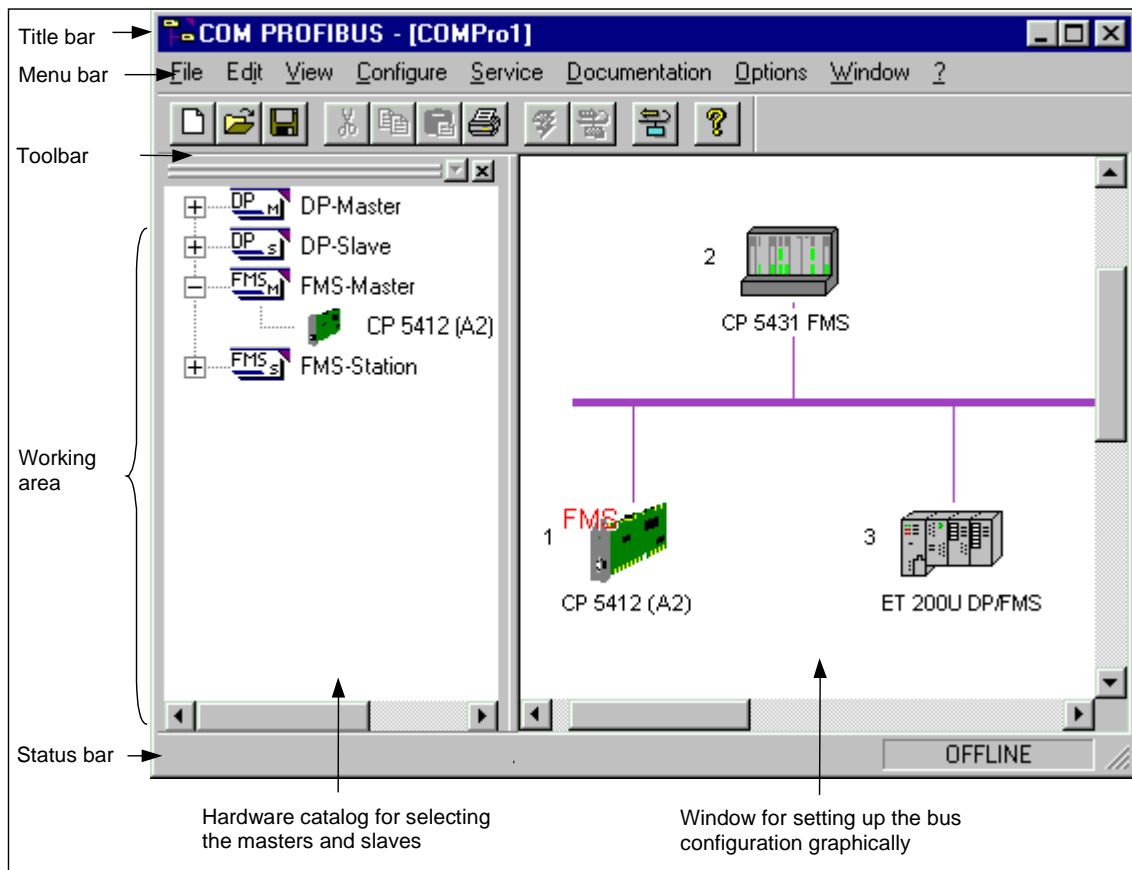

Figure 3-1 Control elements of COM PROFIBUS

Title bar

The title bar always contains only the name of the application, in this case "COM PROFIBUS".

Status bar

The status bar contains a short description of the current command, COM PROFIBUS's current activity or operating instructions.

Menu bar

The names of the various menus appear in the menu bar. The menus allow you to call the following functions:

Table 3-1 Functions of the menus

Menu	Allows you to
File	Open, save and close program files Read (import) master systems from a memory card, DP master, binary file, NCM file or ASCII file Transfer (export) master systems to a memory card, DP master, binary file or NCM file Open, read in or create device master files Print documentation
Edit	Cut, copy, paste and delete selected DP slaves or FMS stations
View	Change between the view of a master system and the view of the entire bus
Configure	Enter the bus, host and master parameters and the DP slave parameters or FMS station properties
Service	Display the diagnostic overview and slave diagnosis Display and control the signal states of the inputs/outputs of the slaves Change the PROFIBUS address of a slave via the PROFIBUS bus system Activate a parameter set after an export to the DP master Set the parameters of the PROFIBUS card Display the data cycle times Switch the programming device/PC offline Delete the memory card
Documentation	Output documentation
Options	Set the language
Window	Change the view on the screen Open/close the hardware catalog
Help	Access the help system

Mouse

The mouse buttons have the following functions in COM PROFIBUS:

Table 3-2 Functions of the mouse buttons

Do this	To achieve this
Click the left mouse button once	Select an item/object
Double-click the left mouse button	Open the associated dialog box
Hold down the right mouse button	Open the pop-up menu, which contains the most important functions

Toolbar

The toolbar contains buttons corresponding to menu commands:



File > New

Creates a new program file.



File > Open

Opens an existing program file.



File > Save

Saves the configuration in the current program file.



Edit > Cut

Cuts the selected PROFIBUS node to the clipboard.



Edit > Copy

Copies the selected PROFIBUS node to the clipboard.



Edit > Paste

Pastes the PROFIBUS node cut or copied to the clipboard.



Print

Prints the documentation of the open documentation window.



File > Export > Memory Card

Exports the current master system to a memory card.



File > Export > DP Master

Exports the current master system to the DP master.



File > Import > DP Master

Imports the master system from the DP master to the current program file.



? > Help Topics

Opens the online help system.

Hardware catalog (window on left)

The hardware catalog contains all the devices that can be configured using COM PROFIBUS and presents them in the form of a tree structure. As in Microsoft Windows Explorer, the various containers with the modules can be opened and closed.

Only those devices for which there is an error-free device master file in COM PROFIBUS's (...gsd or ...fmsgsd) directory are displayed.

You have to notify COM PROFIBUS about a new or changed device master file by means of the **File > Read in GSD Files** menu command.

Table 3-3 Working with the hardware catalog

Do this	To achieve this
Press <+> (numeric keypad)	Open the whole catalog
Press <-> (numeric keypad)	Close the whole catalog
Drag and drop or double-click the device	Move the device from the hardware catalog to the window on the right for the bus configuration

Window containing the bus configuration (window on the right)

In this window you create a graphical representation of the bus configuration. You drag and drop the devices from the hardware catalog in this window.

Table 3-4 Working in the window containing the bus configuration

Do this	To achieve this
Drag and drop	Change the arrangement of the devices in the PROFIBUS bus system
Double-click the device	Open the dialog box for parameter assignment
Right-click the device	Open a pop-up menu containing the most important functions

4 PROFIBUS-DP configuration example

Purpose of the example

This chapter demonstrates all the important functions of COM PROFIBUS in a sample configuration for PROFIBUS-DP.

The procedure suggested here for creating a DP configuration is designed to help you become familiar with the COM PROFIBUS configuration software as quickly and easily as possible.

The sequence in which the steps appear here is recommended rather than absolutely necessary.

Sample structure of a DP configuration

The following PROFIBUS devices are used in the example described below:

- The IM 308-C as the DP master (S5-115U/CPU 945 host)
- The ET 200B as a compact DP slave (ET 200B-4/8AI)
- The ET 200M as a modular DP slave
- The ET 200S as a fine-step modular DP slave
- The IM 308-C as a DP slave (S5-115U/CPU 945 host)

Transmission method

RS 485 transmission method for electrical networks on the basis of shielded twisted-pair cables

Network components

No additional network components such as OLMs, RS 485 repeaters, etc.

Bus protocol

PROFIBUS-DP: This bus protocol applies when there are DP masters based on the EN 50170, Volume 2, PROFIBUS standard on the bus.

4.1 Starting configuration

Start COM PROFIBUS

From the Windows **Start menu**, choose:

Start > Programs > Siemens COM PROFIBUS > COM PROFIBUS

Result: The COM PROFIBUS user interface appears and an empty program file is created.

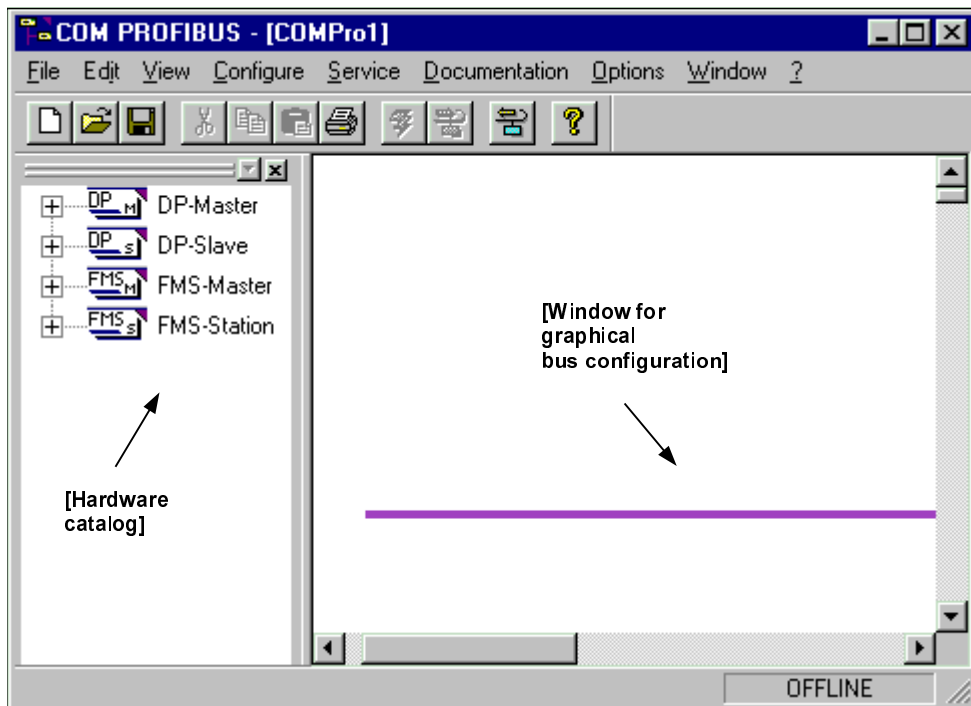

Figure 4-1 Configuration with COM PROFIBUS

Read in the device master files

Choose the **File > Read in GSD Files** menu command.

Result: All the configurable bus nodes are displayed in the hardware catalog.

Note

You only need to execute this function when a new device master file is copied to COM PROFIBUS's ...\\gsd subdirectory or an existing device master file in the subdirectory is changed **after** the program is started up.

4.2 Setting up the bus configuration

You begin configuration by selecting and arranging the DP masters and DP slaves in the window for the graphical bus configuration. Not until you have created all the PROFIBUS nodes do you begin setting the parameters.

Several masters on the bus

The configuration for a master system is shown below. If there are several DP masters on the bus, you can use the **View > Network View** and **View > Mastersystem <1>** menu commands to switch between the view of the whole bus and the view of a master system during configuration.

Set up the bus configuration graphically

Select the DP master and the associated DP slaves from the hardware catalog, and drag and drop the modules one after the other to move them to the window on the right for the graphical bus configuration (see Figure 4-1).

Tip 1: Double-click the modules in the catalog to set up the configuration more quickly.

Tip 2: Press <+> and <-> on the numeric keypad to open and close the entire catalog.

Select the following modules from the hardware catalog for the sample configuration:

```
DP master > IM 308-C > S5-115U / CPU 945 (host)
DP slave > I/O > ET 200B > B-4/8AI-2 DP
DP slave > I/O > ET 200M > ET 200M (IM 153-1)
DP slave > I/O > ET 200S > ET 200S (IM 151)
DP slave > PLC > SIMATIC > IM 308-C DP slave > S5-115U/CPU945
```

Result: The bus configuration is created with icons for all the modules (Figure 4-2)

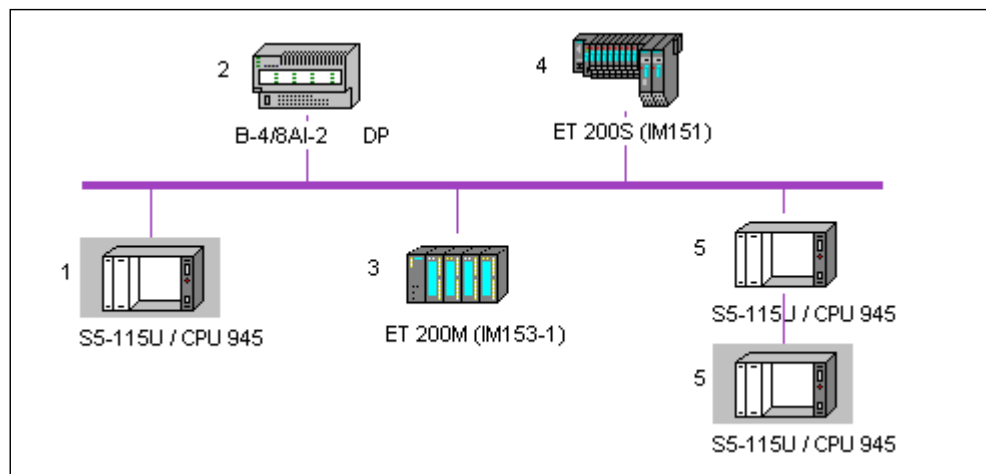

Figure 4-2 Structure of a sample DP configuration

4.3 Entering bus parameters

Once you have set up the bus configuration graphically, you begin parameterization. The bus parameters apply to the entire PROFIBUS bus system. If your bus configuration includes a number of master systems, you only need to set the bus parameters in one of them.

Enter the bus parameters

1. Choose **Configure > Set bus parameters**.

Result: The "Bus Parameters" dialog box appears.

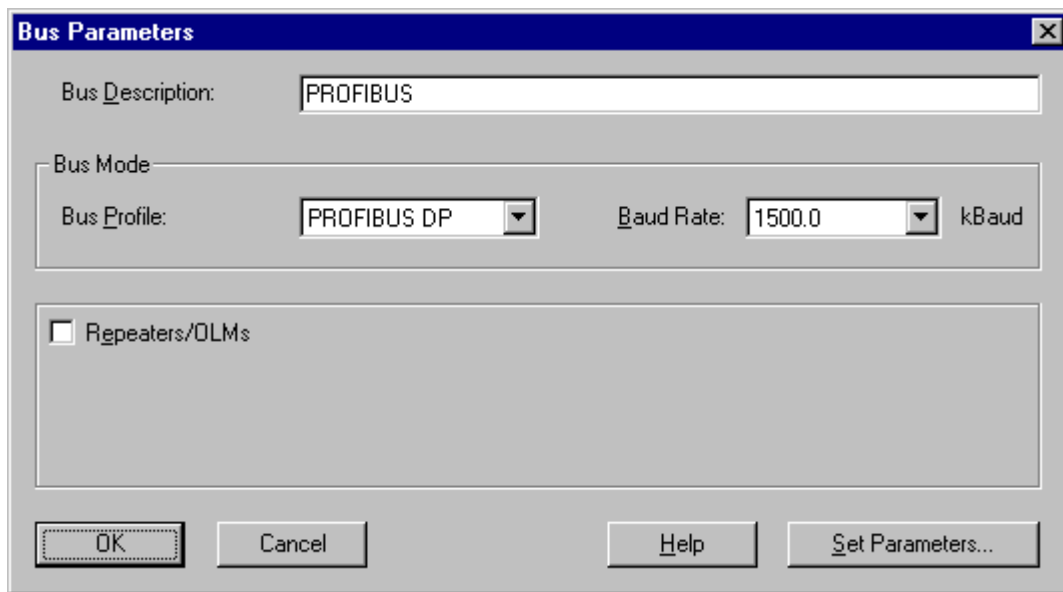

Figure 4-3 The "Bus Parameters" dialog box

2. Select the "PROFIBUS-DP" bus profile.

"PROFIBUS-DP" applies when only DP masters that comply with the EN 50170, Volume 2, PROFIBUS standard are on the bus. The bus profiles are default sets of bus parameter settings for different PROFIBUS applications. Each bus profile contains PROFIBUS bus parameters calculated and set by COM PROFIBUS for a specific configuration, profile and transmission rate.

Tip: You can click the "Set Parameters" button to view the bus parameters calculated by COM PROFIBUS. The calculated bus parameters can only be changed if the "Adjustable" bus profile is selected.

3. Select a transmission rate of 12000.0 kbps.

The transmission rate set here applies to the entire PROFIBUS-DP bus system. In other words, all nodes on the PROFIBUS-DP bus system must support the selected transmission rate.

4. Click "OK" to apply the bus parameters and exit the dialog box.

Result: The bus parameters are saved.

Repeaters/OLMs

If there are RS 485 repeaters in electrical networks or OLMs/OBTs in optical networks on the PROFIBUS-DP bus system, select the "Repeater/OLMs" check box. The number of network components to be specified and the cable lengths are taken into account by COM PROFIBUS when calculating the bus parameters.

Note

The network components configured **in the network view** of COM PROFIBUS have no effect on the bus times calculated. If these network components are to be taken into account, you must increase the number for "Repeaters/OLMs" in the "Bus parameters" dialog box.

Change the bus parameters individually (optional)

Normally - i.e. when the DP masters are configured with COM PROFIBUS - you do not need to change the default bus parameter settings in the bus profile.

However, if you do want to adapt the bus parameters yourself and have the required PROFIBUS expertise, select the "Adjustable" bus profile and then click the "Set Parameters" button. In the "Bus parameters" dialog box that appears you can adapt the bus parameters yourself to suit your bus configuration. Please look up the information on this in the **online help system** ("Help" button).

Note

Always set the slowest bus time of all bus nodes.

All the values for the bus parameters are specified in the unit t_bit (bit time). The bit time depends on the transmission rate and is calculated using the following formula: $t_bit [\mu s] = 1/\text{transmission rate [1000 kbps]}$.

Table 4-1 Bit time depending on the transmission rate

Transmission rate	t_bit [μs]
9.6 kbps	104.167
19.2 kbps	52.083
45.45 kbps	22.002
93.75 kbps	10.667
187.5 kbps	5.333
500 kbps	2.000
1500 kbps	0.667

Transmission rate	t_bit [μ s]
3000 kbps	0.333
6000 kbps	0.167
12000 kbps	0.083

Target rotation time "Ttr"

The bus parameter "Ttr" calculated by COM PROFIBUS and shown here does not represent the real target rotation time; it represents a maximum permitted value and thus cannot be used to determine response times on the PROFIBUS-DP bus system.

4.4 Entering master parameters

You use the master parameters to specify how the distributed I/Os are addressed and how the DP master is to respond in the event of errors on the PROFIBUS-DP bus system.

Enter the master parameters

1. Double-click the IM 308-C "S5-115U / CPU 945" icon in the window for the graphical bus configuration (see Figure 4-2).

Result: The "Master parameters" dialog box appears.

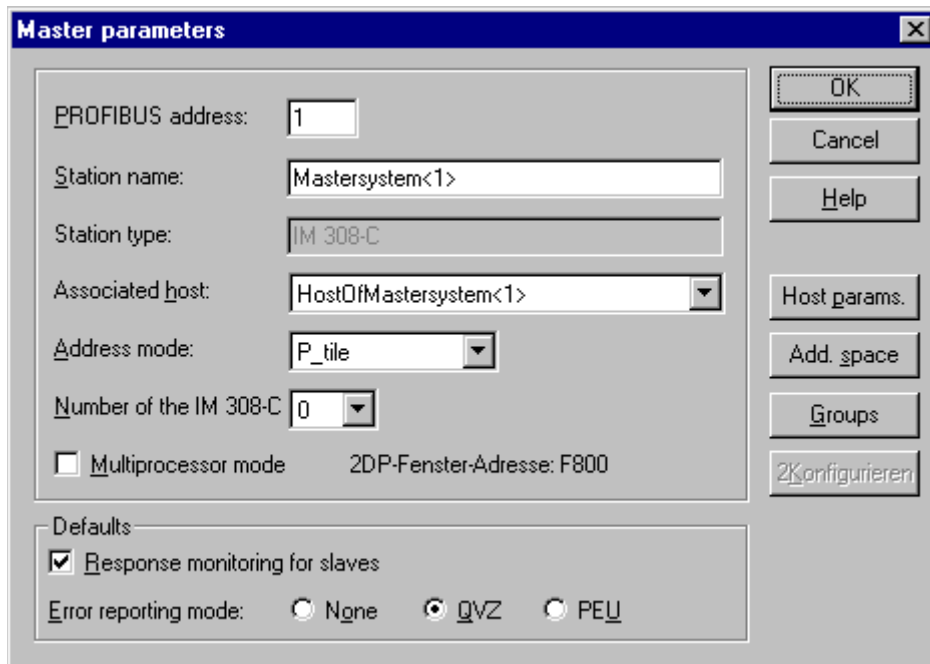

Figure 4-4 The "Master parameters" dialog box

- Set the master parameters for the IM 308-C:

Parameter	Value
PROFIBUS address	Keep "1"
Address mode	Set to "P tile"
Number of the IM 308-C	Keep "0"
Multiprocessor mode	Keep "Deactivated"
Response monitoring for slaves	Keep "Activated"
Error reporting mode	Keep "QVZ"

- You need the number of the IM 308-C for tile (page frame) addressing or for addressing by means of the FB IM308C.
- You must activate multiprocessor mode for the IM 308-C if you are running several CPUs and masters on a single host or if the address space occupied by the FB IM308C is already being used for the CPs/IPs inserted in the programmable controller.
- If "Response monitoring for slaves" is activated, it applies to all DP slaves assigned to the DP master. For commissioning you can switch off response monitoring for individual slaves during slave configuration.

Further support: Please also note the information on each master parameter in the **online help system** ("Help" button).

- Click "OK" to apply the master parameters and exit the dialog box.

Result: The master parameters are saved.

"Host params." button

This button opens a dialog box for protecting address areas (see Section 4.5).

"Add. space" button

This button opens the address space dialog box, which gives you an overview:

- Of all the host's available address space
- Of the address areas occupied by configured slaves
- Of the address areas you reserved during host parameterization

"Groups" button

Opens a dialog box for defining the groups for the purpose of issuing the control commands FREEZE and SYNC to DP slaves (see Section 4.10).

4.5 Entering host parameters

A host is a system or device on which there are one or more masters. In our example the CPU 945 is the host of the IM 308-C. If there is no system above the master in the hierarchy - as in the case of the S5-95U with a DP master interface, for example - the master is treated as a host.

You can use the host parameters to reserve input and output addresses for the central I/O modules in the programmable controller and set the power-up delay of the CPU 945 before all the DP slaves on the PROFIBUS bus system are addressed.

Enter the host parameters

1. Double-click the IM 308-C "S5-115U / CPU 945" icon in the window for the graphical bus configuration (see Figure 4-2).

2. Click the "Host params." button in the "Master parameters" dialog box.

Result: The "Host parameters" dialog box appears.

3. Enter a realistic time for the power-up delay.

The power-up delay can be between 20 s and 1200 s. If you specify no error reporting mode for the IM 308-C when setting the master parameters, the CPU starts up without a power-up delay.

4. Click the "Reserv. I." button in the "Host parameters" dialog box.

Result: The "Reserve address areas for inputs" dialog box appears.

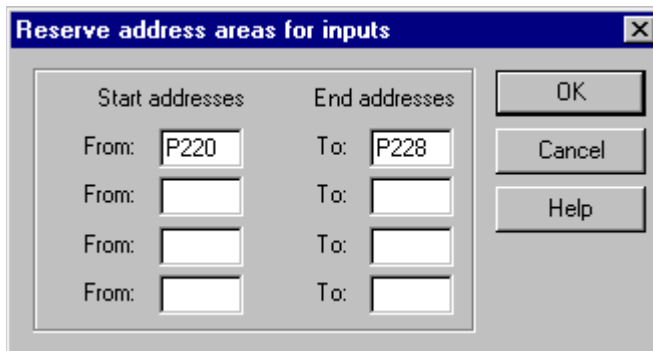

Figure 4-5 The "Reserve address areas for inputs" dialog box

5. Specify to the IM 308-C the address areas for central input modules of the CPU 945, and then click "OK" to close the dialog box.

For example: "P210" to "P218" ("P210" stands for byte 210 in the P area)

6. Reserve the address areas for central output modules in the same way (e.g. "P220" to "P228").

- Click "OK" to apply the host parameters and close the dialog box.

Result: The host parameters are saved.

Further support: Please also note the information on each host parameter in the **online help system** ("Help" button).

Note

In the case of P or Q tiling, the reserved areas apply to all tiles (page frames).

4.6 Entering slave parameters for the ET 200B

You can now configure and parameterize the DP slaves one after the other. In our example we will begin with the ET 200B as a compact DP slave. In order to be able to illustrate parameter assignment to you in detail, we have decided on the ET 200B-4/8AI-2 analog module.

Enter the slave properties

- Double-click the "B-4/8AI-2 DP" icon in the window for the graphical bus configuration (see Figure 4-2).

Result: The "Slave properties" dialog box appears.



Figure 4-6 The ET 200B "Slave properties" dialog box

- Set the slave properties for the ET 200B-4/8AI-2:

Parameter	Value
PROFIBUS address	Keep suggestion "2"
Control command	"FREEZE capable" (unchangeable)
Param. assignment master	Keep suggestion "1, IM 308-C, master system <1>"
Response monitoring	Keep "Activated"
Error reporting mode	Keep "QVZ"

- If there is more than one DP master on the PROFIBUS bus system, you can use the "Param. assign. master" list box to check the DP master that parameterizes the DP slave and, if necessary, change it.
- If "Response monitoring for slaves" is selected in the "Master parameters" dialog box, you can switch response monitoring on and off here for each DP slave (e.g. for commissioning).
- "FREEZE-capable" indicates that the DP slave can execute this control command of the DP master. COM PROFIBUS obtains this information from the device master file.

Further support: Please also note the information on the slave properties in the **online help system** ("Help" button).

Response monitoring

If response monitoring is switched on, the DP slave will respond within the configured response monitoring time (bus parameters) in the event of data traffic with the DP master failing. After the response monitoring time elapses, the DP slave switches to a safe state. In other words, all outputs are set to the signal state "0" or (if the DP slave supports it) substitute values are output.



Danger

If you switch off response monitoring for a DP slave, in the event of a failure the outputs of the DP slave may **not** be set to "0". This can lead to dangerous system states.

Configure the DP slave

- Click the "Configure" button in the "Slave properties" dialog box.
Result: The "Desired configuration" dialog box appears.
- Accept "Configuration 1 8AI" by clicking "OK".

In the "Desired configuration" dialog box you make a selection for the address identifiers in the configuration table that follows. This dialog box only appears if there are different address types in the device master file for the slave.

Result: The "Configure" dialog box, also referred to as the configuration table, appears. The address identifier "067, 071" appears at slot 4 for 8AI.

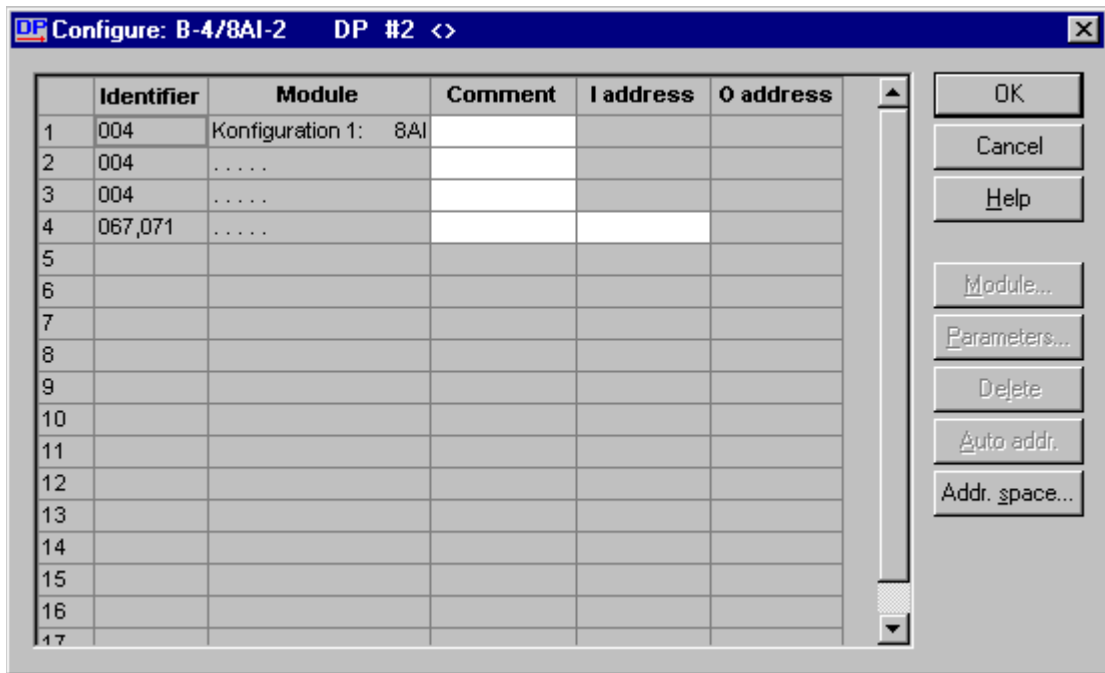

Figure 4-7 The ET 200B "Configure" dialog box

3. Select the free cell in the "I address" column, and then click the "Auto addr." button.

Result: The address identifier is assigned to the next free input address of a P tile. As of this address the 8 input channels of the ET 200B-4/8AI are addressed in the P area (with word consistency). Note the addresses for programming in the user program.

Tip: Before you click the "Auto addr." button, you can select a row, a column or the whole table.

Tip: The "Identifier" pop-up menu command (which you access by right-clicking the "Identifier" column) indicates the length and consistency of the address area of an identifier.

4. Click "OK" to accept the configuration and close the dialog box.

Result: COM PROFIBUS stores the configuration data in the configuration of the master system.

Further support: Please also note the information on working with the configuration table in the **online help system** ("Help" button).

Digital compact DP slaves

Note

For digital compact ET 200B distributed I/O devices, slave parameterization is concluded at this point. No further settings are required. By default in the "Parameterize" dialog box ("Parameterize" button), 5 bytes containing "00" are specified that cannot be deleted or overwritten.

Parameterize the analog DP slave

1. Click the "Parameterize" button in the "Slave properties" dialog box.

Result: The "Parameterize" dialog box appears for the ET 200B-4/8AI-2. The parameterizable parameters are displayed in the "Parameter name" column. The current parameter values appear in the "Value" column. COM PROFIBUS obtains these entries from the device master file of the DP slave.

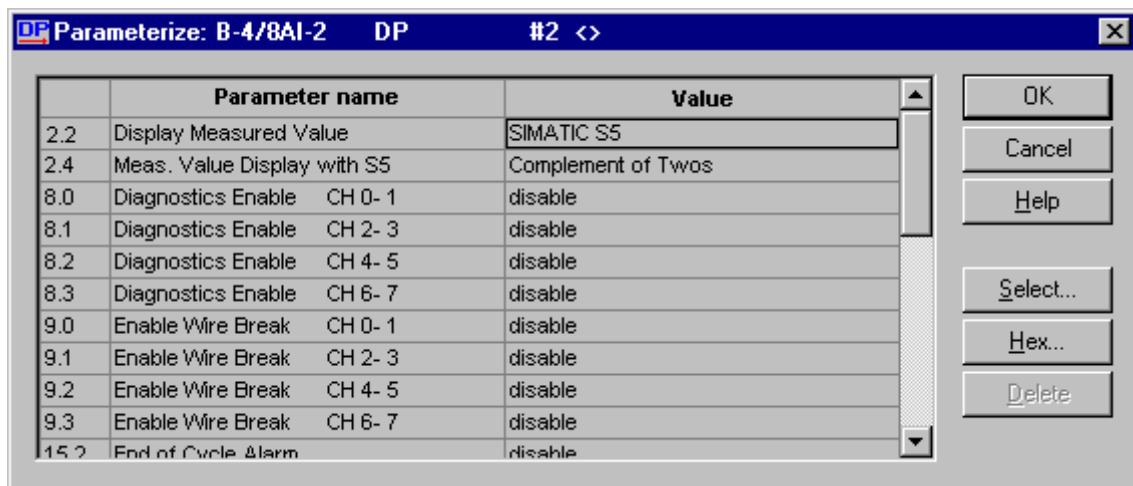

Figure 4-8 The ET 200B "Parameterize" dialog box

2. Set the slave parameters for the ET 200B-4/8AI-2: To do this, click the relevant row in the "Value" column and select the following parameter values from the dialog box that appears:

Parameter	Value
Measured value representation	Keep "SIMATIC S5"
S5 measured value representation	Keep "Twos complement"
Dagnostic enable	Switch to "Enable"
Wire break enable	Switch to "Enable"

Parameter	Value
Cycle end interrupt, Diagnostic interrupt, Limit interrupt	Keep "Disable"
Integration time	Keep "20 ms for 50Hz"
Measurement type/Measurement range	Keep "Voltage +/- 1 V"
Upper/Lower limit	Keep "0"

- If you do not want to use a channel of the module, set the "Measurement type/Measurement range" parameter to "Channel not activated".

Further support: Refer to the **DP slave manual** for information on the various parameters of the DP slaves.

3. Click "OK" to apply the parameterization and close the dialog box.

Result: COM PROFIBUS stores the parameter data in the configuration of the master system.

4.7 Entering slave parameters for the ET 200M

We are now going to parameterize the ET 200M as a modular DP slave fitted with two S7-300 I/O modules (8DE, 4AA).

Enter the slave properties

4. Double-click the "ET 200M (IM153-1)" icon in the window for the graphical bus configuration (see Figure 4-2).

Result: The "Slave properties" dialog box appears.

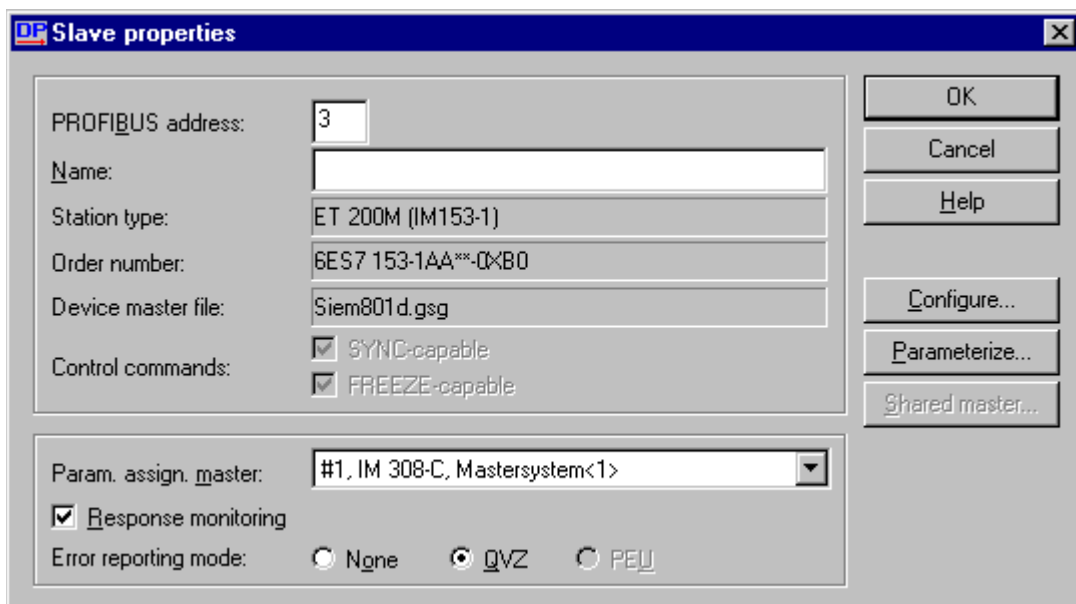

Figure 4-9 The ET 200M "Slave properties" dialog box

5. Set the slave properties for the ET 200M:

Parameter	Value
PROFIBUS address	Keep suggestion "3"
Param. assignment master	Keep suggestion "1, IM 308-C, master system <1>"
Response monitoring	Keep "Activated"
Error reporting mode	Keep "QVZ"

- If there is more than one DP master on the PROFIBUS bus system, you can use the "Param. assignment master" list box to assign the DP master to parameterize the DP slave.
- If "Response monitoring for slaves" is selected in the "Master parameters" dialog box, you can switch response monitoring on and off here for each DP slave (e.g. for commissioning).

Further support: Please also note the information on the slave properties in the **online help system** ("Help" button).

Response monitoring

If response monitoring is switched on, the DP slave will respond within the configured response monitoring time (bus parameters) in the event of data traffic with the DP master failing. After the response monitoring time elapses, the DP slave switches to a safe state. In other words, all outputs are set to the signal state "0" or (if the S7-300 I/O modules support it) substitute values are output.



Danger

If you switch off response monitoring for a DP slave, in the event of a failure the outputs of the S7-300 I/O modules may **not** be set to "0". This can lead to dangerous system states.

Configure the DP slave

1. Click the "Configure" button in the "Slave properties" dialog box.

Result: The "Configure" dialog box, also referred to as the configuration table, appears.

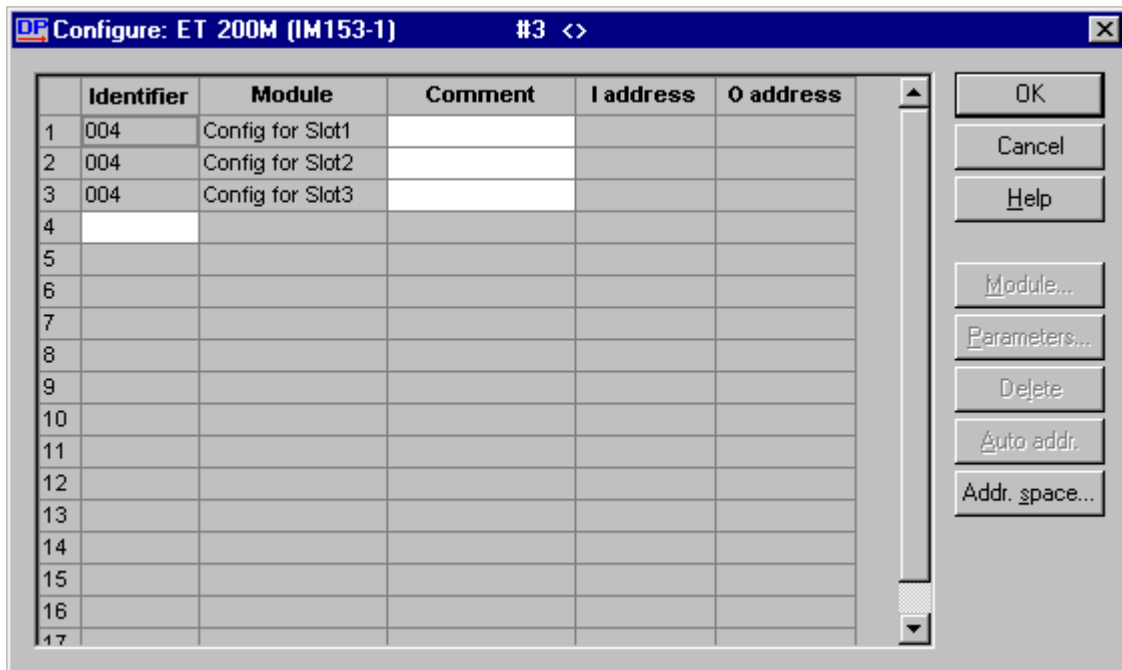

Figure 4-10 The ET 200M "Configure" dialog box

- Click the fourth cell in the "Module" column and then the "Module" button.

Result: A selection of all the configurable S7-300 I/O modules appears together with their order numbers.

- Select the I/O modules one after another in the sequence in which they are connected next to the ET 200M. In the example, we select the following:

- Slot 4: The 8DE digital input module (6ES7 321-1FF0*-0AA0)
- Slot 5: The 4AA analog output module (6ES7 332-5RD00-0AB0)

Result: The I/O modules are entered in the configuration table.

Note

The slot corresponds exactly to the slot of the I/O module in the ET 200M. The slots must be assigned in ascending order. No slots should be skipped. If a slot remains empty, an empty slot (identifier 0) must be configured for it.

- Click "Close" to close the selection of S7-300 I/O modules.
- Select the free cells in the "I address" and "O address" columns, and then click the "Auto addr." button.

Result: The next free addresses of a P tile are assigned to the address identifiers for 8DE and 4AA. The 8 digital inputs of the 8DE (with byte consistency) and the 4 analog output channels of the 4AA (with word consistency) are addressed as of this address.

Tip 1: You can also write start addresses of your choice in the free cells under "I address/O address".

Tip 2: The "Identifier" pop-up menu command (which you access by right-clicking the "Identifier" column) indicates the length and consistency of the address area of an identifier.

Tip 3: The "Address space" button provides you with an overview of the address areas that are still available and those that are already assigned.

Note

Configuration is concluded at this point for most digital S7-300 I/O modules. No further settings are required. In the case of analog S7-300 I/O modules, you still have to set the parameters for the analog channels (continue with step 6).

- Parameterize the 4AA analog module. Select the identifier "131", and then choose "Parameters" from the pop-up menu (by right-clicking the "Identifier" column).

Result: The "Parameterize" dialog box appears for the 4AA. The parameterizable parameters are displayed in the "Parameter name" column. The current parameter values appear in the "Value" column. COM PROFIBUS obtains these entries from the device master file of the DP slave.

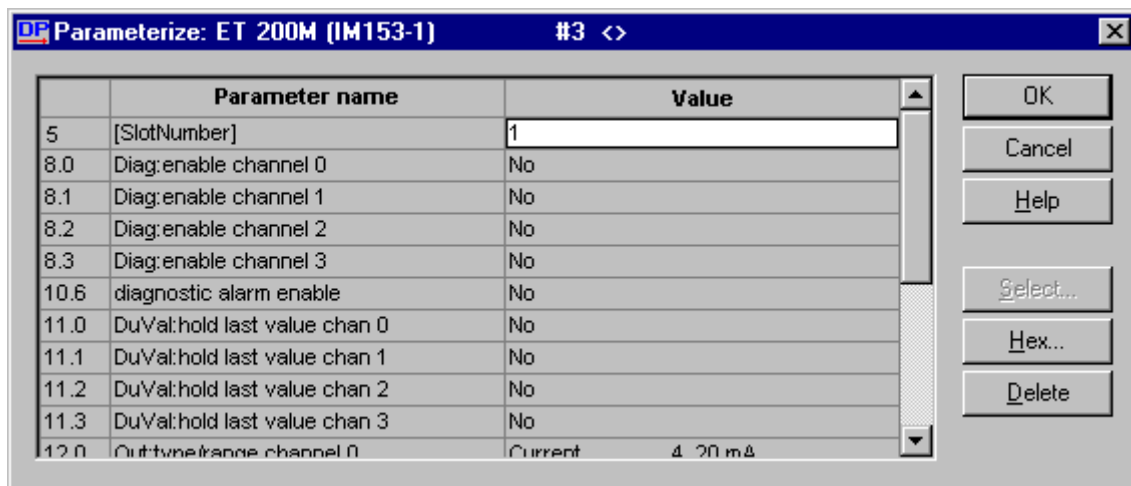

Figure 4-11 The 4AA "Parameterize" dialog box

- Set the parameters for the 4AA. To do this, click the relevant row in the "Value" column and select the following parameter values from the dialog box that appears:

Parameter	Value
Diag: Enable channel	Set "Yes"
Diagnostic interrupt enable	Set "Yes"
Sub. value: Hold last value	Set "Yes"
Output type/area channel	Keep "Current 4 .. 20 mA"
Sub. value: Value channel	Keep "-6912"

Further support: Refer to the **S7-300 I/O module manual** for information on the various parameters.

8. Click "OK" to apply the parameterization and close the dialog box.
9. Click "OK" to apply the configuration table and close the dialog box.

Result: COM PROFIBUS stores the parameter data and configuration data in the configuration of the master system.

Further support: Please also note the information on working with the configuration table in the **online help system** ("Help" button).

Parameterize the DP slave

1. Click the "Parameterize" button in the "Slave properties" dialog box.

Result: The "Parameterize" dialog box appears for the ET 200M. COM PROFIBUS obtains the entries from the device master file of the DP slave.

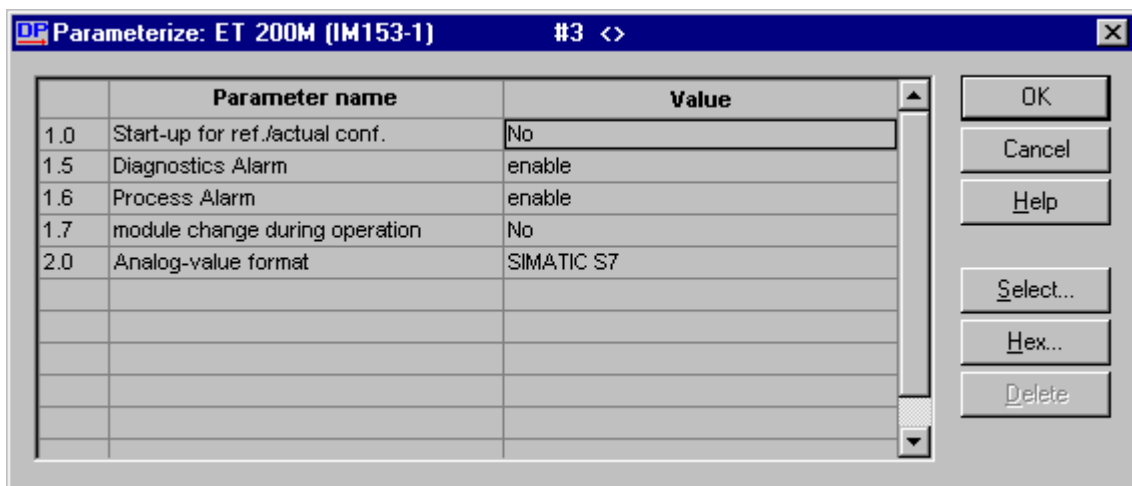

Figure 4-12 The ET 200M "Parameterize" dialog box

2. Set the slave parameters for the ET 200M: To do this, click the relevant row in the "Value" column and select the following parameter values from the dialog box that appears:

Parameter	Value
Start-up preset <-> actual config	Set "Yes"
Diagnostic interrupt	Keep "Enable"
Process interrupt	Keep "Enable"
Module change in operation	Keep "No"
Format presentation	Set "SIMATIC S5"

Further support: Refer to the **DP slave manual** for information on the various parameters of the DP slaves.

3. Click "OK" to apply the parameterization and close the dialog box.

Result: COM PROFIBUS stores the parameter data in the configuration of the master system.

4.8 Entering slave parameters for the ET 200S

We are now going to parameterize the ET 200S as an example of a fine-step DP slave fitted with digital input/output modules.

Enter the slave properties

1. Double-click the "ET 200S (IM151)" icon in the window for the graphical bus configuration (see Figure 4-2).

Result: The "Slave properties" dialog box appears.

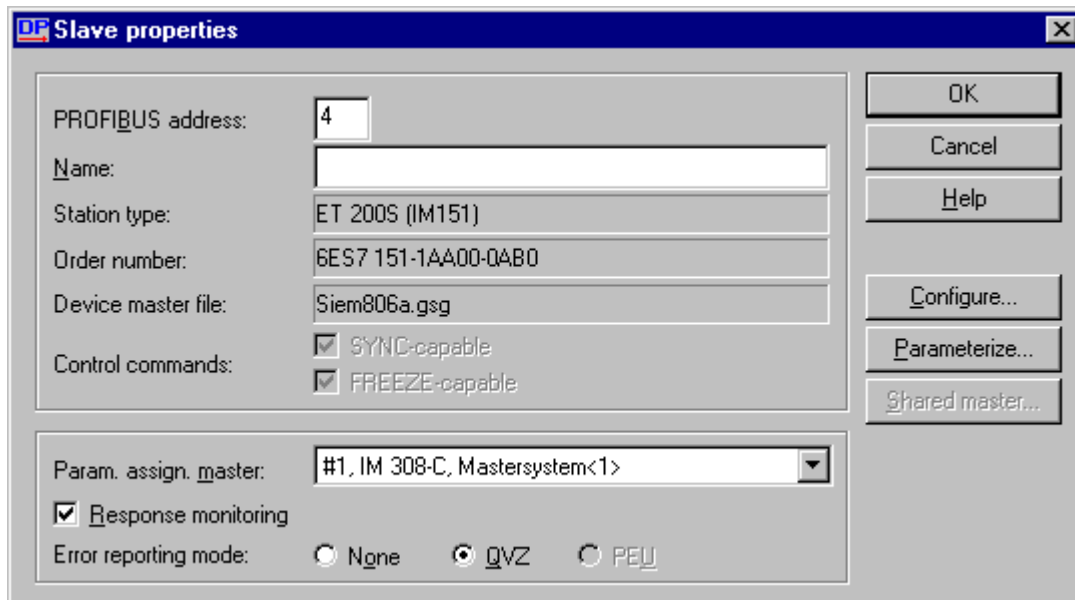

Figure 4-13 The ET 200S "Slave properties" dialog box

2. Set the slave properties for the ET 200S:

Parameter	Value
PROFIBUS address	Keep suggestion "4"
Param. assignment master	Keep suggestion "1, IM 308-C, master system <1>"
Response monitoring	Keep "Activated"
Error reporting mode	Keep "QVZ"
SYNC/FREEZE-capable	Selected (unchangeable)

- If there is more than one DP master on the PROFIBUS bus system, you can use the "Param. assignment master" list box to assign the DP master to parameterize the DP slave.
- If "Response monitoring for slaves" is selected in the "Master parameters" dialog box, you can switch response monitoring on and off here for each DP slave (e.g. for commissioning).
- "SYNC/FREEZE-capable" indicates that the DP slave can execute this control command of the DP master. COM PROFIBUS obtains this information from the device master file.

Further support: Please also note the information on the slave properties in the **online help system** ("Help" button).

Response monitoring

If response monitoring is switched on, the DP slave will respond within the configured response monitoring time (bus parameters) in the event of data traffic with the DP master failing. After the response monitoring time elapses, the DP slave switches to a safe state. In other words, all outputs are set to the signal state "0" or (if the output modules support it) substitute values are output.



Danger

If you switch off response monitoring for a DP slave, in the event of a failure the outputs of the output modules may **not** be set to "0". This can lead to dangerous system states.

Configure the DP slave

1. Click the "Configure" button in the "Slave properties" dialog box.

Result: The "Configure" dialog box, also referred to as the configuration table, appears.

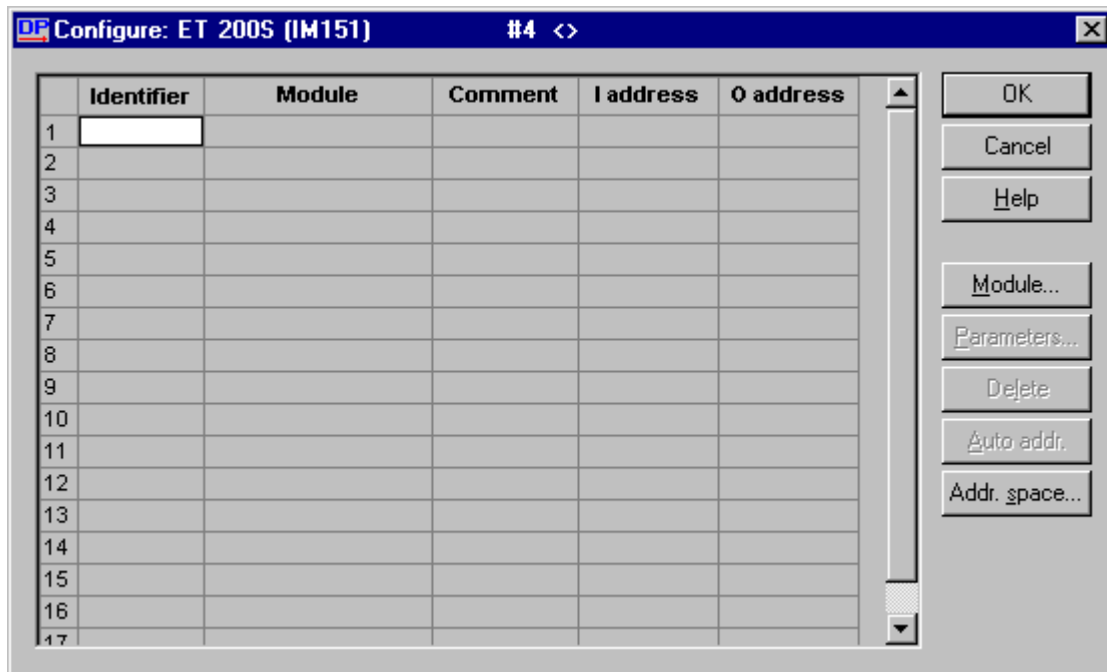

Figure 4-14 The ET 200S "Configure" dialog box

2. Click the first cell in the "Module" column and then the "Module" button.

Result: A selection of all the configurable ET 200S modules appears together with their order numbers.

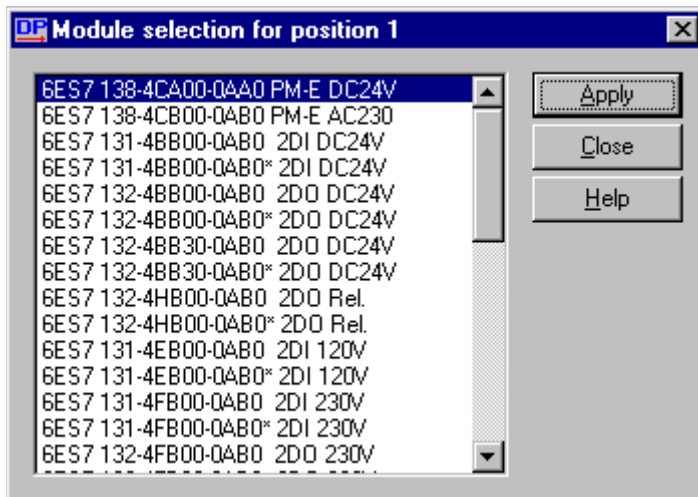

Figure 4-15 The ET 200S "Module selection" dialog box

3. Select the modules one after another in the sequence in which they are connected next to the ET 200S. In the example we will select several digital modules in order to illustrate the granular channel configuration.

Peculiarity of the ET 200S:

In the case of the ET 200S, certain electronic modules/load feeders can be grouped together in a single byte in the input and output area of the process image. You can identify these modules by the fact that they appear twice in the list, once with "*" and once without. 2DI DC 24V example (see Figure 4-15):

- 6ES7 131-4BB00-0AA0 2DI DC24V
- 6ES7 131-4BB00-0AA0* 2DI DC24V

Principle:

When you start a new byte, select a module without "*". Select all the subsequent modules in this byte with "*". If the byte is full (a maximum of 8 channels = 1 byte), a new byte must be started with the next module. In the example we select 8 digital 2DI input modules and thus occupy a total of 3 bytes.

Result: The 2DI input modules appear in the configuration table (see Figure 4-16).

Note

The slot corresponds exactly to the slot of the module in the ET 200S. The modules grouped together in a byte must be inserted immediately next to each other and be of the same module type (e.g. DI). There must not be more than 8 channels (1 byte) in total.

4. Click "Close" to close the module selection dialog box.
5. Select the free cells in the "I address" and "O address" columns, and then click the "Auto addr." button.

Result: The next free addresses of a P tile are assigned to the address identifiers. The digital input modules are addressed as of this address. In our example the 2DI at slot 1 has the start address 209.0, and the 2DI at slot has the start address 209.2.

Tip 1: You can also write start addresses of your choice in the free cells under "I address/O address".

Tip 3: The "Address space" button provides you with an overview of the address areas that are still available and those that are already assigned.

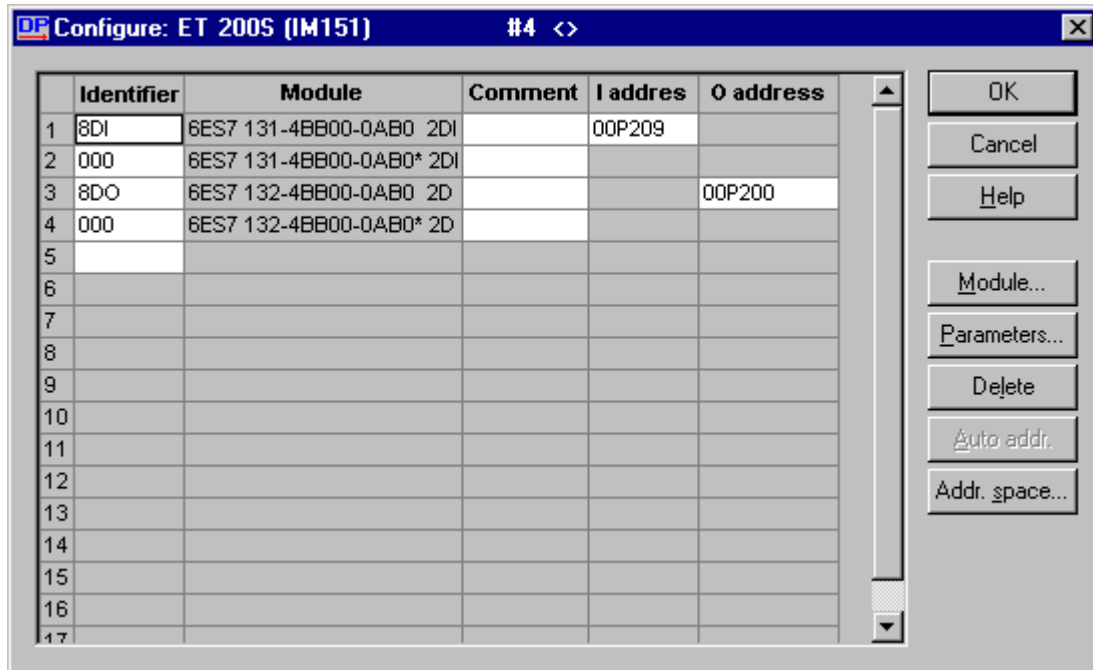

Figure 4-16 The ET 200S "Configure" dialog box

- Parameterize the parameterizable modules of the ET 200S. Select the corresponding identifier (e.g. 8DE for 2DI), and then choose "Parameters" from the pop-up menu (by right-clicking the "Identifier" column).

Result: The "Parameterize" dialog box appears for the 2DI. The parameterizable parameters are displayed in the "Parameter name" column. The current parameter values appear in the "Value" column. COM PROFIBUS obtains these entries from the device master file of the DP slave.

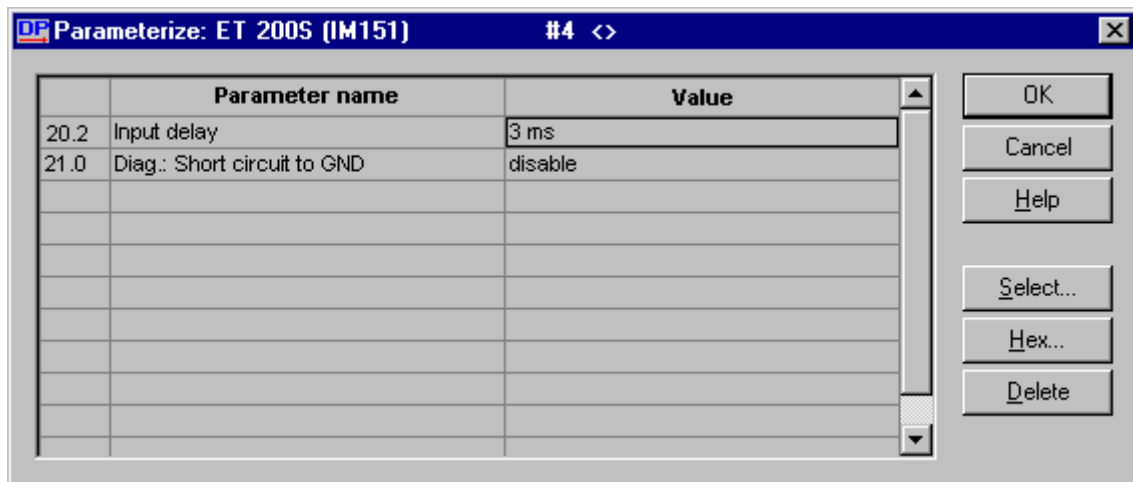

Figure 4-17 The 2DI "Parameterize" dialog box

- Set the parameters for the 2DI input module. To do this, click the relevant row in the "Value" column and select the parameter values from the dialog box that appears:

Parameter	Value
Input delay	Keep "3 ms"
Diag.: Short circuit to M	Switch to "Enable"

Further support: Refer to the **ET 200S manual** for information on the various parameters.

- Click "OK" to apply the parameterization and close the dialog box.
- Click "OK" to apply the configuration table and close the dialog box.

Result: COM PROFIBUS stores the parameter data and configuration data in the configuration of the master system.

Further support: Please also note the information on working with the configuration table in the **online help system** ("Help" button).

Parameterize the DP slave

- Click the "Parameterize" button in the "Slave properties" dialog box.

Result: The "Parameterize" dialog box appears for the ET 200S. COM PROFIBUS obtains the entries from the device master file of the DP slave.

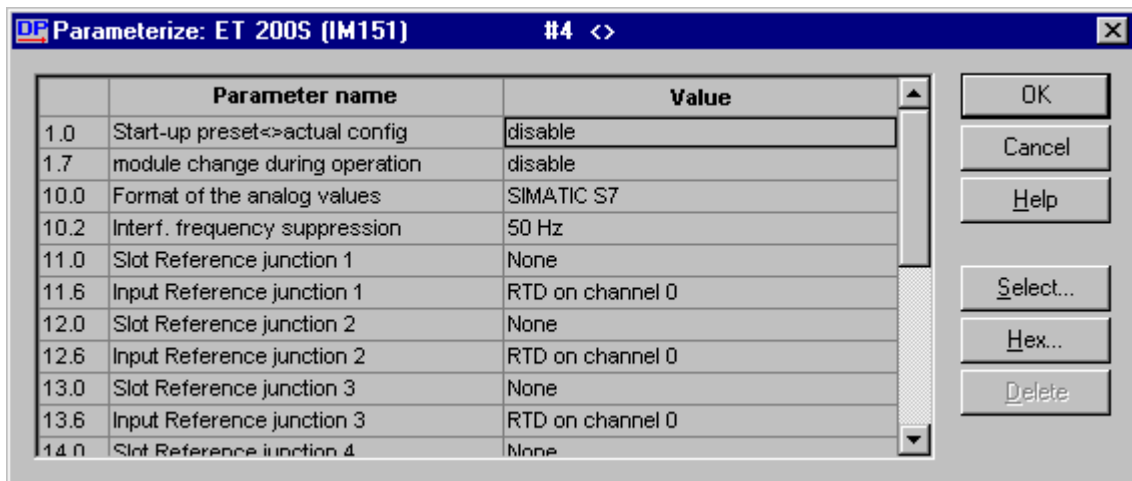

Figure 4-18 The ET 200S "Parameterize" dialog box

- Set the slave parameters for the ET 200S: To do this, click the relevant row in the "Value" column and select the following parameter values from the dialog box that appears:

Parameter	Value
Start-up preset <> actual config	Set "Yes"
Module change in operation	Keep "Disable"
Analog value format	Set "SIMATIC S5"
Interference frequency suppression	Keep "50 Hz"
Reference junction slot 1 ... 8	Keep "None"
Reference junction input 1 ... 8	Keep "RTD on channel 0"

Further support: Refer to the **DP slave manual** for information on the various parameters of the DP slaves.

- Click "OK" to apply the parameterization and close the dialog box.

Result: COM PROFIBUS stores the parameter data in the configuration of the master system.

4.9 Entering slave parameters for the IM 308-C DP slave

Finally, we are going to parameterize the IM 308-C as a DP slave. You use the IM 308-C as a DP slave to transfer data quickly between two programmable controllers. We assume that these IM 308-C modules are **not** being used as DP masters at the same time.

Enter the slave properties

- Double-click the upper "S5 115U / CPU 945" icon (PROFIBUS address 5) in the window for the graphical bus configuration (see Figure 4-2).

Result: The "Slave properties" dialog box appears.

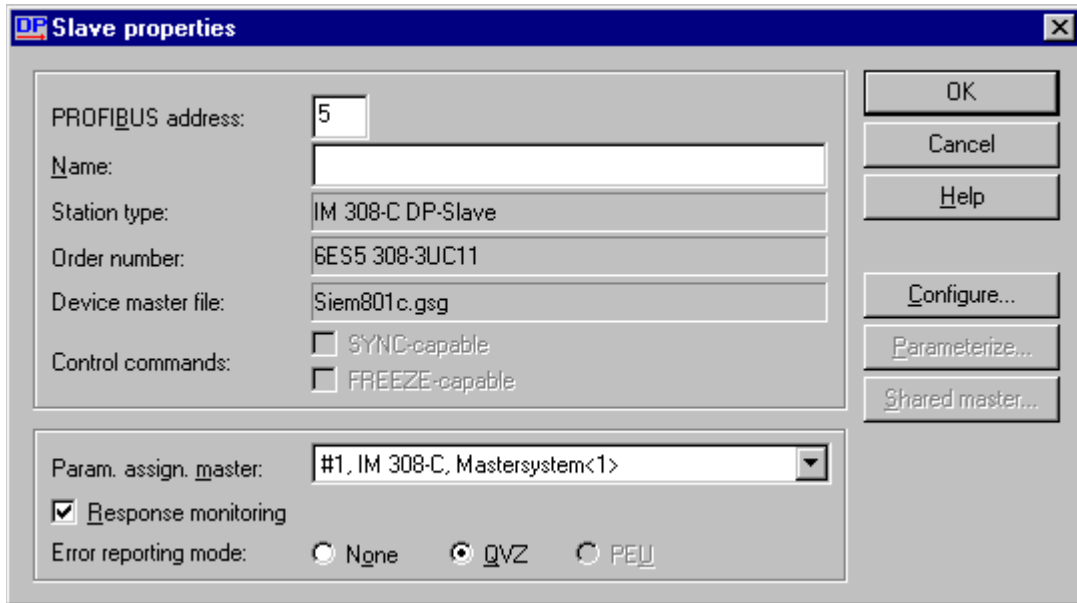

Figure 4-19 The IM 308-C DP slave "Slave properties" dialog box

- Set the slave properties for the IM 308-C DP slave:

Parameter	Value
PROFIBUS address	Keep suggestion "5"
Param. assignment master	Keep suggestion "1, IM 308-C, master system <1>"
Response monitoring	Keep "Activated"
Error reporting mode	Keep "QVZ"

- If there is more than one DP master on the PROFIBUS bus system, you can use the "Param. assignment master" list box to assign the DP master to parameterize the DP slave.
- If "Response monitoring for slaves" is selected in the "Master parameters" dialog box, you can switch response monitoring on and off here for each DP slave (e.g. for commissioning).

Further support: Please also note the information on the slave properties in the **online help system** ("Help" button).

Response monitoring

When the IM 308-C as a DP slave is no longer addressed by the DP master and response monitoring is activated, the IM 308-C goes into STOP mode after the response monitoring time elapses. Inputs of the IM 308-C are set to "0".

Configure the DP slave

1. Click the "Configure" button in the "Slave properties" dialog box.

Result: The "Configure" dialog box, also referred to as the configuration table, appears.

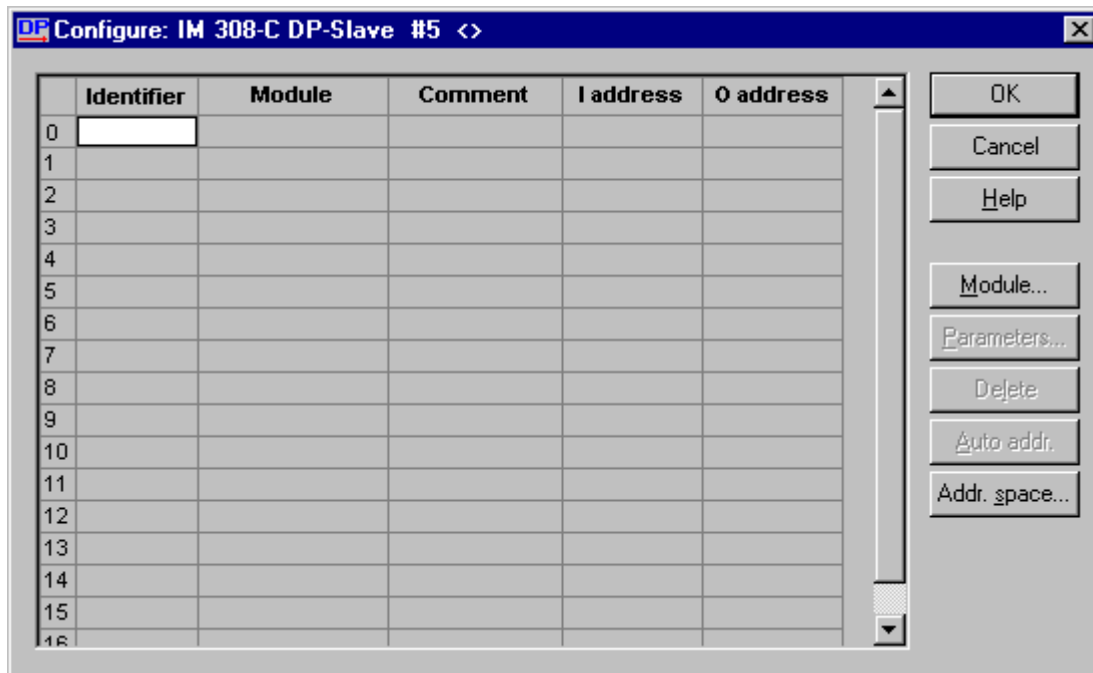

Figure 4-20 The IM 308-C DP slave "Configure" dialog box

In the configuration table you specify the size and the addresses of the DP slave inputs and outputs of the IM 308-C. The following applies:

- Inputs = input areas of the host CPU (IM 308-C DP slave)
 - Outputs = output areas of the host CPU (IM 308-C DP slave)
2. To do this, click a white field in the "Module" column followed by the "Module" button.

Result: A selection of all the configurable identifiers appears.

3. Select the corresponding identifiers depending on the type, length and consistency of the address areas, and then click "Close" to accept your selection.

For example: "4 words AI /AO/consist. total" for the identifier 4AX

Note

Address areas with a maximum of 16 words can be created.

4. Specify the identifiers for all the other address areas (DP slave inputs and DP slave outputs) in the same way.
5. Enter the start addresses of the address areas in the free cells under "I address/O address".

Tip: If specific addresses do not have to be specified, you can click the "Auto addr." button to assign the next free addresses automatically.

6. Click "OK" to apply the configuration and close the configuration table.

Result: COM PROFIBUS stores the configuration data in the configuration of the master system. In addition, COM PROFIBUS creates a separate master system for this IM 308-C.

Further support: Please also note the information on working with the configuration table in the **online help system** ("Help" button).

Note

When you have completed the bus configuration, do not forget to export this additional master system to the IM 308-C DP slave (see Section 4.14).

IM 308-C as DP slave, DP master not configured with COM PROFIBUS

What do you do when the IM 308-C is running as a DP slave in a master system whose DP master is not contained in COM PROFIBUS?

Simply create a master system with a DP master of your choice and configure the IM 308-C as a DP slave in this master system. COM PROFIBUS then automatically creates a separate master system for the IM 308-C DP slave, which you can export to the IM 308-C.

IM 308-C as a DP master and DP slave

The same IM 308-C can be run as a DP master and a DP slave provided there is another DP master on the bus.

You begin by configuring the IM-308-C as a DP slave in a master system. COM PROFIBUS then automatically creates a separate master system for the IM 308-C, which you can configure for the IM 308-C as a DP master.

4.10 Assigning groups

If you want to issue the FREEZE or SYNC control command from the DP master to DP slaves, you must arrange the DP slaves in groups. A group consists of at least one DP slave. Each DP slave can belong to several groups.

You can form up to 8 groups for each master system.

Requirement

The DP master must be able to issue the FREEZE and SYNC control commands, and the DP slave must be able to execute them. COM PROFIBUS obtains the relevant information from the device master file.

Specify group association

1. Double-click the "DP master: IM 308-C" icon in the window for the graphical bus configuration (see Figure 4-2).
2. Click the "Groups" button in the "Master parameters" dialog box.

Result: The "Groups and their properties" dialog box appears.

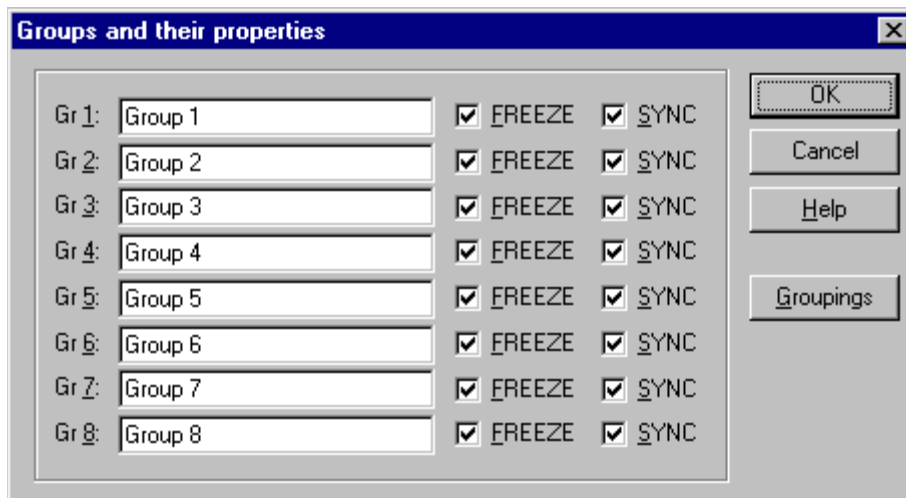

Figure 4-21 The "Groups and their properties" dialog box

3. In this dialog box you specify whether a group is to evaluate FREEZE and/or SYNC.
4. In the follow-on dialog box, "Groupings", you specify which DP slaves with which PROFIBUS addresses are to belong to which group. To do this, click the corresponding white fields.

Parameter	Value	Association
Group 1	Keep "FREEZE" and "SYNC" suggestion	ET 200B, ET 200M, ET 200S, IM 308-C DP slave

- Click "OK" to apply the entries.

Result: The DP slaves are now assigned to a group. You need the number of this group, for example, to issue control commands in the STEP 5 user program with the FB IM308C.

4.11 Saving the configuration

Our example is now fully configured. The configuration data has to be saved in a program file.

Save the configuration

- Choose the **File > Save as** menu command or .
- Enter a file name with the extension *.pb5, and then click "OK".

Result: The completed bus configuration is saved in the program file. You can export the configuration data to the DP masters.

4.12 Documenting and printing the configuration

You can use the **Documentation** menu to obtain a variety of information on the parameterized bus configuration. For example, you can display an overview of which addresses are assigned to which DP slave or which device master files are known to COM PROFIBUS. You can print out any overview you request.

In the following we request **by way of example** the assignment of the S5 addresses in order to check on the location of the input and output data of the DP slaves for the STEP 5 user program.

Further support: Please also refer to the detailed description of all the documentation options in the **online help system** (look under "Documentation").

Request area-oriented address assignment

- Choose **Documentation > Area-oriented Address Assignment**.
Result: The "Area-oriented Address Assignment" dialog box appears.
- Select the desired host and the address area.

Result: The address assignment of the parameterized bus configuration is displayed to you as follows:

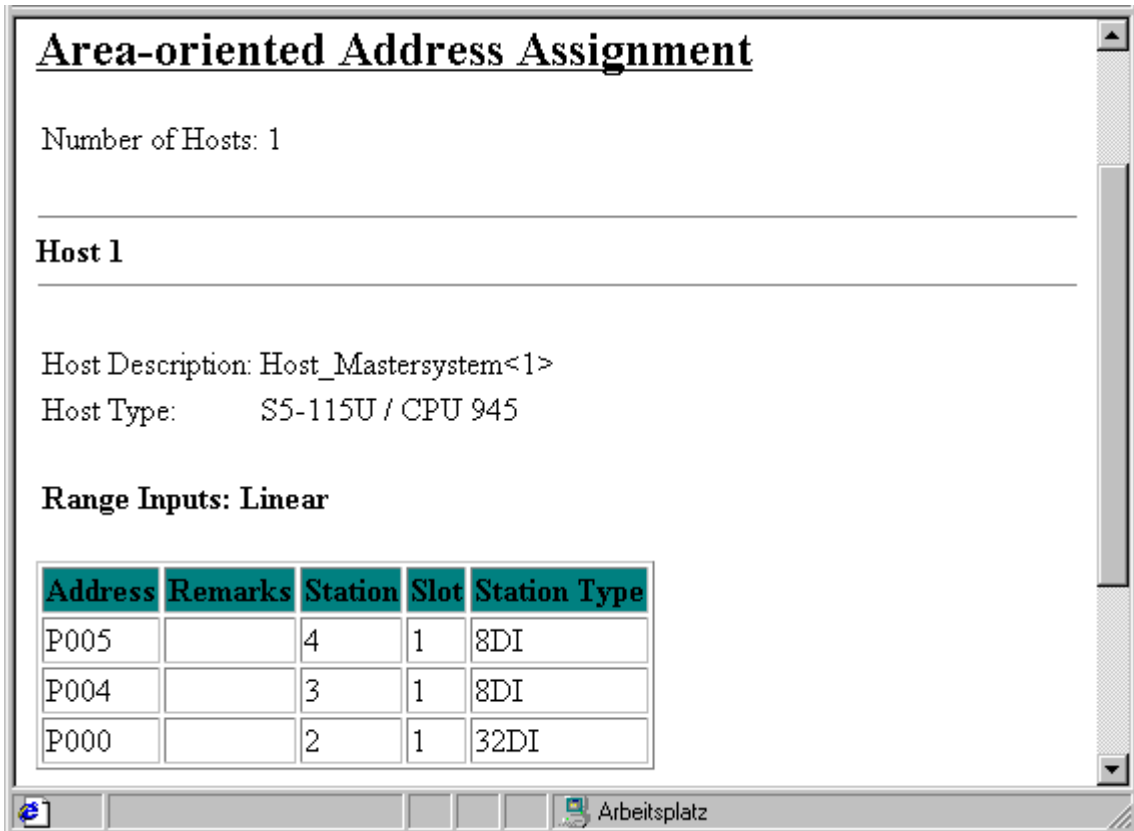



Figure 4-22 The "Area-oriented Address Assignment" overview

Print out the area-oriented address assignment

1. Choose the **File > Print** menu command or .
2. Specify the print properties, and then click "OK".

Result: The "Area-oriented Address Assignment" overview is printed out.

Tip: Note that large configurations can also lead to long printouts.

4.13 Commissioning the programming device/PC online on the bus

To transfer the configuration to the DP masters or to use the DP online (diagnostic) functions described below, you switch COM PROFIBUS online.

Requirements

- The PC/programming device (with a PROFIBUS card) must be connected to the PROFIBUS-DP bus system.
- The PC/programming device interface must be set (see Chapter 2).
- The memory card for the IM 308-C must be parameterized (see Chapter 2).

Switch COM PROFIBUS online/offline

When a DP online function (Section 4.13 to 4.18) is executed, COM PROFIBUS is switched **online automatically**.

To disconnect the programming device/PC from the PROFIBUS bus system again, choose **Service > Switch PG/PC Offline**.

4.14 Transferring (exporting) the configuration to the DP master

COM PROFIBUS exports only the data of one master system to the DP master. In other words, you have to export the configuration data of the relevant master system for each DP master one after the other.

Note

If your bus configuration consists of several master systems and you change the parameterization of a master system, you also have to reparameterize the other masters. Otherwise, there will be problems in the bus system, which may even fail (e.g. due to a change in the response monitoring time).

Requirements

- The programming device/PC (with a PROFIBUS card) must be connected to the PROFIBUS-DP bus system or directly to the DP master.
- The PC/programming device interface must be set (see Chapter 2).
- When the IM 308-C is a DP master, and only then, the memory card must be inserted.

Note

Since the default parameter set (IM 308-C: transmission rate = 19.2 kbps and PROFIBUS address = 1) is stored on the DP master, there must be no other PROFIBUS node with the PROFIBUS address 1 and no other transmission rate must be set.

Transfer the configuration to the DP master

1. Choose the **File > Export > DP Master** menu command or .
2. Specify the PROFIBUS address of the DP master, and then click "OK" (in the example: PROFIBUS address 1).

Result: The "Export DP Master" dialog box appears. COM PROFIBUS suggests a response monitoring time on the basis of the bus configuration and the set transmission rate. You can accept this time or set a longer time.

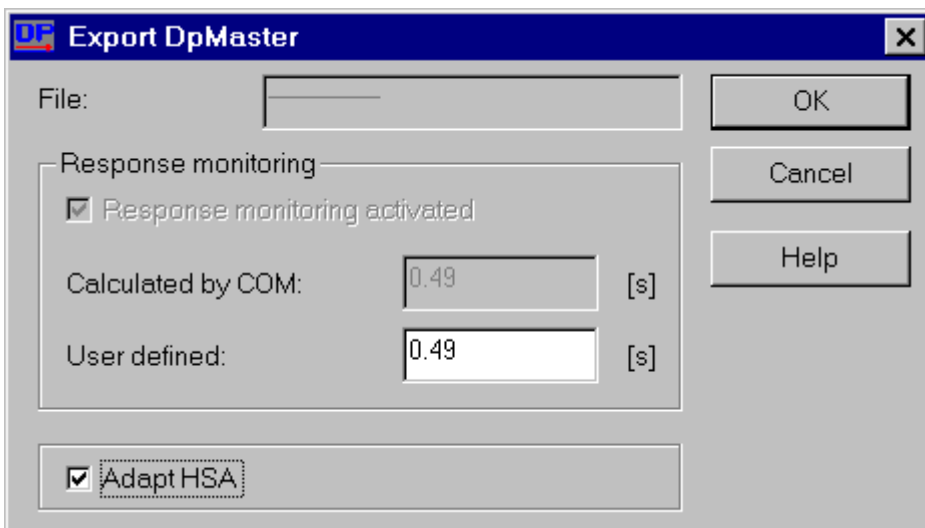

Figure 4-23 The "Export DP Master" dialog box

3. Click "OK" to accept the suggested setting.

Result: A query appears, asking whether the DP master is to be switched to STOP mode.

4. Click "OK" in response to the query.

Result: The DP master switches to STOP mode, regardless of the position of its mode selector. COM PROFIBUS transfers the parameter set to the DP master (IM 308-C: the "RN" and "IF" LEDs come on; the mode of the IM 308-C remains the same). The DP master continues to work with the old parameter set (IM 308-C: the "ST" and "IF" LEDs come on).

COM PROFIBUS then asks whether the transferred parameter set is to be activated immediately in the DP master:

5. If there is only one DP master on the PROFIBUS bus, respond with "Yes" to activate the parameter set.

Or

If there are at least two DP masters on the PROFIBUS bus, respond with "No". Transfer all the configuration data to the individual DP masters, and then activate the configuration data by choosing **Service > Activate Parameter Set**.

Result: The DP master(s) work(s) with the new parameter set.

Note

In the case of the IM 308-C, the parameter set is saved on the memory card. After power off/power on, the IM 308-C always works with the last parameter set transferred.

Transfer the configuration to the IM 308C DP slave

If the IM 308-C DP slave is run exclusively as a DP slave, the master system created by COM PROFIBUS for this IM 308-C must be exported.

Select the lower "S5 115U / CPU 945" icon (PROFIBUS address 5) in the window for the graphical bus configuration (see Figure 4-2) and proceed in exactly the same way as when transferring the configuration to the DP master. Perform steps 2 to 5. Select the PROFIBUS address "5" for the IM 308-C DP slave.

4.15 Assigning a PROFIBUS address

Before you commission the PROFIBUS-DP bus system, you assign the DP slaves their PROFIBUS addresses. The PROFIBUS address of some DP slaves is set by means of a DIL switch on the module. In the case of other DP slaves, the PROFIBUS address can be assigned by means of software. COM PROFIBUS obtains the relevant information from the device master file.

Please refer to the **DP slave manual** to find out how the PROFIBUS address is assigned to the DP slaves and follow the instructions you find there.

Set the PROFIBUS address for the ET 200B and ET 200S

Use the DIL switch to set "2" for the ET 200B and "3" for the ET 200S. You will find the exact procedure described in the ET 200B and ET 200S manuals.

Assigning a PROFIBUS address using COM PROFIBUS

If the PROFIBUS address can be assigned by means of software, proceed as follows:

Requirements

- The programming device/PC (with a PROFIBUS card) must be connected to the PROFIBUS-DP bus system or directly to the DP slave.
- The PC/programming device interface must be set (see Chapter 2).
- The DP slave must comply with the EN 50170, Volume 2, PROFIBUS standard.

- The DP slave must be in its "waiting for parameterization" state (its state after being switched on). The DP slave must not be engaged in data transfer with the DP master.

How to assign a DP slave its PROFIBUS address

1. Select the DP slave in the window for the graphical bus configuration (see Figure 4-2).
2. Choose **Service > Modify PROFIBUS Address**.

Result: The dialog box for changing the PROFIBUS address appears.

3. Enter the old and new PROFIBUS addresses. At initial commissioning, the "old PROFIBUS address" corresponds to the default address of 126.
4. Click "OK" to apply the change and close the dialog box.

Result: COM PROFIBUS assigns the slave a new PROFIBUS address. The slave adopts the new PROFIBUS address immediately.

4.16 Testing the signal states of the individual DP slaves

Before you commission the entire PROFIBUS-DP bus system, we recommend that you check the signal paths of the sensors and actuators connected to the DP slaves. COM PROFIBUS allows you to carry out a signal test for the configured and connected inputs and outputs.

Requirements

- The programming device/PC (with a PROFIBUS card) must be connected to the PROFIBUS-DP bus system.
- The PC/programming device interface must be set (see Chapter 2).
- The CPU must be in STOP mode.

Test the signal conversion

1. Select the DP slave in the window for the graphical bus configuration (see Figure 4-2).
2. Choose the **Service > Observe/Control Inputs/Outputs** menu command or, alternatively, the corresponding command in the pop-up menu for the DP slave (by right-clicking it).

Result: The corresponding dialog box appears. COM PROFIBUS continuously updates the status of the inputs and outputs of the DP slave.

ID	Remarks	I Addr.	O Addr.	Format	Inputs	Outputs
0	4AX	00P212	00P208	KH	0006 0000 0000 0000	0606 0000 0000 0000
1	8DX	00P220	00P216	KH	00	00
2	8DI	00P221		KH	00	
3	2AX	00P222	00P218	KH	0000 0000	0000 0000

Figure 4-24 The "Control" dialog box

3. Start the status display of the slave inputs/outputs by choosing **Status** from the pop-up menu for the inputs/outputs (by right-clicking the table field).
4. Stop the status display by choosing **Stop Updating** from the pop-up menu.
5. After switching with **Control Values** in the pop-up menu, enter new control values in the white fields in the "Outputs" column of the table.
6. Start control of the outputs with the new control values by choosing **Control** from the pop-up menu. The communication between the DP slave and the DP master (class 1) is interrupted. The programming device/PC (master class 2) with COM PROFIBUS is the master for this period.
7. Choose **Stop Updating** from the pop-up menu to terminate the control of the outputs. The connection to the DP master (class 1) is established again.

Note

If there is no DP master (class 1) on the bus, the "Status" function is not available. The "Control" function is not available for the "MPI_ISA_card" PROFIBUS card and for the station types DP/AS-I Link and ET 200L-SC.

4.17 Commissioning the bus configuration

Once you have checked the wiring to the sensors and actuators of the various DP slaves by means of "Observe/Control Inputs/Outputs" (Status/Control) you commission the bus configuration.

Switch on the stations on the PROFIBUS bus

1. Connect all the DP slaves and DP masters with the PROFIBUS bus cable.
2. Switch on the power supplies of the DP slaves.
3. Switch the STOP/RUN switch of the DP slaves, if there is one, to RUN.

4. Switch the mode selector switch of the IM 308-C from OFF or ST to RN.
5. Switch on the power supply of the base units.

Result: The IM 308-C starts up (BF (bus fault) LED flashes) and transfers the slave parameters entered in COM PROFIBUS to the DP slaves.

The IM 308-C then compares the configuration created using COM PROFIBUS with the actual configuration.

The BF LEDs of the connected DP slaves must go off. If there is data transfer between all the configured DP slaves and the IM 308-C, the BF LED of the IM 308-C also goes off.

6. Use COM PROFIBUS to check the diagnostic messages (see Section 4.17). In this way you can check whether user data transfer to the DP slaves is working.
7. If appropriate, restart the CPU.

You will find more information on commissioning the IM 308-C as a DP master in the *ET 200 Distributed I/O System* manual.

4.18 Evaluating a diagnosis with COM PROFIBUS

The diagnostic overview indicates which DP slave has detected a malfunction and reports a slave diagnosis. The slave diagnosis provides detailed device-specific diagnostic information.

Requirements

- The programming device/PC (with a PROFIBUS card) must be connected to the PROFIBUS-DP bus system.
- The PC/programming device interface must be set (see Chapter 2).
- The CPU must be in STOP mode.

Display the diagnostic overview

1. Choose **Service > Diagnostic Overview**.

Result: The "Overview Diagnostics" dialog box appears.

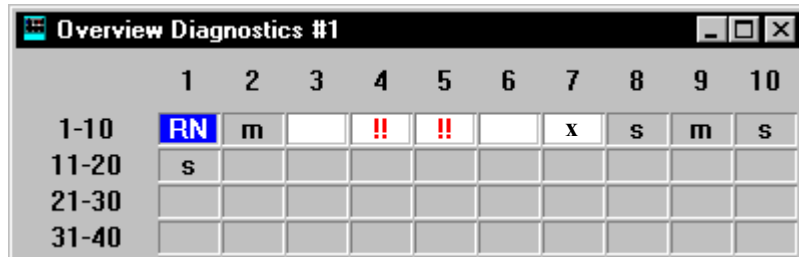





Figure 4-25 The "Overview Diagnostics" dialog box

The diagnostic overview displays the following:

- RN** DP master of the master system with an indication of the master status. The master status indicates the current mode of the master: RN=RUN, CL=CLEAR or ST=STOP
-  DP slave that belongs to the master system and is configured and parameterized by the DP master. There are no diagnostic messages for it.
-  There is a slave diagnosis for this DP slave. You can display it in plain text by using the pop-up menu for the cell (which you access by right-clicking the cell).
-  There is no user data transfer with this DP slave. The DP slave is no longer on the bus or the slave has a configuration error (e.g. because a module has been removed).
- s** DP slave that does not belong to the master system but that has been configured using COM PROFIBUS in a different master system of the bus configuration.
- m** DP master that does not belong to the master system but that has been configured using COM PROFIBUS in a different master system of the bus configuration.
- m+s** DP master that does not belong to the master system but that has been configured using COM PROFIBUS in a different master system of the bus configuration and that also functions as a DP slave in another master system (e.g. the IM 308-C as a DP slave).
- x** DP Slave that belongs to the master system but was not configured with COM PROFIBUS

Result: If you move the mouse pointer over a cell in the "Overview Diagnostics" dialog box, the status of the DP master or DP slave is displayed in plain text in the status bar of COM PROFIBUS.

Display the slave diagnosis

1. Select the diagnostic overview (see above).
2. Right-click a DP slave on which diagnostic data is available, and then choose **Slave Diagnosis** from the pop-up menu that appears.
3. Specify whether you want to request the slave diagnosis from the DP master or directly from the DP slave, and then click OK.

Result: The slave diagnostics mode dialog box appears.

Result: The "Slave Diagnostics" dialog box with plain-text slave-specific diagnostic information appears.

4. Click the  button on the toolbar.

Result: The slave diagnosis is printed.

Example:

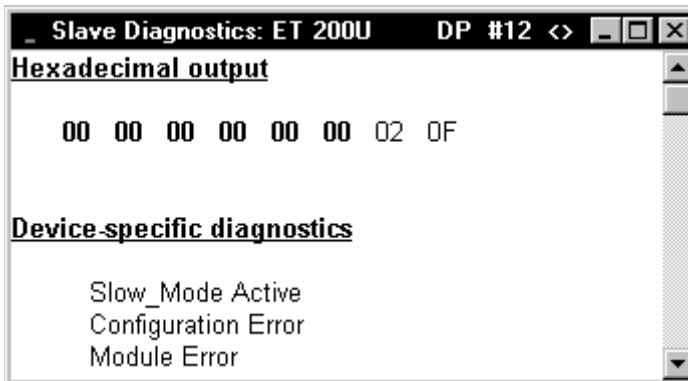

Figure 4-26 The "Slave Diagnostics" display window

5 PROFIBUS-FMS configuration example

Purpose of the example

This chapter describes a complete FMS configuration with COM PROFIBUS.

The configuration example is intended to show you how to proceed when configuring an FMS master system using COM PROFIBUS. The sequence in which the steps appear here is recommended rather than absolutely necessary.

Sample structure of an FMS configuration

The following PROFIBUS devices are used in the example described below:

- The CP 5412 (A2) as an FMS master
- The S7-300 with the CP 343-5 as an FMS station
- The ET 200U DP/FMS as an FMS station

Transmission method

RS 485 transmission method for electrical networks on the basis of shielded twisted-pair cables

Network components

No additional network components such as OLMs, RS 485 repeaters, etc.

Bus protocol

PROFIBUS-FMS: This bus protocol applies when there are FMS masters based on the EN 50170, Volume 2, PROFIBUS standard on the bus.

PROFIBUS-DP and PROFIBUS-FMS use the same transmission technology and standardized bus access methods and can therefore run simultaneously on a single cable.

5.1 Starting configuration

Start COM PROFIBUS

From the Windows Start menu, choose:

Start > Programs > Siemens COM PROFIBUS > COM PROFIBUS

Result: The COM PROFIBUS user interface appears and a default program file is created.

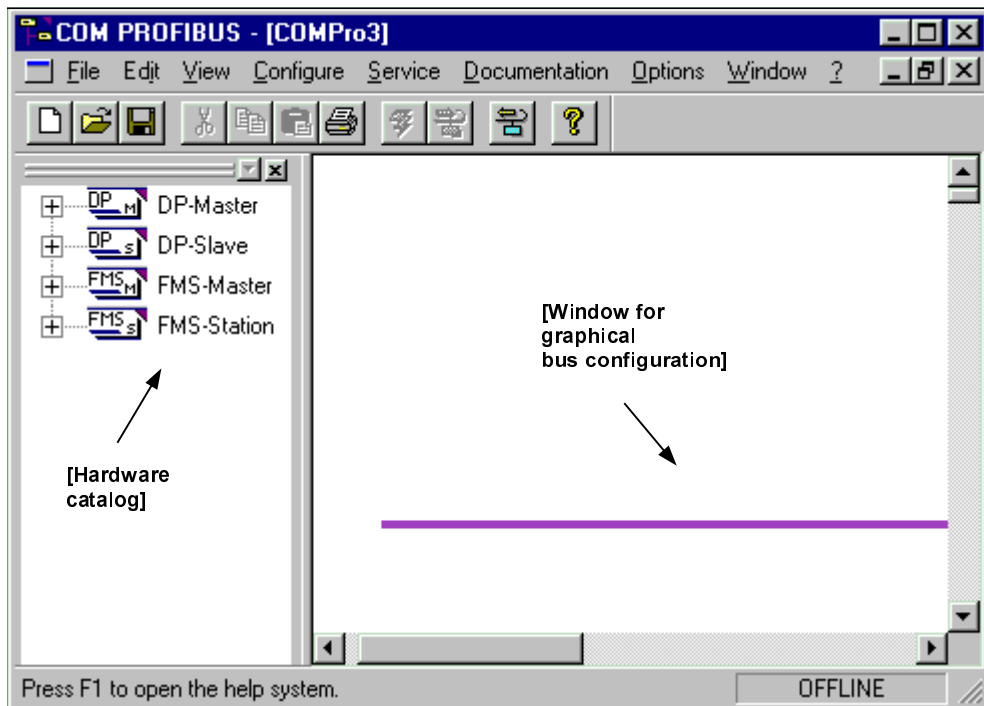

Figure 5-1 Configuration with COM PROFIBUS

Read in the device master files

Choose the **File > Read in GSD Files** menu command.

Result: All the configurable bus nodes are displayed in the hardware catalog.

Note

You only need to execute this function when a new device master file is copied to COM PROFIBUS's ...\\fmsgsd subdirectory or an existing device master file in the subdirectory is changed **after** the program is started up.

5.2 Setting up the bus configuration

You begin configuration by selecting and arranging the FMS masters and FMS stations in the window for the graphical bus configuration. Not until you have created all the PROFIBUS nodes do you begin setting the parameters.

Several masters on the bus

The configuration for a master system is shown below. If there are several DP masters on the bus, you can use the **View > Network View** and **View > FMS** menu commands to switch between the view of the whole bus and the view of a master system during configuration.

Set up the bus configuration graphically

Select the FMS master and the associated FMS stations from the hardware catalog, and drag and drop the modules one after the other to move them to the window on the right for the graphical bus configuration (see Figure 5-1).

Tip 1: Double-click the modules in the catalog to set up the configuration more quickly.

Tip 2: Press <+> and <-> on the numeric keypad to open and close the entire catalog.

Select the following modules from the hardware catalog for the sample configuration:

```
FMS master > CP 5412 (A2)
FMS station > S7-300 CP343-5 FMS
FMS station > ET 200U DP/FMS
```

Result: The bus configuration is created with icons for all the modules (without text)

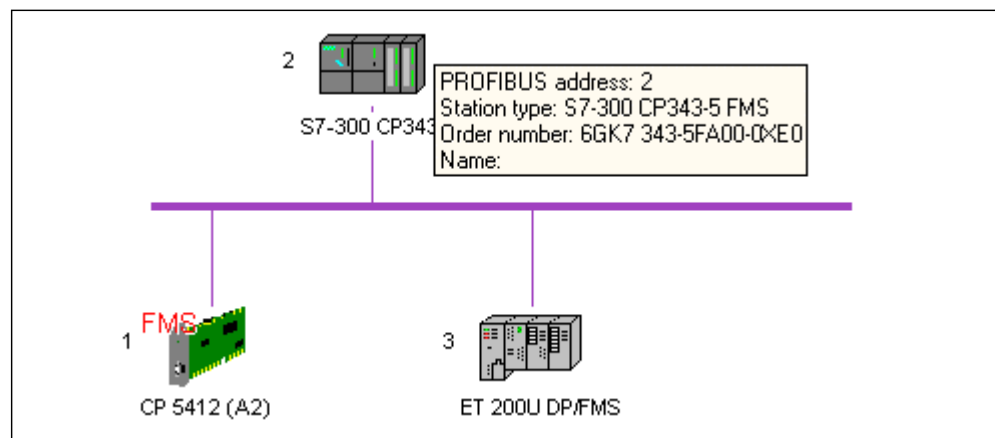

Figure 5-2 Sample structure of an FMS configuration

5.3 Entering bus parameters

Once you have set up the bus configuration graphically, you begin parameterization. The bus parameters apply to the entire PROFIBUS bus system.

Enter the bus parameters

1. Choose **Configure > Set Bus Parameters**.

Result: The "Bus Parameters" dialog box appears.

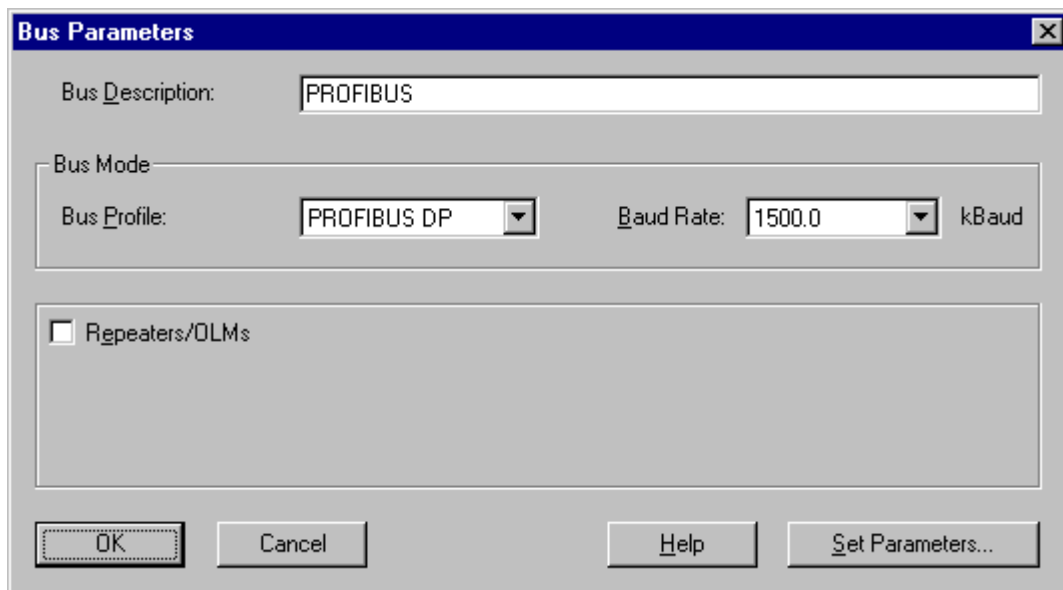

Figure 5-3 The "Bus Parameters" dialog box

2. Select the "Standard" bus profile.

"Standard" applies in the case of multimaster operation with fast bus nodes, which also include the SIMATIC NET PC module CP 5412 (A2). The bus profiles are default sets of bus parameter settings for different PROFIBUS applications. Each bus profile contains the PROFIBUS bus parameters calculated and set by COM PROFIBUS for a specific configuration, profile and transmission rate.

Tip: You can click the "Set Parameters" button to view the bus parameters calculated by COM PROFIBUS. The calculated bus parameters can only be changed if the "Adjustable" bus profile is selected.

3. Select a transmission rate of 1500.0 kbps.

The transmission rate set here applies to the entire PROFIBUS bus system. In other words, all nodes on the PROFIBUS bus system must support the selected transmission rate.

4. Click "OK" to apply the bus parameters and exit the dialog box.

Result: The bus parameters are saved.

Repeaters/OLMs

If there are RS 485 repeaters in electrical networks or OLMs/OBTs in optical networks on the PROFIBUS-DP bus system, select the "Repeater/OLMs" check box. The number of network components to be specified and the cable lengths are taken into account by COM PROFIBUS when calculating the bus parameters.

Note

The network components configured **in the network view** of COM PROFIBUS have no effect on the bus times calculated. If these network components are to be taken into account, you must increase the number for "Repeaters/OLMs" in the "Bus parameters" dialog box.

Change the bus parameters individually (optional)

Normally - i.e. when the FMS masters are configured with COM PROFIBUS - you do not need to change the default bus parameter settings in the bus profile.

However, if you do want to adapt the bus parameters yourself and have the required PROFIBUS expertise, select the "Adjustable" bus profile and then click the "Set Parameters" button. In the "Bus Parameters" dialog box that appears you can adapt the bus parameters yourself to suit your bus configuration. Please look up the information on this in the **online help system** ("Help" button).

Note

Always set the slowest bus time of all bus nodes.

All the values for the bus parameters are specified in the unit t_{bit} (bit time). The bit time depends on the transmission rate and is calculated using the following formula: $t_{\text{bit}} [\mu\text{s}] = 1/\text{transmission rate [1000 kbps]}$.

Table 5-1 Bit time depending on the transmission rate

Transmission rate	$t_{\text{bit}} [\mu\text{s}]$
9.6 kbps	104.167
19.2 kbps	52.083
93.75 kbps	10.667
187.5 kbps	5.333
500 kbps	2.000
1500 kbps	0.667

Target rotation time "Ttr"

The bus parameter "Ttr" calculated by COM PROFIBUS and shown here does not represent the real target rotation time; it represents a maximum permitted value and thus cannot be used to determine response times on the PROFIBUS bus system.

5.4 Entering master parameters

You use the master parameters to specify the PROFIBUS address of the CP 5412 (A2). From here you also start the configuration of the FMS connections to the FMS stations.

Enter the master parameters

1. Double-click the "FMS master: CP 5412 (A2)" icon in the window for the graphical bus configuration (see Figure 5-2).

Result: The "FMS master parameters" dialog box appears.

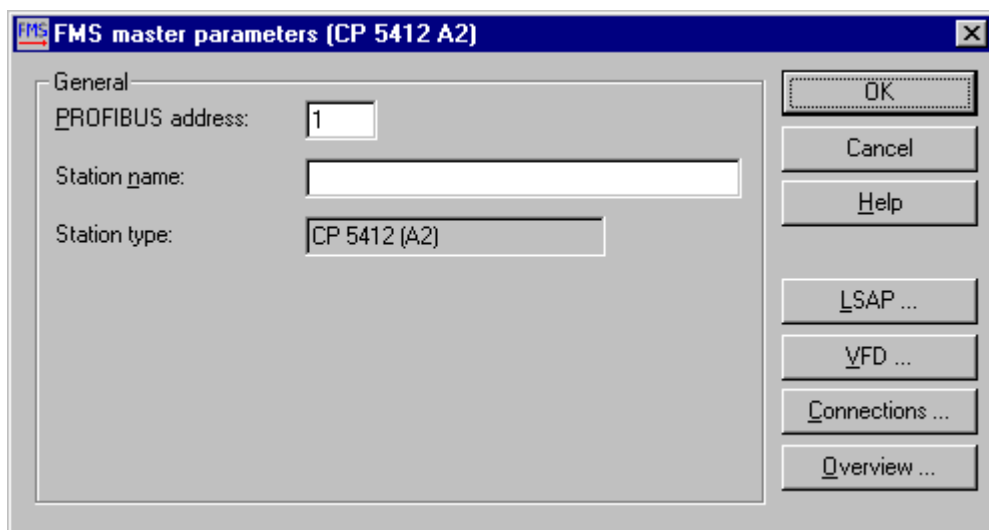

Figure 5-4 The "FMS master parameters" dialog box

2. Set the PROFIBUS address for the CP 5412 (A2):

Parameter	Value
PROFIBUS address	Keep "1"

Further support: Please also note the information on the master parameters in the **online help system** ("Help" button).

Reserve the LSAPs

Local service access points (LSAPs) that cannot be used simultaneously by other protocols are used at the FDL interface of the CP 5412 (A2). If you use several protocols simultaneously, you have to disable in COM PROFIBUS those LSAPs that are used by the FDL protocol.

1. Click the "LSAP" button in the "FMS master parameters" dialog box.

Result: The "Reserve LSAP" dialog box appears. All the LSAPs used for PROFIBUS are grayed out and can no longer be selected.

2. Reserve the LSAPs for FDL:



LSAPs that are used by the FDL protocol (must be set by you)



LSAPs that are still unused



LSAPs that are used by PROFIBUS-FMS (unchangeable)

3. Click "OK" to apply the LSAP reservations and exit the dialog box.

Edit the VFDs

Each time an FMS master is configured, COM PROFIBUS automatically creates a virtual field device (VFD). You can edit the properties of the VFD and create other VFDs for the CP 5412 (A2).

1. Click the "FVD" button in the "FMS master parameters" dialog box.

Result: The "Edit VFD" dialog box appears. "VFD list" contains all the VFDs configured so far. If you select a VFD, the properties that can be set for the VFD are displayed in the "Edit selected VFD" area. You can create VFDs by clicking the "New" button.

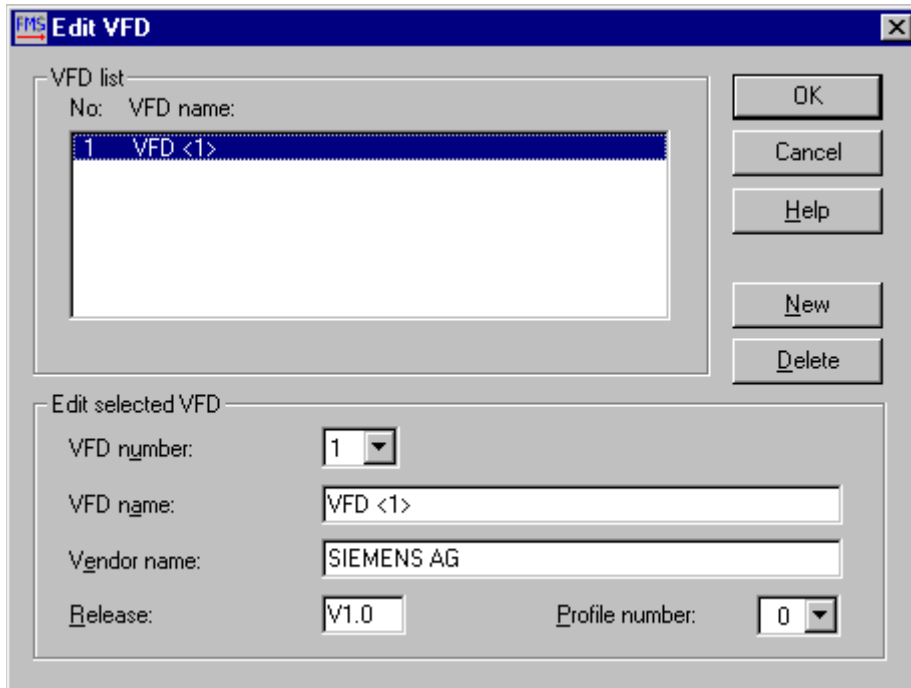

Figure 5-5 The "Edit VFD" dialog box

2. Click "OK" to accept the default properties of the VFD for the sample configuration and exit the dialog box.

Further support: Please also note the information on the VFD properties in the **online help system** ("Help" button).

Note

At least one VFD must be configured. In other words, it is not possible to delete the last VFD. If an FMS connection references a VFD that is to be deleted, COM PROFIBUS outputs a warning to this effect.

The "Connections" button

The "Connections" button allows you to configure the FMS connections to the FMS stations. We recommend that you begin by parameterizing the FMS stations and then define the FMS connections, as in the example.

For information on the dialog box for specifying the FMS connections, refer to Section 5.6.

5.5 Entering station parameters for the S7-300 CP 343-5 FMS

For the FMS stations you only need to check the PROFIBUS addresses and, if necessary, change them. No further settings are required.

For the sample configuration we accept the default PROFIBUS address "2" for the FMS station S7-300 CP 343-5 FMS.

How to change the PROFIBUS address of an FMS station

1. Double-click the "S7-300 CP343-5 FMS" icon in the window for the graphical bus configuration (see Figure 5-2).

Result: The "FMS station parameters" dialog box appears.

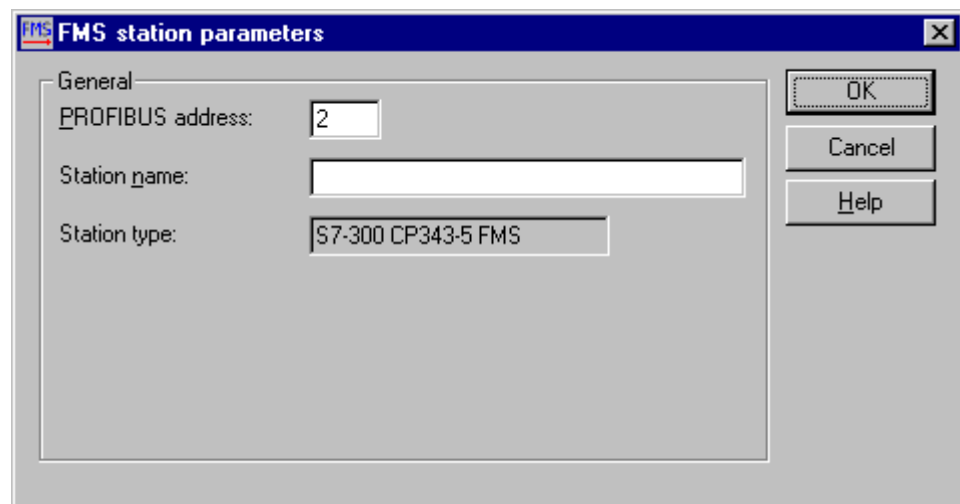

Figure 5-6 The S7-300 CP 343-5 FMS "Station parameters" dialog box

2. Change the PROFIBUS address of the FMS station.
3. Click "OK" to accept the setting and close the dialog box.

Further support: Please also note the information on the FMS station parameters in the **online help system** ("Help" button).

5.6 Setting FMS connections to the S7-300 CP 343-5 FMS

Now that you have parameterized FMS masters and FMS stations, you define the FMS connections. COM PROFIBUS allows you to create, modify and delete FMS connections to FMS stations.

Create the FMS connections

1. Double-click the icon for the FMS master "CP 5412 (A2)" in the window for the graphical bus configuration (see Figure 5-2).

- Click the "Connections" button in the "FMS master parameters" dialog box.

Result: The "Edit FMS connections" dialog box appears. The "Connections" list displays all the configured FMS connections to all the FMS stations. If you select an FMS connection, the parameters that can be set for the FMS connection are displayed in the lower part of the dialog box. You can create FMS connections by clicking the "New" button.

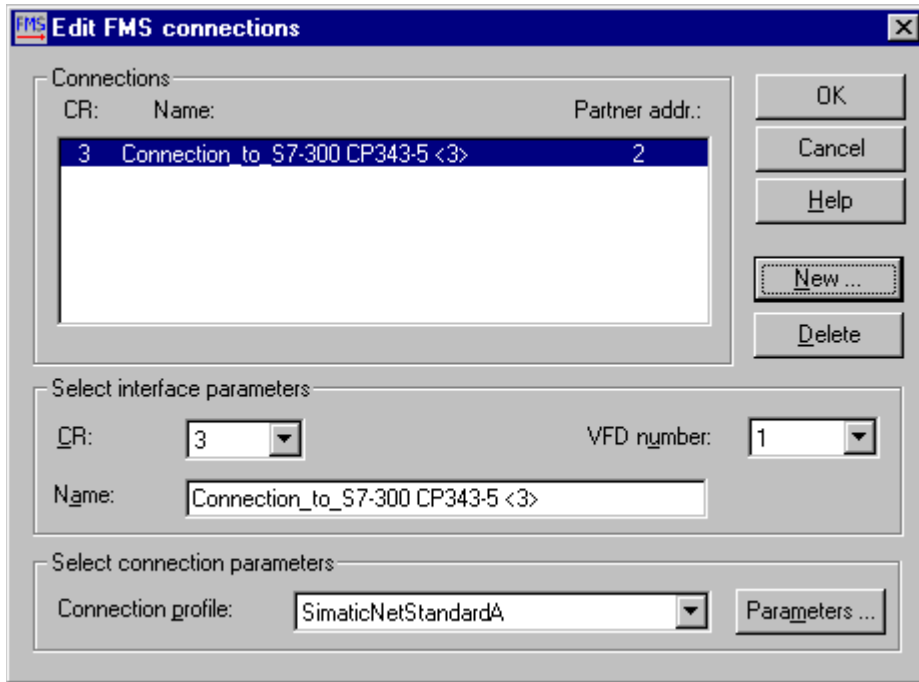

Figure 5-7 The S7-300 CP 343-5 FMS "Edit FMS connections" dialog box

- Click the "New" button.

Result: The "FMS partner station" dialog box appears. The possible connection partners are listed here for you to select, identified by their PROFIBUS address and station name (or station type, if there is no station name available).

- Select "2 / S7-300 CP 343-5 FMS", and then click "OK".

Result: We have created an FMS connection to the S7-300 CP 343-5 FMS with the PROFIBUS address "2" (see the figure above).

- Retain the default settings of the FMS connections under "Select interface parameters" and "Select connection parameters" for the following:
 - VFD number: The FMS connection is assigned to a configured VFD here. In our example there is only one VFD with the number "1" (see Figure 5-5).

- Connection profile: The specific communication parameters of an FMS station are grouped together in the connection profile. COM PROFIBUS obtains the permissible connection profiles from the device master file. You can display and, if necessary, change the specific communication parameters by means of the "Parameters" button (this is described in the paragraphs that follow).

Further support: Please also note the information on the interface parameters and connection parameters in the **online help system** ("Help" button).

Set the communication parameters of the FMS connections

The settings of the communication parameters and services described below must be checked and, if necessary, changed for **each** FMS connection.

1. In the "Edit FMS connections" dialog box, select the FMS connection "Connection_to_S7-300 CP343-5 <3>" and then click the "Parameters" button.

Result: The "FMS connection - communication parameters" dialog box appears. Here you specify the communication type and the LSAPs.

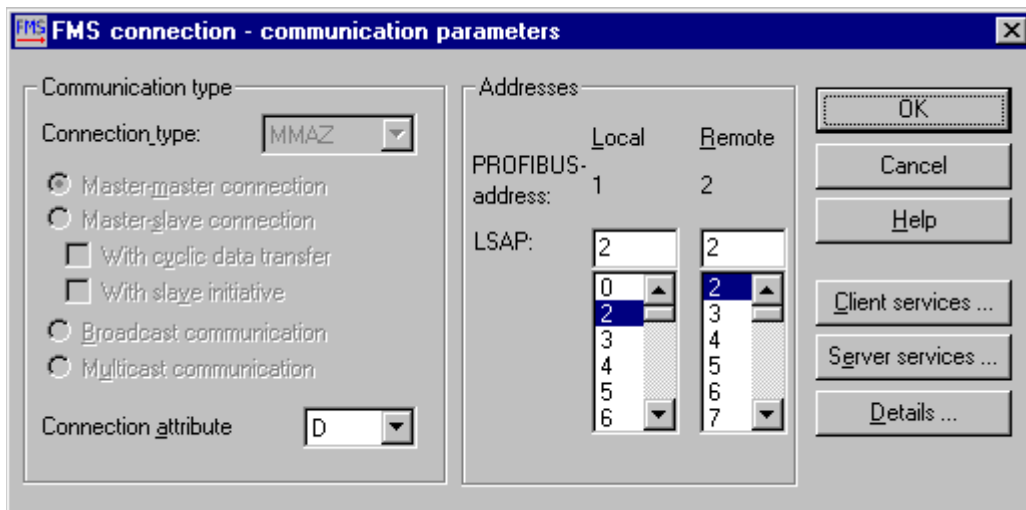

Figure 5-8 The S7-300 CP 343-5 FMS "FMS connection - communication parameters" dialog box

2. Set the communication parameters:

Parameter	Value
Connection type	"MMAZ" (unchangeable)
Master-master connection	"Without slave initiative" (unchangeable)
Connection attribute	Keep "D"
LSAP	Keep local="2", remote="2"

- Connection type: When you select the connection type, you determine which communication services are available. COM PROFIBUS obtains the permissible connection types from the device master file of the connection partner. The radio buttons under "Connection type" indicate the meaning of the connection type (see also the section below entitled "Connection types"). "MMAZ" is preset as the connection partner for the S7-300 CP343-5 FMS.
- Connection attribute: The connection attribute specifies whether the FMS connection contains a definite (D = Definite Connection) or indefinite (I = Indefinite Connection) connection end point. "D" (D = Definite Connection) is kept for the S7-300 CP343-5 FMS.
- LSAP: The value "2" is kept as the LSAP for both the CP 5412 (A2) (local) and the FMS station S7-300 CP343-5 FMS (remote).

Further support: Please also note the information on the various communication parameters in the **online help system** ("Help" button).

Note

The same connection type must be set for both communication partners of the FMS connection.

Connection types

The following table shows the connection types of the FMS connections and the possible request types.

Table 5-2 Assignment of connection type to request type

Connection type	Request type	
<p>MMAZ</p>	<p>Master-master with acyclical connection: Writing, reading and reporting possible in both directions</p>	
<p>MSAZ</p>	<p>Master-slave with acyclical connection: Writing, reading and reporting is possible from the FMS master</p>	

MSAZ_SI	<p>Master-slave with acyclical connection and slave initiative*: Writing, reading and reporting is possible from the FMS master. The FMS slave can also report if the master has granted it the appropriate authorization to send.</p>	
MSZY	<p>Master-slave with cyclical connection: Writing, reading and reporting is possible from the FMS master.</p>	
MSZY_SI	<p>Master-slave with cyclical connection and slave initiative*: Writing, reading and reporting is possible from the FMS master. The FMS slave can also report if the master has granted it the appropriate authorization to send.</p>	
BRCT	<p>Broadcast A broadcast is sent to all.</p>	
MULT	<p>Multicast A multicast is sent to several.</p>	
<p>* The slave initiative (SI) specifies that the slave can initiate requests on this connection itself.</p> <p>—▶ Confirmed request - -▶ Unconfirmed request [Grey Box] Client function [White Box] Server function</p>		

Check the client and server services

1. In the "FMS connection - communication parameters" dialog box, click the "Client services" or "Server services" button.

Result: The "FMS connection - services (client)" or "FMS connection - services (server)" dialog box appears.

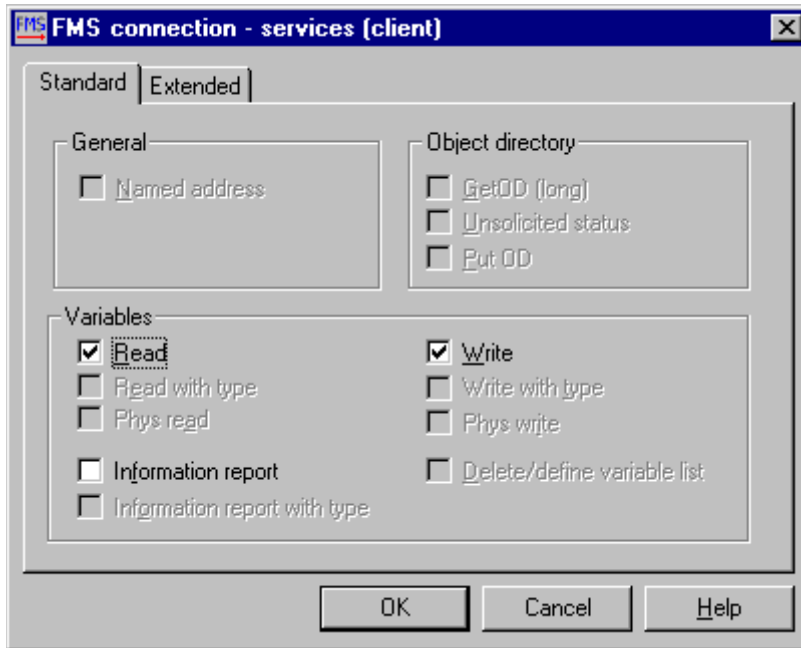

Figure 5-9 The S7-300 CP 343-5 FMS "FMS connection - services (client)" dialog box

2. Check the services and, if necessary, modify them (e.g. click "Information report"):
 - Client services: Services that are to be used by the FMS master as a client on the selected FMS connection (e.g. when the FMS master wants to send read requests to the FMS station via the FMS connection).
 - Server services: Services that are to be used by the FMS master as a server on the selected FMS connection (e.g. when the FMS master wants to receive read requests from the FMS station via the FMS connection).
3. Click "OK" to accept the settings and close the dialog box.

Further support: Please also read the description of each service in the **online help system** ("Help" button).

Note

An FMS connection is only set up when the connection partners support the same services (client - server). For this reason you can change services here in order to adjust them to the level of the weaker communication partner.

Specify the details of the FMS connection

1. In the "FMS connection - communication parameters" dialog box, click the "Details" button.

Result: The "FMS connection - details" dialog box appears. Here you can set other, seldom used parameters for an FMS connection. You normally do not need to change the default parameters displayed. These parameters are dependent on the connection profile and described in the PROFIBUS standard.

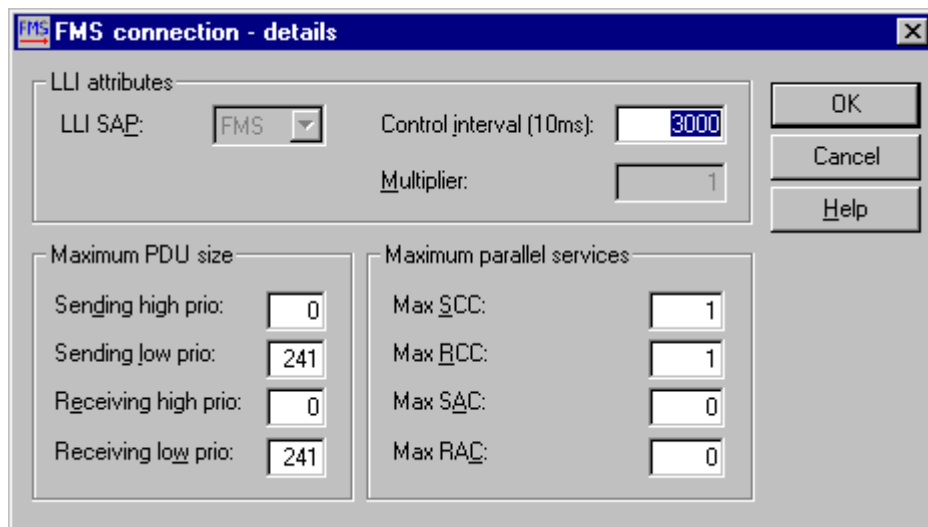

Figure 5-10 The S7-300 CP 343-5 FMS "FMS connection - details" dialog box

2. Change the details of the FMS connection, if necessary.
 - LLI attributes: LLI stands for lower layer interface. This interface establishes the connection between the FMS user interface and the underlying FDL services. You use the LLI attributes to specify the interface to the application layer (FMS in the case of the CP 5412 (A2)) and the properties of the LLI.
 - Maximum PDU size: Maximum possible lengths of the high-priority and low-priority protocol data units (PDUs) in the sending and receiving directions.
 - Maximum parallel services: The maximum parallel services affect the memory requirements on the CP 5412 (A2). Higher values require more memory but also increase the throughput rate.

3. Click "OK" to accept the settings and close the dialog box.

Result: The connection parameters for the connection to the S7-300 CP 343-5 FMS have now all been set.

Note

An FMS connection is not set up unless the settings specified here for the details match those of the communication partner.

Further support: Please also read the description of the communication parameters in the **online help system** ("Help" button).

5.7 Entering station parameters for the ET 200U DP/FMS

For the FMS stations, you only need to check the PROFIBUS addresses and, if necessary, change them. No further settings are required.

For the sample configuration we accept the default PROFIBUS address "3" for the FMS station ET 200U DP/FMS.

How to change the PROFIBUS address of an FMS station

1. Double-click the "ET 200U DP/FMS" icon in the window for the graphical bus configuration (see Figure 5-2).

Result: The "FMS station parameters" dialog box appears.

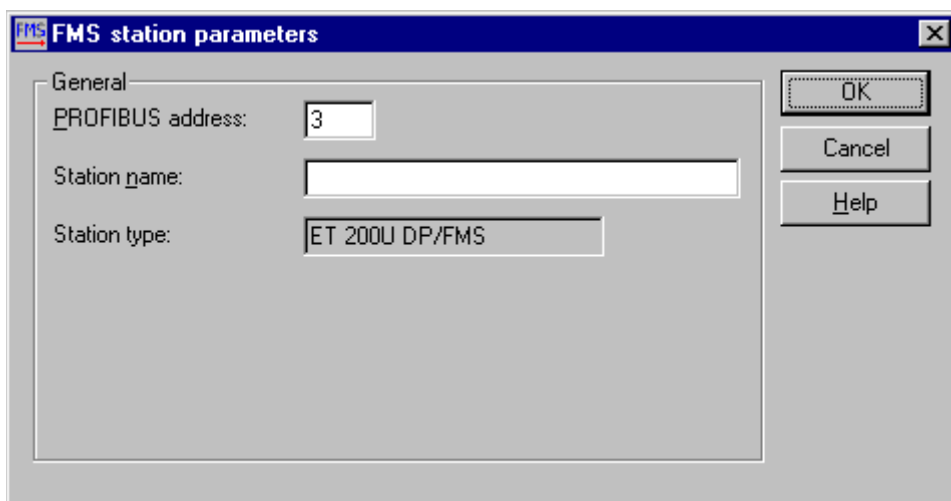

Figure 5-11 The ET 200U DP/FMS station parameters dialog box

2. Change the PROFIBUS address of the FMS station.
3. Click "OK" to accept the setting and close the dialog box.

Further support: Please also note the information on the FMS station parameters in the **online help system** ("Help" button).

5.8 Setting FMS connections to the ET 200U DP/FMS

Now that you have parameterized FMS masters and FMS stations, you define the FMS connections. COM PROFIBUS allows you to create, modify and delete FMS connections to FMS stations.

Create the FMS connections

1. Double-click the FMS master "CP 5412 (A2)" icon in the window for the graphical bus configuration (see Figure 5-2).
2. Click the "Connections" button in the "FMS master parameters" dialog box.

Result: The "Edit FMS connections" dialog box appears. The "Connections" list displays all the configured FMS connections to all the FMS stations. If you select an FMS connection, the parameters that can be set for the FMS connection are displayed in the lower part of the dialog box. You can create FMS connections by clicking the "New" button.

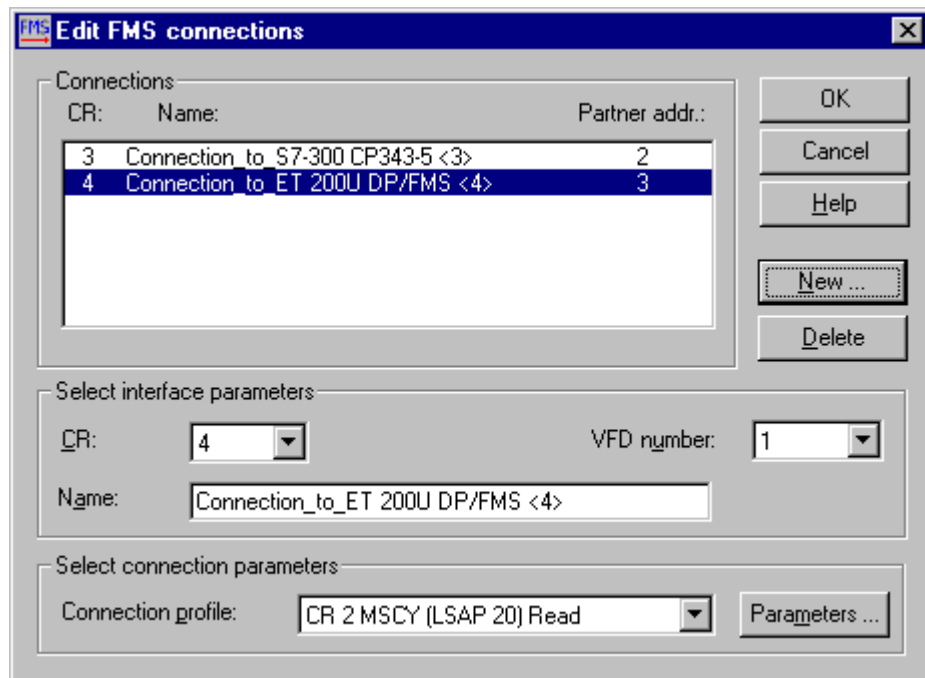

Figure 5-12 The ET 200U DP/FMS "Edit FMS connections" dialog box

3. Click the "New" button.

Result: The "FMS partner station" dialog box appears. The possible connection partners are listed here for you to select, identified by their PROFIBUS address and station name (or station type, if there is no station name available).

4. Select "2 / ET 200U DP/FMS", and then click "OK".

Result: We have created an FMS connection to the ET 200U DP/FMS with the PROFIBUS address "3" (see the figure above).

5. Retain the default settings of the FMS connections under "Select interface parameters" and "Select connection parameters" for the following:

- VFD number: The FMS connection is assigned to a configured VFD here. In our example there is only one VFD with the number "1" (see Figure 5-5).
- Connection profile: The specific communication parameters of an FMS station are grouped together in the connection profile. COM PROFIBUS obtains the permissible connection profiles from the device master file. You can display and, if necessary, change the specific communication parameters by means of the "Parameters" button (this is described in the paragraphs below).

Further support: Please also note the information on the interface parameters and connection parameters in the **online help system** ("Help" button).

Set the communication parameters of the FMS connections

The settings of the communication parameters and services described below must be checked and, if necessary, changed for **each** FMS connection.

1. In the "Edit FMS connections" dialog box, select the FMS connection "Connection_to_ET 200U DP/FMS" and then click the "Parameters" button.

Result: The "FMS connection - communication parameters" dialog box appears. Here you specify the communication type and the LSAPs.

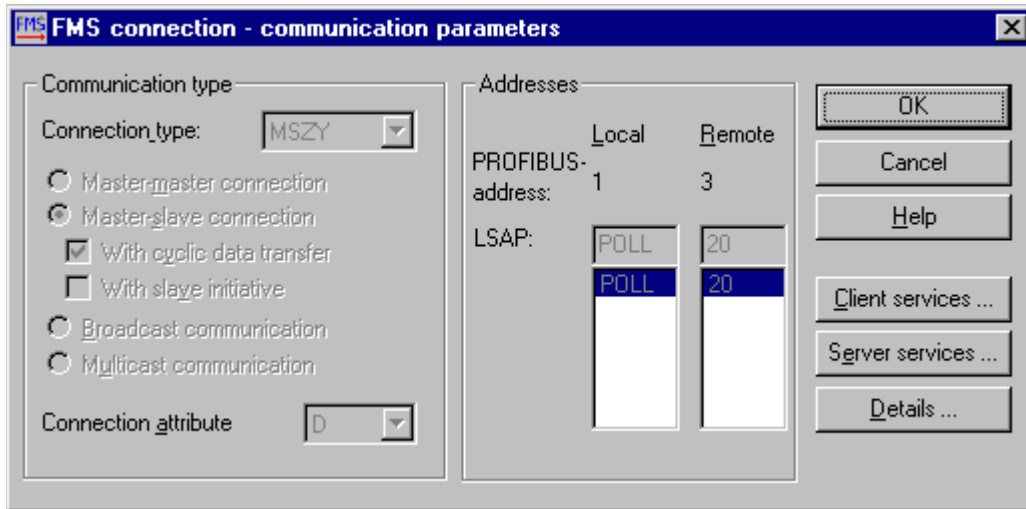

Figure 5-13 The ET 200U DP/FMS "FMS connection - communication parameters" dialog box

2. Set the communication parameters:

Parameter	Value
Connection type	"MSZY" (unchangeable)
Master-slave connection	"With cyclical data interchange" (unchangeable)
Connection attribute	"D" (unchangeable)
LSAP	Local "POLL", remote "20" (unchangeable)

- Connection type: When you select the connection type, you determine which communication services are available. COM PROFIBUS obtains the permissible connection types from the device master file of the connection partner. The radio buttons under "Connection type" indicate the meaning of the connection type (see also the section below entitled "Connection types"). "MSZY" is preset as the connection partner for the ET 200U DP/FMS.
- Connection attribute: The connection attribute specifies whether the FMS connection contains a definite (D = Definite Connection) or indefinite (I = Indefinite Connection) connection end point. "D" is preset for the ET 200U DP/FMS.
- LSAP: The POLL list SAP is set as the LSAP for the CP 5412 (A2) (local), and the value "20" is preset for the FMS station ET 200U DP/FMS (remote).

Further support: Please also note the information on the various communication parameters in the **online help system** ("Help" button).

Note

The same connection type must be set for both communication partners of the FMS connection.

Connection types

See table 5-2

Check the client services

1. In the "FMS connection - communication parameters" dialog box, click the "Client services" button.

Result: The "FMS connection - services (client)" dialog box appears.

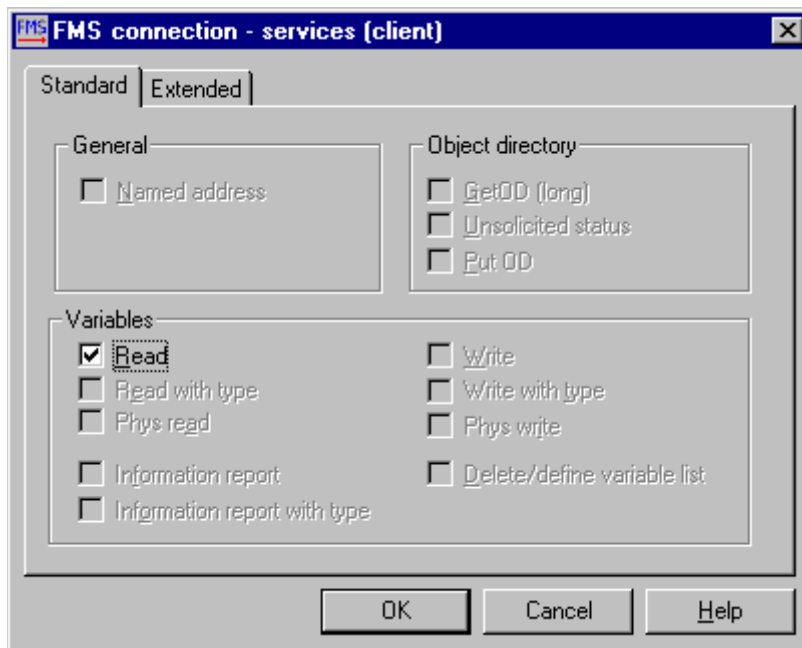

Figure 5-14 The ET 200U DP/FMS "FMS connection - services (client)" dialog box

2. You can view the client services supported here. In the case of the ET 200U DP/FMS, the CP 5412 (A2) can send read requests via the FMS connection.
3. Click "OK" to accept the settings and close the dialog box.

Further support: Please also read the description of each service in the **online help system** ("Help" button).

Specify the details of the FMS connection

1. In the "FMS connection - communication parameters" dialog box, click the "Details" button.

Result: The "FMS connection - details" dialog box appears. Here you can set other, seldom used parameters for an FMS connection. You normally do not need to change the default parameters displayed. These parameters are dependent on the connection profile and the selected services and described in the PROFIBUS standard.

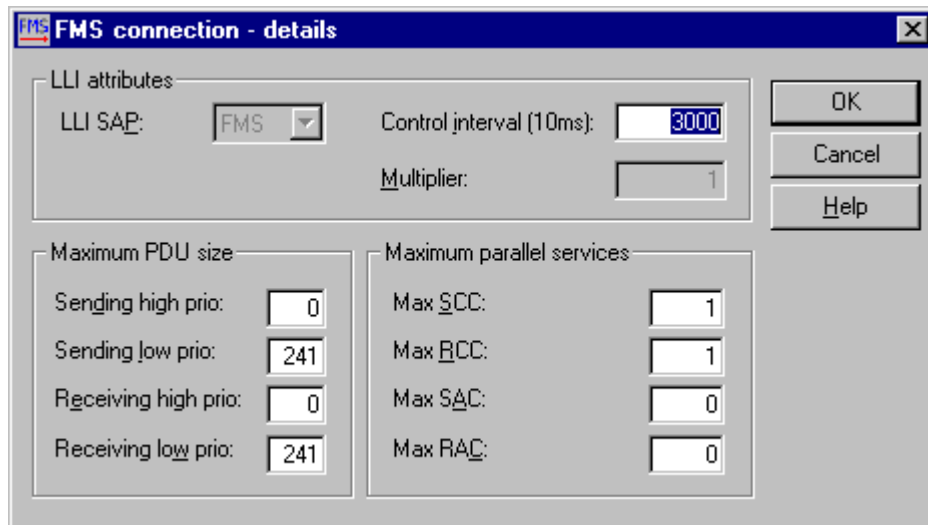

Figure 5-15 The ET 200U DP/FMS "FMS connection - details" dialog box

2. Change the details of the FMS connection, if necessary.
 - LLI attributes: LLI stands for lower layer interface. This interface establishes the connection between the FMS user interface and the underlying FDL services. You use the LLI attributes to specify the interface to the application layer (FMS in the case of the CP 5412 (A2)) and the properties of the LLI.
 - Maximum PDU size: Displays the maximum possible lengths of the high-priority and low-priority protocol data units (PDUs) in the sending and receiving directions.
 - Maximum parallel services: No parallel services possible.
3. Click "OK" to accept the settings and close the dialog box.

Result: The connection parameters for the connection to the ET 200U DP/FMS have now all been set.

Note

An FMS connection is not set up unless the settings specified here for the details match those of the communication partner.

Further support: Please also read the description of the communication parameters in the **online help system** ("Help" button).

5.9 Saving the configuration

Our example is now fully configured. The configuration data has to be saved in a program file.

Save the configuration

1. Choose the **File > Save as** menu command or .
2. Enter a file name with the extension *.pb5, and then click "OK".

Result: The completed bus configuration is saved in the program file. You can export the configuration data to the FMS masters.

5.10 Documenting and printing the configuration

You can use the **Documentation** menu to obtain a variety of information on the parameterized bus configuration. You can, for example, display an overview indicating which FMS stations are on the PROFIBUS bus (with their PROFIBUS addresses) or which FMS connections have been configured. You can print out any overview you have displayed.

In the following we display **by way of example** the connection overview (FMS) in order to check the properties of the configured FMS connections.

Further support: Please also refer to the detailed description of all the documentation options in the **online help system** (look under "Documentation").

Display the connection overview (FMS)

1. Choose **Documentation > Connection Overview (FMS)**.
Result: The "Connection overview (FMS)" dialog box appears.
2. Select the relevant FMS stations.

Result: The connection overview (FMS) of the FMS stations is displayed to you as follows:

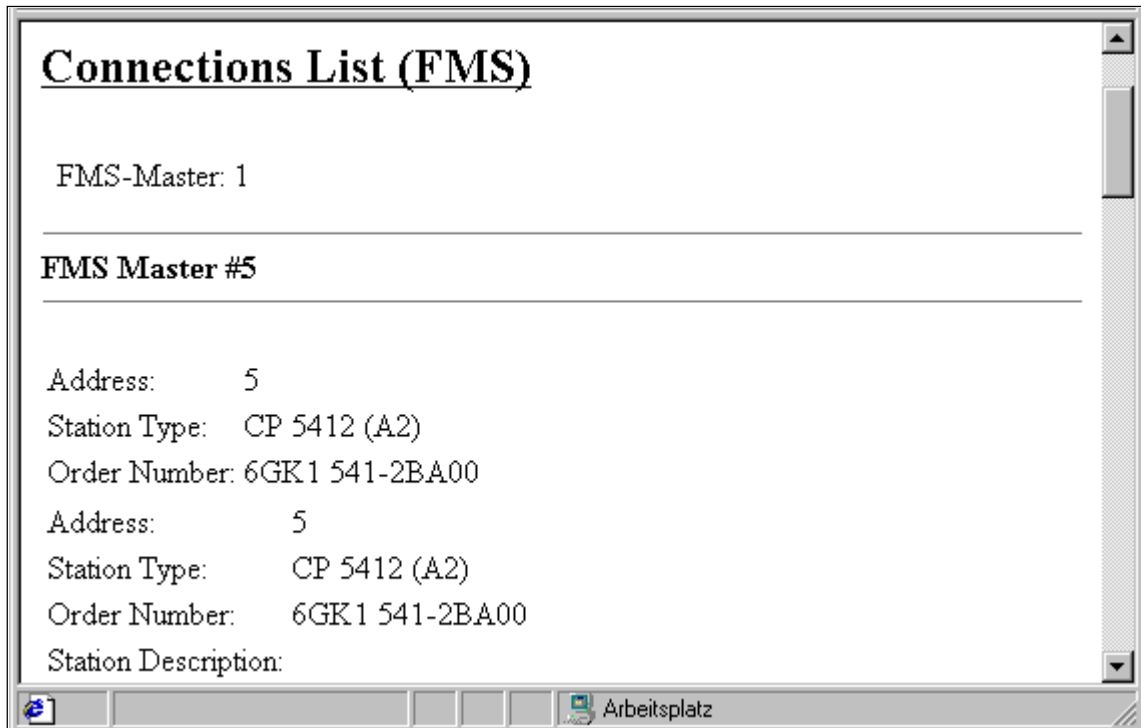



Figure 5-16 The "Documentation Connections List (FMS)" overview

Print the connection overview (FMS)

1. Choose the **File > Print** menu command or .
2. Specify the print properties, and then click "OK".

Result: The "Documentation Connections List (FMS)" overview is printed out.

5.11 Transferring (exporting) the configuration to an NCM file

For the SIMATIC NET PC module CP 5412 (A2) you need a binary database (.ldb) in NCM format.

COM PROFIBUS only exports the data of one master system to an NCM file.

Note

If your bus configuration consists of several master systems, and you change the parameterization of one master system, you also have to export the configuration data of the other master systems. Otherwise, there will be problems in the bus system, which may even fail.

Transfer the configuration to a binary database (NCM file)

1. Select the FMS master in the window for the graphical bus configuration.
2. Choose **File > Export > NCM File**.
Result: The "Export NCM file as" dialog box appears.
3. Choose a name for the NCM database, give it the extension ".LB", and click "OK".
Result: The "Export NCM file" dialog box appears. COM PROFIBUS suggests a response monitoring time on the basis of the bus configuration and the set transmission rate. You can accept this time or set a longer time.
4. Click "OK" to accept the suggested setting.
Result: COM PROFIBUS converts the created configuration of the current master system and creates the following files:
 - NCM file, loadable binary database (.LDB)
 - Error file (.ERR)
5. Choose the **File > Export > NCM File** menu command to load the binary database (NCM file) to the SIMATIC NET PC module.

6 Running PROFIBUS-DP and PROFIBUS-FMS in parallel

The EN 50 170, Volume 2, PROFIBUS standard allows PROFIBUS-DP and PROFIBUS-FMS to be run on a shared physical bus line.

The SIMATIC NET communication processor CP 5412 (A2) permits PROFIBUS-DP and PROFIBUS-FMS to be run simultaneously.

Proceed as follows:

1. Create a new master system by choosing **File > New**.
2. Select the CP 5412 (A2) from the hardware catalog as the DP master, and then move it (by dragging and dropping it) to the window on the right for the graphical bus configuration (see Figure 4-1).
3. Select another CP 5412 (A2) from the hardware catalog as the FMS master, and then move it too (by dragging and dropping it) to the window on the right for the graphical bus configuration.
4. Double-click the icon of the second CP 5412 (A2) (FMS master).
Result: The master parameters dialog box appears.
5. Enter the PROFIBUS address of the first CP 5412 (A2) (DP master).
6. Respond with "Yes" to the query as to whether the CP 5412 (A2) is to be run in parallel mode (DP and FMS).

Result: Both icons for the CP 5412 (A2) have the same PROFIBUS address.

COM PROFIBUS creates a separate master system under the same PROFIBUS address for each log. The nodes you configure depend on which COM PROFIBUS view you are in (master system <i> or FMS). In the master system <i> view you configure the DP slaves, and in the FMS view you configure the FMS stations.

You will find information on configuring the DP slaves in Chapter 4 and on configuring the FMS stations in Chapter 5.

7 Importing configurations

Preliminary remark

Normally you work with an existing program file or create a new program file. Only in exceptional cases, such as when the program file is lost or when data is imported that was created using a different configuration tool (ASCII data), do you require the import function.

Importing data

Depending on the master there are various ways of reading in or importing the data of a master system using COM PROFIBUS:

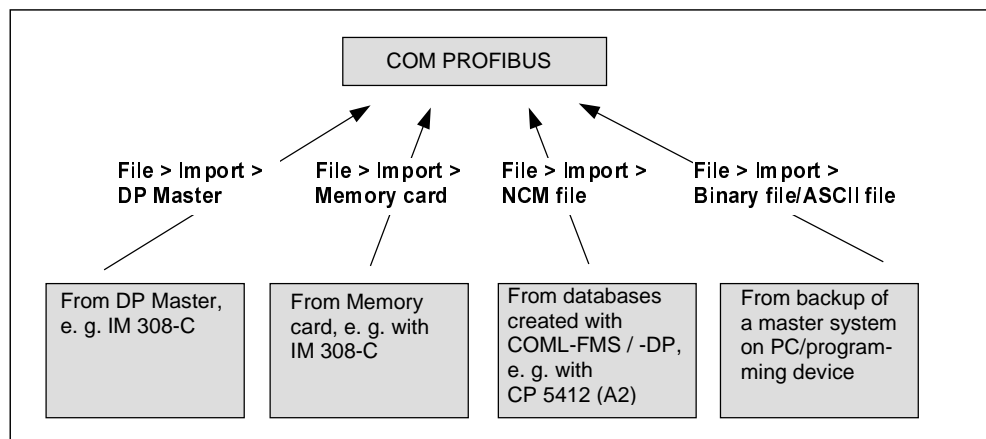

Figure 7-1 Options for importing master systems

Note

COM PROFIBUS receives the data of **one** master system at each import. Only if you read in all the master systems (from DP master, memory card, NCM file and binary file) that together form the complete configuration of a bus system can you reconstruct the entire configuration of the bus system and save it in an overall program file.

Importing data from a DP master

Before you can import the data directly from a DP master:

- The programming device/PC (with a PROFIBUS card) must be connected to the PROFIBUS bus system or directly to the DP master.
- The PC/programming device interface must be set (see Chapter 2).
- A master system must have been transferred to the DP master.
- When the IM 308-C is a DP master, and only then, the memory card must be inserted.
- When the S5-95U is a DP master, and only then, the 32 K-EEPROM must be in the S5-95U.

Choose **File > Import > DP Master** or  to read in the data. During the import process you are asked questions and offered options to select in dialog boxes. The online help system supports you in this.

Result: The data of a master system is in the open program file.

Importing data from a memory card

Before you can import data from a memory card:

- The programming device must have a memory card interface, or
- The programming device must have an E(E)PROM slot with the associated programming adapter, or
- The PC must have an external PROM programmer.
- The memory card must be parameterized (see Chapter 2).
- The memory card must be inserted in the memory card interface of the programming device or PC.

Choose **File > Import > Memory Card** to read in the data. During the import process you are asked questions and offered options to select in dialog boxes. The online help system supports you in this.

Result: The data of a master system is in the open program file.

Importing data from an NCM file

The **File > Import > NCM File** function allows you to read databases into COM PROFIBUS that you have created using the SIMATIC NET PC configuration tools (e.g. COML-DP or COML-FMS).

Importing data from a binary file

You only need this function if your original program file has got lost but was previously saved as a binary file.

To read in data from a binary file:

1. Choose **File > Import > Binary File**:
2. Select a file with the extension ".2BF".

Result: The binary file is converted to a format that COM PROFIBUS can read, and it is then read in. The contents of a binary file correspond to a master system. The data of the binary file is in the open program file.

8 Exporting configurations

Exporting data

The following options are available for exporting data with COM PROFIBUS.

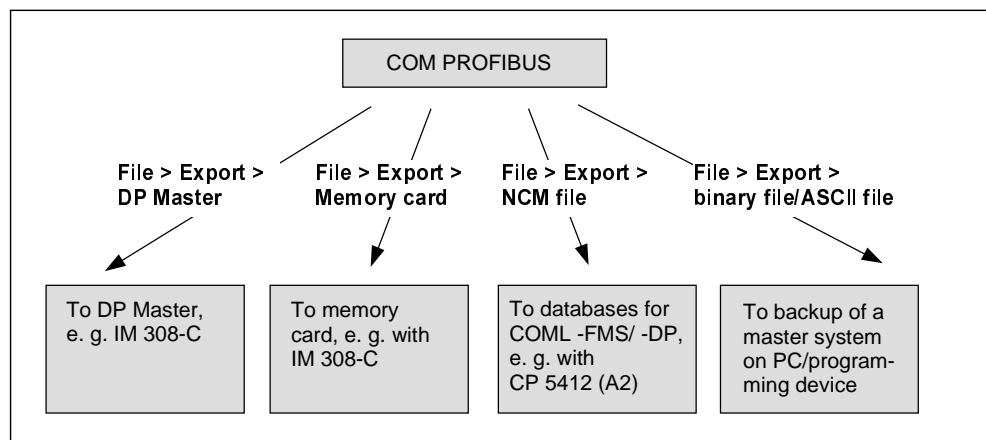

Figure 8-1 Options for exporting master systems

Note

COM PROFIBUS transfers the data of **one** master system at each export.

If your bus configuration consists of several master systems and you change the parameterization of a master system, you also have to reparameterize the other masters. Otherwise, there will be problems in the bus system, which may even fail (e.g. due to a change in the response monitoring time).

Exporting data to a DP master

Before you can export the data directly to a DP master:

- The programming device/PC (with a PROFIBUS card) must be connected to the PROFIBUS bus system or directly to the DP master.
- The PC/programming device interface must be set (see Chapter 2).
- When the IM 308-C is a DP master, and only then, the memory card must be inserted.
- When the S5-95U is a DP master, and only then, the 32 K-EEPROM must be in the S5-95U.

Choose **File > Export > DP Master** or  to transfer the data. During the export process you are asked questions and offered options to select in dialog boxes. The online help system supports you in this.

Result: The data of a master system is transferred to the DP master and may be stored on the inserted storage medium (memory card or 32 K-EEPROM).

Note

Since the default parameter set (e.g. for the IM 308-C: transmission rate = 19.2 kbps and PROFIBUS address = 1) is stored on the DP master, there must be no other node on the PROFIBUS bus with the default PROFIBUS address (e.g. 1) and a different transmission rate must not be set.

Activating the parameter set

If you are running multiple master systems (multiple DP masters) on the PROFIBUS bus, you should activate the new parameter sets synchronously. There are two ways to do this:

- Only in the case of the last master system do you respond with "Yes" to the last query as to whether you want to accept the parameter set when exporting.
- You respond with "No" to the query as to whether you want to accept the parameter set when exporting all the master systems, and you then choose **Service > Activate Parameter Set**.

Exporting data to a memory card

Before you can import data from a memory card:

- The programming device must have a memory card interface, or
- The programming device must have an E(E)PROM slot with the associated programming adapter, or
- The PC must have an external PROM programmer.
- The memory card driver must be parameterized (see Chapter 2).
- The memory card must be inserted in the memory card interface of the programming device or PC.

Choose **File > Export > Memory Card** to read in the data. During the export process you are asked questions and offered options to select in dialog boxes. The online help system supports you in this.

Result: The configuration data is stored on the memory card. You can then insert the memory card in the IM 308-C, for example.

Exporting data to an NCM file

You need binary databases in NCM format for SIMATIC NET PC modules (e.g. for the CP 5412 (A2)).

The **File > Export > NCM File** function allows you to create databases in NCM format with COM PROFIBUS. You can then use the **Service > Setting the PG/PC Interface** function to load a database created in this way to a locally installed module.

If you have installed a corresponding SIMATIC NET PC module, and one of the following products is also installed, COM PROFIBUS offers you the Export and Load NCM File functions in the pop-up menu for the module. This allows you to create a database and load it to the module immediately without having to use the **Setting the PG/PC Interface** function.

Product	Version
PG-5412/Windows 98, NT 4.0	As of V 5.1
DP-5412/Windows 98, NT 4.0	As of V 5.1
FMS-5412/Windows 98, NT 4.0	As of V 5.1
SOFTNET-DP/ Windows 98,NT 4.0	As of V 5.1

Exporting data to a binary file

You only need this function for DP masters that cannot read a memory card or do not support the function for exporting data to a DP master.

To save data in a binary file:

1. Choose **File > Export > Binary File**:
2. Enter a file name with the extension ".2BF".

Result: The data of the open master system is converted by COM PROFIBUS and saved in a binary file.

9 Device master files

A device master file is required for every PROFIBUS device so that it can be integrated in COM PROFIBUS.

What is a device master file?

A device master file (GSD file) contains a device description in a uniform format stipulated by the EN 50 170, Volume 2, PROFIBUS standard.

Device master files are located in COM PROFIBUS's "\GSD" directory.

Listing device master files

The **Documentation > GSD Files** menu command lists all the device master files in COM PROFIBUS together with the device name and version in each case.

Reading in a device master file

If you copy new device master files to the "\GSD" directory while COM PROFIBUS is running, you must then read the directory in again by means of **File > Read in GSD Files**.

Creating a device master file

To enable DP slaves of the ET 200 family to be connected to DP masters of other vendors, you can create device master files with the completed configuration data of a DP slave (except for address assignment). You thus use the user-friendly plain-text parameterization of COM PROFIBUS:

In COM PROFIBUS you create a master system with a default master. You then select the DP slave in the graphical editing window and choose the **File > Create GSD File** menu command. During the process of creating the file you are asked questions and offered options to select in dialog boxes. The online help system supports you in this.

Result: The device master files created in this way are stored by COM PROFIBUS in the ...\\DATA directory.

You then copy the device master file to the device master file directory of the other configuration tool. The DP slave is thus available in the other configuration tool with fixed parameterization; only address assignment is still necessary.

ET 200 distributed I/O devices and Siemens field devices

To enable ET 200 distributed I/O devices and Siemens field devices to be connected, COM PROFIBUS is shipped with the corresponding device master files. The device master files of new Siemens I/O devices whose device master files are not in COM PROFIBUS's GSD directory are available from the interface center. You can download them by modem on:

- Tel. +49 (911) 737972
- Tel. +49 (911) 730983

Alternatively, you can download the device master files for SIEMENS devices on the Internet. You will find all the device master files under "Downloads" on the SIMATIC Customer Support Web page at http://www.ad.siemens.de/csi_e/gsd.

Field devices of other vendors

To enable field devices of other vendors to be connected, device master files that can be integrated in the configuration tools are generally supplied with these field devices. COM PROFIBUS can interpret these device master files provided the files are created in accordance with the EN 50170, Volume 2, PROFIBUS standard.

Copy these device master files to the "\\GSD" directory, and then choose **File > Read in GSD Files**.

10 Assigning shared input masters

Definition

Every DP slave with inputs can be read accessed not only by the parameter assignment master but by other DP masters as well. These DP masters are known as shared input masters. The DP slaves accessed by a shared input master are known as shared input slaves.

Requirement

Before you assign the DP slave a shared input master, you must have configured the DP slave fully in another master system and set all the slave properties.

Assigning a shared input master

1. Select a DP slave from the module catalog, and
2. Drag it to the master system containing the shared input master.
3. Double-click the icon for the DP slave.

Result: The "Slave properties" dialog box appears.

4. Click the "Shared master" button.

Result: The "Selection: Shared master" dialog box appears.

5. Select the shared input master, and then click OK.

Result: The shared input master now has read access to the inputs of the DP slave.

11 Taking into account other masters that are not contained in COM PROFIBUS

Definition

If there are other masters on the bus - **in addition to** the masters entered with COM PROFIBUS - you must take these into account in the target rotation time.

Note

Once you have used COM PROFIBUS to configure all the masters that together form a bus system, COM PROFIBUS calculates the total target rotation time automatically. In this case, you do not have to take into account any other target rotation times.

Taking into account non-COM PROFIBUS masters

In order to take into account the target rotation time of a master not contained in COM PROFIBUS, proceed as follows:

1. Fully configure both master systems. This results in a target rotation time (TTR) for each master system:
 - TTR1: Calculated by COM PROFIBUS
 - TTR2: Calculated by another software tool

The sum of the two target rotation times (TTR) is the final target rotation time.

2. Choose **Configure > Set Bus Parameters** in COM PROFIBUS, and then click the "Set parameters" button.

Result: The "Bus Parameters" dialog box appears.

3. Note the target rotation time (TTR1) calculated by COM PROFIBUS.
4. Enter for the "Delta Ttr" parameter the time in bit time units that you have calculated as the target rotation time (TTR2) for the non-COM PROFIBUS master.

Result: When you click the "Calculate" button, COM PROFIBUS calculates the new target rotation time (Ttr) in bit time units.

5. In the non-COM PROFIBUS master system, add the target rotation time (TTR1) noted under step 3 to the target rotation time (TTR2) of the non-COM PROFIBUS master system.
6. You may need to modify additional bus parameters.

Subsequent changes

If you make changes after you have changed the target rotation time appropriately, proceed as follows:

1. Obtain the target rotation times in all the master systems again.
2. To calculate the new target rotation time, carry out steps 1 to 5 above.

12 Tips and tricks

How to find the PROFIBUS device in the hardware catalog

Select the area in the hardware catalog, and then press the key combination <SHIFT> + <+> (on the numeric keypad).

Result: The entire catalog is displayed. You can find your PROFIBUS device quickly by using the scroll bar.

Press the key combination <SHIFT> + <-> (on the numeric keypad) to close the catalog again.

What to do if the PROFIBUS device does not appear in the hardware catalog

Proceed as follows:

1. Choose the **File > Read in GSD Files** menu command.
2. Choose the **Documentation > GSD Files** menu command.
Result: A list of all the device master files known to COM PROFIBUS appears together with the path in the hardware catalog.
3. Look for your PROFIBUS device in the list.
4. If a device master file is not displayed for your PROFIBUS device, change to Windows Explorer.
5. Check whether the device master file is in the ...\\gsd, ...\\fsmgsd directory. You will find the name of the associated device master file in the documentation for the device.

If the device master file is not there, you must obtain it from the vendor (see Chapter 9).

How to display the data cycle times

If you choose **Service > Data Cycle Times**, COM PROFIBUS displays the data cycle times such as the response monitoring time for the configuration entered.

How to take other masters into account

If there are other masters on the bus - **in addition to** the masters entered with COM PROFIBUS - you must take these into account in the target rotation time.

Proceed as described in detail in Chapter 11.

How to document a configuration

COM PROFIBUS provides you with the following lists for documenting the completed configuration:

Table 12-1 Documenting the completed configuration

Documentation > ... menu command	Shows ...
Bus Parameters	... the transmission rate, the bus profile and the bus times, among other things.
Station List	... a list of all the stations on the bus, arranged by their PROFIBUS addresses, with their names and the master or host to which they are assigned.
Host/Master Systems	... the configuration of the host, the masters assigned to it, and which PROFIBUS addresses of the DP slaves/FMS stations are assigned to a master.
Group	... which DP slave is assigned to which group with what properties (FREEZE, SYNC).
Station-oriented Address Assignment	... which STEP 5 addresses are assigned to a DP slave.
Area-oriented Address Assignment	... how the STEP 5 address area is split up among the different DP slaves.
Connection Overview (FMS)	... which FMS connections to an FMS station have been configured (only in the case of FMS configuration)
GSD Files	... which device master files are in a directory known to COM PROFIBUS and which station types which device master file is assigned to.

To obtain a printout, click the desired documentation list and then choose

File > Print or .

How to activate a parameter set on a DP master

When you export the data of a master system directly to the DP master by means of the **File > Export > DP Master** function, the new parameter set is not immediately valid.

COM PROFIBUS asks whether the transferred parameter set is to be activated immediately in the DP master:

- If there is only one DP master on the PROFIBUS bus, respond with "Yes" to activate the parameter set immediately.
- If there are at least two DP masters on the PROFIBUS bus, respond with "No". Transfer all the configuration data to the DP masters, and then activate the configuration data by choosing **Service > Activate Parameter Set**.

It is thus possible to activate parameter sets synchronously.

How to switch COM PROFIBUS offline/online

If programming devices/PCs are being run online on the PROFIBUS bus - for the display of diagnostic messages or the status, for example - and you want to disconnect the programming devices/PCs from the PROFIBUS bus, choose **Service > Switch PG/PC Offline**.

What to do if you do not have the device master files you need

In the case of PROFIBUS devices of other vendors, please contact the vendor.

In the case of Siemens PROFIBUS devices, the device master files are available at the interface center. You can download them by modem on:

- Tel. +49 (911) 737972
- Tel. +49 (911) 730983

Alternatively, you can download the device master files on the Internet. You will find all the device master files under "Downloads" on the SIMATIC Customer Support Web page at http://www.ad.siemens.de/csi_e/gsd.

Glossary

Address identifier

The address identifier (also known simply as an identifier or ID) is a decimal number in which the properties of the input and output areas of the slaves are stored at DP configuration.

The binary encoding (identifier format) of the address identifier for DP slaves is specified in the EN 50170, Volume 2, PROFIBUS standard.

Binary file

File (with the extension .5BF) that contains all the parameters created with COM PROFIBUS for a master system.

The format of the binary file corresponds to that of the memory card. Masters that cannot read a memory card or do not support the function for exporting a configuration to a DP master can be supplied by means of this binary file.

Directory: ...\\DATA

Bus

The bus is the common transfer medium that connects all the nodes in the network. A PROFIBUS bus is a two-wire cable or fiber-optic cable.

Client/server principle

In client/server data interchange, the client always issues the communication requests and the server executes them.

Compact DP slave

The structure of a compact DP slave is unchangeable in the input and output areas (e.g. ET 200B).

Configuration

Selection and compilation of the components of a DP slave and assignment of addresses to the various input and output areas of the components.

Device master file

The device master file contains the device master data (electronic data sheet) of the PROFIBUS device and must be created by the manufacturer of the device.

The structure of the device master file is specified in the EN 50170, Volume 2, PROFIBUS standard. The file is required in order to configure the PROFIBUS device.

- Directory: ...\`GSD` for DP slaves and DP masters
- Directory: ...\`FMSGSD` for FMS stations and FMS masters

Diagnostic overview

The diagnostic overview shows all the DP master's DP slaves with which data interchange is taking place and from which diagnostic data is available (slave diagnosis).

DP master

Master that complies with the EN 50170, Volume 2, PROFIBUS standard with the DP protocol (DP is the German abbreviation for distributed I/O).

DP slave

Slave that complies with the EN 50170, Volume 2, PROFIBUS standard and is addressed by means of the DP bus protocol (DP is the German abbreviation for distributed I/O).

FMS connection

An FMS connection contains the descriptions of the communication relationship between one PROFIBUS node and another PROFIBUS node. A communication relationship is uniquely described by a name, the type of the FMS connection (for management or users), the PROFIBUS addresses, the assigned VFDs and a communication reference (CR).

FMS master

Master that complies with the EN 50170, Volume 2, PROFIBUS standard with the FMS protocol (FMS = Fieldbus Message Specification).

FMS station

Master or slave that complies with the EN 50170, Volume 2, PROFIBUS standard and is addressed by means of the FMS bus protocol (FMS = Fieldbus Message Specification).

FREEZE

Control command of the DP master to a group of DP slaves.

After receiving the FREEZE control command, the DP slave freezes the current status of the **inputs** and transfers them cyclically to the DP master. The DP slave freezes the status of the inputs again after each FREEZE control command. The input data is not transferred cyclically from the DP slave to the DP master again until the DP master sends the UNFREEZE control command.

Group

Group of DP slaves of a master system to which the FREEZE and/or SYNC control command can be applied.

Group association

Membership of a DP slave in a group. Groups allow you to apply the control commands of the DP master to a specific selection of slaves of a master system.

Hardware catalog

The hardware catalog is a selection window in the COM PROFIBUS user interface that contains all the PROFIBUS devices that can be configured with COM PROFIBUS. Only those devices for which there is an error-free device master file in COM PROFIBUS's GSD directory (... \gsd or ... \fmsgsd) are displayed.

Host

System that contains at least one master. In the case of the IM 308-C master interface module, a programmable controller with the S5-CPU represents the host. In some cases (e.g. CP 5412 (A2), S5-95U) the master itself is the host.

Note: The masters in a PROFIBUS-DP bus system can be distributed across a maximum of 32 hosts.

LSAP

An LSAP (**Link Service Access Point**) is a layer-2 access point (address).

Master system

A master system comprises a master and the slaves or FMS stations assigned to it. Multiple master systems can be run in a PROFIBUS bus system.

Memory card

Storage module on which the configuration of a master system is stored.

Modular DP slave

In the case of modular DP slaves, the structure of the input and output areas used is variable and is not defined until the DP slave is configured (e.g. ET 200M).

Module catalog

The module catalog is a selection window in the COM PROFIBUS user interface that contains all the PROFIBUS devices that can be configured with COM PROFIBUS. Only those devices for which there is an error-free device master file in COM PROFIBUS's ... \gsd directory are displayed.

NCM file

File (with the extension .LDB) that contains all the parameters created with COM PROFIBUS for a master system. This file is required as a binary database for the SIMATIC NET PC modules.

Directory: ... \NCM

Offline

Status of a programming device/PC that is not directly connected to a PROFIBUS node for the purpose of data transmission on the PROFIBUS bus.

Online

Status of a programming device/PC that is directly connected to a PROFIBUS node for the purpose of data transmission on the PROFIBUS bus.

Online help system

You can access all the information you need in the COM PROFIBUS online help system. You call the help system by choosing the **Help** menu in COM PROFIBUS.

Parameter assignment

The selection of settings that specify the responses of modules.

Parameter assignment master

Each DP slave has a parameter assignment master (class 1). At start-up the parameter assignment master transfers the parameters to the DP slave. The parameter assignment master has read and write access to the DP slave.

Power-up delay

The power-up of the CPU is suspended until the power-up delay time has elapsed or all the configured DP slaves can be addressed. If not all the configured DP slaves can be addressed before this time elapses, the CPU starts up anyway.

If "No error reporting mode" is selected, the CPU starts up without a power-up delay time.

The power-up delay time is in the range from 20 s to 1200 s.

PROFIBUS

PROcess Field BUS, a European process and field bus standard defined in EN 50170, Volume 2, PROFIBUS. It specifies the functional, electrical and mechanical properties of a bit-serial field bus.

PROFIBUS is available with the protocols DP (which is the German abbreviation for distributed I/O), FMS (Fieldbus Message Specification) and PA (Process Automation).

PROFIBUS address

Each bus node must have a PROFIBUS address so that it can be identified uniquely. The default bus address "0" is reserved for programming devices/PCs in the PROFIBUS bus system. Addresses from 1 to 125 are available for the other bus nodes.

PROFIBUS card

Interface card for connecting programming devices/PCs to the PROFIBUS bus.

PROFIBUS-DP

Field bus that connects all DP masters and DP slaves. The PROFIBUS-DP field bus is based on the EN 50170, Volume 2, PROFIBUS standard with the DP protocol (DP is the German abbreviation for distributed I/O).

PROFIBUS-FMS

Field bus that connects all FMS masters and FMS stations. The PROFIBUS-FMS field bus is based on the EN 50170, Volume 2, PROFIBUS standard with the FMS protocol (FMS = Fieldbus Message Specification).

Program file

File (with the extension .PB5) in which you save the configurations of all the master systems in a PROFIBUS bus system in COM PROFIBUS. You can transfer the configuration of **a single** master system from the program file to the DP master, a memory card, a binary file or a binary database (only in the case of SIMATIC NET PC modules).

Directory: ...\\DATA

Response monitoring

Monitoring time for a DP slave. If a DP slave is not addressed within the response monitoring time, it switches to the safe state (i.e. it sets its outputs to "0").

Response monitoring can be switched on and off individually for each DP slave during configuration.

Shared input master

Every DP slave assigned to a parameter assignment master can be **read** accessed by other DP masters. These DP masters are known as shared input masters.

Slave diagnosis

Diagnostic data of a DP slave, structured as defined in the EN 50170, Volume 2, PROFIBUS standard.

Slot

The slot (consecutive number) identifies an input or output area of the DP slave.

Station type

You select the station type of the slave or master to be configured after the order number and name.

SYNC

Control command of the DP master to a group of DP slaves.

The DP master uses the SYNC control command to cause the DP slave to freeze the statuses of the **outputs** at the current value. For the following frames, the DP slave saves the output data, but the statuses of the outputs remain unchanged. After each new SYNC control command, the DP slave sets the outputs that it has saved as output data.

The outputs are not cyclically updated again until the DP master sends the UNSYNC control command.

Target rotation time

This is the maximum time available for token rotation. The difference between this and the actual token rotation time determines how much time the master still has to send its data frames to the slaves.

Transmission rate

Speed at which data is transmitted; specified in number of bits transmitted per second (bps).

Transmission rates of 9.6 kbps to 12 Mbps are possible with PROFIBUS-DP and rates of 9.6 kbps to 1.5 Mbps with PROFIBUS-FMS.

VFD

A VFD (virtual field device) is a representation of a real field device. Its purpose is to provide a uniform view of any device.

Index

Assigning a PROFIBUS address.....	51	ET 200S, parameterizing	41
Assigning groups.....	46	Exporting configurations	87
Assigning shared input masters	93	Exporting data.....	87
Binary file.....	83, 87	Exporting to an NCM file.....	79
Bus parameters	95	Exporting to the DP master.....	49
Client and server services for ET 200U		FMS configuration example	57
DP/FMS	76	FMS masters	9
Client and server services for S7-300 CP 343-		FMS stations.....	9
5 FMS.....	70	Hardware catalog.....	18
COM PROFIBUS.....	7	IM 308-C as DP master and DP slave	45
Commissioning.....	48	IM 308-C as DP slave	51
Commissioning the bus configuration.....	53	IM 308-C as DP slave, DP master not	
Commissioning the IM 308-C	53	configured with COM PROFIBUS	45
Communication parameters for ET 200U		IM 308-C, configuring as DP slave.....	44
DP/FMS	73	Importing configurations.....	83
Communication parameters for S7-300		Importing data	83
CP 343-5 FMS.....	65	Installing COM PROFIBUS	13
Configurable DP masters	8	Installing the manuals	13
Configurable DP slaves.....	8	Listing device master files.....	91
Configurable FMS masters.....	9	Master diagnosis.....	54
Configurable FMS stations	9	Masters on the bus not configured with	
Configuration example FMS.....	57	COM PROFIBUS	95
Configuring the ET 200B	28	Memory card	83, 87
Configuring the ET 200M.....	32	Memory card parameterization	13
Configuring the ET 200S	37	NCM file	83, 87
Configuring the IM 308-C as DP slave	44	Online help system	10
Connection overview (FMS)	78	Online mode	48
Connection parameters for ET 200U DP/FMS ..	73	Online operation.....	12
Connection parameters for S7-300 CP 343-5		Parameterizing ET 200B.....	27
FMS.....	65	Parameterizing S7-300 CP 343-5 FMS.....	65
Connection types.....	68	Parameterizing the ET 200B.....	30
Creating a device master file.....	91	Parameterizing the ET 200M	31, 35
Device master file	9, 91	Parameterizing the ET 200S.....	36, 41
Diagnosing the signal states.....	52	Parameterizing the ET 200U DP/FMS	72
Diagnostic overview.....	54	Parameterizing the IM 308-C as DP slave	42
Documentation functions.....	47, 78	Printing.....	47, 78
Documenting and printing.....	47, 78	Programming device/PC interface, setting.....	14
DP masters.....	8	Read in the device master files.....	58
DP sample configuration	19	Reading in a device master file	20, 91
DP slaves	8	Readme file.....	11
Entering bus parameters	60	Requirements	11, 12
Entering host parameters	26	Response monitoring for ET 200B.....	28
Entering master parameters	24, 62	Response monitoring for ET 200M	32
Error diagnosis	54	Response monitoring for ET 200S.....	37
ET 200B, configuring.....	28	Response monitoring for IM 308-C as DP	
ET 200B, parameterizing.....	30	slave	43
ET 200M, configuring	32	Running CP 5412 (A2) as DP and FMS	
ET 200M, parameterizing	35	master.....	81
ET 200S, configuring.....	37		

Running PROFIBUS-DP and PROFIBUS- FMS in parallel	81	Starting COM PROFIBUS.....	14
Saving	47, 78	Station parameters for ET 200U DP/FMS.....	72
Scope of the delivery package	12	Station parameters for S7-300 CP 343-5 FMS .	65
Setting the programming device/PC interface...	14	Terms of the license agreement	11
Several masters on the bus	21, 22, 59	Testing the signal states	52
Slave diagnosis.....	56	Toolbar	17
Slave parameter for the IM 308-C as DP slave.	42	Transferring to an NCM file.....	79
Slave parameters for ET 200B.....	27	Transferring to the DP master	49
Slave parameters for ET 200M	31	Uninstalling.....	14
Slave parameters for ET 200S.....	36	Uninstalling COM PROFIBUS	14
Starting.....	14	User interface	15