

SIEMENS

SIMATIC

S7-300 CPU 31xC and CPU 31x: Specifications

Manual

Preface

Guide to the S7-300
documentation

1

Operating and display
elements

2

Communication

3

Memory concept

4

Cycle and reaction times

5

General technical data

6

Technical data of CPU 31xC

7

Technical data of CPU 31x

8

Appendix

A

This manual is included in the documentation package
with Order No.:

6ES7398-8FA10-8BA0

06/2008

A5E00105475-08

Legal information

Warning notice system

This manual contains notices you have to observe in order to ensure your personal safety, as well as to prevent damage to property. The notices referring to your personal safety are highlighted in the manual by a safety alert symbol, notices referring only to property damage have no safety alert symbol. These notices shown below are graded according to the degree of danger.

DANGER

indicates that death or severe personal injury **will** result if proper precautions are not taken.

WARNING

indicates that death or severe personal injury **may** result if proper precautions are not taken.

CAUTION

with a safety alert symbol, indicates that minor personal injury can result if proper precautions are not taken.

CAUTION

without a safety alert symbol, indicates that property damage can result if proper precautions are not taken.

NOTICE

indicates that an unintended result or situation can occur if the corresponding information is not taken into account.

If more than one degree of danger is present, the warning notice representing the highest degree of danger will be used. A notice warning of injury to persons with a safety alert symbol may also include a warning relating to property damage.

Qualified Personnel

The device/system may only be set up and used in conjunction with this documentation. Commissioning and operation of a device/system may only be performed by **qualified personnel**. Within the context of the safety notes in this documentation qualified persons are defined as persons who are authorized to commission, ground and label devices, systems and circuits in accordance with established safety practices and standards.

Prescribed Usage

Note the following:

WARNING

This device may only be used for the applications described in the catalog or the technical description and only in connection with devices or components from other manufacturers which have been approved or recommended by Siemens. Correct, reliable operation of the product requires proper transport, storage, positioning and assembly as well as careful operation and maintenance.

Trademarks

All names identified by ® are registered trademarks of the Siemens AG. The remaining trademarks in this publication may be trademarks whose use by third parties for their own purposes could violate the rights of the owner.

Disclaimer of Liability

We have reviewed the contents of this publication to ensure consistency with the hardware and software described. Since variance cannot be precluded entirely, we cannot guarantee full consistency. However, the information in this publication is reviewed regularly and any necessary corrections are included in subsequent editions.

Preface

Purpose of the Manual

This manual contains essential information:

- about installation
- about communication
- about the memory concept
- about the cycle and response times,
- about the CPU technical data,
- about changing to one of the CPUs discussed here.

Required basic knowledge

- To understand this manual, you require a general knowledge of automation engineering.
- You require a knowledge of STEP 7 basic software.

Area of application

Table 1 Scope of this manual

CPU	Convention: CPU designations:	Order number	As of Version firmware
CPU 312C	CPU 31xC	6ES7312-5BE03-0AB0	V2.6
CPU 313C		6ES7313-5BF03-0AB0	V2.6
CPU 313C-2 PtP		6ES7313-6BF03-0AB0	V2.6
CPU 313C-2 DP		6ES7313-6CF03-0AB0	V2.6
CPU 314C-2 PtP		6ES7314-6BG03-0AB0	V2.6
CPU 314C-2 DP		6ES7314-6CG03-0AB0	V2.6
CPU 312	CPU 31x	6ES7312-1AE13-0AB0	V2.6
CPU 314		6ES7314-1AG13-0AB0	V2.6
CPU 315-2 DP		6ES7315-2AG10-0AB0	V2.6
CPU 315-2 PN/DP		6ES7315-2EH13-0AB0	V2.6
CPU 317-2 DP		6ES7317-2AJ10-0AB0	V2.6
CPU 317-2 PN/DP		6ES7317-2EK13-0AB0	V2.6
CPU 319-3 PN/DP		6ES7318-3EL00-0AB0	V2.7

Note

The special features of the F-CPU's of the S7 spectrum can be found as product information on the Internet (<http://support.automation.siemens.com/WW/view/en/11669702/133300>).

Note

For new modules, or modules of a more recent version, we reserve the right to include a Product Information containing latest information.

Changes in comparison to the previous version

Changes compared to the previous version of this Manual CPU31xC and CPU31x: Technical Data, Release 12/2006 (A5E00105491-07):

New properties of the CPU 319-3 PN/DP V2.7

- PROFINET IO with IRT (Isochronous Real Time) with the option "High flexibility"
- Prioritized startup for IO devices
- Replacing of PROFINET IO devices without removing the storage medium
- Changing IO devices during operation (changing partner ports)
- Increase in the OUC connection resources from previously 8 to 32
- Increase in the maximum number of simultaneously active Alarm-S blocks to 300
- CBA extensions (supporting of further data structures)
- Data set routing
- Extension of the Web server functionality:
 - Module state
 - Topology

Firmware update via networks is possible for all CPUs.

Standards and certifications

In Chapter *General technical data*, you will find information about standards, certificates and approvals

Recycling and Disposal

The devices described in this manual can be recycled, due to their ecologically compatible components. For environment-friendly recycling and disposal of your old equipment, contact a certified disposal facility for electronic scrap.

Table of contents

	Preface	3
1	Guide to the S7-300 documentation	9
1.1	Documentation classification	9
1.2	Guide to the S7-300 documentation	12
2	Operating and display elements	17
2.1	Operating and display elements: CPU 31xC	17
2.1.1	Operating and display elements: CPU 31xC	17
2.1.2	Status and error indicators: CPU 31xC.....	20
2.2	Operating and display elements: CPU 31x.....	21
2.2.1	Operating and display elements: CPU 312, 314, 315-2 DP:	21
2.2.2	Operating and display elements: CPU 317-2 DP	23
2.2.3	Operating and display elements: CPU 31x-2 PN/DP	25
2.2.4	Operating and display elements: CPU 319-3 PN/DP	27
2.2.5	Status and error displays of CPU 31x.....	29
3	Communication.....	31
3.1	Interfaces	31
3.1.1	Multi-Point Interface (MPI)	31
3.1.2	PROFIBUS DP	34
3.1.3	PROFINET	37
3.1.3.1	Configuring the port properties	40
3.1.4	Point to Point (PtP)	41
3.2	Communication services.....	42
3.2.1	Overview of communication services	42
3.2.2	PG communication.....	44
3.2.3	OP communication.....	44
3.2.4	Data exchanged by means of S7 basic communication.....	44
3.2.5	S7 communication	45
3.2.6	Global data communication (MPI only).....	46
3.2.7	Routing.....	47
3.2.8	Data set routing.....	51
3.2.9	Point-to-point connection	52
3.2.10	Data consistency.....	52
3.2.11	Communication by means of PROFINET	53
3.2.11.1	PROFINET IO System	56
3.2.11.2	Blocks for PROFINET IO	58
3.2.11.3	Open communication via Industrial Ethernet.....	60
3.2.11.4	SNMP Communication Service.....	63
3.3	Web server.....	64
3.3.1	Language settings.....	66
3.3.2	Settings in HW Config, "Web" tab.....	68
3.3.3	Updating.....	70

3.3.4	Web pages	71
3.3.4.1	Start page with general CPU information.....	71
3.3.4.2	Identification	73
3.3.4.3	Diagnostics buffer	74
3.3.4.4	Module state.....	76
3.3.4.5	Messages	82
3.3.4.6	PROFINET	84
3.3.4.7	Topology.....	86
3.3.4.8	Variable status	90
3.3.4.9	Variable tables	91
3.4	S7 connections.....	94
3.4.1	S7 connection as communication path	94
3.4.2	Assignment of S7 connections.....	95
3.4.3	Distribution and availability of S7 connection resources.....	97
3.4.4	Connection resources for routing.....	99
3.5	DPV1	100
4	Memory concept.....	103
4.1	Memory areas and retentivity.....	103
4.1.1	CPU memory areas.....	103
4.1.2	Retentivity of load memory, system memory and RAM.....	104
4.1.3	Retentivity of memory objects.....	106
4.1.4	Address areas of system memory	108
4.1.5	Properties of the SIMATIC Micro Memory Card	112
4.2	Memory functions.....	114
4.2.1	General: Memory functions.....	114
4.2.2	Load user program from SIMATIC Micro Memory Card to the CPU	114
4.2.3	Handling with modules.....	115
4.2.3.1	Download of new blocks or delta downloads.....	115
4.2.3.2	Uploading blocks.....	115
4.2.3.3	Deleting blocks.....	116
4.2.3.4	Compressing blocks.....	116
4.2.3.5	Promming (RAM to ROM).....	116
4.2.4	CPU memory reset and restart	117
4.2.5	Recipes	118
4.2.6	Measured value log files	120
4.2.7	Backup of project data to SIMATIC Micro Memory Card.....	122
5	Cycle and reaction times.....	123
5.1	Overview	123
5.2	Cycle time.....	124
5.2.1	Overview	124
5.2.2	Calculating the cycle time	127
5.2.3	Different cycle times.....	130
5.2.4	Communications load.....	131
5.2.5	Cycle time extension as a result of testing and commissioning functions	133
5.2.6	Cycle extension through Component Based Automation (CBA)	134
5.3	Response time	137
5.3.1	Overview	137
5.3.2	Shortest response time	139
5.3.3	Longest response time.....	140
5.3.4	Reducing the response time with direct I/O access.....	141

5.4	Calculating method for calculating the cycle/response time	142
5.5	Interrupt response time	144
5.5.1	Overview	144
5.5.2	Reproducibility of Time-Delay and Watchdog Interrupts	146
5.6	Sample calculations	147
5.6.1	Example of cycle time calculation	147
5.6.2	Sample of response time calculation	148
5.6.3	Example of interrupt response time calculation	150
6	General technical data	151
6.1	Standards and approvals	151
6.2	Electromagnetic compatibility	155
6.3	Transportation and storage conditions for modules	157
6.4	Mechanical and climatic environmental conditions for S7-300 operation	158
6.5	Specification of dielectric tests, protection class, degree of protection, and rated voltage of S7-300	160
6.6	Rated voltages of S7-300	160
7	Technical data of CPU 31xC	161
7.1	General technical data	161
7.1.1	Dimensions of CPU 31xC	161
7.1.2	Technical data of the Micro Memory Card	162
7.2	CPU 312C	163
7.3	CPU 313C	170
7.4	CPU 313C-2 PtP and CPU 313C-2 DP	177
7.5	CPU 314C-2 PtP and CPU 314C-2 DP	185
7.6	Technical data of the integrated I/O	193
7.6.1	Arrangement and usage of integrated I/Os	193
7.6.2	Analog I/O	198
7.6.3	Configuration	204
7.6.4	Interrupts	209
7.6.5	Diagnostics	210
7.6.6	Digital inputs	210
7.6.7	Digital outputs	213
7.6.8	Analog inputs	215
7.6.9	Analog outputs	218
8	Technical data of CPU 31x	223
8.1	General technical data	223
8.1.1	Dimensions of CPU 31x	223
8.1.2	Technical data of the SIMATIC Micro Memory Card	224
8.2	CPU 312	225
8.3	CPU 314	231
8.4	CPU 315-2 DP	237
8.5	CPU 315-2 PN/DP	244
8.6	CPU 317-2 DP	254
8.7	CPU 317-2 PN/DP	263
8.8	CPU 319-3 PN/DP	273

A	Appendix.....	287
	A.1 Information about upgrading to a CPU 31xC or CPU 31x	287
	A.1.1 Scope	287
	A.1.2 Changed behavior of certain SFCs	289
	A.1.3 Interrupt events from distributed I/Os while the CPU status is in STOP	290
	A.1.4 Runtimes that change while the program is running	291
	A.1.5 Converting the diagnostic addresses of DP slaves	291
	A.1.6 Reusing existing hardware configurations	292
	A.1.7 Replacing a CPU 31xC/31x	292
	A.1.8 Using consistent data areas in the process image of a DP slave system	292
	A.1.9 Load memory concept for the CPU 31xC/31x	293
	A.1.10 PG/OP functions	293
	A.1.11 Routing for the CPU 31xC/31x as an intelligent slave	293
	A.1.12 Changed retentive behavior of CPUs with firmware V2.0.12 or higher	294
	A.1.13 FMs/CPs with separate MPI address in the central rack of a CPU 315-2 PN/DP, a CPU 317 or a CPU 319-3 PN/DP	294
	A.1.14 Using loadable blocks for S7 communication for the integrated PROFINET interface	295
	Glossary	297
	Index.....	317

Guide to the S7-300 documentation

1.1 Documentation classification

Documentation classification

The documentation listed below is part of the S7-300 documentation package.

This is also available on the Internet at:

<http://support.automation.siemens.com/WW/view/en/> and the corresponding entry ID

Name of the manual	Description
Manual CPU 31xC and CPU 31x: Technical Data Article ID: 12996906	<ul style="list-style-type: none"> • Operator control and display elements • Communication • Memory concept • Cycle and response times • Technical data
Operating Instructions CPU 31xC and CPU 31x: Installation Entry ID: 13008499	<ul style="list-style-type: none"> • Configuring • Installing • Wiring • Addressing • Start-up • Maintenance and the test functions • Diagnostics and troubleshooting
Manual CPU 31xC: Technological functions incl. CD Entry ID: 12429336	Description of the specific technological functions: <ul style="list-style-type: none"> • Positioning • Counting • Point-to-point connection • Rules The CD contains examples of the technological functions.
Manual S7-300 Automation System: Module data Entry ID: 8859629	Functional descriptions and technical specifications of the following modules: <ul style="list-style-type: none"> • Signal modules • Power supplies • Interface modules

Name of the manual	Description
<p>Instruction List CPU 31xC, CPU 31x, IM151-7 CPU, IM154-8 CPU, BM 147-1 CPU, BM 147-2 CPU Entry ID: 13206730</p>	<p>The instruction list contains:</p> <ul style="list-style-type: none"> • List of the instruction set of the CPUs and their execution times. • List of the executable blocks (OBs/SFCs/SFBs) and their execution times.
<p>Getting Started</p> <ul style="list-style-type: none"> • S7-300 Getting Started Collection Entry ID: 15390497 • PROFINET Getting Started Collection Entry ID: 19290251 	<p>The collections use concrete examples to provide step-by-step instructions on how to commission a fully functional application.</p> <p>S7-300 Getting Started Collection:</p> <ul style="list-style-type: none"> • CPU 31x: Start-up • CPU 31xC: Start-up • CPU 314C: Positioning with analog output • CPU 314C: Positioning with digital output • CPU 31xC: Counting • CPU 31xC: Point-to-point connection • CPU 31xC: Rules <p>PROFINET Getting Started Collection:</p> <ul style="list-style-type: none"> • CPU 315-2 PN/DP, CPU 317-2 PN/DP and CPU 319-3 PN/DP: Configuring the PROFINET interface • CPU 317-2 PN/DP: Configuring an ET 200S as PROFINET IO device

Further Information

You also require information from the following descriptions:

Name of the manual	Description
STEP 7	
System software for S7-300/400 system and standard functions Volume 1/2 Entry ID: 1214574	Overview of the OBs, SFCs, SFBs, IEC functions, diagnostics data, system status list (SSL) and events in the operating systems of the CPUs of the S7-300 and S7-400. This manual is part of the STEP 7 reference information. You can also find the description in the online help for STEP 7.
Programming with STEP 7 Entry ID: 18652056	This manual provides a complete overview of programming with the STEP 7 Standard Package. This manual is part of the STEP 7 Standard Package basic information. A description is also available in the online help for STEP 7.
PROFINET	
PROFINET System Description Entry ID: 19292127	<ul style="list-style-type: none"> • Basic description of PROFINET: • Network components • Data exchange and communication • PROFINET IO • Component Based Automation • Application example of PROFINET IO and Component Based Automation
From PROFIBUS DP to PROFINET IO Entry ID: 19289930	Guideline for the migration from PROFIBUS DP to PROFINET I/O.
SIMATIC NET: Twisted Pair and Fiber-Optic Networks Entry ID: 8763736	Description of Industrial Ethernet networks, network configuration, components, installation guidelines for networked automation systems in buildings, etc.
Component Based Automation	
Configure SIMATIC iMap plants Entry ID: 22762190	Description of the SIMATIC iMap configuration software
SIMATIC iMap STEP 7 AddOn, create PROFINET components Entry ID: 22762278	Descriptions and instructions for creating PROFINET components with STEP 7 and for using SIMATIC devices in Component Based Automation
Isochronous mode Entry ID: 15218045	Description of the system property "Isochronous mode"
SIMATIC communication Entry ID: 1254686	Basics, services, networks, communication functions, connecting PGs/OPs, engineering and configuring in STEP 7.

Service & support on the Internet

Information on the following topics can be found on the Internet (<http://www.siemens.com/automation/service>):

- Contacts for SIMATIC (<http://www.siemens.com/automation/partner>)
- Contacts for SIMATIC NET (<http://www.siemens.com/simatic-net>)
- Training (<http://www.sitrain.com>)

1.2 Guide to the S7-300 documentation

Overview

The following tables contain a guide through the S7-300 documentation.

Ambient influence on the automation system

Information about ...	is available in the manual ...	In Section ...
What provisions do I have to make for automation system installation space?	CPU 31xC and CPU 31x: Installation	Configuring – Component dimensions Mounting – Installing the mounting rail
How do environmental conditions influence the automation system?	CPU 31xC and CPU 31x: Installation	Appendix

Galvanic isolation

Information about ...	is available in the manual ...	In Section ...
Which modules can I use if electrical isolation is required between sensors/actuators?	CPU 31xC and CPU 31x: Installation Module data	Configuring – Electrical assembly, protective measures and grounding
Under what conditions do I have to isolate the modules electrically? How do I wire that?	CPU 31xC and CPU 31x: Installation	Configuring – Electrical assembly, protective measures and grounding Wiring
Under which conditions do I have to isolate stations electrically? How do I wire that?	CPU 31xC and CPU 31x: Installation	Configuring – Configuring subnets

Communication between sensors/actuators and the PLC

Information about ...	is available in the manual ...	In Section ...
Which module is suitable for my sensor/actuator?	<ul style="list-style-type: none"> • CPU 31xC and CPU 31x: Technical Data • For your signal module 	Technical Data
How many sensors/actuators can I connect to the module?	<ul style="list-style-type: none"> • CPU 31xC and CPU 31x: Technical Data • For your signal module 	Technical Data
How do I connect my sensors/actuators to the automation system, using the front connector?	CPU 31xC and CPU 31x: Installation	Wiring – Wiring the front connector
When do I need expansion modules (EM) and how do I connect them?	CPU 31xC and CPU 31x: Installation	Configuring – Distribution of modules to several racks
How do I mount modules on racks / mounting rails?	CPU 31xC and CPU 31x: Installation	Assembly – Installing modules on the mounting rail

The use of local and distributed IOs

Information about ...	is available in the manual ...	In Section ...
Which range of modules do I want to use?	<ul style="list-style-type: none"> • Module data (for centralized IOs and expansion devices) • of the respective peripheral (for distributed IOs / PROFIBUS DP) 	–

Configuration consisting of the central controller and expansion units

Information about ...	is available in the manual ...	In Section ...
Which rack / mounting rail is most suitable for my application?	CPU 31xC and CPU 31x: Installation	Configuring
Which interface modules (IM) do I need to connect the expansion units to the central controller?	CPU 31xC and CPU 31x: Installation	Configuring – Distribution of modules to several racks
What is the right power supply (PS) for my application?	CPU 31xC and CPU 31x: Installation	Configuring

CPU performance

Information about ...	is available in the manual ...	In Section ...
Which memory concept is best suited to my application?	CPU 31xC and CPU 31x: Technical Data	Memory concept
How do I insert and remove Micro Memory Cards?	CPU 31xC and CPU 31x: Installation	Commissioning – Commissioning modules – Removing / inserting a Micro Memory Card (MMC)
Which CPU meets my demands on performance?	S7-300 instruction list: CPU 31xC and CPU 31x	–
Length of the CPU response / execution times	CPU 31xC and CPU 31x: Technical Data	–
Which technological functions are implemented?	Technological functions	–
How can I use these technological functions?	Technological functions	–

Communication

Information about ...	is available in the manual ...	In Section ...
Which principles do I have to take into account?	<ul style="list-style-type: none"> • CPU 31xC and CPU 31x: Technical Data • Communication with SIMATIC • PROFINET System Description 	Communication
Options and resources of the CPU	CPU 31xC and CPU 31x: Technical Data	Technical Data
How to use communication processors (CPs) to optimize communication	CP Manual	–
Which type of communication network is best suited to my application?	CPU 31xC and CPU 31x: Installation	Configuring – Configuring subnets
How do I network the various components?	CPU 31xC and CPU 31x: Installation	Configuring – Configuring subnets
What to take into account when configuring PROFINET networks	SIMATIC NET, twisted-pair and fiber-optic networks (6GK1970-1BA10-0AA0)	Network configuration
	PROFINET System Description	Installation and commissioning

Software

Information about ...	is available in the manual ...	In Section ...
Software requirements of my S7-300 system	CPU 31xC and CPU 31x: Technical Data	Technical Data

Supplementary features

Information about ...	is available in ...
How can I implement operation and monitoring functions? (Human Machine Interface)	The relevant Manual: <ul style="list-style-type: none">• For text-based displays• For Operator Panels• For WinCC
How to integrate process control modules	Respective PCS7 manual
What options are offered by redundant and fail-safe systems?	S7-400H – Fault-Tolerant Systems Failsafe systems
Information to be observed when migrating from PROFIBUS DP to PROFINET IO	From PROFIBUS DP to PROFINET IO

Operating and display elements

2.1 Operating and display elements: CPU 31xC

2.1.1 Operating and display elements: CPU 31xC

Operating and display elements of CPU 31xC

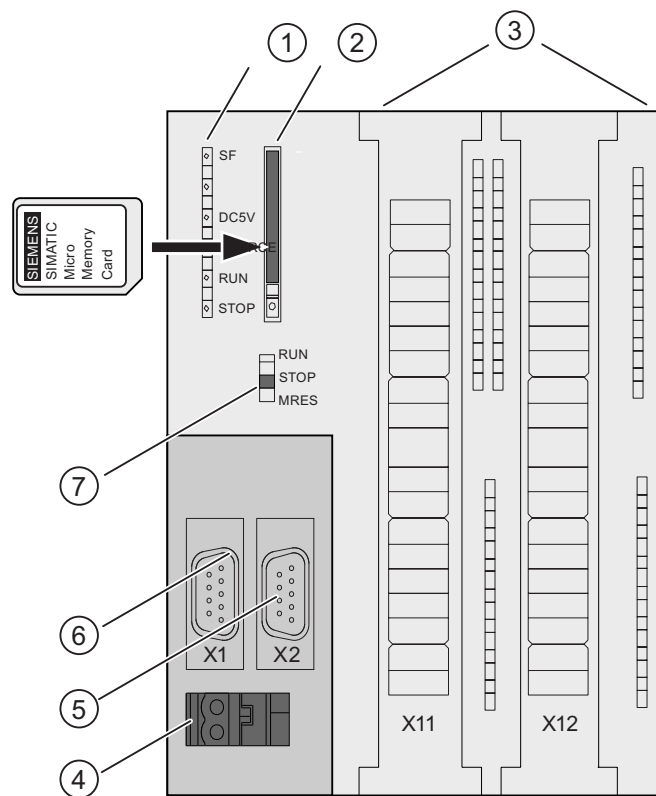

Number	Designation
①	Status and error displays
②	Slot for the SIMATIC Micro Memory Card incl. the ejector
③	Connections of the integrated I/O.
④	Power supply connection
⑤	2. Interface X2 (PtP or DP)
⑥	1. Interface X1 (MPI)
⑦	Mode selector switch

The figure below illustrates the integrated digital and analog I/Os of the CPU with open front covers.

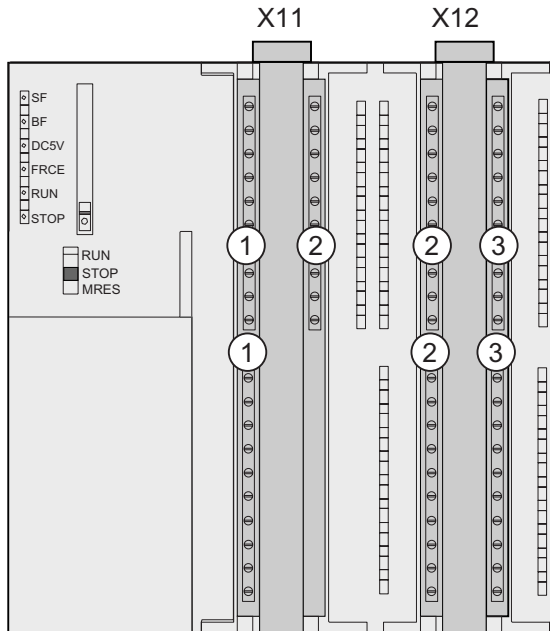

Number	Designation
①	Analog I/Os
②	each with 8 digital inputs
③	each with 8 digital outputs

Slot for the SIMATIC Micro Memory Card

Memory module is a SIMATIC Micro Memory Card. You can use an MMC as a load memory and as a portable data carrier.

Note

These CPUs do not have an integrated load memory and thus require a SIMATIC Micro Memory Card for operation.

Mode selector switch

Use the mode selector switch to set the CPU operating mode.

Table 2- 1 Mode selector switch settings

Position	Meaning	Description
RUN	RUN mode	The CPU executes the user program.
STOP	STOP mode	The CPU does not execute a user program.
MRES	CPU memory reset	Mode selector switch position with pushbutton function for CPU memory reset. A CPU memory reset by means of mode selector switch requires a specific sequence of operation.

Reference

- CPU operating modes: *STEP 7 Online Help*.
- Information on CPU memory reset: *Operating instructions CPU 31xC and CPU31x, Commissioning, Commissioning Modules, CPU Memory Reset by means of Mode Selector Switch*
- Evaluation of the LEDs upon error or diagnostic event: *Operating Instructions CPU 31xC and CPU 31x, Test Functions, Diagnostics and Troubleshooting, Diagnostics with the help of Status and Error LEDs*

Power supply connection

Each CPU is equipped with a double-pole power supply socket. The connector with screw terminals is inserted into this socket when the CPU is delivered.

Differences between the CPUs

Table 2- 2 Differences of the CPUs 31xC

Element	CPU 312C	CPU 313C	CPU 313C-2 DP	CPU 313C-2 PtP	CPU 314C-2 DP	CPU 314C-2 PtP
9-pole DP interface (X2)	–	–	X	–	X	–
15-pole PtP interface (X2)	–	–	–	X	–	X
Digital inputs	10	24	16	16	24	24
Digital outputs	6	16	16	16	16	16
Analog inputs	–	4 + 1	–	–	4 + 1	4 + 1
Analog outputs	–	2	–	–	2	2
Technological functions	2 counters	3 counters	3 counters	3 counters	4 counters 1 channel for positioning	4 counters 1 channel for positioning

2.1.2 Status and error indicators: CPU 31xC

LED designation	Color	Meaning
SF	Red	Hardware or software error
BF (for CPUs with DP interface only)	Red	Bus error
DC5V	Green	5-V power for CPU and S7-300 bus is OK
FRCE	Yellow	Force job is active
RUN	Green	CPU in RUN The LED flashes during STARTUP at a rate of 2 Hz, and in HOLD state at 0.5 Hz.
STOP	Yellow	CPU in STOP and HOLD or STARTUP The LED flashes at 0.5 Hz when the CPU requests a memory reset, and during the reset at 2 Hz.

Reference

- CPU operating modes: *STEP 7 Online Help*.
- Information on CPU memory reset: *Operating instructions CPU 31xC and CPU31x, Commissioning, Commissioning Modules, CPU Memory Reset by means of Mode Selector Switch*
- Evaluation of the LEDs upon error or diagnostic event: *Operating Instructions CPU 31xC and CPU 31x, Test Functions, Diagnostics and Troubleshooting, Diagnostics with the help of Status and Error LEDs*

2.2 Operating and display elements: CPU 31x

2.2.1 Operating and display elements: CPU 312, 314, 315-2 DP:

Operating and display elements

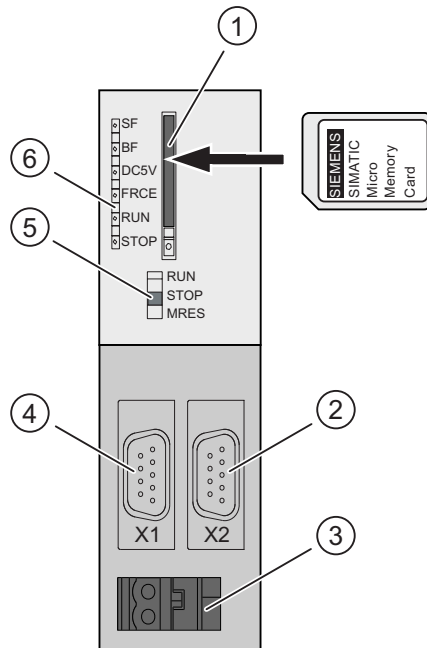

Number	Designation
①	Slot for the SIMATIC Micro Memory Card incl. the ejector
②	2. Interface X2 (only for CPU 315-2 DP)
③	Power supply connection
④	1. Interface X1 (MPI)
⑤	Mode selector switch
⑥	Status and error displays

Slot for the SIMATIC Micro Memory Card

Memory module is a SIMATIC Micro Memory Card. You can use an MMC as a load memory and as a portable data carrier.

Note

These CPUs do not have an integrated load memory and thus require a SIMATIC Micro Memory Card for operation.

Mode selector switch

The mode selector switch is used to set the CPU operating mode.

Table 2- 3 Mode selector switch settings

Position	Meaning	Description
RUN	RUN mode	The CPU executes the user program.
STOP	STOP mode	The CPU does not execute a user program.
MRES	CPU memory reset	Mode selector switch position with pushbutton function for CPU memory reset. A CPU memory reset by means of mode selector switch requires a specific sequence of operation.

Reference

- CPU operating modes: *STEP 7 Online Help*.
- Information on CPU memory reset: *Operating instructions CPU 31xC and CPU31x, Commissioning, Commissioning Modules, CPU Memory Reset by means of Mode Selector Switch*
- Evaluation of the LEDs upon error or diagnostic event: *Operating Instructions CPU 31xC and CPU 31x, Test Functions, Diagnostics and Troubleshooting, Diagnostics with the help of Status and Error LEDs*

Power supply connection

Each CPU is equipped with a 2-pole power supply socket. The connector with screw terminals is inserted into this socket when the CPU is delivered.

2.2.2 Operating and display elements: CPU 317-2 DP

Operating and display elements

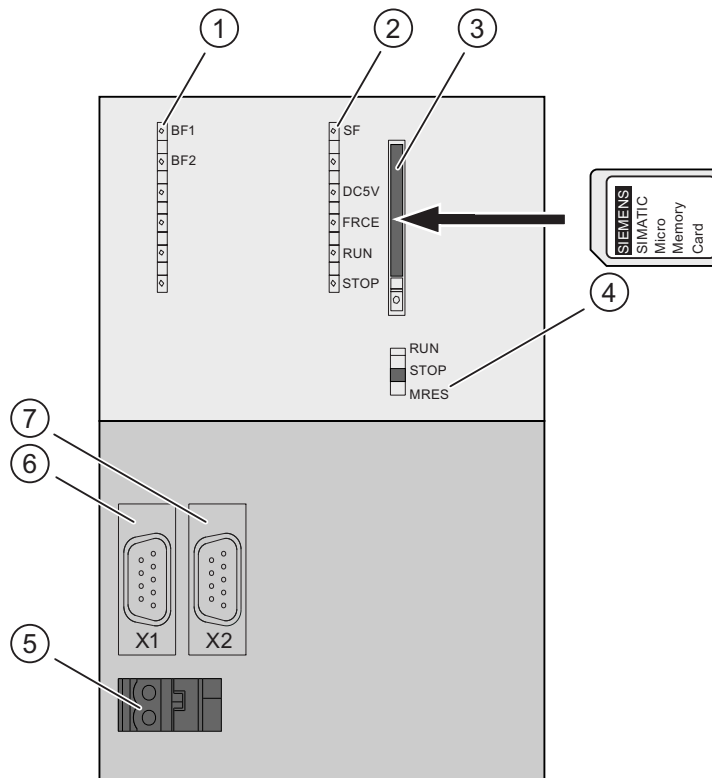

Number	Description
①	Bus error indicators
②	Status and error displays
③	Slot for the SIMATIC Micro Memory Card incl. the ejector
④	Mode selector switch
⑤	Power supply connection
⑥	1. Interface X1 (MPI/DP)
⑦	2. Interface X2 (DP)

Slot for the SIMATIC Micro Memory Card

Memory module is a SIMATIC Micro Memory Card. You can use an MMC as a load memory and as a portable data carrier.

Note

These CPUs do not have an integrated load memory and thus require a SIMATIC Micro Memory Card for operation.

Mode selector switch

Use the mode selector switch to set the CPU operating mode.

Table 2- 4 Mode selector switch settings

Position	Meaning	Description
RUN	RUN mode	The CPU executes the user program.
STOP	STOP mode	The CPU does not execute a user program.
MRES	CPU memory reset	Mode selector switch position with pushbutton function for CPU memory reset. A CPU memory reset by means of mode selector switch requires a specific sequence of operation.

Reference

- CPU operating modes: *STEP 7 Online Help*.
- Information on CPU memory reset: *Operating instructions CPU 31xC and CPU31x, Commissioning, Commissioning Modules, CPU Memory Reset by means of Mode Selector Switch*
- Evaluation of the LEDs upon error or diagnostic event: *Operating Instructions CPU 31xC and CPU 31x, Test Functions, Diagnostics and Troubleshooting, Diagnostics with the help of Status and Error LEDs*

Power supply connection

Each CPU is equipped with a 2-pole power supply socket. The connector with screw terminals is inserted into this socket when the CPU is delivered.

2.2.3 Operating and display elements: CPU 31x-2 PN/DP

Operating and display elements

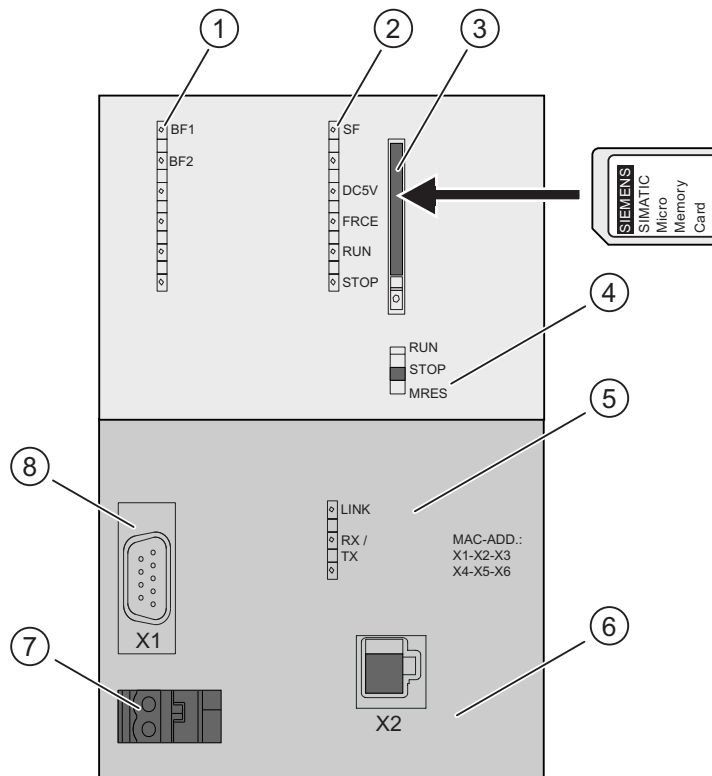

Number	Description
①	Bus error indicators
②	Status and error displays
③	Slot for the SIMATIC Micro Memory Card incl. the ejector
④	Mode selector switch
⑤	Status display of 2nd interface (X2)
⑥	2. Interface X2 (PN)
⑦	Power supply connection
⑧	1. Interface X1 (MPI/DP)

Slot for the SIMATIC Micro Memory Card

Memory module is a SIMATIC Micro Memory Card. You can use an MMC as a load memory and as a portable data carrier.

Note

These CPUs do not have an integrated load memory and thus require a SIMATIC Micro Memory Card for operation.

Mode selector switch

You can use the mode selector switch to set the current operating mode of the CPU.

Table 2- 5 Mode selector switch settings

Position	Meaning	Description
RUN	RUN mode	The CPU executes the user program.
STOP	STOP mode	The CPU does not execute a user program.
MRES	CPU memory reset	Mode selector switch position with pushbutton function for CPU memory reset. A CPU memory reset by means of mode selector switch requires a specific sequence of operation.

Reference

- CPU operating modes: *STEP 7 Online Help*.
- Information on CPU memory reset: *Operating instructions CPU 31xC and CPU31x, Commissioning, Commissioning Modules, CPU Memory Reset by means of Mode Selector Switch*
- Evaluation of the LEDs upon error or diagnostic event: *Operating Instructions CPU 31xC and CPU 31x, Test Functions, Diagnostics and Troubleshooting, Diagnostics with the help of Status and Error LEDs*

Power supply connection

Each CPU is equipped with a 2-pole power supply socket. The connector with screw terminals is inserted into this socket when the CPU is delivered.

2.2.4 Operating and display elements: CPU 319-3 PN/DP

Operating and display elements

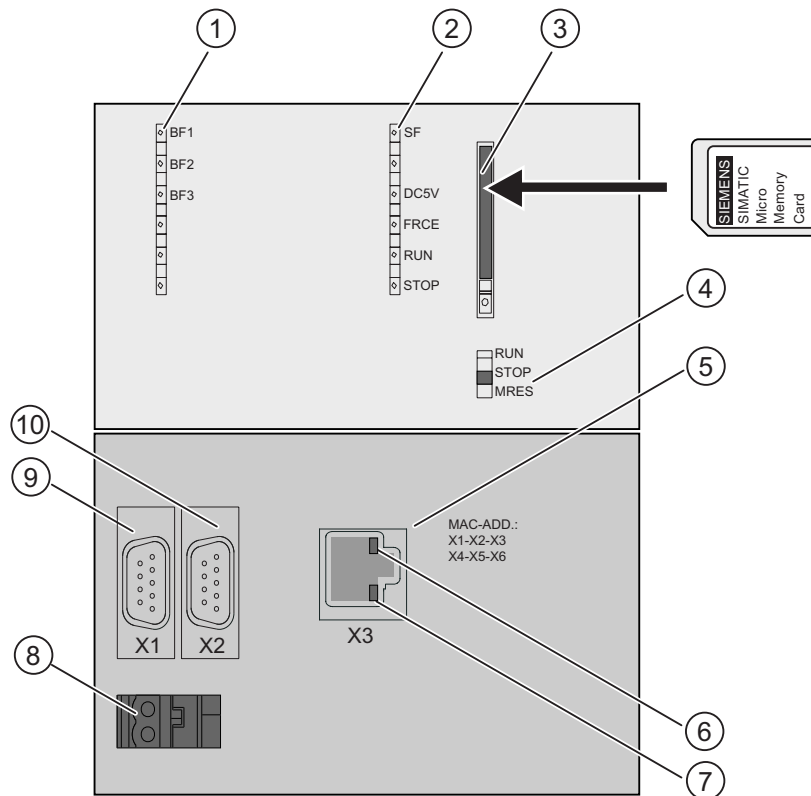

Number	Designation
①	Bus error indicators
②	Status and error displays
③	Slot for the SIMATIC Micro Memory Card incl. the ejector
④	Mode selector switch
⑤	3. Interface X3 (PN)
⑥	Green LED (LED designation: LINK)
⑦	Yellow LED (LED designation: RX/TX)
⑧	Power supply connection
⑨	1. Interface X1 (MPI/DP)
⑩	2. Interface X2 (DP)

Slot for the SIMATIC Micro Memory Card

Memory module is a SIMATIC Micro Memory Card. You can use an MMC as a load memory and as a portable data carrier.

Note

These CPUs do not have an integrated load memory and thus require a SIMATIC Micro Memory Card for operation.

Mode selector switch

You can use the mode selector switch to set the current operating mode of the CPU.

Table 2- 6 Mode selector switch settings

Position	Meaning	Description
RUN	RUN mode	The CPU executes the user program.
STOP	STOP mode	The CPU does not execute a user program.
MRES	CPU memory reset	Mode selector switch position with pushbutton function for CPU memory reset. A CPU memory reset by means of mode selector switch requires a specific sequence of operation.

Reference

- CPU operating modes: *STEP 7 Online Help*.
- Information on CPU memory reset: *Operating instructions CPU 31xC and CPU31x, Commissioning, Commissioning Modules, CPU Memory Reset by means of Mode Selector Switch*
- Evaluation of the LEDs upon error or diagnostic event: *Operating Instructions CPU 31xC and CPU 31x, Test Functions, Diagnostics and Troubleshooting, Diagnostics with the help of Status and Error LEDs*

Power supply connection

Each CPU is equipped with a 2-pole power supply socket. The connector with screw terminals is inserted into this socket when the CPU is delivered.

2.2.5 Status and error displays of CPU 31x

General status and error displays

Table 2- 7 General status and error displays of the CPU 31x

LED designation	Color	Meaning
SF	red	Hardware or software error.
DC5V	green	5-V power for the CPU and the S7-300 bus
FRCE	yellow	LED is lit: Active force job LED flashes at 2 Hz: Node flash test function
RUN	green	CPU in RUN The LED flashes during STARTUP at a rate of 2 Hz, and in HOLD state at 0.5 Hz.
STOP	yellow	CPU in STOP, or HOLD, or STARTUP The LED flashes at 0.5 Hz when the CPU requests a memory reset, and during the reset at 2 Hz.

Status displays for the interfaces X1, X2 and X3

Table 2- 8 Bus error displays of CPU 31x

CPU	LED designation	Color	Meaning
315-2 DP	BF	red	Bus error at DP interface (X2)
317-2 DP	BF1:	red	Bus error at first interface (X1)
	BF2:	red	Bus error at second interface (X2)
31x-2 PN/DP	BF1:	red	Bus error at first interface (X1)
	BF2:	red	Bus error at second interface (X2)
	LINK	green	Connection at second interface (X2) is active
	RX/TX	yellow	Receive / Transmit data at second interface (X2)
319-3 PN/DP	BF1:	red	Bus error at first interface (X1)
	BF2:	red	Bus error at second interface (X2)
	BF3:	red	Bus error at third interface (X3)
	LINK ¹	green	Connection at third interface (X3) is active
	RX/TX ¹	yellow	Receive / transmit data at third interface (X3)

¹ The LEDs are located directly at the RJ45 socket in the case of the CPU 319-3 PN/DP, they are not labeled!

Reference

- CPU operating modes: *STEP 7 Online Help*.
- Information on CPU memory reset: *Operating instructions CPU 31xC and CPU31x, Commissioning, Commissioning Modules, CPU Memory Reset by means of Mode Selector Switch*
- Evaluation of the LEDs upon error or diagnostic event: *Operating Instructions CPU 31xC and CPU 31x, Test Functions, Diagnostics and Troubleshooting, Diagnostics with the help of Status and Error LEDs*

Communication

3.1 Interfaces

3.1.1 Multi-Point Interface (MPI)

Availability

All the CPUs described here are equipped with an MPI interface

A CPU equipped with an MPI/DP interface is configured and supplied as MPI interface.

Properties

The MPI (Multi-Point Interface) represents the CPU interface for PG/OP connections, or for communication on an MPI subnet.

The default transmission rate of all CPUs is 187.5 kbps. You can also set 19.2 kbps for communication with an S7-200. The 315-2 PN/DP, 317-2 and 319-3 PN/DP CPUs support transmission rates to 12 Mbps.

The CPU automatically broadcasts its bus configuration via the MPI interface (the transmission rate, for example). A PG, for example, can thus receive the correct parameters and automatically connect to a MPI subnet.

Devices capable of MPI communication

- PG/PC
- OP/TP
- S7-300 / S7-400 with MPI interface
- S7-200 (only at 19.2 kbps)

NOTICE

You may only connect PGs to an MPI subnet which is in RUN.
Do not connect other stations (for example, OP, TP) to the MPI subnet while the system is running. Otherwise, transferred data might be corrupted as a result of interference, or global data packages may be lost.

Clock synchronization

The CPU's MPI interface supports clock synchronization. The CPU can be programmed for operation as time-of-day master (with default synchronization intervals) or slave clock.

Default setting: No clock synchronization

The synchronization mode is set in the "Clock" tab of the CPU or interface properties dialog box in HW Config.

CPU as a time slave

When operated as a slave clock, the CPU receives a synchronization message frame from exactly one time-of-day master and sets its internal time accordingly.

CPU as a time master

When operated as time-of-day master, the CPU broadcasts clock synchronization message frames at programmed synchronization intervals at the MPI interface to other node stations of the MPI subnet.

Condition: The CPU real-time clock may no longer be in the default state. It has to be set once.

Note

The real-time clock of the CPU is not yet set in the state of delivery or after resetting to the state of delivery using the mode selector or after a firmware update.

The clock synchronization starts as a time-of-day master:

- As soon as you have set the time the first time using SFC 0 "SET_CLK" or the programming device function.
- By another time-of-day master if the CPU is also parameterized as a slave clock using the MPI/DP or PROFINET interface.

Interfaces for clock synchronization

Clock synchronization is possible at the following interfaces:

- At the MPI Interface
- At the DP Interface
- At the PROFINET Interface
- In the automation system of the central configuration

Note

The CPU may only be operated as time slave at one of these interfaces.

Example 1

A CPU operating as a slave clock on the DP interface can only operate as a time-of-day master on the MPI interface and/or within the automation system.

Example 2

If the CPU time is already synchronized through clock synchronization by means of a PROFINET interface via NTP (corresponds to the functionality as a slave clock), the CPU can only be operated as a time-of-day master at the DP interface and/or the MPI interface within the automation system.

3.1.2 PROFIBUS DP

Availability

CPUs with the "DP" have at least one DP interface.

The 315-2 PN/DP and 317-2 PN/DP CPUs feature an integrated MPI/DP interface. The 317-2 DP and 319-3 PN/DP CPUs feature an MPI/DP interface plus an additional DP interface. The factory setting of the CPU's MPI/DP interface is MPI mode. You need to set DP mode in STEP 7 if you want to use the DP interface.

Operating modes for CPUs with two DP interfaces

Table 3- 1 Operating modes for CPUs with two DP interfaces

MPI/DP interface	PROFIBUS DP interface
<ul style="list-style-type: none">• MPI• DP master• DP slave ¹⁾	<ul style="list-style-type: none">• not configured• DP master• DP slave ¹⁾

¹⁾ simultaneous operation of the DP slave on both interfaces is excluded

Properties

The PROFIBUS DP interface is mainly used to connect distributed I/O. PROFIBUS DP allows you to create large subnets, for example.

The PROFIBUS DP interface can be set for operation in master or slave mode, and supports transmission rates up to 12 Mbps.

The CPU broadcasts its bus parameters (transmission rate, for example) via the PROFIBUS DP interface when master mode is set. This functionality automatically provides the correct parameters for online operation of a programming device, for example. In your configuration you can specify to disable bus parameter broadcasting.

Note

(for DP interface in slave mode only)

When you disable the "Test, Commissioning, Routing" check box in the DP interface properties dialog box in STEP 7, the transmission rate settings of the master automatically override corresponding user-specific settings. This disables the routing function at this interface.

Devices capable of PROFIBUS DP communication

- PG/PC
- OP/TP
- DP slaves
- DP master
- Actuators/Sensors
- S7-300/S7-400 with PROFIBUS DP interface

Clock synchronization

The CPU's DP interface supports clock synchronization. The CPU can be programmed for operation as time master (with default synchronization intervals) or time slave.

Default setting: No clock synchronization

The synchronization mode is set in the "Clock" tab of the interface properties dialog box in HW Config.

CPU as a time slave

When operated as a slave clock, the CPU receives a synchronization message frame from exactly one time-of-day master and sets its internal time accordingly.

CPU as a time master

When operated as time-of-day master, the CPU broadcasts clock synchronization message frames at programmed synchronization intervals at the DP interface to other node stations of the DP subnet.

Condition: The CPU real-time clock may no longer be in the default state. It has to be set once.

Note

The real-time clock of the CPU is not yet set in the state of delivery or after resetting to the state of delivery using the mode selector or after a firmware update.

The clock synchronization starts as a time-of-day master:

- As soon as you have set the time the first time using SFC 0 "SET_CLK" or the programming device function.
- By another time-of-day master if the CPU is also parameterized as a slave clock using the MPI/DP or PROFINET interface.

Interfaces for clock synchronization

Clock synchronization is possible at the following interfaces:

- At the MPI Interface
- At the DP Interface
- At the PROFINET Interface
- In the automation system of the central configuration

Note

The CPU may only be operated as a slave clock at one of these interfaces.

Example 1

A CPU operating as a slave clock on the DP interface can only operate as a time-of-day master on the MPI interface and/or within the automation system.

Example 2

If the CPU time is already synchronized through clock synchronization by means of a PROFINET interface via NTP (corresponds to the functionality as a slave clock), the CPU can only be operated as a time-of-day master at the DP interface and/or the MPI interface within the automation system.

Reference

Further information on the PROFIBUS can be found on the Internet (<http://www.profibus.com>).

3.1.3 PROFINET

Availability

CPUs with a "PN" name suffix are equipped with a PROFINET interface.

Connecting to Industrial Ethernet

You can use the integrated PROFINET interface of the CPU to establish a connection to Industrial Ethernet.

The integrated PROFINET interface of the CPU can be configured via MPI or PROFINET interface.

Clock synchronization using PROFINET

The CPU can be operated on the PROFINET interface as time client based on NTP (Network Time Protocol).

Default setting: No clock synchronization based on NTP

Set the "Clock synchronization based on NTP" option to synchronize the CPU on PROFINET. This option is available in the "Clock synchronization" properties of the PROFINET interface. Also enter the IP addresses of the NTP server and a synchronization interval.

Information on suitable NTP servers and on NTP is available, for example, at contribution ID: 17990844.

In addition to the PROFINET interface, the system also supports clock synchronization on the MPI or DP interface. The CPU clock may only be synchronized by a time master or server.

Example

The time of CPU 319-3 PN/DP is synchronized by a clock synchronization on PROFINET over NTP. This configuration only allows operation of the CPU as time master on the DP and/or MPI interface within the AS.

Note

The PROFINET interface cannot be operated as time server, that is, the CPU cannot synchronize any other clocks on PROFINET.

Devices capable of PROFINET (PN) communication

- PROFINET IO devices (for example, interface module IM 151-3 PN in an ET 200S)
- PROFINET CBA components
- S7-300 / S7-400 with PROFINET interface (for example, CPU 317-2 PN/DP or CP 343-1)
- Active network components (a switch, for example)
- PG/PC with Ethernet card
- IE/PB Link

Properties of the PROFINET interface

Properties	
IEEE standard	802.3
Connector design	RJ45
Transmission speed	100 Mbps max.
Media	Twisted Pair Cat5 (100BASE-TX)

Note

Networking PROFINET components

The use of switches, rather than hubs, for networking PROFINET components brings about a substantial improvement in decoupling bus traffic, and improves runtime performance under higher bus load. PROFINET CBA with cyclic PROFINET interconnections requires the use of switches in order to maintain compliance with performance specifications. Full duplex mode at 100 Mbps is mandatory for cyclic PROFINET interconnections.

PROFINET IO also requires the use of switches and 100 Mbps full duplex mode. In the case of a PROFINET IO in IRT operation, all the PROFINET devices, also the switches, must be IRT-capable in the synchronization domain.

Addressing ports

Each port of a PROFINET interface requires a separate diagnostics address. Programming the addresses in HW Config.

For further information, refer to the *PROFINET System Description System Manual*.

Diagnostics messages (error and maintenance information) for reporting problems detected in the user program can be enabled at OB 82 (enable set in HW Config) and evaluated, for example, by calling SFB 54. The system also supports extended diagnostics by providing diverse data records read by calling SFB 52 and SSLs (System Status Lists) which you can read by calling SFC 51.

Diagnostics is also possible in *STEP 7* (e.g. communication diagnostics, network connection, Ethernet statistics, IP parameters).

Send clock and update time

Controllers and devices can be operated on a PROFINET IO subnet at a synchronized send clock. A higher send clock of a controller is adapted appropriately for devices which do not support this rate. That is, you could operate devices both at a send clock of 250 μ s and 1 ms on a 319-3 PN/DP CPU (IO controller) which operates at a send clock of 250 μ s.

You can program the update time of devices within a relatively wide range. This again depends on the send clock. The following send cycles can be configured:

Send clock		Update time	CPU 315-2 PN/DP	CPU 317-2 PN/DP	CPU 319-3 PN/DP
250 μ s	=>	250 μ s to 128 ms			X
500 μ s	=>	500 μ s to 256 ms			X
1 ms	=>	1 ms to 512 ms	X	X	X

The minimum update time is determined by the number of IO devices used, by the volume of configured user data, and by the time slice for PROFINET IO communication. *STEP 7* automatically makes allowances for these dependencies in your system configuration.

Reference

- For instructions on how to configure the integrated PROFINET interface, refer to *S7-300, CPU 31xC and CPU 31x operating instructions (Setup)*.
- For additional information on PROFINET, refer to *PROFINET System Description*.
This also contains the descriptions for the functionalities:
 - Real-time communication (RT and IRT)
 - Device replacement without removable medium
 - Prioritized startup for IO devices
 - Changing IO devices during operation (changing partner ports)
- For detailed information on Ethernet networks, network configuration and network components refer to the *SIMATIC NET Manual: Twisted Pair and Fiber-Optic Networks*, on the Internet (<http://support.automation.siemens.com/WW/view/en/8763736>).
- For detailed information on CBA refer to the *Tutorial Component Based Automation, Commissioning Systems* on the Internet (<http://support.automation.siemens.com/WW/view/en/18403908>).
- Further information about the PROFINET can be found on the Internet (<http://www.profibus.com>).

3.1.3.1 Configuring the port properties

Configuring the port properties of the PROFINET interface in *STEP 7*

The PROFINET interfaces in our devices are preset to a default "automatic setting" (Autonegotiation). Please ensure that all devices connected to the PROFINET interface of the CPU 319-3 PN/DP are also set to the "Autonegotiation" operating mode. This is the default setting of standard PROFINET / Ethernet components.

If you connect a device to the PROFINET interface of the CPU 319-3 PN/DP that does not support the "automatic setting" (Autonegotiation) operating mode, or if you select a setting in addition to the "automatic setting" (Autonegotiation), note the following:

- PROFINET IO and PROFINET CBA require operation with 100 Mbps full-duplex, i.e. when the PROFINET interface of the CPU 319-3 PN/DP for PROFINET IO / CBA communication and Ethernet communication is used at the same time, the interface may only be set to 100 Mbps full-duplex in addition to the "automatic setting (Autonegotiation).
- If the PROFINET interface of the 319-3 PN/DP is used only for Ethernet communication, 100 Mbps full-duplex or 10 Mbps full-duplex is still possible in addition to the "automatic setting" (Autonegotiation). Setting half-duplex mode is not allowed in any situation.

Reason: If, for example, a switch permanently set to 10 Mbps half-duplex is connected to the PROFINET interface of the CPU 319-3 PN/DP, the CPU 319-3 PN/DP adapts itself to the setting to the partner device due to the "Autonegotiation" setting - i.e. the communication operates de facto with "10 Mbps half-duplex".

However, since PROFINET IO and PROFINET CBA require operation with 100 Mbps full-duplex, this operating mode is not allowed.

Note

For further information about configuring the ports of IO devices that are to carry out a prioritized startup, refer to the special notes in the *PROFINET System Description*.

Deactivating a port of the PROFINET interface at a CPU 319-3 PN/DP

In *STEP 7* HW Config a port of the PROFINET interface of a CPU 319-3 PN/DP can be deactivated. By default it is activated.

The CPU 319-3 PN/DP cannot be reached through a deactivated port of the PROFINET interface.

Take into account that no communication functions such as programming device / OP functions, open IE communication or S7 communication are possible through a deactivated port.

Addressing the ports

To diagnose the individual ports of a PROFINET interface, these ports must each have a separate diagnostic address. The addressing is done in HW Config. For further information, refer to the *PROFINET System Description*.

Diagnostics messages (error and maintenance information) for reporting problems detected in the user program can be enabled at OB 82 (enable set in HW Config) and evaluated, for example, by calling SFB 54. There are also various data records (read using SFB 52) and system status lists (read using SFC 51) provided for more detailed diagnostics.

Diagnostics is also possible in *STEP 7* (e.g. communication diagnostics, network connection, Ethernet statistics, IP parameters, etc).

3.1.4 Point to Point (PtP)

Availability

CPUs with the "PtP" name suffix have at least one PtP interface.

Features

Using the PtP interface of your CPU, you can connect external devices with serial interface. You can operate such a system at transmission rates up to 19.2 kbps in full duplex mode (RS 422), and up to 38.4 kbps in half duplex mode (RS 485).

Transmission rate

- Half duplex: 38.4 kbps
- Full duplex: 19.2 kbps

Drivers

PtP communication drivers installed in those CPUs:

- ASCII drivers
- 3964(R) Protocol
- RK 512 (CPU 314C-2 PtP only)

Devices capable of PtP communication

Devices equipped with a serial port, for example, barcode readers, printers, etc.

Reference

CPU 31xC: Technological functions manual

3.2 Communication services

3.2.1 Overview of communication services

Selecting the communication service

You need to decide on a communication service, based on functionality requirements. Your choice of communication service will have no effect on:

- the functionality available,
- whether an S7 connection is required or not, and
- the time of connecting.

The user interface can vary considerably (SFC, SFB, ...), and is also determined by the hardware used (SIMATIC CPU, PC, ...).

Overview of communication services

The table below provides an overview of communication services offered by the CPUs.

Table 3- 2 Communication services of the CPUs

Communication service	Functionality	Time at which the S7 connection is established ...	via MPI	via DP	via PtP	via PN
PG communication	Commissioning, test, diagnostics	From the PG, starting when the service is being used	X	X	–	X
OP communication	Monitor and modify	Via OP at POWER ON	X	X	–	X
S7 basic communication	Data exchange	Is programmed at the blocks (SFC parameters)	X	X	–	–
S7 communication	Data exchange in server and client mode: Configuration of communication required.	Via active partner at POWER ON.	Only in server mode	Only in server mode	–	X
Global data communication	Cyclic data exchange (for example, flag bits)	Does not require an S7 connection	X	–	–	–
Routing PG functions (only for CPUs with DP or PROFINET interface)	For example testing, diagnostics on other networks also	From the PG, starting when the service is being used	X	X	–	X
Point-to-point connection	Data exchange via serial interface	Does not require an S7 connection	–	–	X	–
PROFIBUS DP	Data exchange between master and slave	Does not require an S7 connection	–	X	–	–
PROFINET CBA	Data exchange by means of component based communication	Does not require an S7 connection	–	–	–	X

Communication service	Functionality	Time at which the S7 connection is established ...	via MPI	via DP	via PtP	via PN
PROFINET IO	Data exchange between IO controllers and the IO devices	Does not require an S7 connection	–	–	–	X
Web Server	Diagnostics	Does not require an S7 connection	–	–	–	X
SNMP (Simple Network Management Protocol)	Standard protocol for network diagnostics and configuration	Does not require an S7 connection	–	–	–	X
Open communication via TCP/IP	Data exchange via Industrial Ethernet with TCP/IP protocol (by means of loadable FBs)	Does not require an S7 connection, is handled in the user program by means of loadable FBs	–	–	–	X
Open communication by means of ISO on TCP	Data exchange via Industrial Ethernet with ISO-on-TCP protocol (by means of loadable FBs)	Does not require an S7 connection, is handled in the user program by means of loadable FBs	–	–	–	X
Open communication by means of UDP	Data exchange via Industrial Ethernet with UDP protocol (by means of loadable FBs)	Does not require an S7 connection, is handled in the user program by means of loadable FBs	–	–	–	X

See also

Distribution and availability of S7 connection resources (Page 97)

Connection resources for routing (Page 99)

3.2.2 PG communication

Features

PG communication is used to exchange data between engineering stations (PG, PC, for example) and SIMATIC modules which are capable of communication. This service is available for MPI, PROFIBUS and Industrial Ethernet subnets. Transition between subnets is also supported.

PG communication provides the functions needed to download / upload programs and configuration data, to run tests and to evaluate diagnostic information. These functions are integrated in the operating system of SIMATIC S7 modules.

A CPU can maintain several simultaneous online connections to one or multiple PGs.

3.2.3 OP communication

Features

OP communication is used to exchange data between operator stations (OP, TP, for example) and SIMATIC modules which are capable of communication. This service is available for MPI, PROFIBUS and Industrial Ethernet subnets.

OP communication provides functions you require for monitoring and modifying. These functions are integrated in the operating system of SIMATIC S7 modules. A CPU can maintain several simultaneous connections to one or several OPs.

3.2.4 Data exchanged by means of S7 basic communication

Properties

S7-based communication is used to exchange data between S7 CPUs and the communication-capable SIMATIC modules within an S7 station (acknowledged data exchange). Data are exchanged across non-configured S7 connections. The service is available via MPI subnet, or within the station to function modules (FM).

S7-based communication provides the functions you require for data exchange. These functions are integrated into the CPU operating system. The user can utilize this service by means of "System function" (SFC) user interface.

Reference

Further Information

- on SFCs, refer to *Instruction list*.
For further information refer to *STEP 7 Online Help* or *System and Standard Functions* reference manual.
- on communication are found in the *Communication with SIMATIC* Manual.

3.2.5 S7 communication

Properties

A CPU can always operate in server or client mode in S7 communication: We distinguish between

- communication with unilateral configuration (for PUT/GET only)
- communication with bilateral configuration (for USEND, URCV, BSEND, BRCV, PUT, GET)

However, the functionality depends on the CPU. A CP is therefore required in certain situations.

Table 3- 3 Client and server in S7 communication, using connections with unilateral / bilateral configuration

CPU	Use in server mode for connections with unilateral configuration	Use in server mode for connections with bilateral configuration	Use as client
31xC >= V1.0.0	Generally possible on MPI/DP interface without configuration of user interface	Only possible with CP and loadable FBs.	Only possible with CP and loadable FBs.
31x >= V2.0.0	Generally possible on MPI/DP interface without configuration of user interface	Only possible with CP and loadable FBs.	Only possible with CP and loadable FBs.
31x >= V2.2.0	Generally possible on MPI/DP/PN interface without configuration of user interface	<ul style="list-style-type: none"> • Possible on PROFINET interface with loadable FBs or • with CP and loadable FBs. 	<ul style="list-style-type: none"> • Possible on PROFINET interface with loadable FBs or • with CP and loadable FBs.

The user interface is implemented using standard function modules (FBs) from the standard library of STEP 7, under communication blocks.

Reference

For further information on communication, refer to the *Communication with SIMATIC* manual.

3.2.6 Global data communication (MPI only)

Properties

Global data communication is used for cyclic exchange of global data via MPI subnets (for example, I, Q, M) between SIMATIC S7 CPUs (data exchange without acknowledgement). One CPU broadcasts its data to all other CPUs on the MPI subnet. This function is integrated in the CPU operating system.

Reduction ratio

The reduction ratio specifies the cyclic intervals for GD communication. You can set the reduction ratio when you configure global data communication in STEP 7. For example, if you set a reduction ratio of 7, global data are transferred only with every 7th cycle. This reduces CPU load.

Send and receive conditions

Conditions which should be satisfied for GD communication:

- For the transmitter of a GD packet:
 $\text{Reduction ratio}_{\text{transmitter}} \times \text{cycle time}_{\text{transmitter}} \geq 60 \text{ ms}$
- For the receiver of a GD packet:
 $\text{Reduction ratio}_{\text{receiver}} \times \text{cycle time}_{\text{receiver}} < \text{reduction ratio}_{\text{transmitter}} \times \text{cycle time}_{\text{transmitter}}$

A GD packet may be lost if you do not adhere to these conditions. The reasons being:

- the performance of the "smallest" CPU in the GD circuit
- asynchronous transmitting / receiving of global data at the stations

When setting in STEP 7: "Transmit after each CPU cycle", and the CPU has a short scan cycle time (< 60 ms), the operating system might overwrite a GD packet of the CPU before it is transmitted. The loss of global data is indicated in the status box of a GD circuit, if you set this function in your STEP 7 configuration.

GD resources of the CPUs

Table 3- 4 GD resources of the CPUs

Parameters	CPU 31xC, 312, 314	CPU 315-2 DP, 315-2 PN/DP, 317-2 DP, 317-2 PN/DP, 319-3 PN/DP
Number of GD circuits per CPU	Max. 4	Max. 8
GD packets transmitted per GD circuit	Max. 1	Max. 1
GD packets transmitted by all GD circuits	Max. 4	Max. 8
GD packets received per GD circuit	Max. 1	Max. 1
GD packets received by all GD circuits	Max. 4	Max. 8
Data length per GD packet	max. 22 bytes	max. 22 bytes
Consistency	max. 22 bytes	max. 22 bytes
Min. reduction ratio (default)	1 (8)	1 (8)

3.2.7 Routing

Properties

STEP 7 V5.1 + SP4 or higher allows you to access your S7 stations on all subnets with your PG/PC, for example, to

- download user programs
- download a hardware configuration, or
- perform debugging and diagnostic functions.

Note

When the CPU is used as an intelligent slave, the routing function is only available when the DP interface is set active. IN STEP 7, set the Test, Commission Routing check box on the properties dialog of the DP interface. For detailed information, refer to the *Programming with STEP 7* manual, or directly to the *STEP 7 Online Help*

Routing network nodes: MPI - DP

Gateways between subnets are routed in a SIMATIC station that is equipped with interfaces to the respective subnets. The figure below shows CPU 1 (DP master) acting as router for subnets 1 and 2.

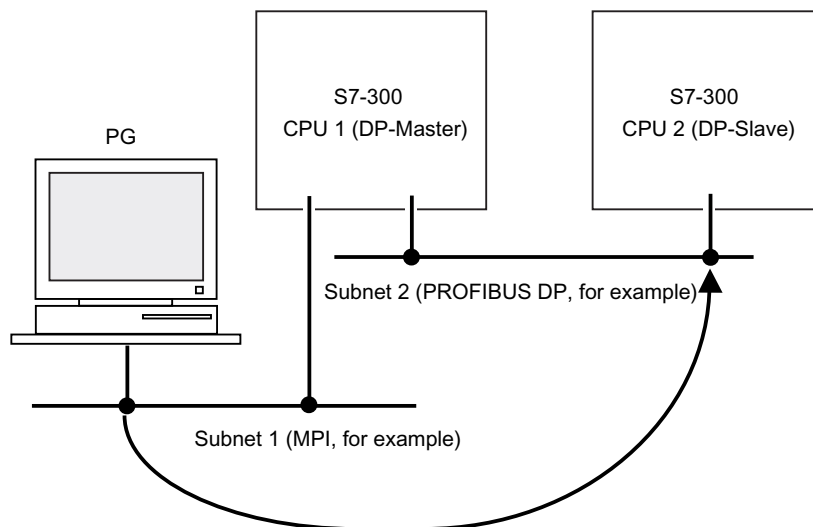

The figure below shows the MPI access to PROFINET via PROFIBUS CPU 1 (315-2 DP, for example) is the router for subnet 1 and 2; CPU 2 is the router for subnet 2 and 3.

Routing network nodes: MPI - DP - PROFINET

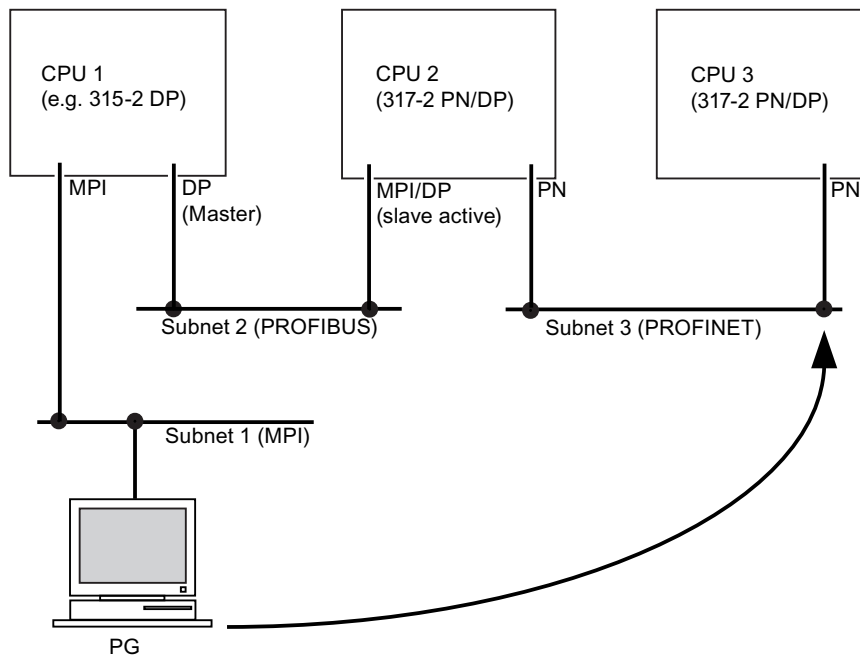

Number of connections for routing

The CPUs with DP interface provide a different number of connections for the routing function:

Table 3- 5 Number of routing connections for DP CPUs

CPU	As of firmware version	Number of connections for routing
31xC, CPU 31x	2.0.0	Max. 4
317-2 DP	2.1.0	Max. 8
31x-2 PN/DP	2.2.0	Interface X1 configured as: <ul style="list-style-type: none"> • MPI: Max. 10 • DP master Max. 24 • DP slave (active): Max. 14 Interface X2 configured as: <ul style="list-style-type: none"> • PROFINET: Max. 24
319-3 PN/DP	2.4.0	Interface X1 configured as: <ul style="list-style-type: none"> • MPI: Max. 10 • DP master Max. 24 • DP slave (active): Max. 14 Interface X2 configured as: <ul style="list-style-type: none"> • DP master Max. 24 • DP slave (active): Max. 14 Interface X3 configured as: <ul style="list-style-type: none"> • PROFINET: Max. 48

Requirements

- The station modules are "capable of routing" (CPUs or CPs).
- The network configuration does not exceed project limits.
- The modules have loaded the configuration data containing the latest "knowledge" of the entire network configuration of the project.

Reason: All modules participating in the network transition must receive the routing information defining the paths to other subnets.

- In your network configuration, the PG/PC you want to use to establish a connection via network node must be assigned to the network it is physically connected to.
- The CPU must set to master mode, or
- If the CPU is set to operate in slave mode, the Test, Commissioning, Routing functionality must be enabled by setting the check box in STEP 7, in the DP interface for DP slave properties dialog box.

Routing: Example of a TeleService application

The figure below shows the example of an application for remote maintenance of an S7 station using a PG. The connection to other subnets is here established via modem connection.

The lower section of the figure shows how to configure this in STEP 7.

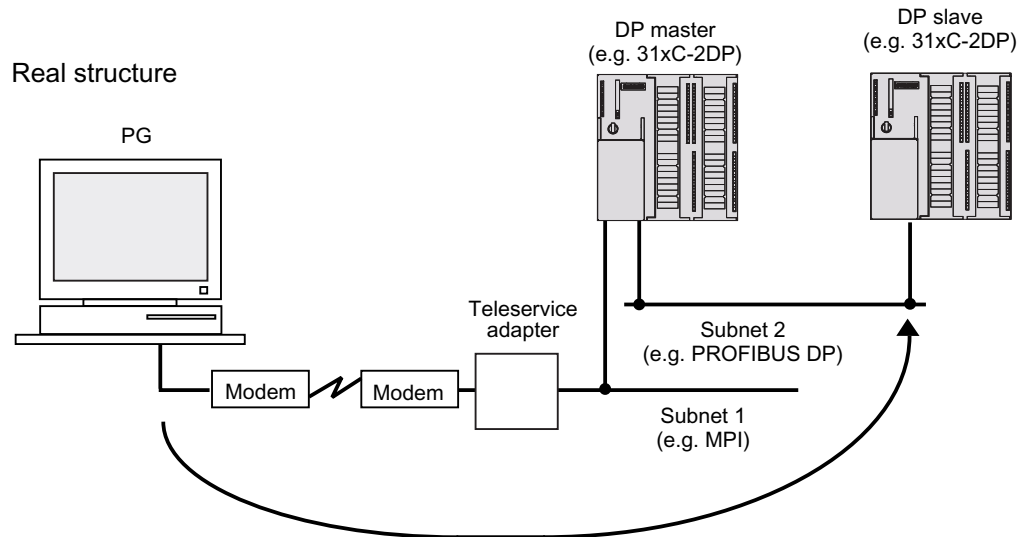

Configuration in STEP 7

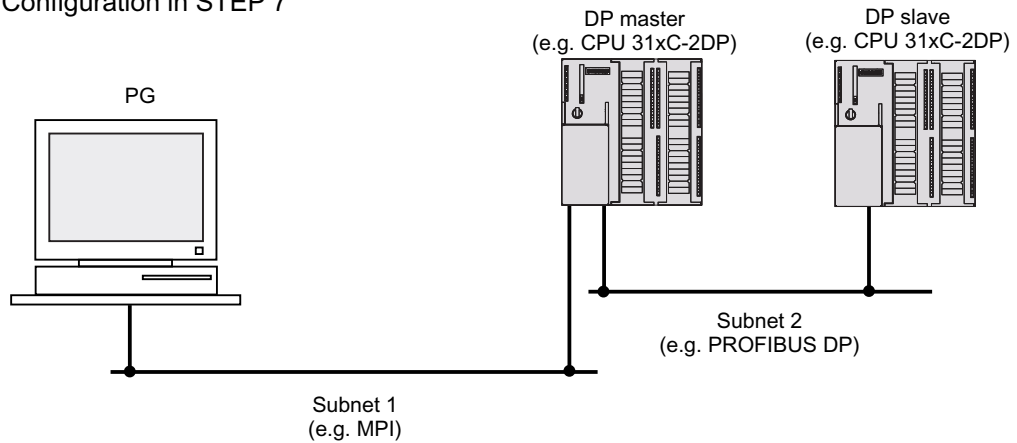

Reference

Further information

- on configuring in STEP 7 is found in the *Configuring Hardware and Connections in STEP 7* manual
- of a basic nature is contained in the *Communication with SIMATIC* Manual.
- on the TeleService adapter can be found on the Internet (<http://support.automation.siemens.com/WW/view/en/20983182>).
- on SFCs, refer to *Instruction list*.
For further information refer to *STEP 7 Online Help* or *System and Standard Functions* reference manual.
- on communication are found in the *Communication with SIMATIC* Manual.

3.2.8 Data set routing

Availability

The CPU 319-3 PN/DP V2.7 supports data set routing.

Routing and data set routing

Routing is the transfer of data beyond network boundaries. You can send information from a transmitter to a receiver across several networks.

Data set routing is an extension of "normal routing" and is used, for example, by SIMATIC PDM, when the programming device is not connected directly to the PROFIBUS DP subnetwork to which the target device is connected, but, for example, to the PROFINET interface of the CPU. The data sent through data record routing include the parameter assignments of the participating communication devices and device-specific information (for example, setpoint values, limit values, etc.). The structure of the target address for data record routing depends on the data contents, i.e. the slave to which the data are sent.

With the programming device, data set routing can also be used to read a parameter set already existing on the field device, edit it and return it to the field device when the programming device is assigned to a different subnetwork than that of the target slave.

The field devices themselves do not have to support data set routing, since they do not forward the information received.

See also

You can find additional information on *SIMATIC PDM* in *The Process Device Manager* Manual.

3.2.9 Point-to-point connection

Properties

PtP communication enables you to exchange data via serial port. PtP communication can be used to interconnect automation devices, computers or communication-capable systems of external suppliers. The function also allows adaptation to the protocol of the communication partner.

Reference

Further Information

- on SFCs are found in the *Instruction list*.
For detailed information, refer to the *STEP 7 Online Help* , or to the *System and Standard Functions Reference Manual*.
- on communication is found in the *Communication with SIMATIC Manual*.

3.2.10 Data consistency

Features

A data area is consistent if it can be read or written to from the operating system as a consistent block. Data exchanged collectively between the stations should belong together and originate from a single processing cycle, that is, be consistent. If the user program contains a programmed communication function, for example, access to shared data with X-SEND/ XRCV, access to that data area can be coordinated by means of the "BUSY" parameter itself.

With PUT/GET functions

For S7 communication functions, such as PUT/GET or write / read via OP communication, which do not require a block in the user program on the CPU (operating in server mode), allowances must be made in the program for the extent of the data consistency. The PUT/GET functions for S7 communication, or for reading/writing variables via OP communication, are executed at the CPU's scan cycle checkpoint. To save a defined process alarm response time, the communication variables are copied in blocks of up to 64 bytes (CPU 317, CPU 319: 160 bytes) to / from work memory at the scan cycle checkpoint of the operating system. Data consistency is not guaranteed for larger data areas.

Note

If a defined data deficiency is required, the defined communication variables in the user program of the CPU may be no larger than 64 bytes (for CPU 317, CPU 319: 160 bytes.)

3.2.11 Communication by means of PROFINET

What is PROFINET?

Within the framework of Totally Integrated Automation (TIA), PROFINET represents a consequent enhancement of:

- PROFIBUS DP, the established fieldbus and
- Industrial Ethernet, the communication bus for the cell level

Experience gained from both systems was and is being integrated into PROFINET.

PROFINET is an Ethernet-based automation standard of PROFIBUS International (previously PROFIBUS Users Organization e.V.), and defines a multi-vendor communication, automation, and engineering model.

Objectives in PROFINET

The objectives in PROFINET are:

- Open Ethernet Standard for automation based on Industrial Ethernet.
Although Industrial Ethernet and Standard Ethernet components can be used together, the Industrial Ethernet devices are more sturdy and therefore better suited for industrial environments (temperature, immunity to interference, etc.)
- Use of TCP/IP and IT standards
- Automation with real-time Ethernet
- Total integration of field bus systems

Implementing PROFINET in SIMATIC

We have integrated PROFINET as follows:

- Communication between field devices is implemented in SIMATIC by way of **PROFINET IO**.
- Communication between controllers which operate as components in distributed systems are implemented in SIMATIC by means of **PROFINET CBA** (Component Based Automation).
- Installation engineering and network components are available in SIMATIC NET.
- Established IT standards from the Office environment (e.g., SNMP=Simple Network Management Protocol for network parameter assignment and diagnosis) are used for remote maintenance and network diagnostics.

Documentation from PROFIBUS International on the Internet

The Internet (<http://www.profinet.com>) site of PROFIBUS International (previously PROFIBUS User Organization, PNO), contains numerous documents on the topic of PROFINET.

Further information can be found on the Internet (<http://www.siemens.com/profinet>).

What is PROFINET IO?

Within the framework of PROFINET, PROFINET IO is a communication concept for the implementation of modular, distributed applications.

PROFINET IO allows you to create automation solutions, which are familiar to you from PROFIBUS.

That is, you have the same application view in STEP 7, regardless of whether you configure PROFINET or PROFIBUS devices.

What is PROFINET CBA (Component Based Automation)?

Within the framework of PROFINET, PROFINET CBA is an automation concept for the implementation of applications with distributed intelligence.

PROFINET CBA lets you create distributed automation solutions, based on default components and partial solutions.

Component Based Automation allows you to use complete technological modules as standardized components in large systems.

The components are also created in an engineering tool which may differ from vendor to vendor. Components of SIMATIC devices are created, for example, with STEP 7.

Extent of PROFINET CBA and PROFINET IO

PROFINET IO and CBA represent two different views of automation devices on Industrial Ethernet.

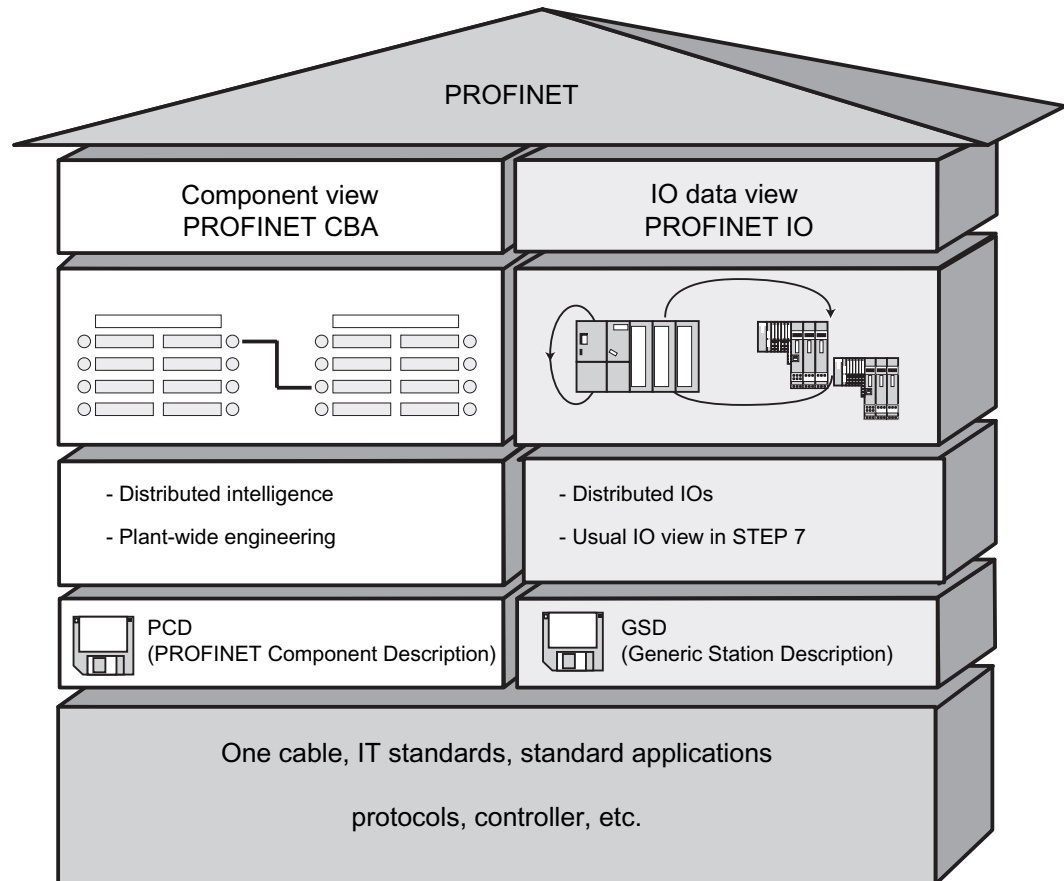

Figure 3-1 Extent of PROFINET IO and Component Based Automation

Component Based Automation divides the entire system into various functions. These functions are configured and programmed.

PROFINET IO provides you with a view of the system that is very similar to the view obtained in PROFIBUS. You continue to configure and program the individual automation devices.

Reference

Further Information

- on PROFINET IO and PROFINET CBA is available in the *PROFINET system specification*.
For differences and similarities between PROFIBUS DP and PROFINET IO, refer to the *From PROFIBUS DP to PROFINET IO* programming manual.
- For further information about PROFINET CBA, refer to the documentation on SIMATIC iMap and Component Based Automation.

3.2.11.1 PROFINET IO System

Functions of PROFINET IO

The following graphic shows the new functions in PROFINET IO:

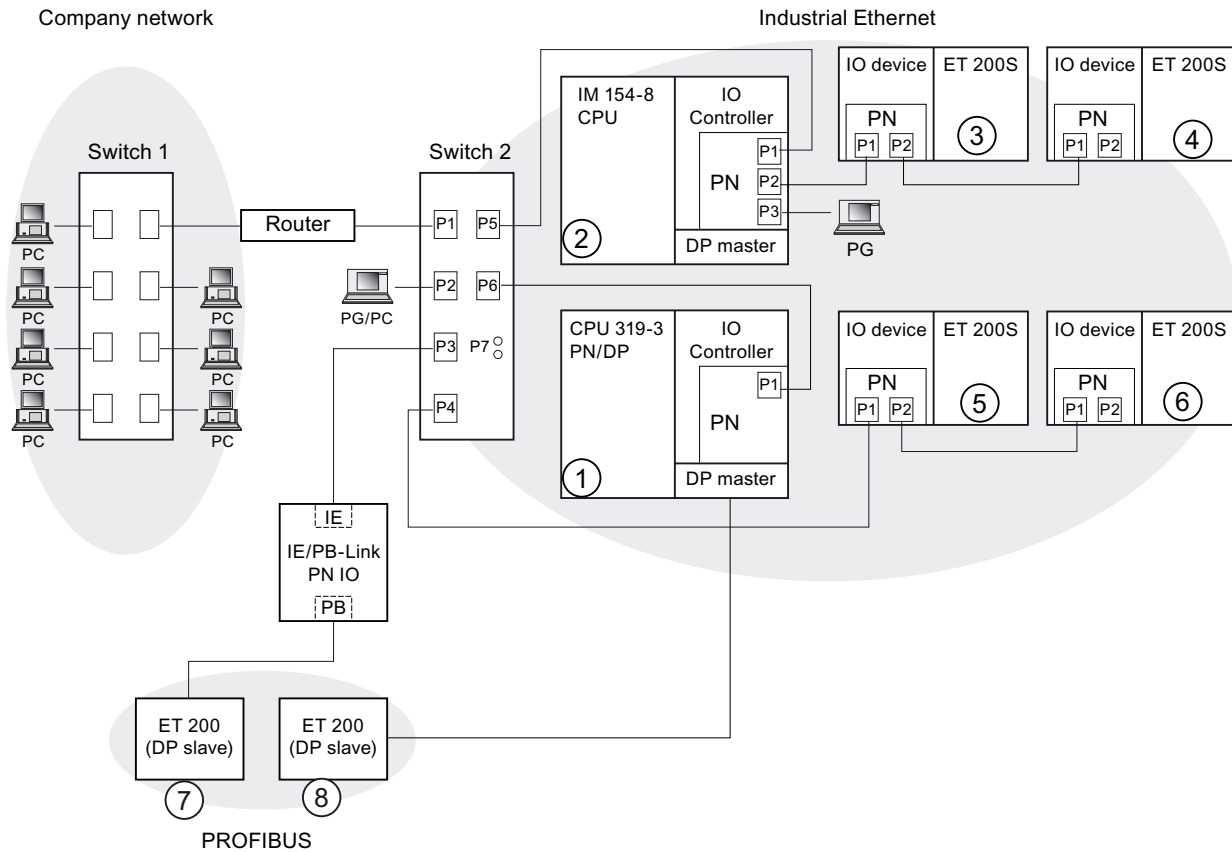

The graphic shows	Examples of connection paths
The connection of company network and field level	You can access devices at the field level from PCs in your company network Example: <ul style="list-style-type: none"> • PC - Switch 1 - Router - Switch 2 - CPU 319-3 PN/DP ①.
Connections between the automation system and field level	You can, of course, also access other areas on the Industrial Ethernet from a PG at the field level. Example: <ul style="list-style-type: none"> • PG - integrated switch IM 154-8 CPU ② - Switch 2 - integrated switch IO device ET 200S ③ - on IO device: ET 200S ⑥.

The graphic shows	Examples of connection paths
The IO controller of the CPU IM 154-8 CPU ② directly controls devices on the Industrial Ethernet and PROFIBUS.	<p>At this point, you can see the extended IO feature between the IO controller and IO device(s) on the Industrial Ethernet:</p> <ul style="list-style-type: none"> • The IM 154-8 CPU ② is operated as IO controller for the IO devices ET 200S ③ and ET 200S ④ • The IM 154-8 CPU ② is also the IO controller for ET 200 (DP slave) ⑦ by way of IE/PB Link.
The CPU 319-3 PN/DP ① can be operated as IO controller or DP master	<p>Here you can see that a CPU can be both the IO controller for an IO device and the DP master for a DP slave:</p> <ul style="list-style-type: none"> • The 319-3 PN/DP CPU ① is operated as IO controller for the IO devices ET 200S ⑤ and ET 200 S ⑥ • The CPU 319-3 PN/DP ① is the DP master for a DP slave ⑧. The DP slave ⑧ is assigned locally to the CPU ① and is not visible on the Industrial Ethernet.

Further information

You will find further information about PROFINET in the documents listed below:

- in the *System Description PROFINET*.
- In the *From PROFIBUS DP to PROFINET IO programming manual*.
This manual also provides a clear overview of the new PROFINET blocks and system status lists.

3.2.11.2 Blocks for PROFINET IO

Content of this section

This section covers:

- Blocks designed for use with PROFINET
- Blocks designed for use with PROFIBUS DP
- Blocks designed for use with PROFINET IO and PROFIBUS DP

Compatibility of the new blocks

New blocks were implemented for PROFINET IO, as PROFINET is capable of handling larger quantity frameworks. The new blocks are also used for PROFIBUS.

Comparison of the system and standard functions of PROFINET IO and PROFIBUS DP

For CPUs with integrated PROFINET interface, the table below provides an overview of:

- System and standard functions for SIMATIC which you will have to upgrade for migration from PROFIBUS DP to PROFINET IO.
- New system and standard functions

Table 3- 6 System and standard functions which are new or have to be replaced

Blocks	PROFINET IO	PROFIBUS DP
SFC12 (deactivation and activation of DP slaves/IO devices)	Yes CPU S7-300: FW V2.4 or higher:	Yes
SFC13 (reading diagnostics data from a DP slave)	No Replaced by: <ul style="list-style-type: none"> • Event-driven: SFB 54 • Status-driven: SFB 52 	Yes
SFC58/59 (write/read record in I/O)	No Replaced by: SFB 53/SFB 52	Yes already replaced by SFB53/52 in DPV1
SFB 52/53 (read/write record)	Yes	Yes
SFB 54 (evaluate interrupt)	Yes	Yes
SFC102 (read predefined parameters - S7-300 CPU only)	No Replaced by: SFB81	Yes for S7-300
SFB81 (read predefined parameters)	Yes	Yes
SFC5 (query start address of a module)	No (replaced with: SFC70)	Yes
SFC70 (query start address of a module)	Yes	Yes
SFC49 (query the slot at a logical address)	No Replaced by: SFC71	Yes
SFC71 (query the slot at a logical address)	Yes	Yes

The table below provides an overview of SIMATIC system and standard functions which must be emulated by other functions when migrating from PROFIBUS DP to PROFINET IO.

Table 3- 7 System and standard functions in PROFIBUS DP which can be emulated in PROFINET IO functions

Blocks	PROFINET IO	PROFIBUS DP
SFC55 (write dynamic parameters)	No Emulate using SFB53	Yes
SFC56 (write predefined parameters)	No Emulate using SFB81 and SFB53	Yes
SFC57 (assign module parameters)	No Emulate using SFB81 and SFB53	Yes

SIMATIC system and standard functions not supported in PROFINET IO:

- SFC7 (trigger hardware interrupt on DP master)
- SFC11 (synchronize groups of DP slaves)
- SFC72 (read data from communication partner within local S7 station)
- SFC73 (write data to communication partner within local S7 station)
- SFC74 (cancel communication with partner within local S7 station)
- SFC103 (determine the bus topology in a DP master system)

Comparison of the organization blocks of PROFINET IO and PROFIBUS DP

The table below shows the changes to OB83 and OB86 in PROFINET IO compared to PROFIBUS DP.

Table 3- 8 OBs in PROFINET IO and PROFIBUS DP

Blocks	PROFINET IO	PROFIBUS DP
OB83 (hot swapping of modules/submodules)	Also supported on S7-300, new error information	S7-300 does not support this function Slaves integrated via the GSD file report the removal/insertion of modules/submodules during operation in the form of a diagnostics interrupt and thus via OB82. S7 slaves report a station failure and call OB86 when an insertion/removal interrupt is generated.
OB86 (rack failure)	New error information	Unchanged

Detailed information

For detailed information about the blocks, refer to the *System Software for S7-300/400 System and Standard Functions* Reference Manual.

3.2.11.3 Open communication via Industrial Ethernet

Requirements

- STEP 7 as of V5.4 + SP4

Functionality

The CPUs with integrated PROFINET interface as of firmware V2.3.0 or V2.4.0 support the functionality of open communication by means of Industrial Ethernet (abbreviated: *open IE communication*)

Following services are available for open IE communication:

- Connection oriented protocols
 - TCP according to RFC 793, connection type B#16#01, firmware V2.3.0 and higher
 - TCP according to RFC 793, connection type B#16#11, firmware V2.4.0 and higher
 - ISO on TCP according to RFC 1006, as of firmware V2.4.0
- Connectionless protocols
 - UDP according to RFC 768, as of firmware V2.4.0

Features of the communication protocols

The following distinctions are made between protocol types in data communication:

- Connection oriented protocols:

Prior to data transmission these establish a (logical) connection to the communication partner and close this again, if necessary, after transmission is completed. Connection oriented protocols are used when security is especially important in data transmission. A physical cable can generally accommodate several logical connections.

For the FBs to open communication by means of Industrial Ethernet, the following connection oriented protocols are supported:

- TCP according to RFC 793 (connection types B#16#01 and B#16#11)
- ISO on TCP according to RFC 1006 (connection type B#16#12)

- Connectionless protocols:

These operate without a connection. There is also no establishing or terminating a connection to remote partner. Connectionless protocols transmit data to the remote partner without any acknowledgement; data transfer is, therefore, not secure.

The FBs for open communication over Industrial Ethernet support the following connectionless protocol:

- UDP according to RFC 768 (connection type B#16#13)

How to use open IE communication

To allow data to be exchanged with other communication partners, STEP 7 provides the following FBs and UDTs under "Communication Blocks" in the "Standard Library":

- Connection oriented protocols: TCP, ISO-on-TCP
 - FB 63 "TSEND" for sending data
 - FB 64 "TRCV" for receiving data
 - FB 65 "TCON", for connecting
 - FB 66 "TDISCON", for disconnecting
 - UDT 65 "TCON_PAR" with the data structure for the configuration of the connection
- Connectionless protocol: UDP
 - FB 67 "TUSEND" for sending data
 - FB 68 "TURCV" for receiving data
 - FB 65 "TCON" for establishing the local communication access point
 - FB 66 "TDISCON" for resolving the local communication access point
 - UDT 65 "TCON_PAR" with the data structure for configuring the local communication access point
 - UDT 66 "TCON_ADR" with the data structure of the address parameters of the remote partner

Data blocks for the configuration of the connection

- Data blocks for configuring TCP and ISO-on-TCP connections.

To configure your connection, you need to create a DB that contains the data structure of UDT 65 "TCON_PAR." This data structure contains all parameters you need to establish the connection. You need to create such a data structure for each connection, and you can also organize it in a global DB.

The CONNECT parameter of the FB65 "TCON" contains a reference to the address of the corresponding connection description (for example, P#DB100.DBX0.0, byte 64).
- Data blocks for the configuration the local UDP communication access point

To assign parameters for the local communication access point, create a DB containing the data structure from the UDT 65 "TCON_PAR" This data structure contains the required parameters you need to establish the connection between the user program and the communication level of the operating system

The CONNECT parameter of the FB 65 "TCON" contains a reference to the address of the corresponding connection description (e.g., P#DB100.DBX0.0 Byte 64).

Note

Setting up the connection description (UDT 65)

Declare the communication interface at the "local_device_id" parameter in UDT65 "TCON_PAR". Example, B#16#03: communication via integrated IE interface of CPU 319-3 PN/DP.

Establishing a connection for communication

- Use with TCP and ISO on TCP

Both communication partners call FB 65 "TCON" to establish the connection. In your connection configuration, you define which communication partner activates the connection, and which communication partner responds to the request with a passive connection. To determine the number of possible connections, refer to your CPU's technical specifications.

The CPU automatically monitors and holds the active connection.

If the connection is broken, for example by line interruption or by the remote communication partner, the active partner tries to reestablish the connection. You do not have to call FB 65 "TCON" again.

FB 66 "TDISCON" disconnects the CPU from a communication partner, as does STOP mode. To reestablish the connection to have to call FB65 "TCON" again.

- Use with UDP

Both communication partners call FB 65 "TCON" to set up their local communication access point. This establishes a connection between the user program and operating system's communication level. No connection is established to the remote partner.

The local access point is used to send and receive UDP telegrams.

Disconnecting

- Use with TCP and ISO on TCP

FB 66 "TDISCON" disconnects the communication connection between CPU and communication partner.

- Use with UDP

FB 66 "TDISCON" disconnects the local communication access point, i.e., the connection between user program and communication level of operating system is interrupted.

Options for interrupting the communication connection

Events causing interruptions of communication:

- You program the cancellation of connections at FB 66 "TDISCON."
- The CPU goes from RUN to STOP.
- At POWER OFF / POWER ON

Reference

For detailed information on the blocks described earlier, refer to the *STEP 7 Online Help*.

3.2.11.4 SNMP Communication Service

Availability

The SNMP V1, MIB-II communication service is available for CPUs with integrated PROFINET interface and Firmware 2.2 or higher.

Properties

SNMP (Simple Network Management Protocol) is a standard protocol for TCP/IP networks.

Reference

For further information on the SNMP communication service and diagnostics with SNMP, refer to the *PROFINET Operating Instructions* and to the *S7-300 CPU 31xC and CPU 31x, Hardware Installation Manual*.

3.3 Web server

Introduction

The web server allows you to monitor your CPU on the Internet or on the Intranet of your company. This functionality supports remote analysis and diagnostics.

Messages and status information are visualized on HTML pages.

Web browser

You need a web browser to access the HTML pages of the CPU.

Web browsers which are suitable for communication with the CPU:

- Internet Explorer (version 6.0 and higher)
- Mozilla Firefox (V1.5 and higher)
- Opera (version 9.0 and higher)
- Netscape Navigator (version 8.1 and higher)

Reading information via the web server

The web server can be used to read the following information from the CPU:

- Start page with general CPU information
- Identification information
- Content of the diagnostic buffer
- Messages (without acknowledgment option)
- Information on PROFINET
- Variable status
- Variable tables

For the CPU 319 PN/DP V2.7 furthermore:

- Module state
- Topology

The next pages describe the HTML pages and corresponding declarations in detail.

Web access to the CPU via programming device/PC

Proceed as follows to access the web server:

1. Connect the client (PG/PC) to the CPU via the PROFINET interface.
2. Open the Web browser.

Enter the IP address of the CPU in the "Address" field of the web browser in the format `http://a.b.c.d` (example: `http://192.168.3.141`).

The start page of the CPU opens. From the start page you can navigate to further information.

Web access to the CPU by way of HMI devices and PDA

The web server supports the Windows Terminal Service. In addition to operations with PGs and PCs, this functionality also supports the integration of thin client solutions for mobile devices (PDA, MOBIC T8, for example) and of rugged local stations (SIMATIC MP370 with ThinClient/MP option, for example) on a Windows CE platform.

Proceed as follows to access the web server:

1. Interconnect the client (HMI, PDA) with the CPU via PROFINET interface.
2. Open the Web browser.

Enter the IP address of the CPU in the "Address" field of the web browser in the format `http://a.b.c.d/basic` (example: `http://192.168.3.141/basic`).

The start page of the CPU opens. From the start page you can navigate to further information.

HMIs operating with Windows CE operating system V 5.x or earlier process CPU information in a browser specially developed for Windows CE. The information appears in a simplified format in this browser. The following figures show the detailed format respectively.

Note

Web server without SIMATIC Micro Memory Card

You can also use the web server without SIMATIC Micro Memory Card. The CPU must have been assigned an IP address for server operation.

- The content of the diagnostic buffer is displayed in hexadecimal code.
 - Star page, identification and PROFINET information and variable status are displayed as plain text.
 - The content of the topology information shows only the CPU with a red margin, since there is no configuration for the SIMATIC Micro Memory Card.
 - The displays of the messages and of the module information remain empty.
-

Security

The web server by itself does not provide any security. Protect your web-compliant CPUs against unauthorized access by means of a firewall.

3.3.1 Language settings

Introduction

The Web server provides information and diagnostic information in the following languages:

- German (Germany)
- English (United States)
- French (France)
- Italian (Italy)
- Spanish (traditional)
- Simplified Chinese
- Japanese

The two Asian languages can be combined as follows:

- Chinese with English
- Japanese with English

Requirements for the availability of the Asian languages

The following requirements have to be fulfilled for the Asian languages Chinese and Japanese:

- Windows XP with the corresponding language package is installed on the display device (for example PC).
- STEP 7 for Asian languages (V5.4 + SP 4) is installed on the programming device used to configure the CPU.

Requirements for multilingual output of text

Language settings to be made in STEP 7 in order to ensure proper output of data in the selected language:

- Set the regional language for the display devices in SIMATIC Manager
- Set the regional Web language in the properties dialog of the CPU. For further information refer to the chapter "Settings in HW Config, "Web" tab".Settings in HW Config, "Web" tab (Page 68)

Set the regional language for the display devices in SIMATIC Manager

Select the regional language for the display devices in SIMATIC Manager:
Options > Language for display devices

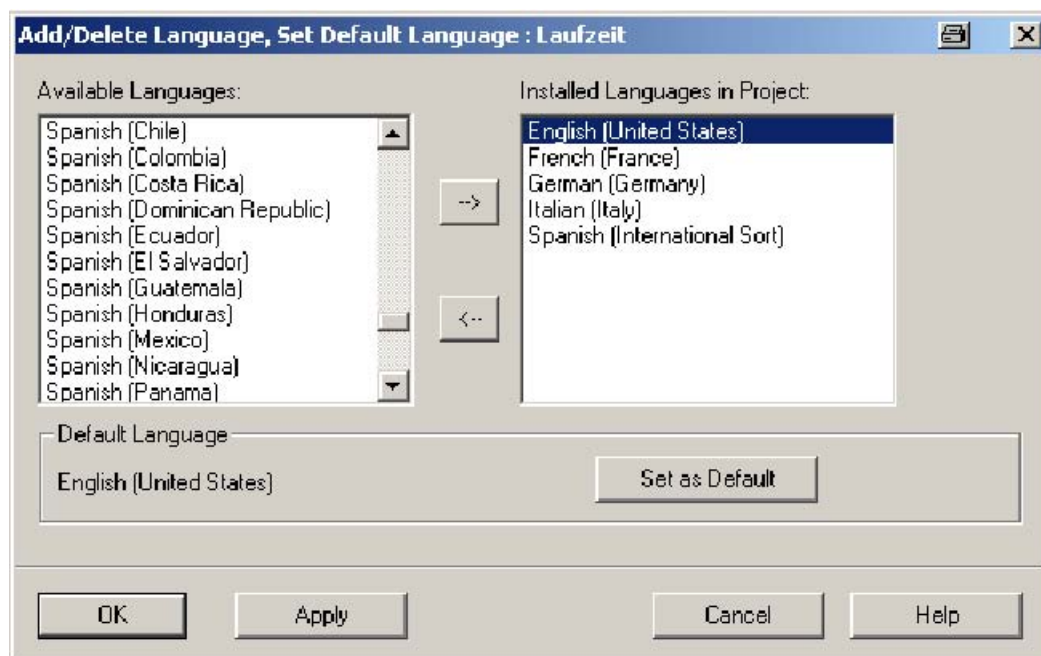

Figure 3-2 Example of the selection of a language for display devices

3.3.2 Settings in HW Config, "Web" tab

Requirements

You have opened the property view of the CPU in HW Config.

Carry out the following settings in the "Web" tab to use the full functionality of the Web server:

- Activating the Web server
- Set the regional web language
- Activating automatic updating
- Selecting the display classes of the messages

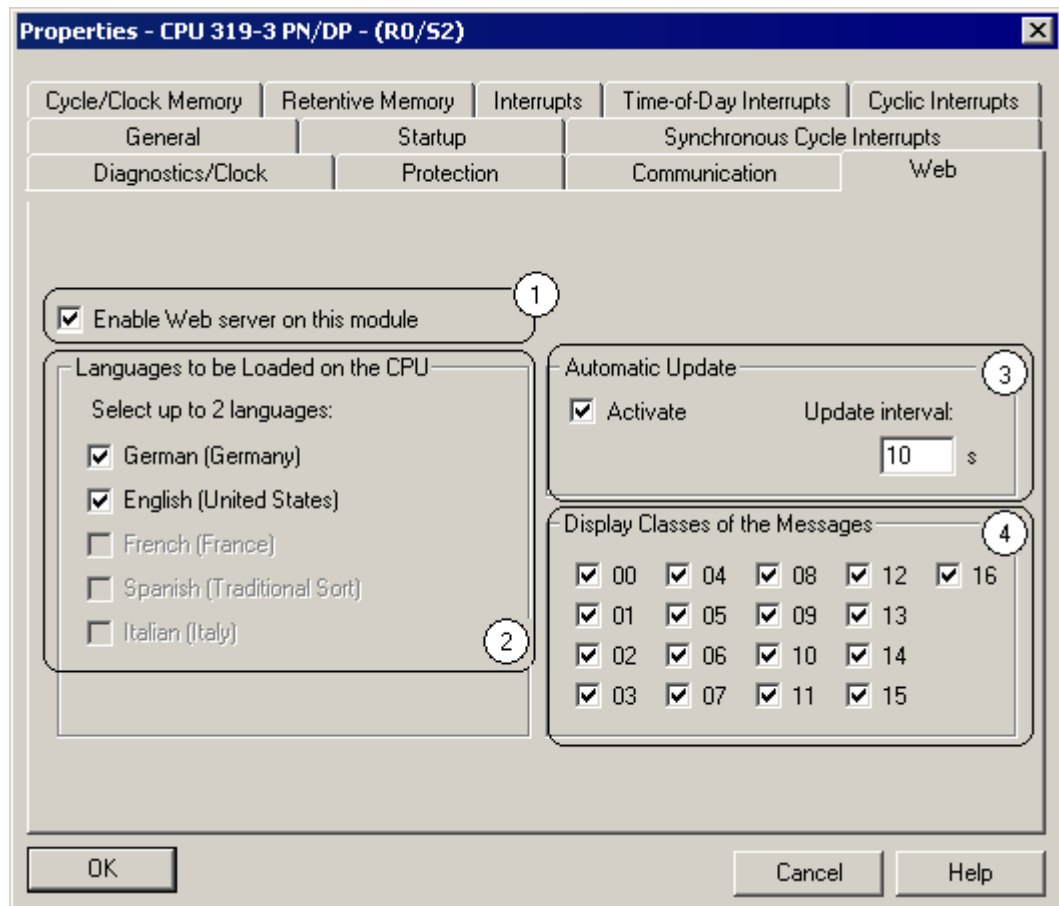

① Activating the Web server

The Web server is deactivated in the basic configuration in HW Config. You activate the Web server in HW Config.

In the property view of the CPU:

- Activate the "Activate Web server on this module" check box

② Setting the language for Web

Select up to two web languages from the languages installed for the display devices.

In the property view of the CPU:

- Activate the "Activate Web server on this module" check box
- Select up to two web languages.

Note

The program displays messages and diagnostics information in hexadecimal code if you activate a web server without selecting a language.

③ Activating automatic updating

The following Web pages can be updated automatically:

- Start page
- Module state
- Information about the PROFINET
- Variable status
- Tag table

In the property view of the CPU:

- Activate the "Activate Web server on this module" check box
- Activate the "Activate" check box under "Automatic update"
- Enter the updating interval

Note

Update time

The updating interval set in HW Config is the shortest update time. Larger amounts of data or several HTTP connections increase the update time.

④ Display classes of the messages

All the display classes of the messages are activated in the basic configuration in HW Config. The messages for the selected display classes are displayed later on the "Messages" Web page. The messages for the display classes that are not selected are shown as hexadecimal code and not as plain text.

How to configure the message classes:

- For "Report system error" in HW Config under **Options > Report system error**
- For module-specific messages in STEP 7

For information about configuring message texts and classes please refer to STEP 7.

Note

Reducing the memory requirements of the Web SDBs

You can reduce the memory requirements of the Web SDBs by selecting only those display classes of the messages that are to be filled in the Web SDB.

3.3.3 Updating

Update status of the screen content

The automatic updating is deactivated in the basic configuration in HW Config. This means that the Web server screen display supplies static information.

You update the Web pages manually using either the icon  or the function key <F5>.

Update status of printouts

The printed information may be more up-to-date than the screen display.

To obtain a print preview of the Web page, click the  button.

Filter settings have no effect on the printout, The printout of the "Messages" and "Module information" Web pages always shows the complete content of the pages.

Deactivating automatic updating for an original Web page

Select the icon  **Off** to deactivate the automatic updating for a Web page briefly.

The  **Active** icon or the function key <F5> is used to activate automatic updating again.

3.3.4 Web pages

3.3.4.1 Start page with general CPU information

Going online to the web server

You log on to the Web server by entering the IP address of the configured CPU in the address bar of the Web browser, for example: `http://192.168.1.158`. The connection opens with the "Intro" page.

Introduction

During the first start the Web server calls up the following page:



Figure 3-3 Intro

Click the ENTER link to go to the web server pages.

Note

Skipping the intro

Activate the "Skip Intro" check box in order to access the start page of the Web server. To display the intro at the start of the Web server again, click the "Intro" link on the start page.

Start page

The start page returns information as shown in the picture below.

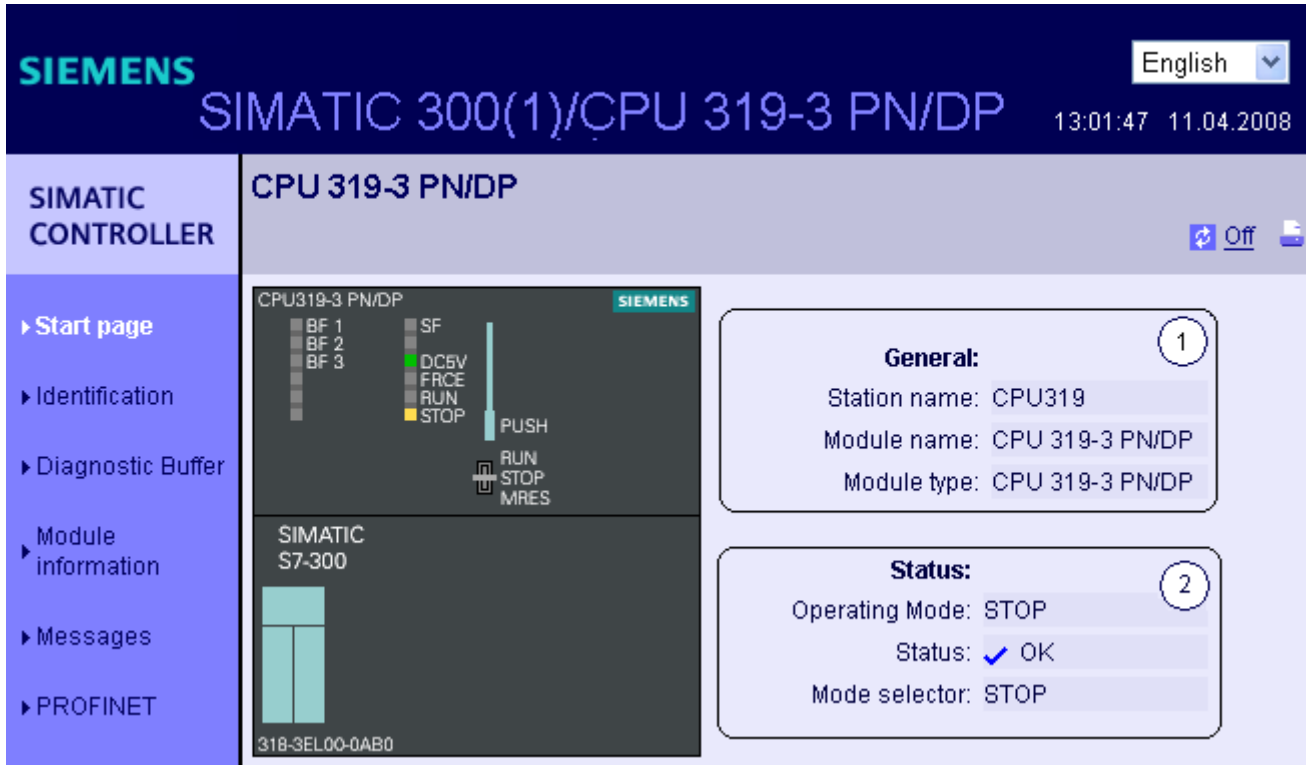

Figure 3-4 General Information

The CPU image with LEDs returns the actual CPU status at the time of data request.

① "General"

"General" contains information about the CPU with whose Web server you are currently connected.

② "Status"

"Status" contains information about the CPU at the moment of the query.

3.3.4.2 Identification

Technical data

The identification web page returns technical data of the CPU.

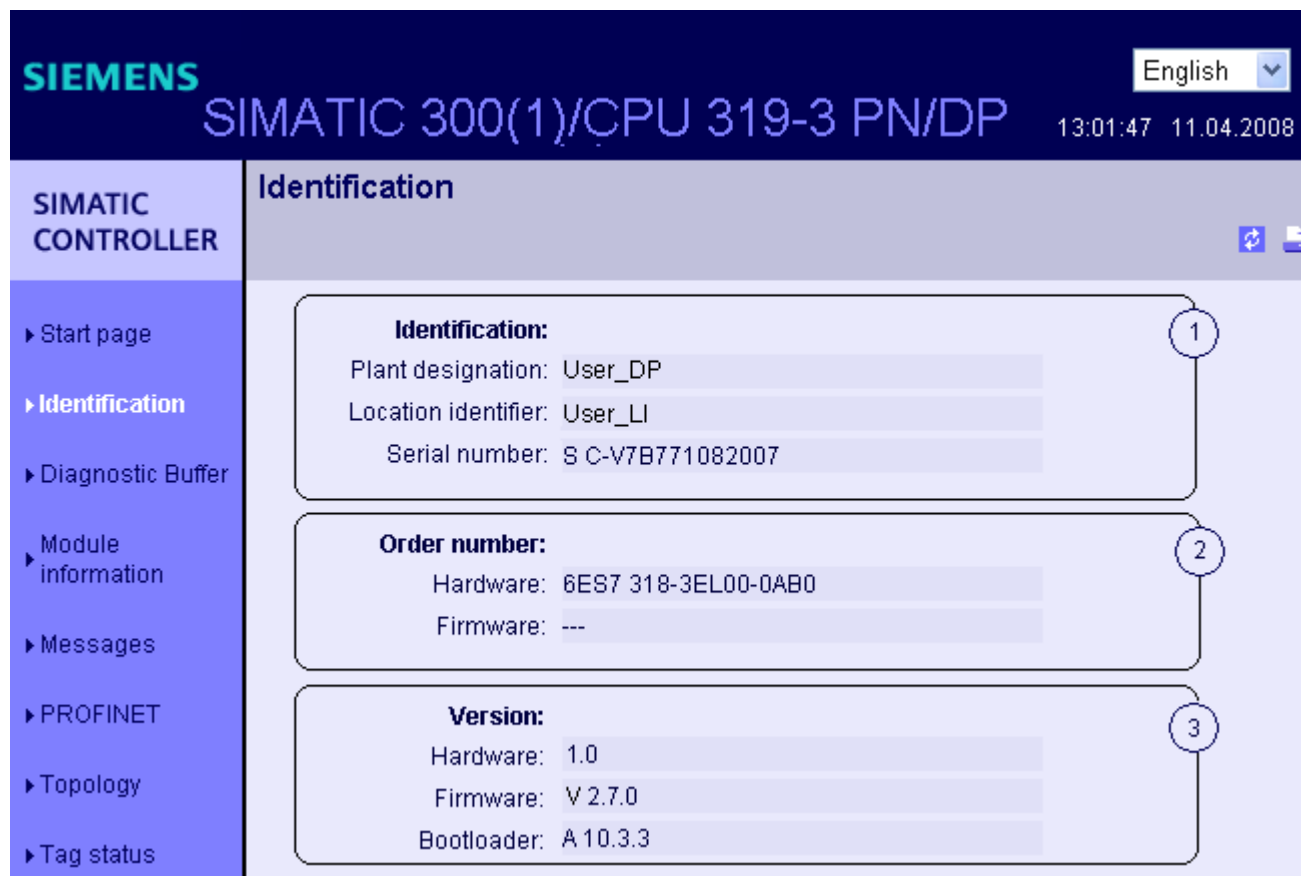

Figure 3-5 Identification

① "Identification"

The "Identification" info box contains the higher item and location designations and the serial number. Higher item and location designations can be configured in the HW Config in the properties dialog of the CPU, "General" tab.

② "Order number"

The "Order number" info box contains order numbers for the hardware and firmware (if it exists).

③ "Version"

You can find the hardware, firmware and bootloader versions in the "Version" field.

3.3.4.3 Diagnostics buffer

Diagnostics buffer

The browser displays the content of the diagnostics buffer on the "Diagnostics buffer" Web page.

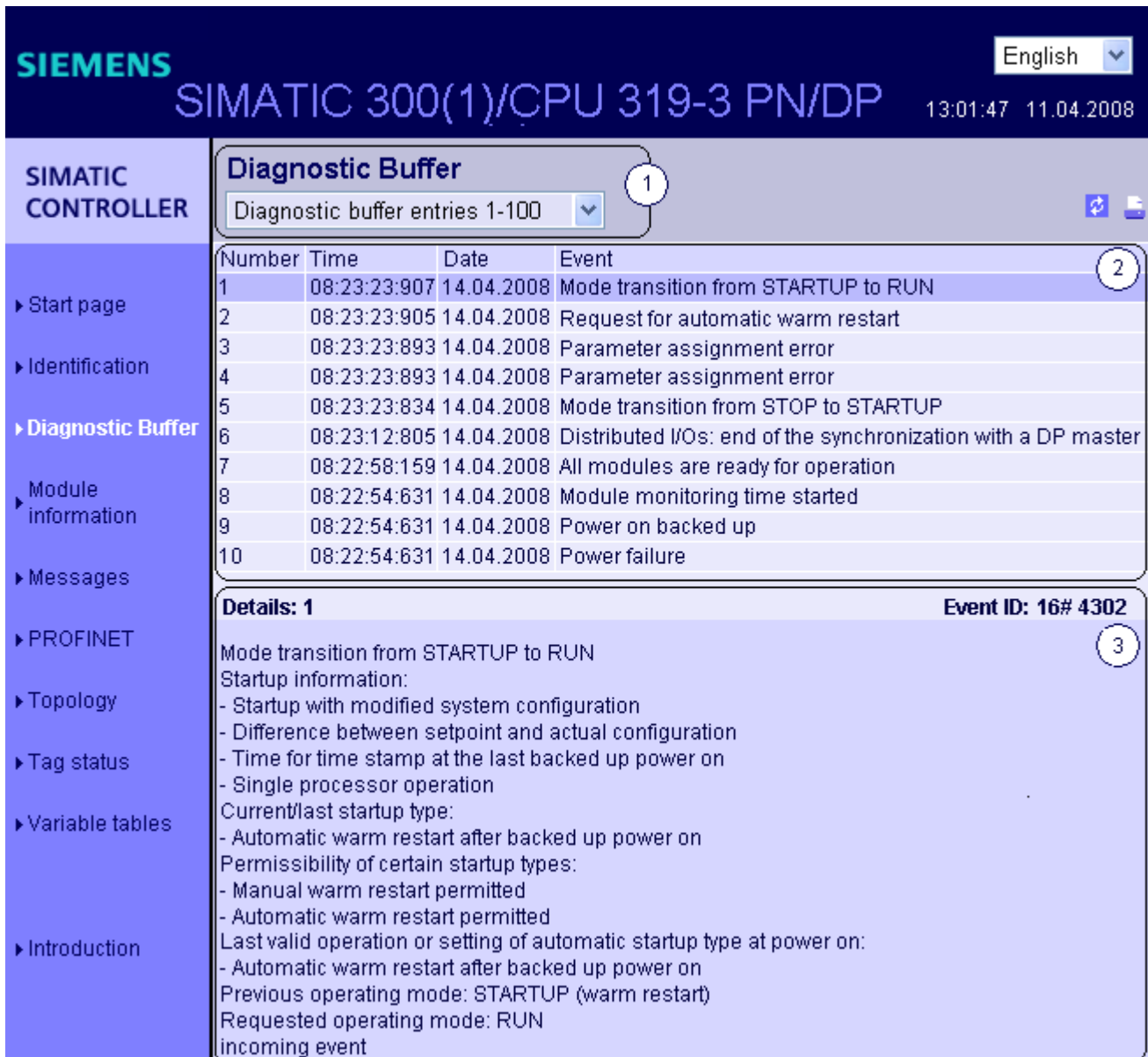

Figure 3-6 Diagnostics buffer

Requirements

The web server is activated, languages are set, and the project is compiled and downloaded in STEP 7.

① "Diagnostics buffer entries 1 to 100"

The diagnostics buffer can save up to 500 messages. Select an interval for the entries from the drop-down list box. Each interval comprises 100 entries each.

The program only displays the last 10 buffer entries in RUN for reasons of performance.

② "Event"

The "Event" info box contains the diagnostic events with the date and time.

③ "Details"

This field outputs detailed information about a selected event.

Select the corresponding event from the ②"Event" info field.

Configuration

Configuration procedure:

1. Open the "Object properties" dialog box from the shortcut menu of the corresponding CPU.
2. Select the "Web" tab, and then activate the "Activate web server on this module" check box.
3. Select up to two languages to be used to display plain text messages.
4. Save and compile the project and download the configuration data to the CPU.

Special features when changing languages

You can change the language, for example, from German to English, by clicking the object in the upper right corner. If you select a language you have not configured the program returns a hexadecimal code instead of plain text information.

3.3.4.4 Module state

Requirements

- You have carried out the following settings in HW Config:
 - Web server activated,
 - Language settings carried out,
 - "Report system error" generated and activated.
- You have compiled the project using STEP 7 HW Config, loaded the SDB container and the user program (in particular the user program blocks generated by "Report system error").
- The CPU is in RUN mode.

Note

"Report system error"

- **Duration of the display:** Depending on the plant extension level, the "Report system error" display requires some time to create the initial evaluation of the state of all the configured IO modules and IO systems. During this time there is no concrete display of the status of the "Module information" Web page. A "?" is displayed in the "Error" column.
 - **Dynamic response:** "Report system error" has to be called up cyclically at least every 100 ms.
The callup can take place in the OB 1, or if the cycle time amounts to more than 100 ms, in the watchdog interrupt OB 3x (≤ 100 ms) and in the startup OB 100.
-

Module state

The state of a station is displayed with symbols and comments on the "Module information" Web page.

The screenshot shows the SIMATIC Web server interface for a CPU319. The main content area is titled 'Module information' and displays a table with the following data:

Error	Name	Comment
✓	MyUR	Comment on bus system RACK (CPU)
✓	PROFIBUS(1): DP-Mastersystem (1)	Comment on master system DP
✓	Ethernet(1): PROFINET-IO-System (100)	Comment on master system PNIO

Figure 3-7 Module state - station

Meaning of the symbols

Symbol	Color	Meaning
✓	Green	Component OK
?	Black	Component cannot be accessed / State cannot be determined The "State cannot be determined" is, for example, always displayed in the STOP state of the CPU or during the initial evaluation of "Report system error" for all the configured IO modules and IO systems after the CPU has been restarted. However, this state can also be displayed temporarily during operation if a diagnostic interrupt wave occurs at all the modules.
🔧	Green	Maintenance required
🔧	Yellow	Maintenance demanded
🔧	Red	Error - component failed or faulty
✓	-	Error in a lower module level

Navigation to further module levels

The state of individual componentry / modules / submodules is displayed when you navigate to the further module levels:

- To higher module levels using the links in the display of the module levels②
- To lower module levels using the links in the "Name" column

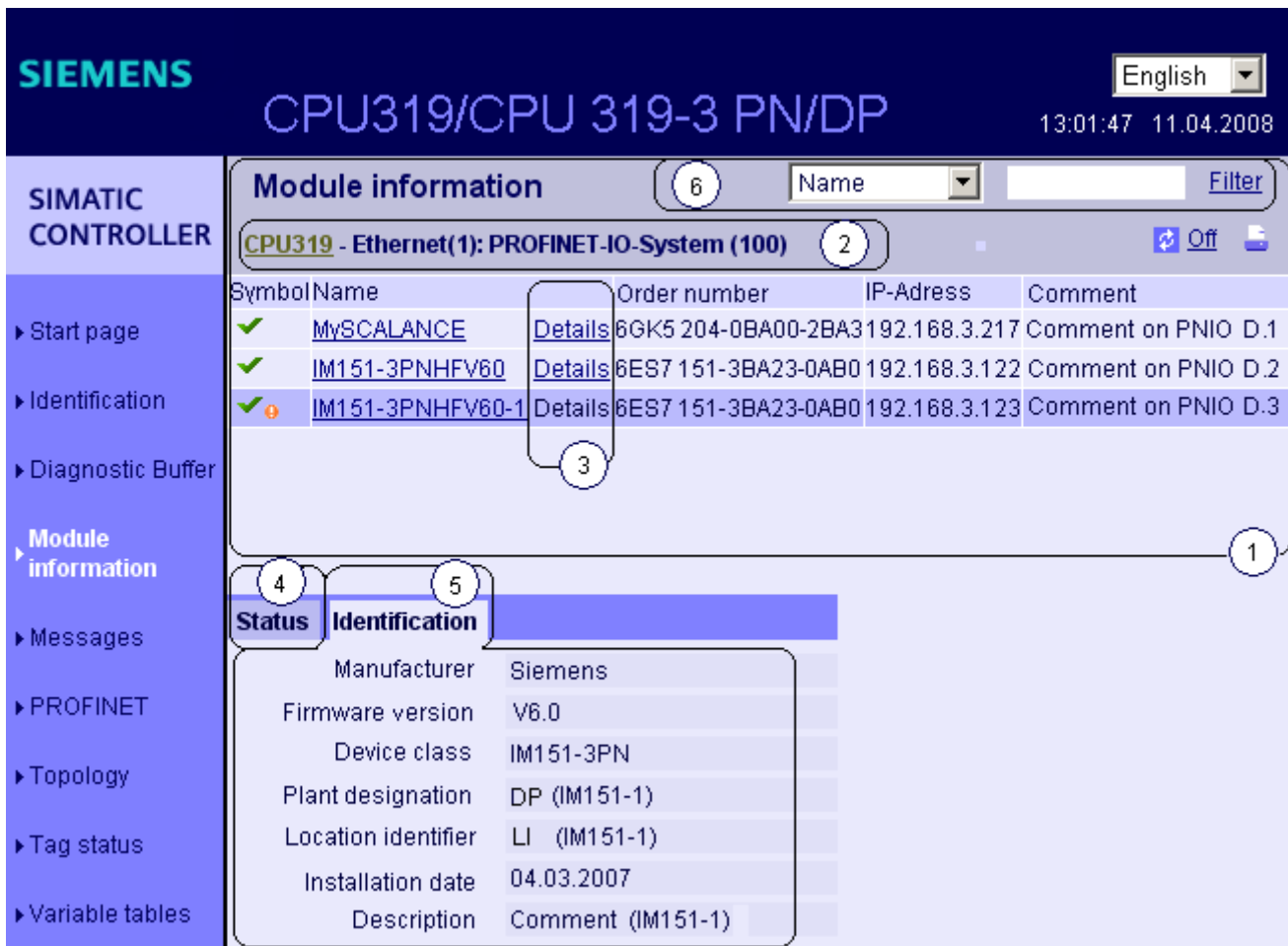

Figure 3-8 Module state - module

① "Module information"

Depending on the selected level, the table contains information about the rack, the DP master system, the PNIO master system, about the nodes, the individual modules or also the equipment or submodules of the station.

② "Display of the module levels"

The links are used to access the "Module information" of the higher module levels.

③ "Details"

Further information about the selected module is provided in the "Status" and "Identification" tabs by using the "Details" link.

④ "Status" tab

The tab contains information about the status of the selected module when a fault or message exists.

⑤ "Identification" tab

The tab contains data on the identification of the selected module.

Note

This tab displays only data configured offline (no online data of modules).

⑥ "Filter"

You can search in the table using specific criteria:

1. Select a parameter from the drop-down list box.
2. If appropriate, enter the value of the selected parameter.
3. Click "Filter".

The filter criteria are also retained when you update a page.

To deactivate the filter settings click "Filter" again.

Example: Module state - module

The screenshot shows the SIMATIC Web server interface for a CPU319 system. The main content area displays the following table of modules:

Slot	Symbol Name	Order number	I Addr.	O Addr.	Comment
0	✓ IM151-3PNHFV60-1 Details	6ES7 151-3BA23-0AB0			
1	✓ PM-E DC24V Details	6ES7 138-4CA01-0AA0	8171		...Modul PM-E (3)
2	✓ 4DI DC24V HF Details	6ES7 131-4BD01-0AB0	1.0		...Modul 4DI (3)
3	✗ 2DO DC24V/0,5A HF Details	6ES7 132-4BB01-0AB0		1.0	...Modul 2DO (3)

Below the table, the **Status** tab is active, displaying the following message:

PN device 3 on PN system 100 Slot: 3: Module removed Name: IM151-3PNHFV60-1 Module: 2DO DC24V/0,5A HF I/O address: 01

Figure 3-9 Module state - module

Example: Module state - submodule

The screenshot shows the SIMATIC Web server interface for a CPU319. The main content area displays 'Module information' for 'CPU319-Ethernet(1): PROFINET-...-IM151-3PNHFV60-1 - IM151-3PNHFV60-1'. A table lists the module details:

Slot	Symbol Name	Order number	I Addr.	O Addr.	Comment
X1	✓ MyIM151-3PN (3) Details	6ES7 151-3BA23-0AB0	8172		...bus system PNIO
X1 P1	✓ MyPort 1 (3) Details	6ES7 151-3BA23-0AB0	8175		...PNIO-Port 1 (3)
X1 P2	✓ MyPort 2 (3) Details	6ES7 151-3BA23-0AB0	8174		...PNIO-Port 2 (3)

Below the table, there are tabs for 'Status' and 'Identification'. The left navigation menu includes options like 'Start page', 'Identification', 'Diagnostic Buffer', 'Module information', 'Messages', 'PROFINET', and 'Topology'.

Figure 3-10 Module state - submodule

Reference

For further information about the "Module information" and about the topic "Configuring 'Signaling system faults'" refer to the *STEP 7 Online Help*.

3.3.4.5 Messages

Requirements

The message texts were configured in the user-specific languages. For information about configuring message texts please refer to STEP 7 and to the Service&Service pages (<http://support.automation.siemens.com/WW/view/en/23872245>).

Messages

The browser displays the content of the message buffer on the "Messages" Web page. The alarms cannot be acknowledged on the web server.

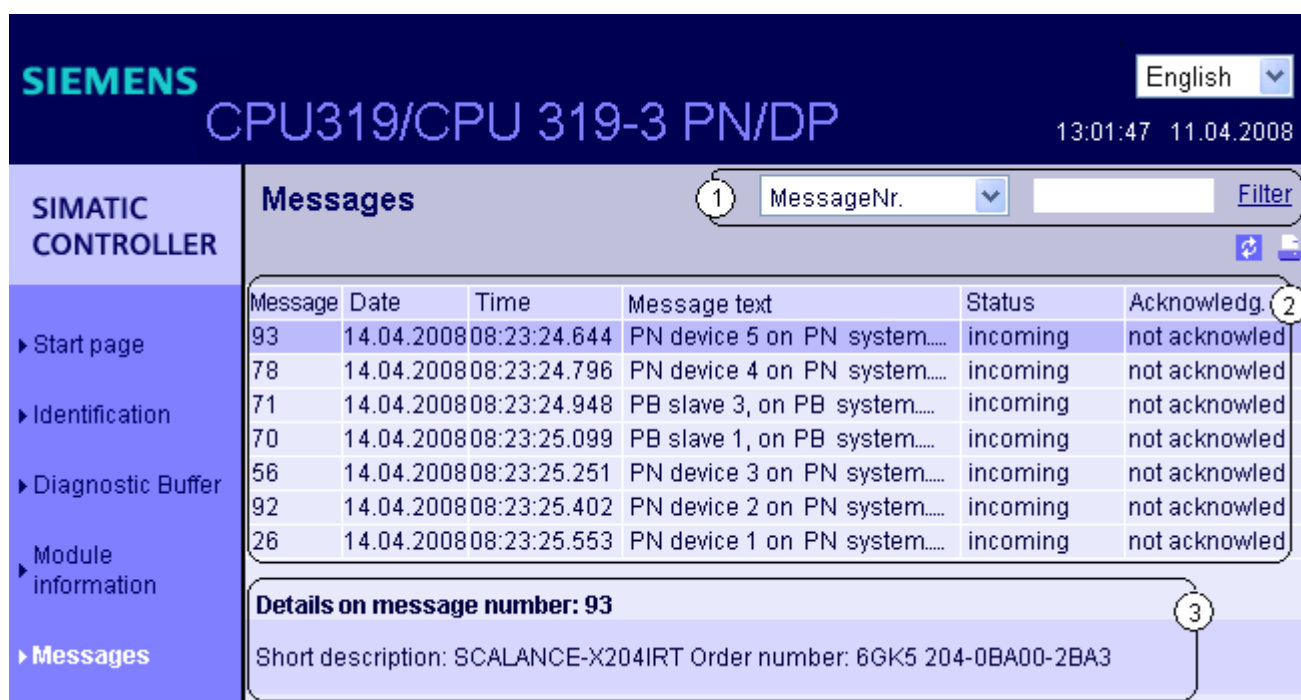

Figure 3-11 Alarms

① "Filter"

You can search in the table using specific criteria.

1. Select a parameter from the drop-down list box.
2. If appropriate, enter the value of the selected parameter.
3. Click "Filter".

The filter criteria are also retained when you update a page.

To deactivate the filter settings click "Filter" again.

Effects

- The filter settings are also retained when you update a page.
- Filter settings have no effect on the print-out, which always contains the entire content of the message buffer.

② "Alarms"

Alarms of the CPU are displayed in the info field ② in chronological order, including the **date** and **time**.

The **message text** parameter is an entry which contains the message texts configured for the corresponding fault definitions.

Sorting

You can also view the parameters in ascending or descending order. Click in the column header of one of the parameters.

- Message number
- Date
- Time
- Message Text
- State
- Acknowledgment

The messages are returned in chronological order when you click the "Date" entry. Incoming and outgoing events are output at the **Status** parameter.

③ "Message number details"

You can view detailed message information in this info field. Select the corresponding message from the info field ② .

Special features when changing languages

You can change the language, for example, from German to English, by clicking the object in the upper right corner. If you select a language or corresponding message texts you have not configured the program returns a hexadecimal code instead of plain text information.

3.3.4.6 PROFINET

PROFINET

The "Parameters" tab ① of this web page contain a summary of information about the integrated PROFINET interface of the CPU.

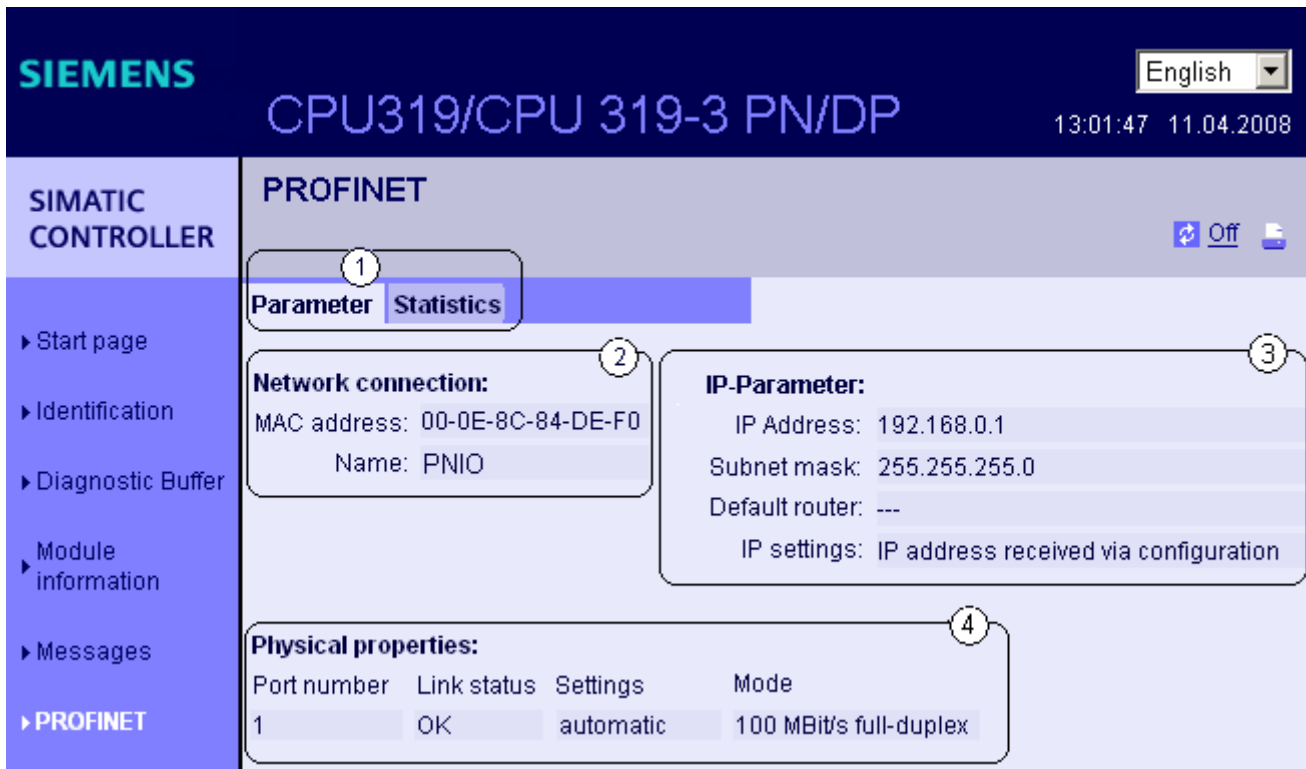

Figure 3-12 Parameters of the integrated PROFINET interface

② "Network connection"

This page returns information for the identification of the integrated PROFINET interface of the corresponding CPU.

③ "IP parameters"

Information about the configured IP address and number of the subnet in which the corresponding CPU is networked.

④ "Physical properties"

Information available in the "Physical properties" info field:

- Port number
- Link status
- Settings
- Mode

Information about the quality of data transfers is available in the ① "Statistics" tab.

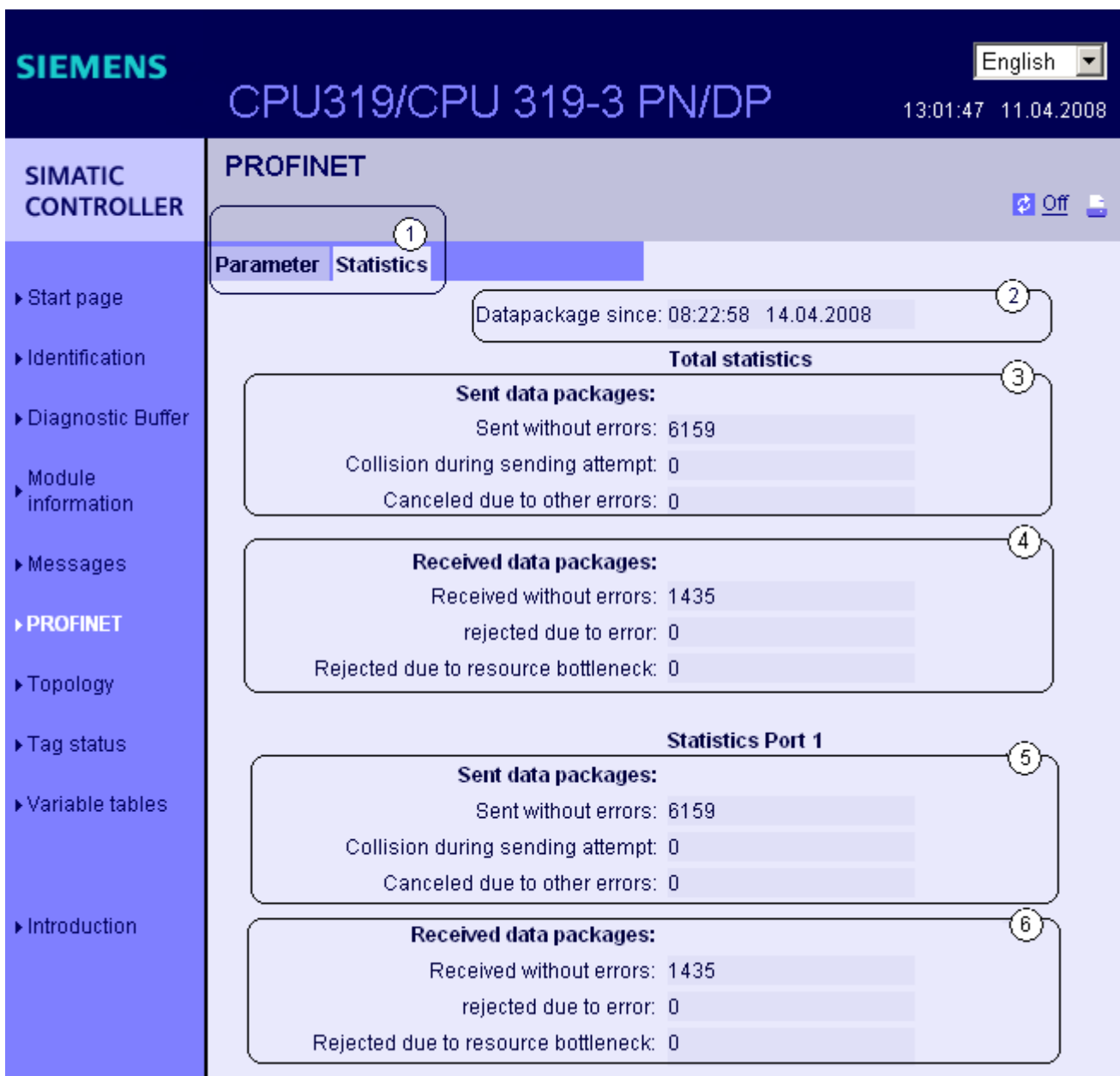

Figure 3-13 Data transfer identifiers

② "Data packets since"

This shows the time at which the first data packet was sent or received after the last Power on/memory reset.

③ "Overall statistics - Sent data packets"

You can evaluate the quality of data transmission on the send line based on the identifiers returned in this info field.

④ "Overall statistics - Data packets received"

You can evaluate the quality of data transmission on the receiving line based on the identifiers returned in this info field.

⑤ "Statistics Port 1 - Sent data packets"

The quality of the data transmission on the transmission line can be determined from the key figures in this info box.

⑥ "Statistics Port 1 - Data packets received"

The quality of the data transmission on the reception line can be determined from the key figures in this info box.

3.3.4.7 Topology

Topology of the PROFINET nodes

The "Topology" Web page shows the configured PROFINET nodes of a station as well as the unconfigured nodes that are nevertheless accessible through neighbor recognition in a graphical and table view.

Both views can be printed out. Before printing, use the print preview of your browser and, if necessary, correct the format.

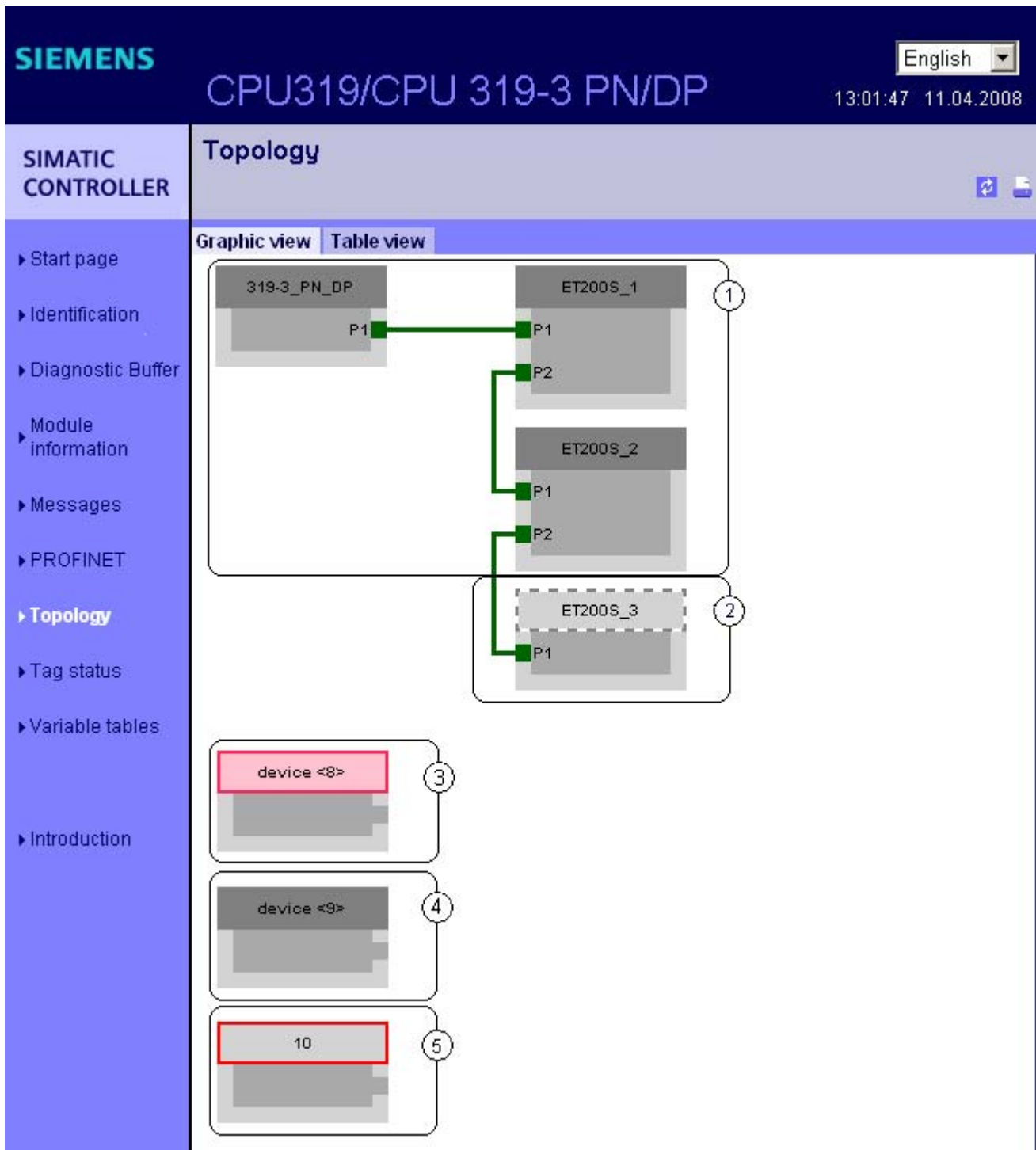

Figure 3-14 Topology - graphical view

Requirements

The Web server is activated, languages are set, and the project is compiled and downloaded in HW Config.

① Configured and accessible PROFINET nodes

Configured and accessible PROFINET nodes are displayed in dark gray. Green connections show through which ports the PROFINET nodes of a station are connected.

② Unconfigured and accessible PROFINET devices

PROFINET devices that are not configured but can be accessed directly ("neighboring stations") are displayed in light gray and with a dashed line.

③ Configured but inaccessible PROFINET nodes

The configured but inaccessible PROFINET nodes are displayed in the lower section in pink and with a red frame and device number.

④ Configured node without neighbor relationships

Nodes for which no neighbor relationship can be determined are displayed in dark gray and only with the device number:

- IE/PB links and the PROFIBUS nodes connected to them
- PROFINET devices that do not support LLDP (neighbor recognition)

The PROFINET nodes can be identified in HW Config through the device numbers.

⑤ Displaying faulty neighbor relationships

The nodes whose neighbor relationships are incomplete or can only be read out with an error are displayed in light gray with a red frame.

Note

Displaying faulty neighbor relationships

A firmware update of the affected component is required.

Topology - table view

SIMATIC CONTROLLER		Topology			
		Graphic view	Table view		
		Port		Partner port	
▶ Start page		319-3_PN_DP			
▶ Identification			port-001	ET200S_1	port-001
▶ Diagnostic Buffer		ET200S_1			
			port-001	319-3_PN_DP	port-001
			port-002	ET200S_2	port-001
▶ Module information		ET200S_2			
			port-001	ET200S_1	port-002
			port-002	ET200S_3	port-001
▶ Messages		ET200S_3			
			port-001	ET200S_2	port-002
▶ PROFINET		8			
▶ Topology		9			
▶ Tag status		10			

Figure 3-15 Topology - table view

Meaning of symbols

Symbol	Meaning
	Configured and accessible PROFINET nodes
	Unconfigured and accessible PROFINET nodes
	Configured but inaccessible PROFINET nodes
	Nodes for which neighbor relations cannot be determined or for which the neighbor relationship could not be read out completely or only with errors

3.3.4.8 Variable status

Variable status

The browser outputs the variable status on the web page of the same name. You can monitor the status of up to 50 variables.

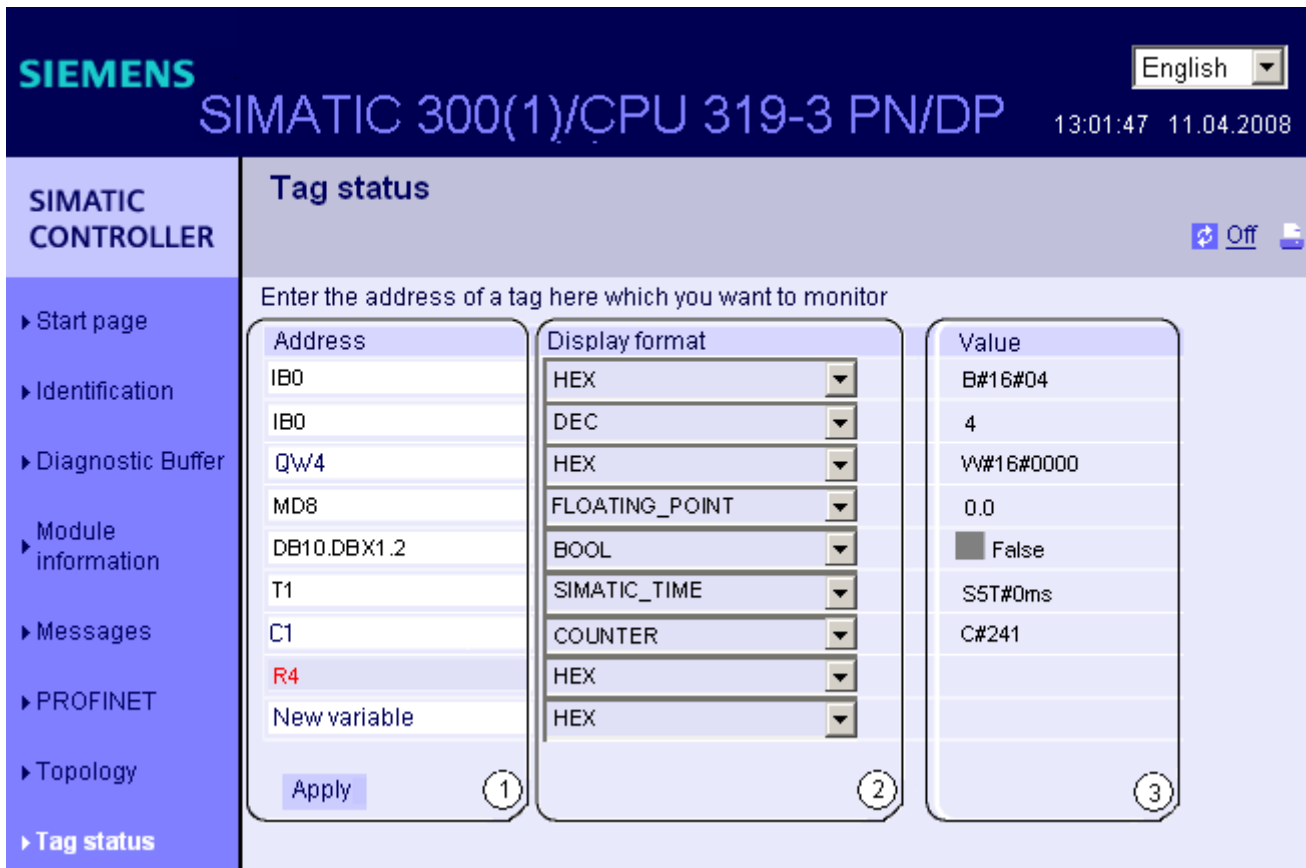

Figure 3-16 Variable status

① "Address"

Enter the address of the operand of which you want to monitor the response in the "Address" text box. Invalid addresses entered are displayed in red font.

② "Display format"

Select the display format of a variable using the drop-down list. The program indicates the variable in hex code if it does not support the selected display format.

③ "Value"

Outputs the value of the corresponding operand in the selected format.

Special features when changing languages

You can change the language, for example, from German to English, by clicking the object in the upper right corner. The German mnemonics differ compared to other languages. The syntax of operands you enter may be invalid for this reason when you change languages. For example, ABxy instead of QBxy. The browser outputs a faulty syntax in red font.

3.3.4.9 Variable tables

Variable tables

The browser returns the content of the variable tables on the web page of the same name. You can monitor up to 200 variables in each variable table.

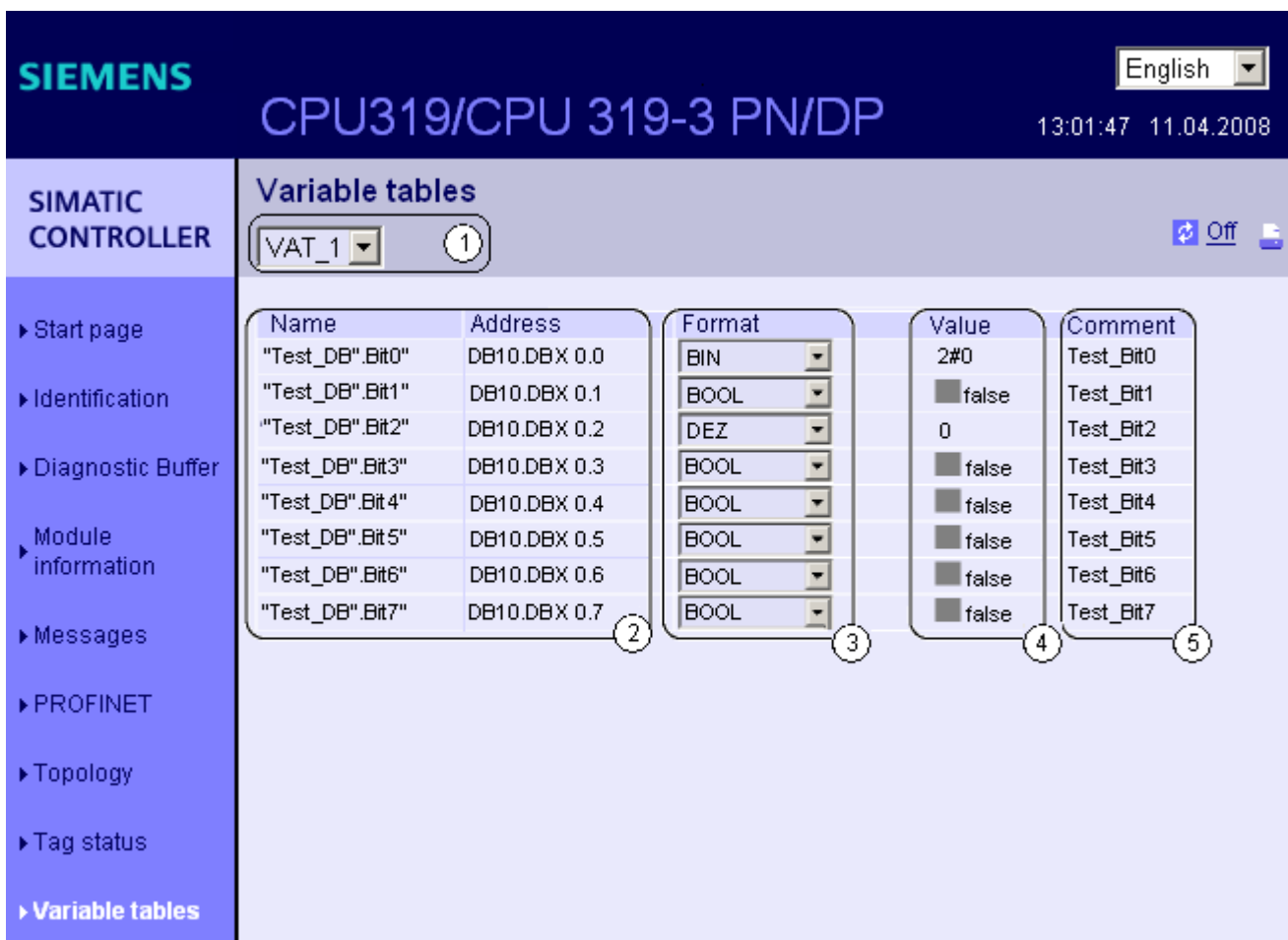

Figure 3-17 Variable tables

① **Selection**

Select one of the configured variable tables from this drop-down list box.

② **"Name" and "Address"**

This info field returns the operand's name and address.

③ **"Format"**

Select the display format of the corresponding operand using the drop-down list boxes. The drop-down list box outputs a selection of all valid display formats.

④ **"Value"**

This column shows the values in the corresponding display format.

⑤ **"Comment"**

The program outputs the comment you configured in order to highlight the meaning of an operand.

Configuring variable tables for the web server

The web server lets you monitor up to 50 variable tables with maximum 200 variables. As CPU memory is shared by messages and variables, the actually available number of variable tables may be reduced.

Example: There is sufficient memory space for 400 configured messages and 50 variable tables with 100 variables (including the symbol names, however, without symbol comment).

The web browser only outputs partial variable tables if memory capacity is exceeded due to the number of configured messages and variables. You counteract this negative effect by reducing memory requirements for your messages and system comments. You should also use only one language to display information.

You should also configure your variable tables with as few variables as possible, with short names and comments, in order to ensure that the variable tables are displayed in full by the Web server and will also be updated faster than tables containing a large number of variables (limited memory of the CPU).

Creating a variable table for the web server

1. Generate a variable table in STEP 7.
2. Open the properties dialog of the variable table and select the "General - Part 2" tab.
3. Activate the "Web server" check box.

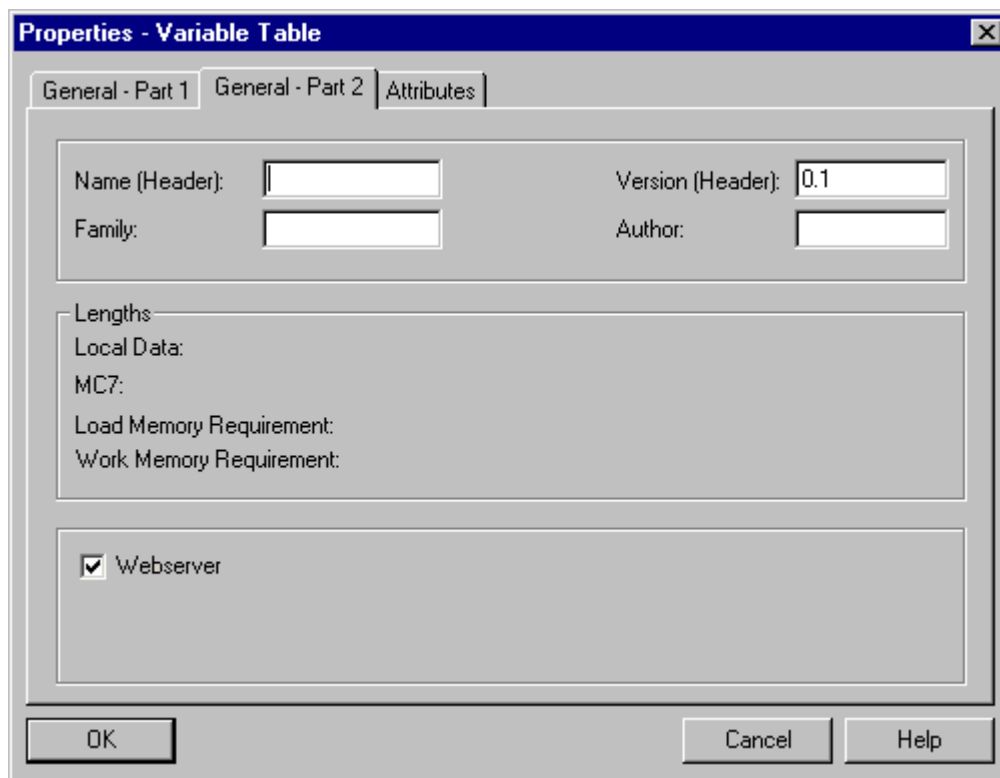

4. Save and compile the project and download the configuration data to the CPU.

3.4 S7 connections

3.4.1 S7 connection as communication path

An S7 connection is established when S7 modules communicate with one another. This S7 connection is the communication path.

Note

S7 connections are not required for global data communication, point-to-point connection, communication by way of PROFIBUS DP, PROFINET CBA, PROFINET IO, TCP/IP, ISO on TCP, UDP, SNMP and web server.

Every communication link requires S7 connection resources on the CPU for the entire duration of this connection.

Each S7 CPU provides a specific number of S7 connection resources which are used by various communication services such as PG/OP communication, S7 communication or S7 basic communication.

Connection points

An S7 connection between modules with communication capability is established between connection points. The S7 connection always has two connection points: The active and passive connection points:

- The active connection point is assigned to the module that establishes the S7 connection.
- The passive connection point is assigned to the module that accepts the S7 connection.

Any module that is capable of communication can thus act as an S7 connection point. The active communication always occupies one S7 connection at the the connection point on the relevant module.

Transition point

If you use the routing functionality, the S7 connection between two modules capable of communication is established across a number of subnets. These subnets are interconnected via a network transition. The module that implements this network transition is known as a router. The router is thus the point through which an S7 connection passes.

Any CPU with a DP or PN interface can be the router for an S7 connection. You can establish a specific number of routing connections. This does not limit the quantity framework of S7 connections.

See also

Connection resources for routing (Page 99)

3.4.2 Assignment of S7 connections

There are several ways to allocate S7 connections on a communication-capable module:

- Reservation during configuration
- Assigning connections in the program
- Allocating connections during commissioning, testing and diagnostics routines
- Allocating connection resources to HMI services

Reservation during configuration

One connection resource each is automatically reserved on the CPU for PG and OP communication. Whenever you need more connection resources (for example, when connecting several OPs), configure this increase in the CPU properties dialog box in STEP 7.

Connections must also be configured (using NetPro) for the use of S7 communication. For this purpose, connection resources have to be available, which are not allocated to PG/OP or other connections. The required S7 connections are then permanently allocated for S7 communication when the configuration is downloaded to the CPU.

Assigning connections in the program

In S7 basic communication, and in open Industrial Ethernet communication with TCP/IP, the user program establishes the connection. The CPU operating system initiates the connection. S7 basic communication uses the corresponding S7 connections. The open IE communication does not use any S7 connections. However, a maximum number of connections also applies to this type of communication:

- 8 connections at the CPUs 31x-2 PN/DP and
- 32 connections at the CPU 319-3 PN/DP

Using connections for commissioning, testing and diagnostics

An active online function on the engineering station (programming device/PC with STEP 7) occupies S7 connections for programming device communication:

- An S7 connection resource for PG communication which was reserved in your CPU hardware configuration is assigned to the engineering station, that is, it only needs to be allocated.
- If all reserved S7 connection resources for PG communication are allocated, the operating system automatically assigns a free S7 connection resource which has not yet been reserved. If no more connection resources are available, the engineering station cannot go online to the CPU.

Allocating connection resources to HMI services

An online function on the HMI station (OP/TP/... with *WinCC*) is used for assigning S7 connection resources for the OP communication:

- An S7 connection resource for OP communication you have reserved in your CPU hardware configuration is therefore assigned to the OCM station engineering station, that is, it only needs to be allocated.
- If all reserved S7 connection resources for OP communication are allocated, the operating system automatically assigns a free S7 connection resource which has not yet been reserved. If no more connection resources are available, the OCM station cannot go online to the CPU.

Time sequence for allocation of S7 connection resources

When you program your project in STEP 7, the system generates parameter assignment blocks which are read by the modules in the startup phase. This allows the module's operating system to reserve or allocate the relevant S7 connection resources. That is, for instance, OPs cannot access a reserved S7 connection resource for PG communication. The CPU's S7 connection resources which were not reserved can be used freely. These S7 connection resources are allocated in the order they are requested.

Example

If there is only one free S7 connection left on the CPU, you can still connect a PG to the bus. The PG can then communicate with the CPU. The S7 connection is only used, however, when the PG is communicating with the CPU. If you connect an OP to the bus while the PG is not communicating, the OP can establish a connection to the CPU. Since an OP maintains its communication link at all times, in contrast to the PG, you cannot subsequently establish another connection via the PG.

See also

Open communication via Industrial Ethernet (Page 60)

3.4.3 Distribution and availability of S7 connection resources

Distribution of connection resources

Table 3-9 Distribution of connections

Communication service	Distribution
PG communication OP communication S7 basic communication	In order to avoid allocation of connection resources being dependent only on the chronological sequence in which various communication services are requested, connection resources can be reserved for these services. For PG and OP communication respectively, at least one connection resource is reserved by default. In the table below, and in the technical data of the CPUs, you can find the configurable S7 connection resources and the default configuration for each CPU. You "redistribute" connection resources by setting the relevant CPU parameters in STEP 7.
S7 communication Other communication resources (e.g. via CP 343-1, with a data length of > 240 bytes)	Available connection resources that are not specially reserved for a service (PG/OP communication , S7 basis communication) are used for this.
Routing PG functions (only for CPUs with DP/PN interface)	The CPUs provide a certain number of connection resources for routing. These connections are available in addition to the connection resources. The subsection below shows the number of connection resources.
Global data communication Point-to-point connection	This communication service requires no S7 connection resources.
PROFIBUS DP	This communication service requires no S7 connection resources.
PROFINET CBA	This communication service requires no S7 connection resources.
PROFINET IO	This communication service requires no S7 connection resources.
Web server	This communication service requires no S7 connection resources.
Open communication by means of TCP/IP	This communication service requires no S7 connection resources.
Open communication by means of ISO on TCP	Independently of the S7 connections, a total of 8 own resources are available for connections or local access points (UDP) for TCP/IP, ISO on TCP, UDP.
Open communication by means of UDP	
SNMP	This communication service requires no S7 connection resources.

Availability of connection resources

Table 3- 10 Availability of connection resources

CPU	Total number connection resources	Reserved for			Free S7 connections
		PG communication	OP communication	S7 basic communication	
312C	6	1 to 5, default 1	1 to 5, default 1	0 to 2, default 0	Displays all non-reserved S7 connection resources as free connection resources.
313C 313C-2 PtP 313C-2 DP	8	1 to 7, default 1	1 to 7, default 1	0 to 4, default 0	
314C-2 PtP 314C-2 DP	12	1 to 11, default 1	1 to 11, default 1	0 to 8, default 0	
312	6	1 to 5, default 1	1 to 5, default 1	0 to 2, default 0	
314	12	1 to 11, default 1	1 to 11, default 1	0 to 8, default 0	
315-2 DP 315-2 PN/DP	16	1 to 15, default 1	1 to 15, default 1	0 to 12, default 0	
317-2 DP 317-2 PN/DP	32	1 to 31, default 1	1 to 31, default 1	0 to 30, default 0	
319-3 PN/DP	32	1 to 31, default 1	1 to 31, default 1	0 to 30, default 0	

Note

When using a CPU 315-2 PN/DP, you can configure up to 14 connection resources for S7 communication in NetPro: These connections are then reserved. For CPU 317-2 PN/DP and CPU 319-3 PN/DP, you can configure a maximum of 16 connection resources for S7 communication in NetPro.

3.4.4 Connection resources for routing

Number of connection resources for routing

The CPUs with DP interface provide a different number of connection resources for the routing function:

Table 3- 11 Number of routing connection resources (for DP/PN CPUs)

CPU	As of firmware version	Number of connections for routing
31xC, CPU 31x	2.0.0	Max. 4
317-2 DP	2.1.0	Max. 8
31x-2 PN/DP	2.2.0	Interface X1 configured as: <ul style="list-style-type: none"> • MPI: Max. 10 • DP master Max. 24 • DP slave (active): Max. 14 Interface X2 configured as: <ul style="list-style-type: none"> • PROFINET: Max. 24
319-3 PN/DP	2.4.0	Interface X1 configured as: <ul style="list-style-type: none"> • MPI: Max. 10 • DP master Max. 24 • DP slave (active): Max. 14 Interface X2 configured as: <ul style="list-style-type: none"> • DP master Max. 24 • DP slave (active): Max. 14 Interface X3 configured as: <ul style="list-style-type: none"> • PROFINET: Max. 48

Example of a CPU 314C-2 DP

The CPU 314C-2 DP provides 12 connection resources (see Table 3-10)::

- Reserve two connection resources for PG communication.
- Reserve three connection resources for OP communication.
- Reserve one connection resource for S7-based communication.

This leaves six connection resources available for other communication service, e.g. S7 communication, OP communication, etc.

In addition 4 routing connections via the CPU are possible.

Example for a CPU 317-2 PN/DP / CPU 319-3 PN/DP

The CPU 317-2 PN/DP and CPU 319-3 PN/DP provide you with 32 connection resources (refer to Table 3-10):

- Reserve four connection resources for PG communication.
- Reserve six connection resources for OP communication.
- Reserve two connection resources for S7-based communication.
- In NetPro you configure eight S7 connection resources for S7 communication via the integrated PROFINET interface

This leaves 12 S7 connections available for arbitrary communication services such as S7 communication, OP communication, etc.

However, only a maximum of 16 connection resources for S7 communication at the integrated PN interface can be configured in NetPro.

In addition, there are another 24 routing connections available for the CPU 317-2 PN/DP, and another 48 routing connections for the CPU 3193 PN/DP, which do not affect the aforementioned S7 connections.

However, take the interface-specific maximum numbers into account (refer to Table 3-11).

3.5 DPV1

New automation and process engineering tasks require the range of functions performed by the existing DP protocol to be extended. In addition to cyclical communication functions, acyclical access to non-S7 field devices is another important requirement of our customers, and was implemented in the standard EN 50170. In the past, acyclical access was only possible with S7 slaves. The distributed I/O standard EN 50170 has been further developed. All the changes concerning new DPV1 functions are included in IEC 61158/ EN 50170, volume 2, PROFIBUS.

Definition DPV1

The term DPV1 is defined as a functional extension of the acyclical services (to include new interrupts, for example) provided by the DP protocol.

Availability

All CPUs with DP interface(s) and serving as DP masters feature the enhanced DPV1 functionality.

Note

If you want to use the CPU as an intelligent slave, remember that it does not have DPV1 functionality.

Requirement for using the DPV1 functionality with DP slaves

For DPV1 slaves from other vendors, you will need a GSD file conforming to EN 50170, revision 3 or later.

Extended functions of DPV1

- Use of any DPV1 slaves from external vendors (in addition to the existing DPV0 and S7 slaves, of course).
- Selective handling of DPV1-specific interrupt events by new interrupt blocks.
- Reading/writing SFBs that conform to standards to the data record (although this can only be used for centralized modules).
- User-friendly SFB for reading diagnostics.

Interrupt blocks with DPV1 functionality

Table 3- 12 Interrupt blocks with DPV1 functionality

OB	Functionality
OB 40	Process interrupt
OB 55	Status interrupt
OB 56	Update interrupt
OB 57	Vendor-specific interrupt
OB 82	Diagnostic interrupt

Note

You can now also use organizational blocks OB40 and OB82 for DPV1 interrupts.

System blocks with DPV1 functionality

Table 3- 13 System function blocks with DPV1 functionality

SFB	Functionality
SFB 52	Read data record from DP slave/IO device or centralized module
SFB 53	Write data record to DP slave/IO device or centralized module
SFB 54	Read additional alarm information from a DP slave/IO device or a centralized module in the relevant OB
SFB 75	Send alarm to the DP master

Note

You can also use SFB 52 to SFB 54 for centralized I/O modules. SFB 52 to SFB 54 can also be used for PROFINET IO.

Reference

For further information on the blocks mentioned earlier, refer to the reference manual *System Software for S7-300/400: System and Standard Software*, or directly to the *STEP 7 Online Help*.

See also

PROFIBUS DP (Page 34)

Memory concept

4.1 Memory areas and retentivity

4.1.1 CPU memory areas

The three memory areas of your CPU:

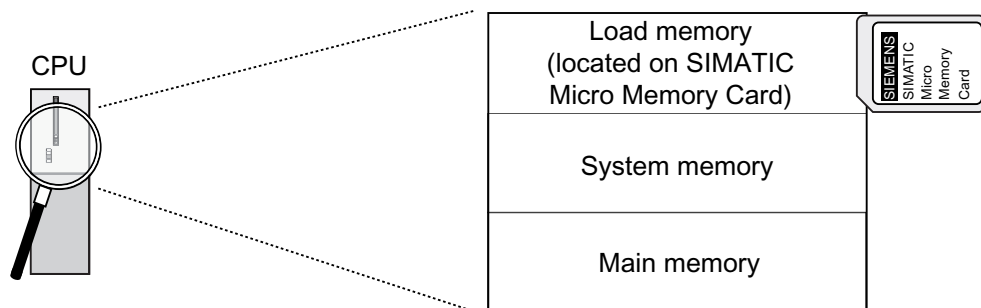

Load memory

The load memory is located on the SIMATIC Micro Memory Card. The size of the load memory corresponds exactly to the size of the SIMATIC Micro Memory Card. It is used to store code blocks, data blocks and system data (configuration, connections, module parameters, etc.). Blocks that are identified as not relevant for the execution are stored exclusively in the load memory. You can also store all the configuration data for your project on the SIMATIC Micro Memory Card.

Note

You must have inserted a SIMATIC Micro Memory Card into the CPU to enable the download of user programs and operation of the CPU.

System memory

The RAM system memory is integrated in the CPU and cannot be expanded.

It contains

- the address areas for address area memory bits, timers and counters
- the process image of the I/Os
- local data

Work memory

The work memory is integrated in the CPU and cannot be extended. It is used to run the code and process user program data. Programs only run in the work memory and system memory.

4.1.2 Retentivity of load memory, system memory and RAM

Your CPU is equipped with a service-free retentive memory, i.e., its operation does not require a buffer battery. Data is kept in retentive memory across POWER OFF and restart (warm start).

Retentive data in load memory

Your program in load memory is always retentive: It is stored on the SIMATIC Micro Memory Card, where it is protected against power failure or CPU memory restart

Retentive data in system memory

In your configuration (Properties of CPU, Retentivity tab), specify which part of memory bits, timers and counters should be kept retentive and which of them are to be initialized with "0" on restart (warm restart).

The diagnostics buffer, MPI address (and transmission rate) and operating hour counter data are generally written to the retentive memory area on the CPU. Retentivity of the MPI address and baud rate ensures that your CPU can continue to communicate, even after a power loss, memory reset or loss of communication parameters (e.g. due to removal of the SIMATIC Micro Memory Card or deletion of communication parameters).

Retentive data in work memory

Therefore, the contents of retentive DBs are always retentive at restart and POWER ON/OFF. Retentive data blocks can be uploaded to the work memory in accordance with the maximum limit allowed by the work memory.

In the case of CPU versions V2.0.12 and higher, non-retentive DBs are also supported. Non-retentive DBs are initialized from the load memory with their initial values whenever a restart is performed or when the power is switched off and then on again. Non-retentive data blocks and code blocks can be loaded in accordance with the maximum work memory limit.

Table 4- 1 Retentivity of the work memory

CPUs	Length of the non-volatile work memory for retentive data blocks
CPU 312	32 KB
CPU 313, 314	64 KB
CPU 315	128 KB
CPU 317	256 KB
CPU 319	700 KB

See also

Properties of the SIMATIC Micro Memory Card (Page 112)

4.1.3 Retentivity of memory objects

Retentive behavior of memory objects

The table below shows the retentive behavior of memory objects during specific operating state transitions.

Table 4- 2 Retentivity behavior of memory objects (applies to all CPUs with DP/MPI-SS)

Memory object	Operating state transition		
	POWER ON / POWER OFF	STOP → RUN	CPU memory reset
User program/data (load memory)	X	X	X
<ul style="list-style-type: none"> Retentive behavior of DBs for CPUs with firmware < V2.0.12 	X	X	–
<ul style="list-style-type: none"> Retentive behavior of DBs for CPUs with firmware >= V2.0.12 	Can be set in the properties of the DBs in STEP 7 V5.2 + SP1 or higher.		–
Flag bits, timers and counters configured as retentive data	X	X	–
Diagnostics buffers, operating hour counters	X ¹	X	X
MPI address, transmission rate (or also DP address, transmission rate of the MPI/DP interface of CPU 315-2 PN/DP and CPU 317 and CPU 319, if these are configured as DP nodes).	X	X	X

x = retentive; – = not retentive

¹ Only the last 100 entries are retained in the diagnostics buffer after POWER OFF / POWER ON.

Retentive behavior of a DB for CPUs with firmware < V2.0.12

For these CPUs, the contents of the DBs are always retentive at POWER ON/OFF or STOP-RUN.

Retentive behavior of a DB for CPUs with firmware >= V2.0.12

These CPUs support the generation of data blocks with "NON-Retain" (not retentive) property.

Data blocks assigned the "NON-Retain" property are initialized with their start values when power is cycled off and on and when the CPU goes from STOP to RUN.

You have two options of assigning the "NON-Retain" property to a DB:

- STEP 7, V5.2 + SP1 or higher: Activate the NON-Retain function in the DB properties
- SFC 82 "Crea_DBL" (generation of a DB in load memory): Set bit 2 = "1" at the ATTRIB parameter

Table 4- 3 Retentive behavior of DBs for CPUs with firmware >= V2.0.12

At POWER ON/OFF or restart (warm start) of the CPU, the DB should	
receive the initial values (non-retentive DB)	retain the actual values (retentive DB)
Reason: At POWER ON/OFF and restart (STOP-RUN) of the CPU, the actual values of the DB are non-retentive. The DB receives the start values from load memory.	Reason: At POWER OFF/ON and restart (STOP-RUN) of the CPU, the actual values of the DB are retained.
Requirement in STEP 7: <ul style="list-style-type: none"> • The "Non-Retain" check box is activated in the DB properties. <p style="text-align: center;">or</p> <ul style="list-style-type: none"> • a non-retentive DB was generated using SFC 82 "CREA_DBL" and the corresponding block attribute (ATTRIB -> NON_RETAIN bit). 	Requirement in STEP 7: <ul style="list-style-type: none"> • The "Non-Retain" check box is deactivated in the DB properties. <p style="text-align: center;">or</p> <ul style="list-style-type: none"> • a retentive DB was generated using SFC 82 "CREA_DBL".

Retentivity of the work memory

CPUs	Length of the non-volatile work memory for retentive data blocks
CPU 312	32 KB
CPU 313, 314	64 KB
315	128 KB
317	256 KB
319	700 KB

The remainder of work memory is available for code blocks or for non-retentive DBs.

4.1.4 Address areas of system memory

The system memory of the S7 CPUs is divided into operand areas. In a corresponding operation of your user program, you address data directly in the relevant address area.

Address areas of system memory

Table 4- 4 Address areas of system memory

Address areas	Description
Process image of inputs	At every start of an OB1 cycle, the CPU reads the values at the input of the input modules and saves them the process image of inputs.
Process image of outputs	During its cycle, the program calculates the values for the outputs and writes these to the process image of outputs. At the end of the OB1 cycle, the CPU writes the calculated output values to the output modules.
Bit memory	This area provides memory for saving the intermediate results of a program calculation.
Timers	Timers are available in this area.
Counters	Counters are available in this area.
Local data	Temporary data in a code block (OB, FB, FC) is saved to this memory area while the block is being edited.
Data blocks	See <i>Recipes and measurement value logs</i>

Reference

The address areas of your CPU are listed in the *Instruction list for CPUs 31xC and 31x*.

I/O process image

When the user program addresses the input (I) and output (O) address areas, it does not query the signal states of digital signal modules. Instead, it rather accesses a memory area in CPU system memory. This particular memory area is the process image.

The process image is organized in two sections: The process image of inputs, and the process image of outputs.

Advantages of the process image

Process image access, compared to direct I/O access, offers the advantage that a consistent image of process signals is made available to the CPU during cyclic program execution. When the signal status at an input module changes during program execution, the signal status in the process image is maintained until the image is updated in the next cycle. Moreover, since the process image is stored in CPU system memory, access is significantly faster than direct access to the signal modules.

Process image update

The operating system updates the process image periodically. The figure below shows the sequence of this operation within a cycle.

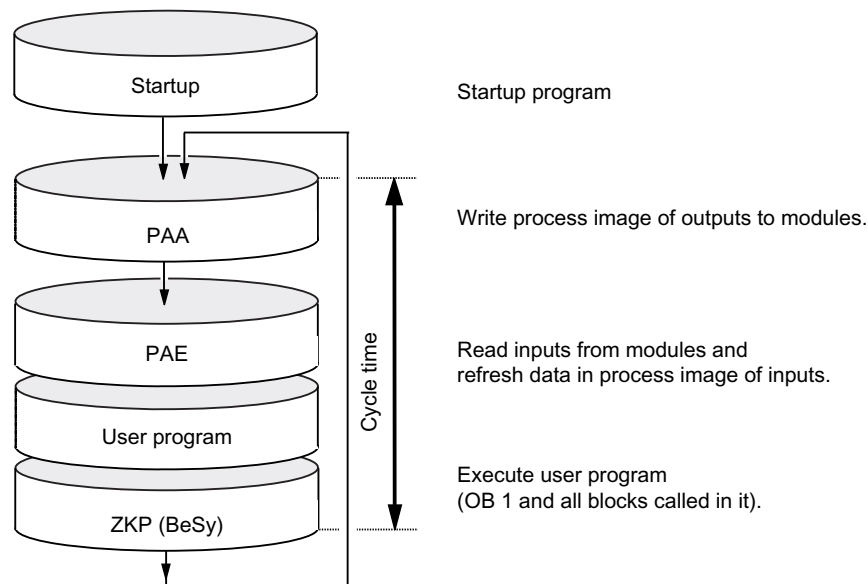

Configurable process image of the CPUs

STEP 7 lets you define a user-specific size of the process image of the inputs/outputs for the following CPUs:

CPU	Firmware	Size that can be set
CPU 315-2 PN/DP	V2.5 or higher	From 0 to 2048 bytes
CPU 317-2 DP	V2.5 or higher	From 0 to 2048 bytes
CPU 317-2 PN/DP	V2.3 or higher	From 0 to 2048 bytes
CPU 319-3 PN/DP	V2.7 or higher	From 0 to 4096 bytes

Note the information below:

Note

Currently, the dynamic setting of the process image only affects its update at the scan cycle control point. That is, the process image of inputs is only updated up to the set PII size with the corresponding values of the peripheral input modules existing within this address area, or the values of the process image of outputs up to the set PIO size are written to the peripheral output modules existing within this address area.

This set size of the process image is ignored with respect to STEP 7 commands used to access the process image (for example U I100.0, L EW200, = Q20.0, T AD150, or also corresponding indirect addressing commands). However, up to the maximum size of the process image (that is, up to I/O byte 2047 or up to byte 4095 at the CPU 319-3 PN/DP V2.7 and higher), these commands do not return any synchronous access errors, but rather access the permanently available internal memory area of the process image.

The same applies to the use of actual parameters of block calls from the I/O area (area of the process image).

Particularly if these process image limits were changed, you should check to which extent your user program accesses the process image in the area between the set and the maximum process image size. If access to this area continues the user program may not detect changes at the inputs of the I/O module, or actually fails to write output data to the output module and does not generate an error message.

You should also note that certain CPs may only be addressed outside of the process image.

Local data

Local data store:

- the temporary variables of code blocks
- the start information of the OBs
- transfer parameters
- intermediate results

Temporary Variables

When you create blocks, you can declare temporary variables (TEMP) which are only available during block execution and then overwritten again. These local data have fixed length in each OB. Local data must be initialized prior to the first read access. Each OB also requires 20 bytes of local data for its start information. Local data access is faster compared to access to data in DBs.

The CPU is equipped with memory for storing temporary variables (local data) of currently executed blocks. The size of this memory area depends on the CPU. It is distributed in partitions of equal size to the priority classes. Each priority class has its own local data area.

 CAUTION
--

<p>All temporary variables (TEMP) of an OB and its nested blocks are stored in local data. When using complex nesting levels for block processing, you may cause an overflow in the local data area. The CPUs will change to STOP mode if you exceed the permissible length of local data for a priority class. Make allowances for local data space required for synchronous error OBs. This is assigned to the respective triggering priority class.</p>
--

See also

Retentivity of load memory, system memory and RAM (Page 104)

4.1.5 Properties of the SIMATIC Micro Memory Card

The SIMATIC Micro Memory Card as memory module for the CPU

The memory module used on your CPU is a SIMATIC Micro Memory Card. You can use MMCs as load memory or as portable data volume.

Note

The CPU requires the SIMATIC Micro Memory Card for operation.

What is stored on the SIMATIC Micro Memory Card

The following data can be stored on the SIMATIC Micro Memory Card:

- User program, i.e., all blocks (OBs, FCs, FCs, DBs) and system data
- Archives and recipes
- Configuration data (STEP 7 projects)
- Data for operating system update and backup

Note

You can either store user and configuration data or the operating system on the SIMATIC Micro Memory Card.

Properties of a SIMATIC Micro Memory Card

The SIMATIC Micro Memory Card ensures maintenance-free and retentive operation of these CPUs.

 CAUTION
Data on a SIMATIC Micro Memory Card can be corrupted if you remove the card while it is being accessed by a write operation. In this case, you may have to delete the SIMATIC Micro Memory Card on your PG, or format the card in the CPU. Never remove a SIMATIC Micro Memory Card in RUN mode. Always remove it when power is off, or when the CPU is in STOP state, and when the PG is not writing to the card. When the CPU is in STOP mode and you cannot not determine whether or not a PG is writing to the card (e.g., load/delete block), disconnect the communication lines.

SIMATIC Micro Memory Card copy protection

Your SIMATIC Micro Memory Card has an internal serial number that implements an MMC copy protection. You can read this serial number from the SSL partial list 011C_H index 8 using SFC 51 "RDSYSST." If the reference and actual serial number of your SIMATIC Micro Memory Card are not the same, program a STOP command in a know-how-protected module, for example.

Useful life of a SIMATIC Micro Memory Card

The life of an SIMATIC Micro Memory Card depends mainly on the following factors:

1. The number of delete or programming operations,
2. External influences such as ambient temperature.

At ambient temperatures up to 60 °C, a maximum of 100,000 delete/write operations can be performed on a SIMATIC Micro Memory Card.

 CAUTION
To prevent data losses, do not exceed this maximum of delete/write operations.

Reference

Additional information:

- on the *SSL parts list*, refer to the *CPU 31xC and CPU 31x Instruction List*, or to the *S7-300/400 System Software, System and Standard Functions Reference Manual*.
- on resetting the CPU, refer to the *Operating Instructions CPU 31xC and CPU31x, Commissioning, Commissioning Modules, CPU Memory Reset by means of Mode Selector Switch*

See also

- Operating and display elements: CPU 31xC (Page 17)
- Operating and display elements: CPU 312, 314, 315-2 DP: (Page 21)
- Operating and display elements: CPU 317-2 DP (Page 23)
- Operating and display elements: CPU 31x-2 PN/DP (Page 25)
- Operating and display elements: CPU 319-3 PN/DP (Page 27)

4.2 Memory functions

4.2.1 General: Memory functions

Memory functions

Memory functions are used to generate, modify or delete entire user programs or specific blocks. You can also ensure that your project data are retained by archiving these. If you created a new user program, use a PG/PC to download the complete program to the SIMATIC Micro Memory Card.

4.2.2 Load user program from SIMATIC Micro Memory Card to the CPU

User program download

The entire user program data are downloaded from your PG/PC to the CPU by means of the SIMATIC Micro Memory Card. The previous content of the Micro Memory Card is deleted in the process. Blocks use the load memory area as specified under "Load memory requirements" in "General block properties".

The figure shows the load and work memory of the CPU

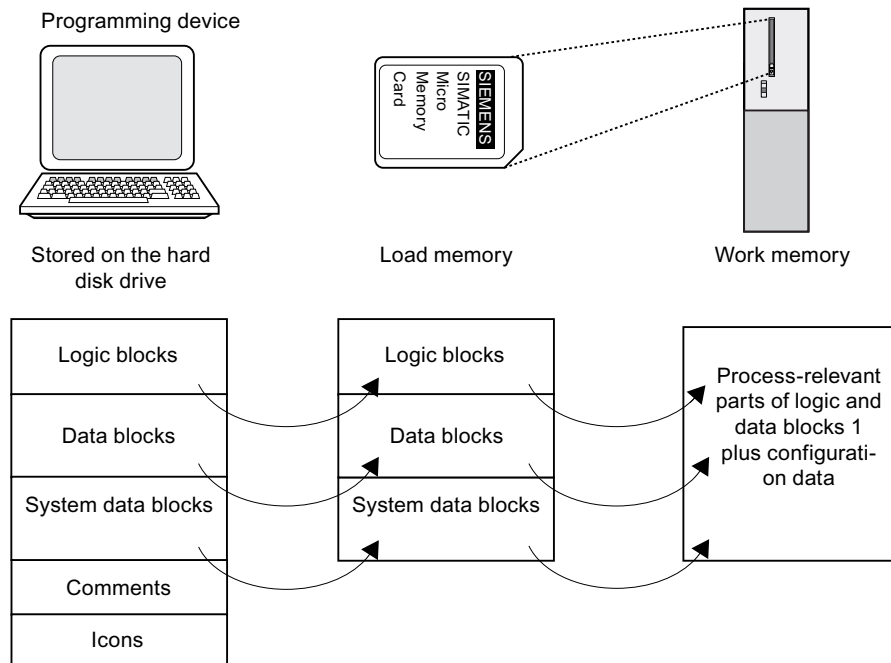

¹: If not all of the work memory area is retentive, the retentive area is indicated in STEP 7 module status as retentive memory. You cannot run the program until all the blocks are downloaded.

Note

This function is only permitted when the CPU is in STOP mode. Load memory is cleared if the load operation could not be completed due to power loss or illegal block data.

4.2.3 Handling with modules

4.2.3.1 Download of new blocks or delta downloads

There are two ways to download additional user blocks or download deltas:

- Download of blocks: You already created a user program and downloaded it to the CPU via the SIMATIC Micro Memory Card. You then want to add new blocks to the user program. In this case you do not need to reload the entire user program to the MCC. Instead you only need to download the new blocks to the SIMATIC Micro Memory Card (this reduces the download times for highly complex programs.)
- Delta download: In this case, you only download the deltas in the blocks of your user program. In the next step, perform a delta download of the user program, or only of the changed blocks to the SIMATIC Micro Memory Card, using the PG/PC.

 WARNING
--

The delta down of block / user programs overwrites all data stored under the same name on the SIMATIC Micro Memory Card.
--

The data of dynamic blocks are transferred to RAM and activated after the block is downloaded.

4.2.3.2 Uploading blocks

Uploading blocks

Unlike download operations, an upload operation is the transfer of specific blocks or a complete user program from the CPU to the PG/PC. The block content is here identical with that of the last download to the CPU. Dynamic DBs form the exception, because their actual values are transferred. An upload of blocks or of the user program from the CPU in STEP 7 does not influence CPU memory.

4.2.3.3 Deleting blocks

Deleting blocks

When you delete a block, it is deleted from load memory. In STEP 7, you can also delete blocks with the user program (DBs also with SFC 23 "DEL_DB"). RAM used by this block is released.

4.2.3.4 Compressing blocks

Compressing blocks

When data are compressed, gaps which have developed between memory objects in load memory/RAM as a result of load/delete operations will be eliminated. This releases free memory in a continuous block. Data compression is possible when the CPU is in RUN or in STOP.

4.2.3.5 Promming (RAM to ROM)

Promming (RAM to ROM)

When writing the RAM content to ROM, the actual values of the DBs are transferred from RAM to load memory to form the start values for the DBs.

Note

This function is only permitted when the CPU is in STOP mode. Load memory is cleared if the function could not be completed due to power loss.

4.2.4 CPU memory reset and restart

CPU memory reset

After the insertion/removal of a Micro Memory Card, a CPU memory reset restores defined conditions for CPU restart (warm start). A CPU memory reset rebuilds the CPU's memory management. Blocks in load memory are retained. All dynamic runtime blocks are transferred once again from load memory to work memory, in particular to initialize the data blocks in work memory (restore initial values).

Restart (warm start)

- All retentive DBs retain their actual value (non-retentive DBs are also supported by CPUs with firmware \geq V2.0.12. Non-retentive DBs receive their initial values).
- The values of all retentive M, C, T are retained.
- All non-retentive user data are initialized:
 - M, C, T, I, O with "0"
- All run levels are initialized.
- The process images are deleted.

Reference

Also refer to *CPU memory reset by means mode selector switch* in the section *Commissioning* in the *CPU 31xC and CPU 31x Operating Instructions*.

4.2.5 Recipes

Introduction

A recipe represents a collection of user data. You can implement a simple recipe concept using static DBs. In this case, the recipes should have the same structure (length). One DB should exist per recipe.

Processing sequence

Recipe is written to load memory:

- The various data records of recipes are created as static DBs in STEP 7 and then downloaded to the CPU. Therefore, recipes only use load memory, rather than work memory.

Working with recipe data:

- SFC83 "READ_DBL" is called in the user program to copy the data record of a current recipe from the DB in load memory to a static DB that is located in work memory. As a result, the work memory only has to accommodate the data of one record. The user program can now access data of the current recipe. The figure below shows how to handle recipe data:

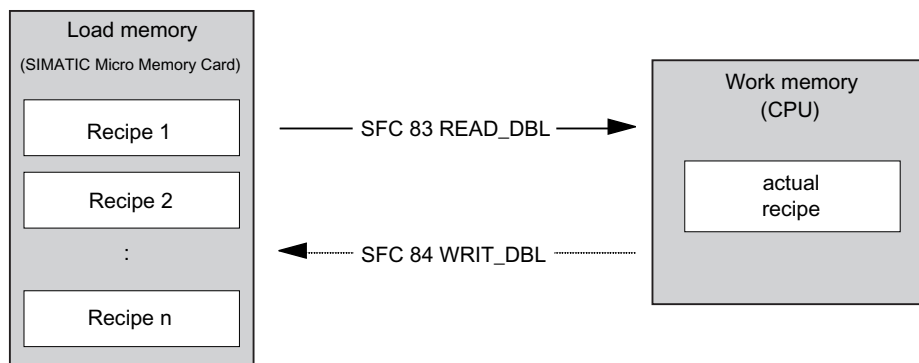

Saving a modified recipe:

- The data of new or modified recipe data records generated during program execution can be written to load memory. To do this, call SFC 84 "WRIT_DBL" in the user program. The data written to load memory are portable and retentive on CPU memory reset. You can backup modified records (recipes) by uploading and saving these in a single block to the PG/PC.

Note

Active system functions SFC82 to 84 (active access to the SIMATIC Micro Memory Card) have a distinct influence on PG functions (for example, block status, variable status, download block, upload, open.) This typically reduces performance (compared to passive system functions) by the factor 10.

Note

To prevent data losses, do not exceed this maximum of delete/write operations. Also refer to the SIMATIC Micro Memory Card (MMC) section in the "Structure and Communication Connections of a CPU" chapter.

 **CAUTION**

Data on a SIMATIC Micro Memory Card can be corrupted if you remove the card while it is being accessed by a write operation. In this case, you may have to delete the SIMATIC Micro Memory Card on your PG, or format the card in the CPU. Never remove a SIMATIC Micro Memory Card in RUN mode. Always remove it when power is off, or when the CPU is in STOP state, and when the PG is not writing to the card. When the CPU is in STOP mode and you cannot not determine whether or not a PG is writing to the card (e.g., load/delete block), disconnect the communication lines.

4.2.6 Measured value log files

Introduction

Measured values are generated when the CPU executes the user program. These values are to be logged and analyzed.

Processing sequence

Acquisition of measured values:

- The CPU writes all measured values to a DB (for alternating backup mode in several DBs) which is located in work memory.

Measured value logging:

- Before the data volume can exceed work memory capacity, you should call SFC 84 "WRIT_DBL" in the user program to swap measured values from the DB to load memory. The figure below shows how to handle measured value log files:

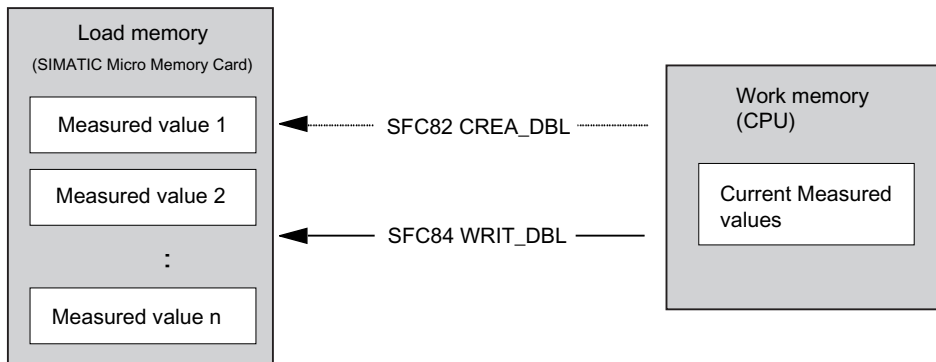

- You can call SFC 82 "CREA_DBL" in the user program to generate new (additional) static DBs in load memory which do not require work memory space.

Reference

For detailed information on SFC 82, refer to the *System Software for S7-300/400, System and Standard Functions Reference Manual*, or directly to the STEP 7 Online Help.

Note

SFC 82 is terminated and an error message is generated if a DB already exists under the same number in load memory and/or work memory.

The data written to load memory are portable and retentive on CPU memory reset.

Evaluation of measured values:

- Measured value DBs saved to load memory can be uploaded and evaluated by other communication partners (PG, PC, for example).

Note

Active system functions SFC82 to 84 (active access to the SIMATIC Micro Memory Card) have a distinct influence on PG functions (for example, block status, variable status, download block, upload, open.) This typically reduces performance (compared to passive system functions) by the factor 10.

Note

For CPUs with firmware V2.0.12 or higher, you can also generate non-retentive DBs using SFC 82 (parameter ATTRIB -> NON_RETAIN bit.)

Note

To prevent data losses, do not exceed this maximum of delete/write operations. For further information, refer to the Technical Data of the SIMATIC Micro Memory in the General Technical Data of your CPU.

 CAUTION
--

Data on a SIMATIC Micro Memory Card can be corrupted if you remove the card while it is being accessed by a write operation. In this case, you may have to delete the SIMATIC Micro Memory Card on your PG, or format the card in the CPU. Never remove a SIMATIC Micro Memory Card in RUN mode. Always remove it when power is off, or when the CPU is in STOP state, and when the PG is not writing to the card. When the CPU is in STOP mode and you cannot not determine whether or not a PG is writing to the card (e.g., load/delete block), disconnect the communication lines.
--

4.2.7 Backup of project data to SIMATIC Micro Memory Card

Function principles

Using the **Save project to Memory Card** and **Fetch project from Memory Card** functions, you can save all project data to a SIMATIC Micro Memory Card, and retrieve these at a later time. For this operation, the SIMATIC Micro Memory Card can be located in a CPU or in the MMC adapter of a PG or PC.

Project data is compressed before it is saved to a SIMATIC Micro Memory Card, and uncompressed on retrieval.

Note

In addition to project data, you may also have to store your user data on the MMC. You should therefore first verify SIMATIC Micro Memory Card memory space.

A message warns you of insufficient memory capacity on your SIMATIC Micro Memory Card.

The volume of project data to be saved corresponds with the size of the project's archive file.

Note

For technical reasons, you can only transfer the entire contents (user program and project data) using the **Save project to memory card** action.

Cycle and reaction times

5.1 Overview

Overview

This section contains detailed information about the following topics:

- Cycle time
- Reaction time
- Interrupt response time
- Sample calculations

Reference: Cycle time

You can view the cycle time of your user program on the PG. For further information, refer to the *STEP 7 Online Help*, or to the *Configuring Hardware and Connections in STEP 7 Manual*

Reference: Execution time

can be found in the *S7-300 Instruction List for CPUs 31xC and 31x*. This tabular list contains the execution times for all

- STEP 7 instructions the relevant CPU can execute,
- the SFCs / SFBs integrated in the CPUs,
- the IEC functions which can be called in STEP 7.

5.2 Cycle time

5.2.1 Overview

Introduction

This section explains what we mean by the term "cycle time", what it consists of, and how you can calculate it.

Meaning of the term cycle time

The cycle time represents the time that an operating system needs to execute a program, that is, one OB 1 cycle, including all program sections and system activities interrupting this cycle. This time is monitored.

Time slice model

Cyclic program processing, and therefore user program execution, is based on time shares. To clarify these processes, let us assume that every time share has a length of precisely 1 ms.

Process image

During cyclic program processing, the CPU requires a consistent image of the process signals. To ensure this, the process signals are read/written prior to program execution. Subsequently, the CPU does not address input (I) and output (O) address areas directly at the signal modules, but rather accesses the system memory area containing the I/O process image.

Sequence of cyclic program processing

The table and figure below show the phases in cyclic program processing.

Table 5- 1 Cyclic program processing

Step	Sequence
1	The operating system initiates cycle time monitoring.
2	The CPU copies the values of the process image of outputs to the output modules.
3	The CPU reads the status at the inputs of the input modules and then updates the process image of inputs.
4	The CPU processes the user program in time shares and executes program instructions.
5	At the end of a cycle, the operating system executes queued tasks, for example, loading and deleting blocks.
6	The CPU then returns to the start of the cycle, and restarts cycle time monitoring.

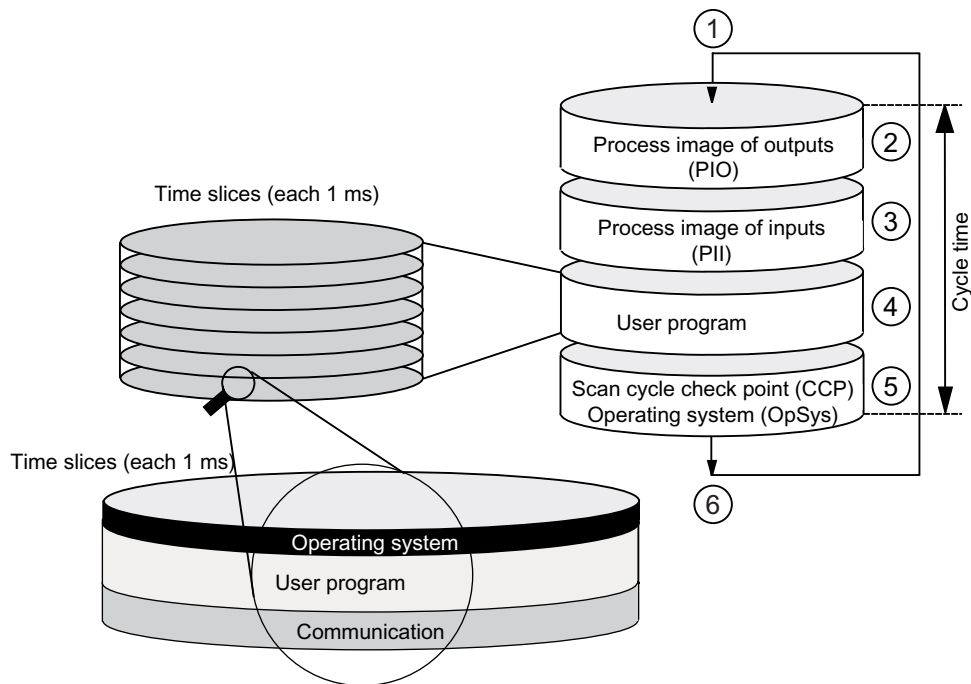

PIO: Process Image of Outputs
 PII: Process Image of Inputs
 SCC: Scan cycle check point
 OpSys: Operating system

In contrast to S7-400 CPUs, the S7-300 CPUs data only allow data access from an OP / TP (monitor and modify functions) at the scan cycle check point (Data consistency, see the Technical Data). Processing of the user program is not interrupted by the monitor and modify functions.

Extending the cycle time

Always make allowances for the extension of the cycle time of a user program due to:

- Time-based interrupt processing
- Process interrupt processing
- Diagnostics and error processing
- Communication with PGs, Operator Panels (OPs) and connected CPs (for example, Ethernet, PROFIBUS DP)
- Testing and commissioning such as status/controlling of variables or block status functions.
- Transfer and deletion of blocks, compressing user program memory
- Write/read access to the Micro Memory Card, using SFC 82 to 84 in the user program
- S7 communication via integrated PROFINET interface
- PROFINET CBA communication by means of the PROFINET interface (system load, SFC call, updating on the cycle control point)
- PROFINET IO communication via PROFINET interface (system load)

5.2.2 Calculating the cycle time

Introduction

The cycle time is derived from the sum of the following influencing factors.

Process image update

The table below shows the time a CPU requires to update the process image (process image transfer time). The times specified might be prolonged as a result of interrupts or CPU communication. The process image transfer time is calculated as follows:

Table 5- 2 Formula for calculating the process image (PI) transfer time

The transfer time of the process image is calculated as follows:	
Base load K	+ number of bytes in PI in module rack 0 x (A) + number of bytes in PI in module rack 1 to 3 x (B) + number of words in PI via DP x (D) + number of words in PI via PROFINET x (P) = Transfer time for the process image

Table 5- 3 CPU 31xC: Data for calculating the process image (PI) transfer time

Const.	Components	CPU 312C	CPU 313C	CPU 313C-2 DP	CPU 313C-2 PtP	CPU 314C-2 DP	CPU 314C-2 PtP
C	Base load	150 µs	100 µs	100 µs		100 µs	
A	Per byte in the rack 0	37 µs	35 µs	37 µs		37 µs	
B	per byte in module racks 1 to 3 *	-	43 µs	47 µs		47 µs	
D (DP only)	Per word in the DP area for the integrated DP interface	-	-	1 µs	-	1 µs	-

* + 60 µs per rack

5.2 Cycle time

Table 5- 4 CPU 31x: Data for calculating the process image (PI) transfer time

Const.	Components	CPU 312	CPU 314	CPU 315	CPU 317	CPU 319
K	Base load	150 µs	100 µs	100 µs	50 µs	2 µs
A	Per byte in Rack 0	37 µs	35 µs	37 µs	15 µs	15 µs
B	Per byte in module Racks 1 to 3	-	43 µs*	47 µs*	25 µs*	22 µs**
D (DP only)	Per word in the DP area for the integrated DP interface	-	-	2.5 µs	2.5 µs	2.5 µs
P (PROFINET only)	per WORD in the PROFINET area for the integrated PROFINET interface	-	-	46 µs	46 µs	2.5 µs

* + 60 µs per rack

** + 21 µs per rack

Extending the user program processing time

In addition to actually working through the user program, your CPU's operating system also runs a number of processes in parallel (such as timer management for the core operating system). These processes extend the processing time of the user program. The table below lists the multiplication factors required to calculate your user program processing time.

Table 5- 5 Extending the user program processing time

CPU	Factor
312C	1.06
313C	1.10
313C-2DP	1.10
313C-PtP	1.06
314C-2DP	1.10
314C-2PtP	1.09
312	1.06
314	1.10
315	1.10
317	1.07
319	1.05

Operating system processing time at the scan cycle check point

The table below shows the operating system processing time at the scan cycle checkpoint of the CPUs. These times are calculated without taking into consideration times for:

- Testing and commissioning routines, e.g. status/controlling of variables or block status functions
- Transfer and deletion of blocks, compressing user program memory
- Communication
- Writing, reading of the SIMATIC Micro Memory Card with SFC 82 to 84

Table 5- 6 Operating system processing time at the scan cycle check point

CPU	Cycle control at the scan cycle check point (CCP)
312C	500 µs
313C	500 µs
313C-2	500 µs
314C-2	500 µs
312	500 µs
314	500 µs
315	500 µs
317	150 µs
319	77 µs

Extension of the cycle time as a result of nested interrupts

Enabled interrupts also extend cycle time. Details are found in the table below.

Table 5- 7 Extended cycle time due to nested interrupts

Interrupt type	Process interrupt	Diagnostic Interrupt	Time-of-day interrupt	Delay interrupt	Watchdog interrupt
312C	700 µs	700 µs	600 µs	400 µs	250 µs
313C	500 µs	600 µs	400 µs	300 µs	150 µs
313C-2	500 µs	600 µs	400 µs	300 µs	150 µs
314C-2	500 µs	600 µs	400 µs	300 µs	150 µs
312	700 µs	700 µs	600 µs	400 µs	250 µs
314	500 µs	600 µs	400 µs	300 µs	150 µs
315	500 µs	600 µs	400 µs	300 µs	150 µs
317	190 µs	240 µs	200 µs	150 µs	90 µs
319	72 µs	87 µs	39 µs	26 µs	10 µs

The program runtime at interrupt level must be added to this time extension.

Extension of the cycle time due to error

Table 5- 8 Cycle time extension as a result of errors

Type of error	Programming errors	I/O access errors
312C	600 µs	600 µs
313C	400 µs	400 µs
313C2	400 µs	400 µs
314C-2	400 µs	400 µs
312	600 µs	600 µs
314	400 µs	400 µs
315	400 µs	400 µs
317	100 µs	100 µs
319	19 µs	23 µs

The interrupt OB processing time must be added to this extended time. The times required for multiple nested interrupt/error OBs are added accordingly.

5.2.3 Different cycle times

Overview

The cycle time (T_{cyc}) length is not the same in every cycle. The figure below shows different cycle times T_{cyc1} and T_{cyc2} . T_{cyc2} is longer than T_{cyc1} , because the cyclically executed OB1 is interrupted by a time-of-day interrupt OB (here: OB 10).

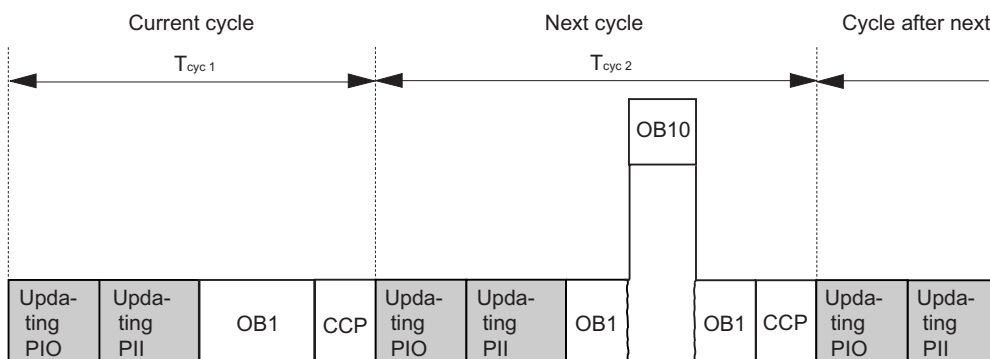

Block processing times may fluctuate

Fluctuation of the block processing time (e.g. OB 1) may also be a factor causing cycle time fluctuation, due to:

- conditional instructions,
- conditional block calls,
- different program paths,
- loops etc.

Maximum cycle time

In *STEP 7* you can modify the default maximum cycle time. OB80 is called on when this time expires. In this block you can specify the CPU's response to this timeout error. The CPU switches to STOP mode if OB80 does not exist in its memory.

5.2.4 Communications load

Configured communication load for PG/OP communication, S7 communication and PROFINET CBA

The CPU operating system continuously provides a specified percentage of total CPU processing performance (time-sharing technology) for communication tasks. Processing performance not required for communication is made available to other processes. In HW Config, you can specify a communication load value between 5% and 50%. Default value is 20%.

You can use the following formula for calculating the cycle time extension factor:

$$100 / (100 - \text{configured communication load in } \%)$$

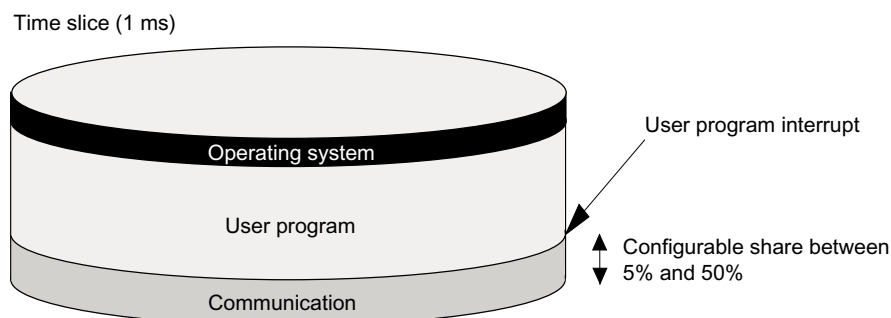

Example: 20 % communication load

In your hardware configuration, you have specified a communication load of 20%. The calculated cycle time is 10 ms. Using the above formula, the cycle time is extended by the factor 1.25.

Example: 50 % communication load

In your hardware configuration, you have specified a communication load of 50%. The calculated cycle time is 10 ms. Using the above formula, the cycle time is extended by the factor 2.

Physical cycle time depending on communication load

The figure below describes the non-linear dependency of the physical cycle time on communication load. In our sample we have chosen a cycle time of 10 ms.

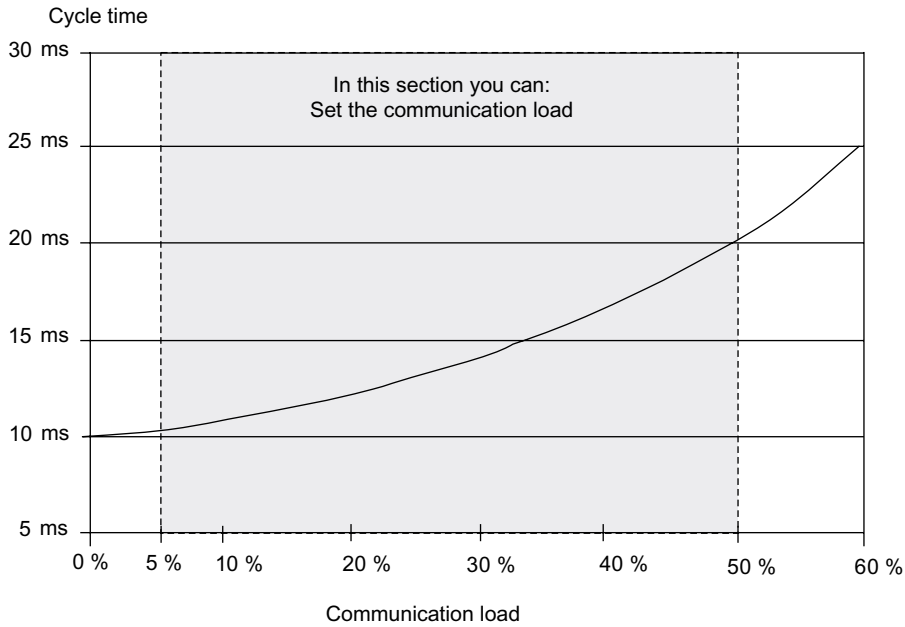

Influence on the physical cycle time

From the statistical viewpoint, asynchronous events, such as interrupts, occur more frequently within the OB1 cycle when the cycle time is extended as a result of communication load. This further extends the OB1 cycle. This extension depends on the number of events that occur per OB1 cycle and the time required to process these events.

Note

Change the value of the "communication load" parameter to check the effects on the cycle time at system runtime. You must consider the communication load when you set the maximum cycle time, otherwise timing errors may occur.

Tips

- Use the default setting wherever possible.
- Increase this value only if the CPU is used primarily for communications and if the user program is not time critical.
- In all other situations you should only reduce this value.

5.2.5 Cycle time extension as a result of testing and commissioning functions

Runtimes

The runtimes of the testing and commissioning functions are operating system runtimes, so they are the same for every CPU. Initially, there is no difference between process mode and testing mode. How the cycle time is extended as a result of active testing and commissioning functions is shown in the table below.

Table 5-9 Cycle time extension as a result of testing and commissioning functions

Function	CPU 31xC/ CPU 31x Without CPU 315-2 PN/DP, CPU 317-2 DP and CPU 319-3 DP/DP	CPU 315-2 PN/DP and CPU 317-2 PN/DP	CPU 319-3 PN/DP
Status variable	Typ. 50 μ s for each variable	Negligible	Negligible
Control variable	Typ. 50 μ s for each variable	Negligible	Negligible
Block status	Typ. 200 μ s for each monitored line	Typ. 50 μ s for each monitored line	Typ. 3 μ s for each monitored line + 3 x runtime of monitored block

Configuration during parameter assignment

For **process operation**, the maximum permissible cycle load by communication is not specified in "Cycle load by communication", but rather in "Maximum permitted increase of cycle time as a result of testing functions during process operation". Thus, the configured time is monitored absolutely in process mode and data acquisition is stopped if a timeout occurs. This is how STEP 7 stops data requests in loops before a loop ends, for example. When running in **Testing mode**, the complete loop is executed in every cycle. This can significantly increase cycle time.

5.2.6 Cycle extension through Component Based Automation (CBA)

By default, the operating system of your CPU updates the PROFINET interface as well as the DP interconnections at the cycle control point. However, if you deactivated these automatic updates during configuration (e.g. to obtain improved capabilities of influencing the time behavior of the CPU), you must perform the update manually. This is done by calling SFCs 112 to 114 at the appropriate times.

Reference

Information about SFC 112 to 114 is available in the *STEP 7 Online Help*.

Extending the OB1 cycle time

The OB1 cycle is extended by

- Increasing the number of PROFINET interconnections,
- Increasing the number of remote partners,
- Increasing the data volume and
- Increasing the transfer frequency

Note

The use of CBA with cyclical PROFINET interconnections requires the use of switches to maintain the performance data. 100-Mbit full-duplex operation is mandatory with cyclical PROFINET interconnections.

The following graphic shows the configuration that was used for the measurements.

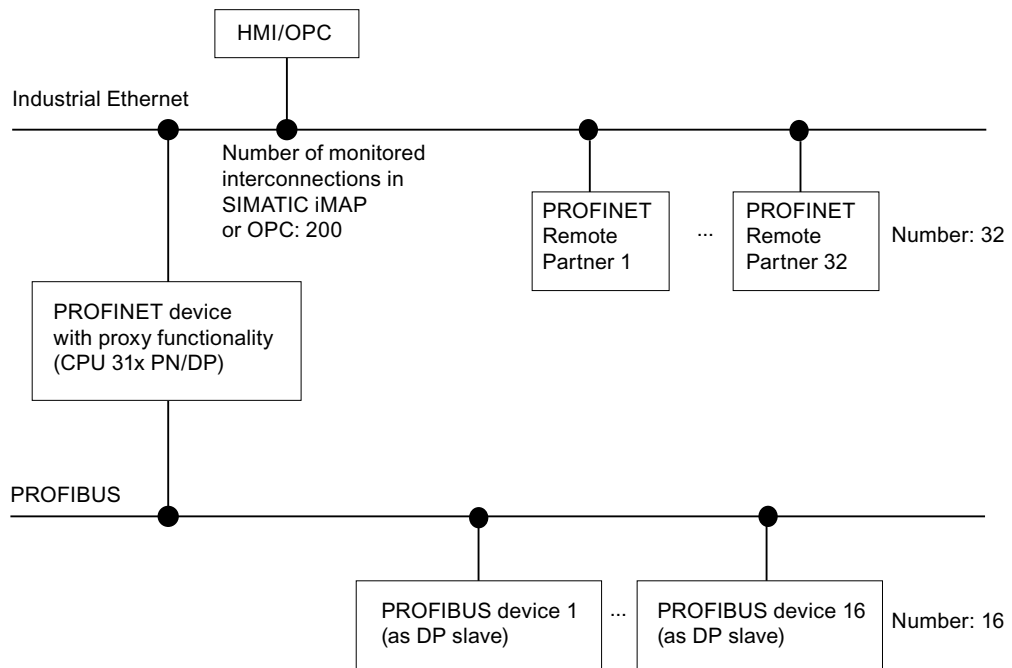

The upper graphic displays Incoming/outgoing remote connections	Quantity for CPU 315 and CPU 317	Quantity for CPU 319
Cyclical interconnection via Ethernet	200, scan cycle rate: Intervals of 10 ms	300, scan cycle rate: Intervals of 10 ms
Acyclic interconnection via Ethernet	100, scan cycle rate: Intervals of 500 ms	100, scan cycle rate: Intervals of 200 ms
Interconnections from the PROFINET device with proxy functionality to the PROFIBUS devices	16 x 4	16 x 4
Interconnections of PROFIBUS devices among each other	16 x 6	16 x 6

Additional marginal conditions

The maximum cycle load through communication in the measurement is 20 %.

The lower graphic shows that the OB1 cycle is influenced by increasing the cyclical PROFINET interconnections to remote partners at PROFINET:

Relationship between the OB 1 cycle and the number of PROFINET CBA interconnections

Cycle time in μs

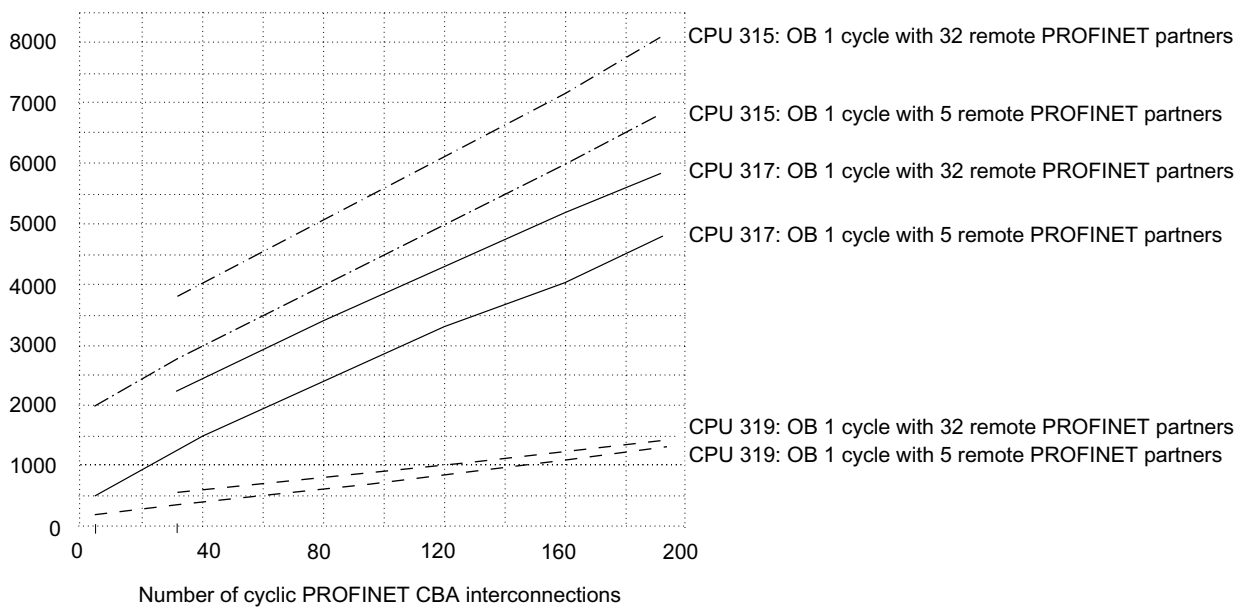

Base load through PROFIBUS devices

The 16 PROFIBUS devices with their interconnections among each other generate an **additional** base load of up to 1.0 ms.

Tips and notes

The upper graphic already includes the use of uniform values for the transfer frequency of all interconnections to a partner.

- The performance can drop by up to 50 % if the values are distributed to different frequency levels.
- The use of data structures and arrays in an interconnection instead of many single interconnections with simple data structures increases the performance.

5.3 Response time

5.3.1 Overview

Definition of response time

The response time is the time between the detection of an input signal and the change of a linked output signal.

Fluctuation width

The physical response time lies between the shortest and the longest response time. You must always reckon with the longest response time when configuring your system.

The shortest and longest response times are shown below, to give you an idea of the fluctuation width of the response time.

Factors

The response time depends on the cycle time and following factors:

- Delay of the inputs and outputs of signal modules or integrated I/O.
- Additional update times for PROFINET IO
- additional DP cycle times on PROFIBUS DP
- Execution in the user program

Reference

- The delay times are located in the technical data of the signal modules (*Module data Manual*).

Update times for PROFINET IO

If you configured your PROFINET IO system in STEP 7, STEP 7 calculates the update time for PROFINET IO. You can then view the PROFINET IO update times on your PG.

DP cycle times in the PROFIBUS DP network

If you have configured your PROFIBUS DP master system in STEP 7, STEP 7 calculates the typical DP cycle time to be expected. You can then view the DP cycle time of your configuration on the PG.

The figure below gives you an overview of the DP cycle time. In this example, let us assume that the data of each DP slave has an average length of 4 bytes.

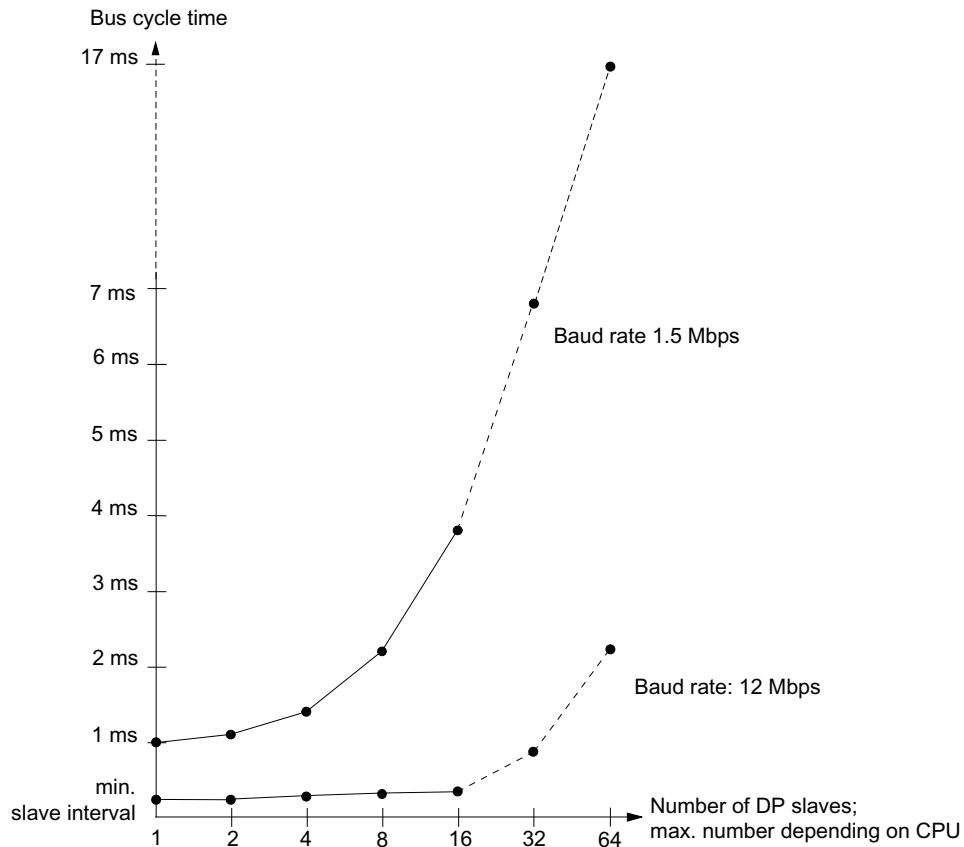

With multi-master operation on a PROFIBUS DP network, you must make allowances for the DP cycle time at each master. That is, you will have to calculate the times for each master separately and then add up the results.

5.3.2 Shortest response time

Conditions for the shortest response time

The figure below shows the conditions under which the shortest response time is reached.

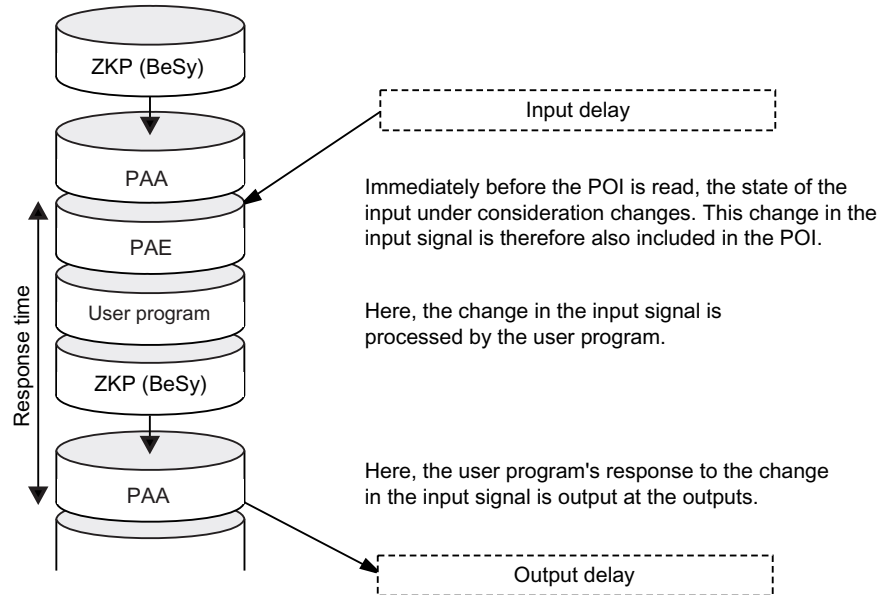

Calculation

The (shortest) response time is the sum of:

Table 5- 10 Formula: Shortest response time

- 1 x process image transfer time for the inputs
- + 1 x process image transfer time for the outputs
- + 1 x program processing time
- + 1 x operating system processing time at the SCC
- + I/O delay
- = **Shortest response time**

The result is equivalent to the sum of the cycle time plus the I/O delay times.

See also

Overview (Page 137)

5.3.3 Longest response time

Conditions for the longest response time

The figure below shows the conditions under which the longest response time is reached.

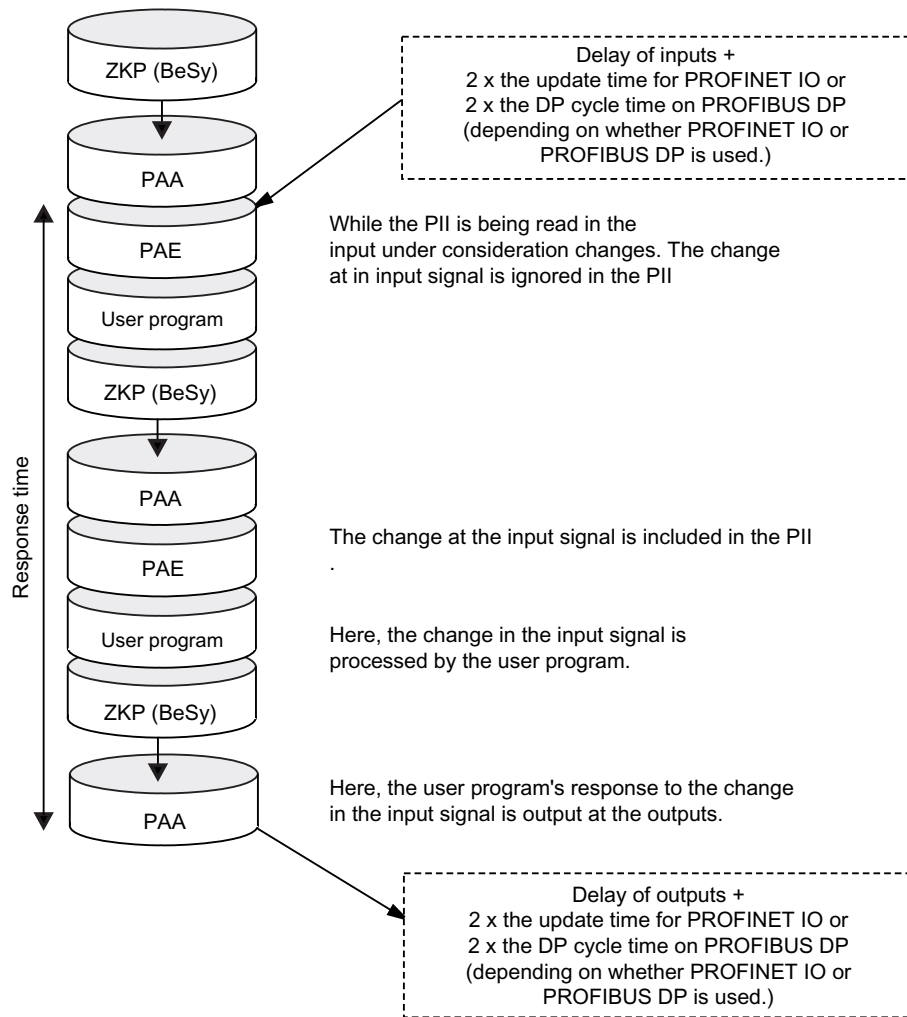

Calculation

The (longest) response time is the sum of:

Table 5- 11 Formula: Longest response time

	2 x process image transfer time for the inputs
+	2 x process image transfer time for the outputs
+	2 x program processing time
+	2 x operating system processing time
+	4 x PROFINET IO update time (only if PROFINET IO is used.)
+	4 x DP cycle time on PROFIBUS DP (only if PROFIBUS DP is used.)
+	I/O delay
=	Longest response time

Equivalent to the sum of 2 x the cycle time + I/O delay time + 4 x times the PROFINET IO update time or 4 x times the DP cycle time on PROFIBUS DP

See also

Overview (Page 137)

5.3.4 Reducing the response time with direct I/O access

Reducing the response time

You can reach faster response times with direct access to the I/O in your user program, e.g. with

- L PIB or
- T PQW

you can partially avoid the response times described above.

Note

You can also achieve fast response times by using process interrupts.

See also

Shortest response time (Page 139)

Longest response time (Page 140)

5.4 Calculating method for calculating the cycle/response time

Introduction

This section gives you an overview of how to calculate the cycle/response time.

Cycle time

1. Determine the user program runtime with the help of the *Instruction list*.
2. Multiply the calculated value by the CPU-specific factor from the table *Extension of user program processing time*.
3. Calculate and add the process image transfer time. Corresponding guide values are found in table *Data for calculating process image transfer time*.
4. Add the processing time at the scan cycle checkpoint. Corresponding guide values are found in the table *Operating system processing time at the scan cycle checkpoint*.
5. Include the extensions as a result of testing and commissioning functions as well as cyclical PROFINET interconnections in your calculation. These values are found in the table *Cycle time extension due to testing and commissioning functions*.

The final result is the **cycle time**.

Extension of the cycle time as a result of interrupts and communication load

1. Multiply the cycle time by the following factor:
$$100 / (100 - \text{configured communication load in \%})$$
2. Calculate the runtime of interrupt processing program sections with the help of the instruction list. Add the corresponding value from the table below.
3. Multiply both values by the CPU-specific extension factor of the user program processing time.
4. Add the value of the interrupt-processing program sequences to the theoretical cycle time, multiplied by the number of triggering (or expected) interrupt events within the cycle time.

The result is an approximation of the **physical cycle time**. Note down the result.

See also

Cycle extension through Component Based Automation (CBA) (Page 134)

Response time

Table 5- 12 Calculating the response time

Shortest response time	Longest response time
-	Multiply the physical cycle time by factor 2.
Now add I/O delay.	Now add the I/O delay plus the DP cycle times on PROFIBUS-DP or the PROFINET IO update times.
The result is the shortest response time.	The result is the longest response time.

See also

Longest response time (Page 140)

Shortest response time (Page 139)

Calculating the cycle time (Page 127)

Cycle extension through Component Based Automation (CBA) (Page 134)

5.5 Interrupt response time

5.5.1 Overview

Definition of interrupt response time

The interrupt response time is the time that expires between the first occurrence of an interrupt signal and the call of the first interrupt OB instruction. Generally valid: Higher-priority interrupts take priority. This means that the interrupt response time is increased by the program processing time of the higher-priority interrupt OBs and the interrupt OBs of equal priority which have not yet been executed (queued).

Process/diagnostic interrupt response times of the CPUs

Table 5- 13 Process and diagnostic interrupt response times

CPU	Process interrupt response times			Diagnostic interrupt response times	
	External min.	External max.	Integrated I/O max.	Min.	Max.
CPU 312	0.5 ms	0.8 ms	-	0.5 ms	1.0 ms
CPU 312C	0.5 ms	0.8 ms	0.6 ms	0.5 ms	1,0 ms
CPU 313C	0.4 ms	0.6 ms	0.5 ms	0.4 ms	1.0 ms
CPU 313C-2	0.4 ms	0,7 ms	0.5 ms	0.4 ms	1.0 ms
CPU 314	0.4 ms	0.7 ms	-	0.4 ms	1.0 ms
CPU 314C-2	0.4 ms	0.7 ms	0.5 ms	0.4 ms	1.0 ms
CPU 315-2 DP CPU 315-2 PN/DP	0.4 ms	0.7 ms	-	0.4 ms	1.0 ms
CPU 317-2 DP CPU 317-2 PN/DP	0.2 ms	0.3 ms	-	0.2 ms	0.3 ms
CPU 319-3 PN/DP	0.06 ms	0.10 ms	-	0.09 ms	0.12 ms

Calculation

The formula below show how you can calculate the minimum and maximum interrupt response times.

Table 5- 14 Process and diagnostic interrupt response times

Calculation of the minimum and maximum interrupt reaction time	
Minimum interrupt reaction time of the CPU + Minimum interrupt reaction time of the signal modules + PROFINET IO update time (only if PROFINET IO is used.) + DP cycle time on PROFIBUS DP (only if PROFIBUS DP is used.) = Quickest interrupt reaction time	Maximum interrupt reaction time of the CPU + Maximum interrupt reaction time of the signal modules + 2 x PROFINET IO update time (only if PROFINET IO is used.) + 2 x DP cycle time on PROFIBUS DP (only if PROFIBUS DP is used.) The maximum interrupt reaction time is longer when the communication functions are active. The extra time is calculated using the following formula: tv: 200 µs + 1000 µs x n% n = Setting of the cycle load as a result of communication

Signal modules

The **process interrupt response time** of signal modules is determined by the following factors:

- Digital input modules

Process interrupt response time = internal interrupt preparation time + input delay

You will find these times in the data sheet for the respective digital input module.

- Analog input modules

Process interrupt response time = internal interrupt preparation time + input delay

The internal interrupt preparation time for analog input modules can be neglected. The conversion times can be found in the data sheet for the individual analog input modules.

The **diagnostic interrupt response time** of signal modules is equivalent to the period that expires between the time a signal module detects a diagnostic event and the time this signal module triggers the diagnostic interrupt. This short time can be neglected.

Process interrupt processing

Process interrupt processing begins after process interrupt OB40 is called. Higher-priority interrupts stop process interrupt processing. Direct I/O access is executed during runtime of the instruction. After process interrupt processing has terminated, cyclic program execution continues or further interrupt OBs of equal or lower priority are called and processed.

See also

Overview (Page 123)

5.5.2 Reproducibility of Time-Delay and Watchdog Interrupts

Definition of "Reproducibility"

Delay interrupt:

The period that expires between the call of the first instruction in the interrupt OB and the programmed time of interrupt.

Watchdog interrupt:

The fluctuation width of the interval between two successive calls, measured between the respective initial instructions of the interrupt OBs.

Reproducibility

The following times apply for the CPUs described in this manual, with the exception of CPU 319

- Delay interrupt: +/- 200 μ s
- Watchdog interrupt: +/- 200 μ s

The following times apply in the case of CPU 319:

- Delay interrupt: +/- 140 μ s
- Watchdog interrupt: +/- 88 μ s

These times only apply if the interrupt can actually be executed at this time and if not interrupted, for example, by higher-priority interrupts or queued interrupts of equal priority.

5.6 Sample calculations

5.6.1 Example of cycle time calculation

Design

You have configured an S7300 and equipped it with following modules in rack "0":

- a CPU 314C-2
- 2 digital input modules SM 321; DI 32 x 24 VDC (4 bytes each in the PI)
- 2 digital output modules SM 322; DO 32 x 24 VDC/0.5 A (4 bytes each in the PI)

User Program

According to the Instruction List, the user program runtime is 5 ms. There is no active communication.

Calculating the cycle time

The cycle time for the example results from the following times:

- User program execution time:
approx. 5 ms x CPU-specific factor 1.10 = approx. 5.5 ms
- Process image transfer time
Process image of inputs: $100 \mu\text{s} + 8 \text{ Byte} \times 37 \mu\text{s} = \text{approx. } 0.4 \text{ ms}$
Process image of outputs: $100 \mu\text{s} + 8 \text{ Byte} \times 37 \mu\text{s} = \text{approx. } 0.4 \text{ ms}$
- Operating system runtime at scan cycle checkpoint:
Approx. 0.5 ms

Cycle time = 5.5 ms + 0.4 ms + 0.4 ms + 0.5 ms = 6.8 ms.

Calculation of the actual cycle time

- There is no active communication.
- There is no interrupt handling.

Hence, the **physical cycle time** is 6 ms.

Calculating the longest response time

Longest response time:

$$6.8 \text{ ms} \times 2 = 13.6 \text{ ms.}$$

- I/O delay can be neglected.
- Neither PROFIBUS DP, nor PROFINET IO are being used, so you do not have to make allowances for any DP cycle times on PROFIBUS DP or for PROFINET IO update times.
- There is no interrupt handling.

5.6.2 Sample of response time calculation

Design

You have configured an S7300 and equipped it with the following modules in two racks:

- a CPU 314C-2
Configuring the cycle load as a result of communication: 40 %
- 4 digital input modules SM 321; DI 32 x 24 VDC (4 bytes each in the PI)
- 3 digital output modules SM 322; DO 16 x 24 VDC/0.5 A (2 bytes each in the PI)
- 2 analog input modules SM 331; AI 8 x 12-bit (not in the PI)
- 2 analog output modules SM 332; AO 4 x 12 bit (not in the PI)

User Program

According to the instruction list, the user program runtime is 10.0 ms.

Calculating the cycle time

The cycle time for the example results from the following times:

- User program execution time:
approx. 10 ms x CPU-specific factor 1.10 = approx. 11 ms
- Process image transfer time
Process image of inputs: $100 \mu\text{s} + 16 \text{ bytes} \times 37 \mu\text{s} = \text{approx. } 0.7 \text{ ms}$
Process image of outputs: $100 \mu\text{s} + 6 \text{ bytes} \times 37 \mu\text{s} = \text{approx. } 0.3 \text{ ms}$
- Operating system runtime at scan cycle checkpoint:
Approx. 0.5 ms

The sum of the listed times is equivalent to the cycle time:

$$\text{Cycle time} = 11.0 \text{ ms} + 0.7 \text{ ms} + 0.3 \text{ ms} + 0.5 \text{ ms} = 12.5 \text{ ms.}$$

Calculation of the actual cycle time

Under consideration of communication load:

$$12.5 \text{ ms} \times 100 / (100-40) = 20.8 \text{ ms.}$$

Thus, under consideration of time-sharing factors, the **actual cycle time** is **21 ms**.

Calculation of the longest response time

- Longest response time = 21 ms x 2 = 42 ms.
- I/O delay
 - The maximum delay of the input digital module SM 321; DI 32 x 24 VDC is **4.8 ms** per channel.
 - The output delay of the digital output module SM 322; DO 16 x 24 VDC/0.5 A **can be neglected**.
 - The analog input module SM 331; AI 8 x 12 bit was configured for an interference suppression at 50 Hz. The result is a conversion time of 22 ms per channel. With the eight active channels, the result is a cycle time of **176 ms** for the analog input module.
 - The analog output module SM 332; AO 4 x 12-bit was programmed for the measuring range of 0 ... 10 V. This gives a conversion time of 0.8 ms per channel. Since 4 channels are active, the result is a cycle time of 3.2 ms. A settling time of 0.1 ms for a resistive load must be added to this value. The result is a response time of **3.3 ms** for an analog output.
- Neither PROFIBUS DP, nor PROFINET IO are being used, so you do not have to make allowances for any DP cycle times on PROFIBUS DP or for PROFINET IO update times.
- Response times plus I/O delay:
 - **Case 1:** An output channel of the digital output module is set when a signal is received at the digital input. The result is a response time of:
Response time = 42 ms + 4.8 ms = 46.8 ms.
 - **Case 2:** An analog value is fetched, and an analog value is output. The result is a response time of:
Longest response time = 42 ms + 176 ms + 3.3 ms = 221.3 ms.

5.6.3 Example of interrupt response time calculation

Design

You have assembled an S7-300, consisting of one CPU 314C-2 and four digital modules in the CPU rack. One of the digital input modules is an SM 321; DI 16 x 24 VDC; with process/diagnostic interrupt function.

You have enabled only the process interrupt in your CPU and SM parameter configuration. You decided not to use time-controlled processing, diagnostics or error handling. You have configured a 20% communication load on the cycle.

You have configured a delay of 0.5 ms for the inputs of the DI module.

No activities are required at the scan cycle checkpoint.

Calculation

In this example, the process interrupt response time is based on following time factors:

- Process interrupt response time of CPU 314C-2: Approx. 0.7 ms
- Extension by communication according to the formula:
 $200 \mu\text{s} + 1000 \mu\text{s} \times 20 \% = 400 \mu\text{s} = 0.4 \text{ ms}$
- Process interrupt response time of SM 321; DI 16 x 24 VDC:
 - Internal interrupt preparation time: 0.25 ms
 - Input delay: 0.5 ms
- Neither PROFIBUS DP, nor PROFINET IO are being used, so you do not have to make allowances for any DP cycle times on PROFIBUS DP or for PROFINET IO update times.

The process interrupt response time is equivalent to the sum of the listed time factors:

Process interrupt response time = 0.7 ms + 0.4 ms + 0.25 ms + 0.5 ms = approx. 1.85 ms.

This calculated process interrupt response time expires between the time a signal is received at the digital input and the call of the first instruction in OB40.

General technical data

6.1 Standards and approvals

Introduction

Contents of general technical data:

- standards and test values satisfied by modules of the S7-300 automation system
- test criteria of S7-300 modules.

CE Label



The S7-300 automation system satisfies requirements and safety-related objectives according to EC Directives listed below, and conforms with the harmonized European standards (EN) for programmable controllers announced in the Official Journals of the European Community:

- 2006/95/EC "Electrical Equipment Designed for Use within Certain Voltage Limits" (Low-Voltage Directive)
- 2004/108/EC "Electromagnetic Compatibility" (EMC Directive)
- 94/9/EC "Equipment and protective systems intended for use in potentially explosive atmospheres" (Explosion Protection Directive)

The EC declaration of conformity is held on file available to competent authorities at:

Siemens Aktiengesellschaft
Automation & Drives
A&D AS RD ST PLC
PO Box 1963
D-92209 Amberg

UL approval



Underwriters Laboratories Inc. complying with

- UL 508 (Industrial Control Equipment)

CSA approval



Canadian Standards Association to

- C22.2 No. 142 (Process Control Equipment)

or



Underwriters Laboratories Inc. complying with

- UL 508 (Industrial Control Equipment)
- CSA C22.2 No. 142 (Process Control Equipment)

or



HAZ. LOC.

Underwriters Laboratories Inc. complying with

- UL 508 (Industrial Control Equipment)
- CSA C22.2 No. 142 (Process Control Equipment)
- UL 1604 (Hazardous Location)
- CSA-213 (Hazardous Location)

APPROVED for use in
Class I, Division 2, Group A, B, C, D Tx;
Class I, Zone 2, Group IIC Tx

Note

Currently valid approvals can be found on the rating plate of the relevant module.

FM approval



Factory Mutual Research (FM) to
Approval Standard Class Number 3611, 3600, 3810
APPROVED for use in Class I, Division 2, Group A, B, C, D Tx;
Class I, Zone 2, Group IIC Tx

ATEX approval



to EN 60079-15:2003 (Electrical apparatus for potentially explosive atmospheres; Type of protection "n")



II 3 G Ex nA II Parts 4 to 6

WARNING

Personal injury and property damage can occur.

In potentially explosive environments, there is a risk of injury or damage if you disconnect any connectors while the S7-300 is in operation.

Always isolate the S7-300 operated in such areas before you disconnect and connectors.

WARNING

Explosion hazard

Components may no longer qualify for Class I, DIV. 2 if they are replaced.

WARNING

This device is only appropriate for use in Class I, Div. 2, Group A, B, C, D, or in non-hazardous areas.

Tick-mark for Australia



The S7-300 automation system satisfies requirements of standards to
AS/NZS 2064 (Class A).

IEC 61131

The S7-300 automation system satisfies requirements and criteria to IEC 61131-2 (Programmable Controllers, Part 2: Equipment requirements and tests).

Marine approval

Classification societies:

- ABS (American Bureau of Shipping)
- BV (Bureau Veritas)
- DNV (Det Norske Veritas)
- GL (Germanischer Lloyd)
- LRS (Lloyds Register of Shipping)
- Class NK (Nippon Kaiji Kyokai)

Use in industrial environments

SIMATIC products are designed for industrial applications.

Table 6- 1 Use in industrial environments

Field of application	Noise emission requirements	Noise immunity requirements
Industry	EN 61000-6-4: 2001	EN 61000-6-2: 2001

Use in residential areas

To operate an S7-300 in a residential area, it's RF emission must comply with Limit Value Class B to EN 55011.

The following measures are recommended to ensure the interference complies with limit value class B:

- S7-300 installation in grounded switch cabinets / cubicles
- Use of noise filters in the supply lines

 WARNING
Personal injury and damage to property may occur. In potentially explosive environments, there is a risk of injury or damage if you disconnect any connectors while the S7-300 is in operation. Always isolate the S7-300 operated in such areas before you disconnect and connectors.

6.2 Electromagnetic compatibility

Definition

Electromagnetic compatibility (EMC) is the ability of an electrical installation to function satisfactorily in its electromagnetic environment without interfering with that environment.

The S7-300 modules also satisfy requirements of EMC legislation for the European domestic market. Compliance of the S7-300 system with specifications and directives on electric design is prerequisite.

Pulseshaped disturbance

The table below shows the EMC compatibility of S7 modules in areas subject to pulse-shaped disturbance.

Pulse-shaped disturbance	Test voltage	corresponds with degree of severity
Electrostatic discharge to IEC 61000-4-2	Air discharge: ± 8 kV	3
	Contact discharge ± 4 kV	2
Burst pulses (high-speed transient disturbance) to IEC 61000-4-4.	2 kV (power supply lines)	3
	2 kV (signal lines > 3 m)	3
	1 kV (signal lines < 3 m)	
High-energy single pulse (surge) to IEC 61000-4-5 External protective circuit required (refer to <i>S7-300 Automation System, Hardware and Installation</i> , Chapter "Lightning and overvoltage protection")		3
• asymmetric coupling	2 kV (power supply lines) DC with protective elements 2 kV (signal/ data line only > 3 m), with protective elements as required	
• symmetric coupling	1 kV (power supply lines) DC with protective elements 1 kV (signal/ data line only > 3 m), with protective elements as required	

Additional measures

When connecting an S7-300 system to the public network, always ensure compliance with Limit Value Class B to EN 55022.

Sinusoidal disturbance

The table below shows the EMC compatibility of S7-300 modules in areas subject to sinusoidal disturbance.

Sinusoidal disturbance	Test values	corresponds with degree of severity
RF radiation (electromagnetic fields) to IEC 61000-4-3	10 V/m, with 80% amplitude modulation of 1 kHz in the 80 MHz to 1000 MHz range 10 V/m, with 50% pulse modulation at 900 MHz	3
RF conductance on cables and cable shielding to IEC 61000-4-6	Test voltage 10 V, with 80% amplitude modulation of 1 kHz in the 9 MHz to 80 MHz range	3

Emission of radio interference

Electromagnetic interference to EN 55011: Limit Class A, Group 1 (measured at a distance of 10 m.)

Frequency	Noise emission
30 MHz to 230 MHz	< 40 dB (µV/m)Q
230 MHz to 1000 MHz	< 47 dB (µV/m)Q

Noise emission via AC mains to EN 55011: Limit value class A, Group 1.

Frequency	Noise emission
0.15 MHz to 0.5 MHz	< 79 dB (µV/m)Q < 66 dB (µV/m)M
0.5 MHz to 5 MHz	< 73 dB (µV/m)Q < 60 dB (µV/m)M
5 MHz to 30 MHz	< 73 dB (µV/m)Q < 60 dB (µV/m)M

6.3 Transportation and storage conditions for modules

Introduction

The shipping and storage conditions of S7-300 modules surpass requirements to IEC 61131-2. The data below apply to modules shipped or put on shelf in their original packing.

The modules are compliant with climatic conditions to IEC 60721-3-3, Class 3K7 (storage), and with IEC 60721-3-2, Class 2K4 (shipping.)

Mechanical conditions are compliant with IEC 60721-3-2, Class 2M2.

Shipping and storage conditions for modules

Type of condition	Permissible range
Free fall (in shipping package)	≤ 1 m
Temperature	- 40 °C to + 70 °C
Barometric pressure	1080 hPa to 660 hPa (corresponds with an altitude of -1000 m to 3500 m)
Relative humidity	10% to 95%, no condensation
Sinusoidal oscillation to IEC 60068-2-6	5 Hz to 9 Hz: 3.5 mm 9 Hz to 150 Hz: 9.8 m/s ²
Shock to IEC 60068-2-29	250 m/s ² , 6 ms, 1000 shocks

6.4 Mechanical and climatic environmental conditions for S7-300 operation

Operating conditions

S7-300 systems are designed for stationary use in weather-proof locations. The operating conditions surpass requirements to DIN IEC 60721-3-3.

- Class 3M3 (mechanical requirements)
- Class 3K3 (climatic requirements)

Use with additional measures

The S7-300 may not be used under the conditions outlined below without taking additional measures:

- at locations with a high degree of ionizing radiation
- in aggressive environments caused, for example, by
 - the development of dust
 - corrosive vapors or gases
 - strong electric or magnetic fields
- in installations requiring special monitoring, for example
 - elevators
 - electrical plants in potentially hazardous areas

An additional measure could be an installation of the S7-300 in a cabinet or housing.

Mechanical environmental conditions

The table below shows the mechanical environmental conditions in the form of sinusoidal oscillations.

Frequency band	Continuous	Infrequently
10 Hz ≤ f ≤ 58 Hz	0.0375 mm amplitude	0.75 mm amplitude
58 Hz ≤ f ≤ 150 Hz	0.5 g constant acceleration	1 g constant acceleration

Reducing vibrations

If your S7-300 modules are exposed to severe shock or vibration, take appropriate measures to reduce acceleration or the amplitude.

We recommend the installation of the S7-300 on damping materials (for example, rubber-bonded-to-metal mounting.)

Test of mechanical environmental conditions

The table below provides important information with respect to the type and scope of the test of ambient mechanical conditions.

Condition tested	Test Standard	Comment
Vibration	Vibration test to IEC 60068-2-6 (sinusoidal)	Type of oscillation: Frequency sweeps with a rate of change of 1 octave/minute. 10 Hz \leq f \leq 58 Hz, constant amplitude 0.075 mm 58 Hz \leq f \leq 150 Hz, constant acceleration 1 g Duration of oscillation: 10 frequency sweeps per axis at each of three vertically aligned axes
Shock	Shock, tested to IEC 60068-2-27	Type of shock: half-sine Severity of shock: 15 g peak value, 11 ms duration Direction of shock: 3 shocks in each direction (+/-) at each of three vertically aligned axes
Continuous shock	Shock, tested to IEC 60068-2-29	Type of shock: Half-sine Shock intensity: 25 g peak value, 6 ms duration Shock direction: 1000 shocks in each direction (+/-) at each of three vertically aligned axes

Climatic environmental conditions

The S7-300 may be operated on following environmental conditions:

Environmental conditions	Permissible range	Comments
Temperature: horizontal mounting position: vertical mounting position:	0°C to 60°C 0°C to 40°C	-
Relative humidity	10 % to 95 %	No condensation, corresponds to relative humidity (RH) Class 2 to IEC 61131, Part 2
Barometric pressure	1080 hPa to 795 hPa	Corresponds with an altitude of -1000 m to 2000 m
Concentration of pollutants	SO ₂ : < 0.5 ppm; RH < 60 %, no condensation H ₂ S: < 0.1 ppm; RH < 60 %, no condensation	Test: 10 ppm; 4 days Test: 1 ppm; 4 days
	ISA-S71.04 severity level G1; G2; G3	-

6.5 Specification of dielectric tests, protection class, degree of protection, and rated voltage of S7-300

Test voltage

Proof of dielectric strength must be provided in the type test at a test voltage to IEC 61131-2:

Circuits with rated voltage V_n to other circuits or ground.	Test voltage
< 50 V	500 VDC
< 150 V	2500 VDC
< 250 V	4000 VDC

Protection class

Protection class I to IEC 60536, i.e., a protective conductor must be connected to the mounting rail!

Protection against the ingress of foreign matter and water

- Degree of protection IP 20 to IEC 60529, i.e., protection against contact with standard probes.

No protection against the ingress of water.

6.6 Rated voltages of S7-300

Rated operating voltages

The S7-300 modules operate at different rated voltages. The table shows the rated voltages and corresponding tolerances.

Rated voltages	Tolerance
24 VDC	20.4 VDC to 28.8 VDC
120 VAC	93 VAC to 132 VAC
230 VAC	187 VAC to 264 VAC

Technical data of CPU 31xC

7.1 General technical data

7.1.1 Dimensions of CPU 31xC

Each CPU features the same height and depth, only the width dimensions differ.

- Height: 125 mm
- Depth: 115 mm, or 180 mm with opened front cover.

Width of CPU

CPU	Width
CPU 312C	80 mm
CPU 313C	120 mm
CPU 313C-2 PtP	120 mm
CPU 313C-2 DP	120 mm
CPU 314C-2 PtP	120 mm
CPU 314C-2 DP	120 mm

7.1.2 Technical data of the Micro Memory Card

Plug-in SIMATIC Micro Memory Cards

The following memory modules are available:

Table 7- 1 Available SIMATIC Micro Memory Cards

Type			Order number	Required for a firmware update via SIMATIC Micro Memory Card
Micro Memory Card	64	Kbyte	6ES7953-8LFxx-0AA0	–
Micro Memory Card	128	Kbyte	6ES7953-8LGxx-0AA0	–
Micro Memory Card	512	Kbyte	6ES7953-8LJxx-0AA0	–
Micro Memory Card	2	MB	6ES7953-8LLxx-0AA0	Minimum requirement for CPUs without DP interface
Micro Memory Card	4	MB	6ES7953-8LMxx-0AA0	Minimum requirement for CPUs without DP interface (except CPU 319)
Micro Memory Card	8	MB ¹	6ES7953-8LPxx-0AA0	Minimum requirements for the CPU 319

¹ If you plug in the CPU 312C or CPU 312, you cannot use this SIMATIC Micro Memory Card.

Maximum number of loadable blocks on the SIMATIC Micro Memory Card

Number of blocks that can be stored on the SIMATIC Micro Memory Card depends on the capacity of the SIMATIC Micro Memory Card being used. The maximum number of blocks that can be loaded is therefore limited by the capacity of your SIMATIC Micro Memory Card (including blocks generated with the "CREATE DB" SFC)

Table 7- 2 Maximum number of loadable blocks on the SIMATIC Micro Memory Card

Size of SIMATIC Micro Memory Card		... Maximum number of blocks that can be loaded
64	Kbyte	768
128	Kbyte	1024
512	Kbyte	Here the maximum number of blocks that can be loaded for the specific CPU is less than the number of blocks that can be stored on the SIMATIC Micro Memory Card.
2	MB	
4	MB	
8	MB	Refer to the corresponding specifications of a specific CPU to determine the maximum number of blocks that can be loaded.

7.2 CPU 312C

Technical data

Table 7- 3 Technical data of CPU 312C

Technical data	
CPU and version	
Order no. [MLFB]	6ES7 312-5BE03-0AB0
• Hardware version	01
• Firmware version	V2.6
• Associated programming package	STEP 7 V5.4 + SP3 and higher, or STEP 7 V5.3 + SP2 and higher with HSP 0123
Memory	
Work memory	
• Integrated	32 KB
• Expandable	No
Load memory	Pluggable by means of Micro Memory Card (max. 4 MB)
Data storage life on the Micro Memory Card (following final programming)	At least 10 years
Buffering	Guaranteed by Micro Memory Card (maintenance-free)
Execution times	
Processing times of	
• Bit operations	Min. 0.2 μ s
• Word instructions	Min. 0.4 μ s
• Fixed-point arithmetic	Min. 5 μ s
• Floating-point arithmetic	Min. 6 μ s
Timers/counters and their retentive address areas	
S7 counters	128
• Retentivity	Configurable
• Default	From C 0 to C 7
• Counting range	0 to 999
IEC Counters	Yes
• Type	SFB
• Number	Unlimited (limited only by work memory size)
S7 timers	128
• Retentivity	Configurable
• Default	Not retentive
• Timer range	10 ms to 9990 s

Technical data	
IEC timers	Yes
• Type	SFB
• Number	Unlimited (limited only by work memory size)
Data areas and their retentive address areas	
Bit memory	128 bytes
• Retentivity	Configurable
• Preset retentive address areas	MB0 to MB15
Clock flag bits	8 (1 memory byte)
Data blocks	Max. 511 (in the 1 to 511 range of numbers)
• Size	Max. 16 KB
• Non-retain support (configurable retentivity)	Yes
Local data per priority class	Max. 256 bytes
Blocks	
Total	1024 (DBs, FCs, FBs) The maximum number of blocks that can be loaded may be reduced if you are using another Micro Memory Card.
OBs	See the Instruction List
• Size	Max. 16 KB
• Number of free-cycle OBs	1 (OB 1)
• Number of time-of-day interrupt OBs	1 (OB 10)
• Number of time-delay interrupt OBs	1 (OB 20)
• Number of watchdog interrupts	1 (OB 35)
• Number of process interrupt OBs	1 (OB 40)
• Number of startup OBs	1 (OB 100)
• Number of asynchronous error OBs	4 (OB 80, 82, 85, 87)
• Number of synchronous error OBs	2 (OB 121, 122)
Nesting depth	
• Per priority class	8
• Additional within an error OB	4
FBs	
• Number, max.	1024 (in the 0 to 2047 range of numbers)
• Size	Max. 16 KB
FCs	
• Number, max.	1024 (in the 0 to 2047 range of numbers)
• Size	Max. 16 KB

Technical data	
Address areas (I/O)	
Total I/O address area	
• Inputs	1024 bytes (user-specific addressing)
• Outputs	1024 bytes (user-specific addressing)
I/O process image	
• Inputs	128 bytes
• Outputs	128 bytes
Digital channels	
• Integrated channels (DI)	10
• Integrated channels (DO)	6
• Inputs	266
• Outputs	262
• Inputs, central	266
• Outputs, central	262
Analog channels	
• Integrated channels (AI)	None
• Integrated channels (AO)	None
• Inputs	64
• Outputs	64
• Inputs, central	64
• Outputs, central	64
Removal	
Racks	Max. 1
Modules per rack	Max. 8
Number of DP masters	
• Integrated	None
• Via CP	4
Operable function modules and communication processors	
• FM	Max. 8
• CP (PtP)	Max. 8
• CP (LAN)	Max. 4
Time	
Clock	Yes (SW clock)
• Buffered	No
• Accuracy	Deviation per day < 15 s
• Behavior of the realtime clock after POWER ON	The clock keeps running, continuing at the time-of-day it had when power was switched off.

Technical data	
Operating hours counter	1
• Number	0
• Value range	2 ³¹ hours (if SFC 101 is used)
• Granularity	1 hour
• Retentive	Yes; must be manually restarted after every restart
Clock synchronization	Yes
• In the AS	Master
• On MPI	Master/slave
S7 message functions	
Number of stations that can be logged on for signaling functions	Max. 6 (depends on the number of connections configured for PG / OP and S7 basic communication)
Process diagnostics messages	Yes
• Simultaneously enabled interrupt S blocks	Max. 20
Test and startup functions	
Status/control variables	Yes
• Variable	Inputs, outputs, memory bits, DBs, timers, counters
• Number of variables	Max. 30
– Of those as status variable	Max. 30
– Of those as control variable	Max. 14
Force	Yes
• Variable	Inputs, outputs
• Number of variables	Max. 10
Block status	Yes
Single-step	Yes
Breakpoint	2
Diagnostics buffer	Yes
• Number of entries (not configurable)	Max. 100
Communication functions	
PG/OP communication	Yes
Global data communication	Yes
• Number of GD circuits	4
• Number of GD packets	Max. 4
– Sending stations	Max. 4
– Receiving stations	Max. 4
• Length of GD packets	Max. 22 bytes
– Consistent data	22 bytes

Technical data	
S7 basic communication	Yes
<ul style="list-style-type: none"> • User data per job • Consistent data 	Max. 76 bytes 76 bytes (for X_SEND or X_RCV) 64 bytes (for X_PUT or X_GET as the server)
S7 communication	
<ul style="list-style-type: none"> • As server 	Yes
<ul style="list-style-type: none"> • User data per job <ul style="list-style-type: none"> – Consistent data 	Max. 180 bytes (with PUT/GET) 64 bytes
S5-compatible communication	Yes (via CP and loadable FCs)
Number of connections	Max. 6
Can be used for	
<ul style="list-style-type: none"> • PG communication <ul style="list-style-type: none"> – Reserved (default) – Configurable 	Max. 5 1 From 1 to 5
<ul style="list-style-type: none"> • OP communication <ul style="list-style-type: none"> – Reserved (default) – Configurable 	Max. 5 1 From 1 to 5
<ul style="list-style-type: none"> • S7-based communication <ul style="list-style-type: none"> – Reserved (default) – Configurable 	Max. 2 0 From 0 to 2
Routing	No
Interfaces	
1st interface	
Type of interface	Integrated RS485 interface
Physics	RS 485
Electrically isolated	No
Interface power supply (15 to 30 VDC)	Max. 200 mA
Functionality	
<ul style="list-style-type: none"> • MPI 	Yes
<ul style="list-style-type: none"> • PROFIBUS DP 	No
<ul style="list-style-type: none"> • Point-to-point connection 	No

Technical data	
MPI	
Services	
• PG/OP communication	Yes
• Routing	No
• Global data communication	Yes
• S7 basic communication	Yes
• S7 communication	
– As server	Yes
– As client	No
• Transmission rates	Max. 187.5 kbps
Programming	
Programming language	LAD/FBD/STL
Instruction set	See the Instruction List
Nesting levels	8
System functions (SFC)	See the Instruction List
System function blocks (SFB)	See the Instruction List
User program protection	Yes
Integrated I/O	
• Default addresses of the integrated	
– Digital inputs	124.0 to 125.1
– Digital outputs	124.0 to 124.5
Integrated functions	
Counters	2 channels (see the Manual <i>Technological Functions</i>)
Frequency counters	2 channels, max. 10 kHz (see the Manual <i>Technological Functions</i>)
Cycle duration measurement	2 channels (see the Manual <i>Technological Functions</i>)
Pulse outputs	2 channels for pulse width modulation, max. 2.5 kHz (see the Manual <i>Technological Functions</i>)
Controlled positioning	No
Integrated "Controlling" SFB	No
Dimensions	
Mounting dimensions W x H x D (mm)	80 x 125 x 130
Weight	409 g

Technical data	
Voltages and currents	
Power supply (rated value)	24 VDC
• Permissible range	20.4 V to 28.8 V
Current consumption (no-load operation)	Typically 60 mA
Inrush current	Typically 11 A
Power consumption (nominal value)	500 mA
I ² t	0.7 A ² s
External fusing of power supply lines (recommended)	LS switch Type C min. 2 A, LS switch Type B min. 4 A
Power loss	Typically 6 W

Reference

In Chapter *Specifications of the integrated I/O* you can find

- Under *Digital inputs of CPUs 31xC* and *Digital outputs of CPUs 31xC* the technical data of integrated I/Os.
- the block diagrams of the integrated I/Os under *Arrangement and usage of integrated I/Os*.

7.3 CPU 313C

Technical data

Table 7- 4 Technical data of CPU 313C

Technical data	
CPU and version	
Order no. [MLFB]	6ES7 313-5BF03-0AB0
• Hardware version	01
• Firmware version	V2.6
• Associated programming package	STEP 7 V5.4 + SP3 and higher, or STEP 7 V5.3 + SP2 and higher with HSP 0123
Memory	
Main memory	
• Integrated	64 KB
• Expandable	No
Load memory	Pluggable by means of Micro Memory Card (max. 8 MB)
Data storage life on the Micro Memory Card (following final programming)	At least 10 years
Buffering	Guaranteed by Micro Memory Card (maintenance-free)
Execution times	
Processing times of	
• Bit operations	Min. 0.1 µs
• Word instructions	Min. 0.2 µs
• Fixed-point arithmetic	Min. 2 µs
• Floating-point arithmetic	Min. 3 µs
Timers/counters and their retentive address areas	
S7 counters	256
• Retentivity	Configurable
• Default	From C 0 to C 7
• Counting range	0 to 999
IEC Counters	Yes
• Type	SFB
• Number	Unlimited (limited only by work memory size)
S7 timers	256
• Retentivity	Configurable
• Default	Not retentive
• Timer range	10 ms to 9990 s

Technical data	
IEC timers	Yes
• Type	SFB
• Number	Unlimited (limited only by work memory size)
Data areas and their retentive address areas	
Bit memory	256 bytes
• Retentivity	Configurable
• Preset retentive address areas	MB0 to MB15
Clock flag bits	8 (1 memory byte)
Data blocks	Max. 511 (in the 1 to 511 range of numbers)
• Size	Max. 16 KB
• Non-retain support (configurable retentivity)	Yes
Local data per priority class	Max. 510 bytes
Blocks	
Total	1024 (DBs, FCs, FBs) The maximum number of blocks that can be loaded may be reduced if you are using another Micro Memory Card.
OBs	See the Instruction List
• Size	Max. 16 KB
• Number of free-cycle OBs	1 (OB 1)
• Number of time-of-day interrupt OBs	1 (OB 10)
• Number of time-delay interrupt OBs	1 (OB 20)
• Number of watchdog interrupts	1 (OB 35)
• Number of process interrupt OBs	1 (OB 40)
• Number of startup OBs	1 (OB 100)
• Number of asynchronous error OBs	4 (OB 80, 82, 85, 87)
• Number of synchronous error OBs	2 (OB 121, 122)
Nesting depth	
• Per priority class	8
• Additional within an error OB	4
FBs	
• Number, max.	1024 (in the 0 to 2047 range of numbers)
• Size	Max. 16 KB
FCs	
• Number, max.	1024 (in the 0 to 2047 range of numbers)
• Size	Max. 16 KB

Technical data	
Address areas (I/O)	
Total I/O address area	
• Inputs	1024 bytes (user-specific addressing)
• Outputs	1024 bytes (user-specific addressing)
Process I/O image	
• Inputs	128 bytes
• Outputs	128 bytes
Digital channels	
• Integrated channels (DI)	24
• Integrated channels (DO)	16
• Inputs	1016
• Outputs	1008
• Inputs, central	1016
• Outputs, central	1008
Analog channels	
• Integrated channels (AI)	4+1
• Integrated channels (AO)	2
• Inputs	253
• Outputs	250
• Inputs, central	253
• Outputs, central	250
Removal	
Racks	Max. 4
Modules per rack	Max. 8; max. 7 in rack 3
Number of DP masters	
• Integrated	None
• Via CP	4
Operable function modules and communication processors	
• FM	Max. 8
• CP (PtP)	Max. 8
• CP (LAN)	Max. 6

Technical data	
Time	
Clock	Yes (HW clock)
• Buffered	Yes
• Buffered period	Typically 6 weeks (at an ambient temperature of 40 °C)
• Behavior of the clock on expiration of the buffered period	The clock keeps running, continuing at the time-of-day it had when power was switched off.
• Accuracy	Deviation per day < 10 s
Operating hours counter	1
• Number	0
• Range of values	2 ³¹ hours (if SFC 101 is used)
• Granularity	1 hour
• Retentive	Yes; must be manually restarted after every restart
Clock synchronization	Yes
• In the AS	Master
• On MPI	Master/slave
S7 message functions	
Number of stations that can be logged on for signaling functions	Max. 8 (depends on the number of connections configured for PG / OP and S7 basic communication)
Process diagnostics messages	Yes
• Simultaneously enabled interrupt S blocks	Max. 20
Test and startup functions	
Status/control variables	Yes
• Variable	Inputs, outputs, memory bits, DBs, timers, counters
• Number of variables	Max. 30
– of those as status variable	Max. 30
– of those as control variable	Max. 14
Force	Yes
• Variable	Inputs, outputs
• Number of variables	Max. 10
Block status	Yes
Single-step	Yes
Breakpoint	2
Diagnostics buffer	Yes
• Number of entries (not configurable)	Max. 100

Technical data	
Communication functions	
PG/OP communication	Yes
Global data communication	Yes
• Number of GD circuits	4
• Number of GD packets	Max. 4
– Sender	Max. 4
– Receiving stations	Max. 4
• Length of GD packets	Max. 22 bytes
– Consistent data	22 bytes
S7 basic communication	Yes
• User data per job	Max. 76 bytes
– Consistent data	76 bytes (for X_SEND or X_RCV) 64 bytes (for X_PUT or X_GET as the server)
S7 communication	
• As server	Yes
• As client	Yes (via CP and loadable FBs)
• User data per job	Max. 180 bytes (with PUT/GET)
– Consistent data	64 bytes
S5-compatible communication	Yes (via CP and loadable FCs)
Number of connections	Max. 8
Can be used for	
• PG communication	Max. 7
– Reserved (default)	1
– Configurable	From 1 to 7
• OP communication	Max. 7
– Reserved (default)	1
– Configurable	From 1 to 7
• S7 basic communication	Max. 4
– Reserved (default)	0
– Configurable	From 0 to 4
Routing	No
Interfaces	
1st interface	
Type of interface	Integrated RS485 interface
Physics	RS 485
Electrically isolated	No
Interface power supply (15 to 30 VDC)	Max. 200 mA
Functionality	
• MPI	Yes
• PROFIBUS DP	No
• PtP communication	No

Technical data	
MPI	
Services	
• PG/OP communication	Yes
• Routing	No
• Global data communication	Yes
• S7 basic communication	Yes
• S7 communication <ul style="list-style-type: none"> – As server – As client 	Yes No (but with CP and loadable FB)
• Transmission rates	Max. 187.5 kbps
Programming	
Programming language	LAD/FBD/STL
Instruction set	See the Instruction List
Nesting levels	8
System functions (SFC)	See the Instruction List
System function blocks (SFB)	See the Instruction List
User program protection	Yes
Integrated I/O	
• Default addresses of the integrated <ul style="list-style-type: none"> – Digital inputs – Digital outputs – Analog inputs – Analog outputs 	124.0 to 126.7 124.0 to 125.7 752 to 761 752 to 755
Integrated functions	
Counters	3 channels (see the Manual <i>Technological Functions</i>)
Frequency counters	3 channels up to max. 30 kHz (see the <i>Technological Functions</i> manual)
Cycle duration measurement	3 channels (see the Manual <i>Technological Functions</i>)
Pulse outputs	3 channels pulse-width modulation up to max. 2.5 kHz (see <i>Technological Functions</i> manual)
Controlled positioning	No
Integrated "Controlling" SFB	PID controller (see the manual <i>Technological Functions</i>)

Technical data	
Dimensions	
Mounting dimensions W x H x D (mm)	120 x 125 x 130
Weight	660 g
Voltages and currents	
Power supply (rated value)	24 VDC
• Permissible range	20.4 V to 28.8 V
Current consumption (no-load operation)	Typically 150 mA
Inrush current	Typically 11 A
Power consumption (nominal value)	700 mA
I ² t	0.7 A ² s
External fusing of power supply lines (recommended)	LS switch Type C min. 2 A, LS switch Type B min. 4 A,
Power loss	Typically 14 W

Reference

In Chapter *Specifications of the integrated I/O* you can find

- The specifications of integrated I/O under *Digital inputs of CPUs 31xC*, *Digital outputs of CPUs 31xC*, *Analog inputs of CPUs 31xC* and *Analog outputs of CPUs 31xC*.
- the block diagrams of the integrated I/Os under *Arrangement and usage of integrated I/Os*.

7.4 CPU 313C-2 PtP and CPU 313C-2 DP

Technical data

Table 7- 5 Technical data for CPU 313C-2 PtP/ CPU 313C-2 DP

Technical data		
	CPU 313C-2 PtP	CPU 313C-2 DP
CPU and version	CPU 313C-2 PtP	CPU 313C-2 DP
Order no. [MLFB]	6ES7 313-6BF03-0AB0	6ES7 313-6CF03-0AB0
• Hardware version	01	01
• Firmware version	V2.6	V2.6
Associated programming package	STEP 7 V5.4 + SP3 and higher, or STEP 7 V5.3 + SP2 and higher with HSP 0123	STEP 7 V5.4 + SP3 and higher, or STEP 7 V5.3 + SP2 and higher with HSP 0123
Memory	CPU 313C-2 PtP	CPU 313C-2 DP
Work memory		
• Integrated	64 Kbytes	
• Expandable	No	
Load memory	Pluggable by means of Micro Memory Card (max. 8 MB)	
Data storage life on the Micro Memory Card (following final programming)	At least 10 years	
Buffering	Guaranteed by Micro Memory Card (maintenance-free)	
Execution times	CPU 313C-2 PtP	CPU 313C-2 DP
Processing times of		
• Bit operations	min. 0.1 µs	
• Word instructions	min. 0.2 µs	
• Fixed-point arithmetic	min. 2 µs	
• Floating-point arithmetic	min. 3 µs	
Timers/counters and their retentive address areas	CPU 313C-2 PtP	CPU 313C-2 DP
S7 counters	256	
• Retentivity	Configurable	
• Default	From C 0 to C 7	
• Counting range	0 to 999	
IEC Counters	Yes	
• Type	SFB	
• Number	unlimited (limited only by work memory size)	

Technical data		
	CPU 313C-2 PtP	CPU 313C-2 DP
S7 timers	256	
• Retentivity	Configurable	
• default	Not retentive	
• Timer range	10 ms to 9990 s	
IEC timers	Yes	
• Type	SFB	
• Number	unlimited (limited only by work memory size)	
Data areas and their retentive address areas	CPU 313C-2 PtP	CPU 313C-2 DP
Bit memory	256 bytes	
• Retentivity	Configurable	
• Preset retentive address areas	MB0 to MB15	
Clock flag bits	8 (1 memory byte)	
Data blocks	Max. 511 (in the 1 to 511 range of numbers)	
• Size	max. 16 KB	
• Non-retain support (configurable retentive address areas)	Yes	
Local data per priority class	max. 510 bytes	
Blocks	CPU 313C-2 PtP	CPU 313C-2 DP
Total	1024 (DBs, FCs, FBs) The maximum number of blocks that can be loaded may be reduced if you are using another Micro Memory Card.	
OBs	see the Instruction List	
• Size	max. 16 KB	
• Number of free-cycle OBs	1 (OB 1)	
• Number of time-of-day interrupt OBs	1 (OB 10)	
• Number of time-delay interrupt OBs	1 (OB 20)	
• Number of watchdog interrupts	1 (OB 35)	
• Number of process interrupt OBs	1 (OB 40)	
• Number of DPV1 interrupt OBs	-	3 (OB 55, 56, 57)
• Number of startup OBs	1 (OB 100)	
• Number of asynchronous error OBs	4 (OB 80, 82, 85, 87)	5 (OB 80, 82, 85, 86, 87)
• Number of synchronous error OBs	2 (OB 121, 122)	
Nesting depth		
• Per priority class	8	
• Additional within an error OB	4	

Technical data		
	CPU 313C-2 PtP	CPU 313C-2 DP
FBs		
• Number, max.	1024 (in the 0 to 2047 range of numbers)	
• Size	max. 16 KB	
FCs		
• Number, max.	1024 (in the 0 to 2047 range of numbers)	
• Size	max. 16 KB	
Address areas (I/O)	CPU 313C-2 PtP	CPU 313C-2 DP
Total I/O address area		
• Inputs	1024 bytes (user-specific addressing)	1024 bytes (user-specific addressing)
• Outputs	1024 bytes (user-specific addressing)	1024 bytes (user-specific addressing)
• Distributed		
– Inputs	none	1006 bytes
– Outputs	none	1006 bytes
I/O process image		
• Inputs	128 bytes	128 bytes
• Outputs	128 bytes	128 bytes
Digital channels		
• Integrated channels (DI)	16	16
• Integrated channels (DO)	16	16
• Inputs	1008	8064
• Outputs	1008	8064
• Inputs, central	1008	1008
• Outputs, central	1008	1008
Analog channels		
• Integrated channels	None	None
• Integrated channels	None	None
• Inputs	248	503
• Outputs	248	503
• Inputs, central	248	248
• Outputs, central	248	248
Removal	CPU 313C-2 PtP	CPU 313C-2 DP
Racks	Max. 4	
Modules per rack	max. 8; max. 7 in rack 3	
Number of DP masters		
• Integrated	No	1
• Via CP	4	4

Technical data		
	CPU 313C-2 PtP	CPU 313C-2 DP
Operable function modules and communication processors		
• FM	Max. 8	
• CP (PtP)	Max. 8	
• CP (LAN)	Max. 6	
Time	CPU 313C-2 PtP	CPU 313C-2 DP
Clock	Yes (HW clock)	
• Buffered	Yes	
• Buffered period	Typically 6 weeks (at an ambient temperature of 40 °C)	
• Behavior of the clock on expiration of the buffered period	The clock keeps running, continuing at the time-of-day it had when power was switched off.	
• Accuracy	Deviation per day < 10 s	
Operating hours counter	1	
• Number	0	
• Range of values	2 ³¹ hours (if SFC 101 is used)	
• Granularity	1 hour	
• Retentive	Yes; must be manually restarted after every restart	
Clock synchronization	Yes	
• In the AS	Master	
• On MPI	Master/slave	
• On DP	-	Master/slave (only time slave if DP slave)
S7 message functions	CPU 313C-2 PtP	CPU 313C-2 DP
Number of stations that can log in for signaling functions (e.g. OS)	Max. 8 (depends on the number of connections configured for PG / OP and S7 basic communication)	
Process diagnostics messages	Yes	
• Simultaneously enabled interrupt S blocks	Max. 20	
Test and startup functions	CPU 313C-2 PtP	CPU 313C-2 DP
Status/control variables	Yes	
• Variable	Inputs, outputs, memory bits, DBs, timers, counters	
• Number of variables	Max. 30	
– Of those as status variable	Max. 30	
– Of those as control variable	Max. 14	
Force	Yes	
• Variable	Inputs, outputs	
• Number of variables	Max. 10	
Block status	Yes	

Technical data		
	CPU 313C-2 PtP	CPU 313C-2 DP
Single-step	Yes	
Breakpoint	2	
Diagnostics buffer	Yes	
• Number of entries (not configurable)	Max. 100	
Communication functions	CPU 313C-2 PtP	CPU 313C-2 DP
PG/OP communication	Yes	
Global Data Communication	Yes	
• Number of GD circuits	4	
• Number of GD packets	Max. 4	
– Sending stations	Max. 4	
– Receiving stations	Max. 4	
• Length of GD packets	max. 22 bytes	
– Consistent data	22 bytes	
S7 basic communication	Yes (server)	
• User data per job	max. 76 bytes	
– Consistent data	76 bytes (for X_SEND or X_RCV) 64 bytes (for X_PUT or X_GET as the server)	
S7 communication		
• As server	Yes	
• As client	Yes (via CP and loadable FBs)	
• User data per job	max. 180 bytes (with PUT/GET)	
– Consistent data	64 bytes	
S5-compatible communication	Yes (via CP and loadable FCs)	
Number of connections	Max. 8	
can be used for		
• PG communication	Max. 7	
– Reserved (default)	1	
– Configurable	from 1 to 7	
• OP communication	max. 7	
– Reserved (default)	1	
– Configurable	from 1 to 7	
• S7-based communication	Max. 4	
– Reserved (default)	0	
– Configurable	From 0 to 4	
Routing	No	Max. 4
Interfaces	CPU 313C-2 PtP	CPU 313C-2 DP
1st interface		
Type of interface	Integrated RS485 interface	
Physics	RS 485	
electrically isolated	No	
Interface power supply (15 to 30 VDC)	Max. 200 mA	

Technical data		
	CPU 313C-2 PtP	CPU 313C-2 DP
Functionality		
• MPI	Yes	
• PROFIBUS DP	No	
• Point-to-point connection	No	
MPI		
Services		
• PG/OP communication	Yes	
• Routing	No	Yes
• Global data communication	Yes	
• S7 basic communication	Yes	
• S7 communication – As server – As client	<ul style="list-style-type: none"> • Yes • No (but via CP and loadable FBs) 	
• Transmission rates	Max. 187.5 kbps	
2nd interface		
Type of interface	Integrated RS422/RS485 interface	Integrated RS485 interface
Physics	RS 422/485	RS 485
Electrically isolated	Yes	Yes
Interface power supply (15 to 30 VDC)	No	Max. 200 mA
Number of connections	None	8
Functionality		
• MPI	No	No
• PROFIBUS DP	No	Yes
• Point-to-point connection	Yes	No
DP master		
Number of connections	–	8
Services		
• PG/OP communication	–	Yes
• Routing	–	Yes
• Global data communication	–	No
• S7 basic communication	–	Yes (only I blocks)
• S7 communication	–	Yes (only server; configured unilateral connection)
• Constant bus cycle time	–	No
• Isochronous mode	–	No
• SYNC/FREEZE	–	Yes

Technical data		
	CPU 313C-2 PtP	CPU 313C-2 DP
<ul style="list-style-type: none"> • Activate/deactivate DP slaves <ul style="list-style-type: none"> – Max. number of DP slaves that can be activated/deactivated simultaneously 	–	Yes 4
<ul style="list-style-type: none"> • DPV1 	–	Yes
<ul style="list-style-type: none"> • Transmission rates 	–	Up to 12 Mbaud
<ul style="list-style-type: none"> • Number of DP slaves per station 	–	Max. 32
<ul style="list-style-type: none"> • Address area 	–	max. 1 KB I / 1 KB O
<ul style="list-style-type: none"> • User data per DP slave 	–	Max. 244 bytes I / 244 bytes O
DP slave		
Number of connections	–	8
Services		
<ul style="list-style-type: none"> • PG/OP communication 	–	Yes
<ul style="list-style-type: none"> • Routing 	–	Yes (only if interface is active)
<ul style="list-style-type: none"> • Global data communication 	–	No
<ul style="list-style-type: none"> • S7 basic communication 	–	No
<ul style="list-style-type: none"> • S7 communication 	–	Yes (only server; configured unilateral connection)
<ul style="list-style-type: none"> • Direct data exchange 	–	Yes
<ul style="list-style-type: none"> • Transmission rates 	–	Up to 12 Mbaud
<ul style="list-style-type: none"> • Automatic baud rate search 	–	Yes (only if interface is passive)
<ul style="list-style-type: none"> • Intermediate memory 	–	244 bytes I / 244 bytes O
<ul style="list-style-type: none"> • Address areas 	–	Max. 32, with max. 32 bytes each
<ul style="list-style-type: none"> • DPV1 	–	No
GSD file	–	The latest GSD file is available at: http://automation.siemens.com/csi/gsd
Point-to-point connection		
<ul style="list-style-type: none"> • Transmission rates 	38.4 Kbaud half duplex 19.2 Kbaud full duplex	–
<ul style="list-style-type: none"> • Cable length 	Max. 1200 m	–
<ul style="list-style-type: none"> • User program can control the interface 	Yes	–
<ul style="list-style-type: none"> • The interface can trigger a break or an interrupt in the user program 	Yes (message with break ID)	–
<ul style="list-style-type: none"> • Protocol driver 	3964(R); ASCII	–
Programming		
Programming language	LAD/FBD/STL	
Instruction set	see the Instruction List	
Nesting levels	8	
System functions (SFC)	see the Instruction List	

Technical data		
	CPU 313C-2 PtP	CPU 313C-2 DP
System function blocks (SFB)	see the Instruction List	
User program protection	Yes	
Integrated I/O	CPU 313C-2 PtP	CPU 313C-2 DP
<ul style="list-style-type: none"> • Default addresses of the integrated <ul style="list-style-type: none"> – Digital inputs – Digital outputs 	124.0 to 125.7	124.0 to 125.7
Integrated functions		
Counters	3 channels (see the <i>Technological Functions</i> manual)	
Frequency counters	3 channels up to max. 30 kHz (see the <i>Technological Functions</i> manual)	
Cycle duration measurement	3 channels (see the Manual <i>Technological Functions</i>)	
Pulse outputs	3 channels pulse-width modulation up to max. 2.5 kHz (see the manual <i>Technological Functions</i>)	
Controlled positioning	No	
Integrated "Controlling" SFB	PID controller (see the manual <i>Technological Functions</i>)	
Dimensions	CPU 313C-2 PtP	CPU 313C-2 DP
Mounting dimensions W x H x D (mm)	120 x 125 x 130	
Weight	approx. 566 g	
Voltagages and currents	CPU 313C-2 PtP	CPU 313C-2 DP
Power supply (rated value)	24 VDC	
<ul style="list-style-type: none"> • Permissible range 	20.4 V to 28.8 V	
Current consumption (no-load operation)	Typically 100 mA	
Inrush current	Typically. 11 A	
Power consumption (nominal value)	700 mA	900 mA
I ² t	0.7 A ² s	
External fusing of power supply lines (recommended)	LS switch type B: min. 4 A, type C: min. 2 A	
Power loss	Typically 10 W	

Reference

In Chapter *Specifications of the integrated I/O* you can find

- under *Digital inputs of CPUs 31xC* and *Digital outputs of CPUs 31xC* the technical data of integrated I/Os.
- the block diagrams of the integrated I/Os under *Arrangement and usage of integrated I/Os*.

7.5 CPU 314C-2 PtP and CPU 314C-2 DP

Technical Data

Table 7- 6 Technical data of CPU 314C-2 PtP and CPU 314C-2 DP

Technical data		
	CPU 314C-2 PtP	CPU 314C-2 DP
CPU and version	CPU 314C-2 PtP	CPU 314C-2 DP
Order no. [MLFB]	6ES7 314-6BG03-0AB0	6ES7 314-6CG03-0AB0
• Hardware version	01	01
• Firmware version	V2.6	V2.6
Associated programming package	STEP 7 V5.4 + SP3 and higher, or STEP 7 V5.3 + SP2 and higher with HSP 0123	STEP 7 V5.4 + SP3 and higher, or STEP 7 V5.3 + SP2 and higher with HSP 0123
Memory	CPU 314C-2 PtP	CPU 314C-2 DP
Work memory		
• Integrated	96 KB	
• Expandable	No	
• Capacity of retentive memory for retentive data blocks	64 KB	
Load memory	Pluggable by means of SIMATIC Micro Memory Card (max. 8 Mbytes)	
Data storage life on the MMC (following final programming)	At least 10 years	
Buffering	Guaranteed by SIMATIC MMC (maintenance-free)	
Execution times	CPU 314C-2 PtP	CPU 314C-2 DP
Processing times of		
• Bit operations	Min. 0.1 µs	
• Word instructions	Min. 0.2 µs	
• Fixed-point arithmetic	Min. 2 µs	
• Floating-point arithmetic	Min. 3 µs	
Timers/counters and their retentive address areas	CPU 314C-2 PtP	CPU 314C-2 DP
S7 counters	256	
• Retentivity	Configurable	
• Default	from C 0 to C 7	
• Counting range	0 to 999	
IEC Counters	Yes	
• Type	SFB	
• Number	unlimited (limited only by work memory size)	

Technical data		
	CPU 314C-2 PtP	CPU 314C-2 DP
S7 timers	256	
• Retentivity	Configurable	
• Default	Not retentive	
• Timer range	10 ms to 9990 s	
IEC timers	Yes	
• Type	SFB	
• Number	unlimited (limited only by work memory size)	
Data areas and their retentive address areas	CPU 314C-2 PtP	CPU 314C-2 DP
Bit memory	256 bytes	
• Retentivity	Configurable	
• Preset retentive address areas	MB0 to MB15	
Clock flag bits	8 (1 memory byte)	
Data blocks	Max. 511 (in the 1 to 511 range of numbers)	
• Size	max. 16 KB	
• Non-retain support (configurable retentive address areas)	Yes	
Local data per priority class	max. 510 bytes	
Blocks	CPU 314C-2 PtP	CPU 314C-2 DP
Total	1024 (DBs, FCs, FBs) The maximum number of blocks that can be loaded may be reduced if you are using another MMC.	
OBs	See the Instruction List	
• Size	max. 16 KB	
• Number of free-cycle OBs	1 (OB 1)	
• Number of time-of-day interrupt OBs	1 (OB 10)	
• Number of time-delay interrupt OBs	1 (OB 20)	
• Number of watchdog interrupts	1 (OB 35)	
• Number of process interrupt OBs	1 (OB 40)	
• Number of DPV1 interrupt OBs	-	3 (OB 55, 56, 57)
• Number of startup OBs	1 (OB 100)	
• Number of asynchronous error OBs	4 (OB 80, 82, 85, 87)	5 (OB 80, 82, 85, 86, 87)
• Number of synchronous error OBs	2 (OB 121, 122)	
Nesting depth		
• Per priority class	8	
• Additional within an error OB	4	

Technical data		
	CPU 314C-2 PtP	CPU 314C-2 DP
FBs		
• Number, max.	1024 (in the 0 to 2047 range of numbers)	
• Size	max. 16 KB	
FCs		
• Number, max.	1024 (in the 0 to 2047 range of numbers)	
• Size	max. 16 KB	
Address areas (I/O)	CPU 314C-2 PtP	CPU 314C-2 DP
Total I/O address area		
• Inputs	1024 bytes (user-specific addressing)	1024 bytes (user-specific addressing)
• Outputs	1024 bytes (user-specific addressing)	1024 bytes (user-specific addressing)
• Distributed – Inputs – Outputs	none none	979 bytes 986 bytes
I/O process image		
• Inputs	128 bytes	128 bytes
• Outputs	128 bytes	128 bytes
Digital channels		
• Integrated channels (DI)	24	24
• Integrated channels (DO)	16	16
• Inputs	1016	7856
• Outputs	1008	7904
• Inputs, central	1016	1008
• Outputs, central	1008	1008
Analog channels		
• Integrated channels (AI)	4 + 1	4 + 1
• Integrated channels (AO)	2	2
• Inputs	253	494
• Outputs	250	495
• Inputs, central	253	253
• Outputs, central	250	250
Removal	CPU 314C-2 PtP	CPU 314C-2 DP
Racks	Max. 4	
Modules per rack	max. 8; max. 7 in rack 3	
Number of DP masters		
• Integrated	No	1
• Via CP	4	4

7.5 CPU 314C-2 PtP and CPU 314C-2 DP

Technical data		
	CPU 314C-2 PtP	CPU 314C-2 DP
Operable function modules and communication processors		
• FM	Max. 8	
• CP (PtP)	Max. 8	
• CP (LAN)	Max. 10	
Time	CPU 314C-2 PtP	CPU 314C-2 DP
Clock	Yes (HW clock)	
• Buffered	Yes	
• Buffered period	Typically 6 weeks (at an ambient temperature of 40 °C)	
• Behavior of the clock on expiration of the buffered period	The clock keeps running, continuing at the time-of-day it had when power was switched off.	
• Accuracy	Deviation per day < 10 s	
Operating hours counter	1	
• Number	0	
• Value range	2 ³¹ hours (if SFC 101 is used)	
• Granularity	1 hour	
• Retentive	Yes; must be manually restarted after every restart	
Clock synchronization	Yes	
• In the AS	Master	
• On MPI	Master/slave	
• On DP	-	Master/slave (only time slave if DP slave)
S7 message functions	CPU 314C-2 PtP	CPU 314C-2 DP
Number of stations that can log in for signaling functions (e.g. OS)	Max. 12 (depends on the number of connections configured for PG / OP and S7 basic communication)	
Process diagnostics messages	Yes	
• Simultaneously enabled interrupt S blocks	Max. 40	
Test and startup functions	CPU 314C-2 PtP	CPU 314C-2 DP
Status/control variables	Yes	
• Variable	Inputs, outputs, memory bits, DBs, timers, counters	
• Number of variables	Max. 30	
– of those as status variable	Max. 30	
– of those as control variable	Max. 14	
Force	Yes	
• Variable	Inputs, outputs	
• Number of variables	Max. 10	
Block status	Yes	

Technical data		
	CPU 314C-2 PtP	CPU 314C-2 DP
Single-step	Yes	
Breakpoint	2	
Diagnostics buffer	Yes	
• Number of entries (not configurable)	Max. 100	
Communication functions	CPU 314C-2 PtP	CPU 314C-2 DP
PG/OP communication	Yes	
Global data communication	Yes	
• Number of GD circuits	4	
• Number of GD packets	Max. 4	
– Sending stations	Max. 4	
– Receiving stations	Max. 4	
• Length of GD packets	max. 22 bytes	
– Consistent data	22 bytes	
S7 basic communication	Yes	
• User data per job	max. 76 bytes	
– Consistent data	76 bytes (for X_SEND or X_RCV) 64 bytes (for X_PUT or X_GET as the server)	
S7 communication		
• As server	Yes	
• As client	Yes (via CP and loadable FBs)	
• User data per job	max. 180 bytes (with PUT/GET)	
– Consistent data	64 bytes	
S5-compatible communication	Yes (via CP and loadable FCs)	
Number of connections	Max. 12	
can be used for		
• PG communication	Max. 11	
– Reserved (default)	1	
– Configurable	from 1 to 11	
• OP communication	Max. 11	
– Reserved (default)	1	
– Configurable	from 1 to 11	
• S7-based communication	Max. 8	
– Reserved (default)	0	
– Configurable	from 0 to 8	
Routing	No	Max. 4
Interfaces	CPU 314C-2 PtP	CPU 314C-2 DP
1st interface		
Type of interface	Integrated RS485 interface	
Physics	RS 485	
electrically isolated	No	
Interface power supply (15 to 30 VDC)	Max. 200 mA	

Technical data		
	CPU 314C-2 PtP	CPU 314C-2 DP
Functionality		
• MPI	Yes	
• PROFIBUS DP	No	
• Point-to-point connection	No	
MPI		
Number of connections	12	
Services		
• PG/OP communication	Yes	
• Routing	No	Yes
• Global data communication	Yes	
• S7 basic communication	Yes	
• S7 communication – As server – As client	Yes No (but via CP and loadable FBs)	
• Transmission rates	max. 187.5 kbps	
2nd interface		
	CPU 314C-2 PtP	CPU 314C-2 DP
Type of interface	Integrated RS422/RS485 interface	Integrated RS485 interface
Physics	RS 422/485	RS 485
electrically isolated	Yes	Yes
Interface power supply (15 to 30 VDC)	No	Max. 200 mA
Number of connections	None	12
Functionality		
• MPI	No	No
• PROFIBUS DP	No	Yes
• Point-to-point connection	Yes	No
DP master		
Number of connections	–	12
Services		
• PG/OP communication	–	Yes
• Routing	–	Yes
• Global data communication	–	No
• S7 basic communication	–	Yes (only I blocks)
• S7 communication	–	Yes (only server; configured unilateral connection)
• Constant bus cycle time	–	Yes
• Isochronous mode	–	No
• SYNC/FREEZE	–	Yes

Technical data		
	CPU 314C-2 PtP	CPU 314C-2 DP
<ul style="list-style-type: none"> • Activate/deactivate DP slaves <ul style="list-style-type: none"> – Max. number of DP slaves that can be activated/deactivated simultaneously 	–	Yes 4
<ul style="list-style-type: none"> • DPV1 	–	Yes
<ul style="list-style-type: none"> • Transmission rates 	–	Up to 12 Mbaud
<ul style="list-style-type: none"> • Number of DP slaves per station 	–	Max. 32
<ul style="list-style-type: none"> • Address area 	–	Max. 1 KB I / 1 KB O
<ul style="list-style-type: none"> • User data per DP slave 	–	max. 244 bytes I / 244 bytes O
DP slave		
Number of connections	–	12
Services		
<ul style="list-style-type: none"> • PG/OP communication 	–	Yes
<ul style="list-style-type: none"> • Routing 	–	Yes (only if interface is active)
<ul style="list-style-type: none"> • Global data communication 	–	No
<ul style="list-style-type: none"> • S7 basic communication 	–	No
<ul style="list-style-type: none"> • S7 communication 	–	Yes (only server; configured unilateral connection)
<ul style="list-style-type: none"> • Direct data exchange 	–	Yes
<ul style="list-style-type: none"> • Transmission rates 	–	Up to 12 Mbaud
<ul style="list-style-type: none"> • Intermediate memory 	–	244 bytes I / 244 bytes O
<ul style="list-style-type: none"> • Automatic baud rate search 	–	Yes (only if interface is passive)
<ul style="list-style-type: none"> • Address areas 	–	Max. 32, with max. 32 bytes each
<ul style="list-style-type: none"> • DPV1 	–	No
GSD file	–	The latest GSD file is available at: http://www.automation.siemens.com/csi/gsd
Point-to-point connection		
<ul style="list-style-type: none"> • Transmission rates 	38.4 Kbaud half duplex 19.2 Kbaud full duplex	–
<ul style="list-style-type: none"> • Cable length 	Max. 1200 m	–
<ul style="list-style-type: none"> • User program can control the interface 	Yes	–
<ul style="list-style-type: none"> • The interface can trigger a break or an interrupt in the user program 	Yes (message with break ID)	–
<ul style="list-style-type: none"> • Protocol driver 	3964 (R); ASCII and RK512	–
Programming		
Programming language	LAD/FBD/STL	
Instruction set	see the Instruction List	
Nesting levels	8	

Technical data		
	CPU 314C-2 PtP	CPU 314C-2 DP
System functions (SFC)	see the Instruction List	
System function blocks (SFB)	see the Instruction List	
User program protection	Yes	
Integrated I/O	CPU 314C-2 PtP	CPU 314C-2 DP
<ul style="list-style-type: none"> • Default addresses of the integrated <ul style="list-style-type: none"> – Digital inputs – Digital outputs – Analog inputs – Analog outputs 	124.0 to 126.7 124.0 to 125.7 752 to 761 752 to 755	
Integrated functions		
Counters	4 channels (see the Manual <i>Technological Functions</i>)	
Frequency counters	4 channels, max. 60 kHz (see the Manual <i>Technological Functions</i>)	
Cycle duration measurement	4 channels (see the Manual <i>Technological Functions</i>)	
Pulse outputs	4 channels for pulse width modulation, max. 2.5 kHz (see the Manual <i>Technological Functions</i>)	
Controlled positioning	1 channel (see the Manual <i>Technological Functions</i>)	
Integrated "Controlling" SFB	PID controller (see the manual <i>Technological Functions</i>)	
Dimensions	CPU 314C-2 PtP	CPU 314C-2 DP
Mounting dimensions W x H x D (mm)	120 x 125 x 130	
Weight	approx. 676 g	
Voltages and currents	CPU 314C-2 PtP	CPU 314C-2 DP
Power supply (rated value)	24 VDC	
<ul style="list-style-type: none"> • Permissible range 	20.4 V to 28.8 V	
Current consumption (no-load operation)	Typically 150 mA	
Inrush current	Typically 11 A	
Power consumption (nominal value)	800 mA	1000 mA
I ² t	0.7 A ² s	
External fusing of power supply lines (recommended)	LS switch type C min. 2 A, LS switch type B min. 4 A	
Power loss	Typically 14 W	

7.6 Technical data of the integrated I/O

7.6.1 Arrangement and usage of integrated I/Os

Introduction

The integrated inputs/outputs of the 31xC CPUs can be used for technological functions or as standard IOs.

The figures below illustrate possible usage of I/Os integrated in the CPUs.

Reference

Further information on integrated I/O is found in the Manual *Technical Functions*.

CPU 312C: Pin-out of the integrated DI/DO (connector X11)

Standard	Interrupt input	Counting	X11	
			1 ⌀	
DI	X	Z0 (A)	2 ⌀	DI+0.0
DI	X	Z0 (B)	3 ⌀	DI+0.1
DI	X	Z0 (HW-Tor)	4 ⌀	DI+0.2
DI	X	Z1 (A)	5 ⌀	DI+0.3
DI	X	Z1 (B)	6 ⌀	DI+0.4
DI	X	Z1 (HW-Tor)	7 ⌀	DI+0.5
DI	X	Latch 0	8 ⌀	DI+0.6
DI	X	Latch 1	9 ⌀	DI+0.7
DI	X		10 ⌀	DI+1.0
	X		11 ⌀	DI+1.1
			12 ⌀	2M
			13 ⌀	1L+
DO		V0	14 ⌀	DO+0.0
DO		V1	15 ⌀	DO+0.1
DO			16 ⌀	DO+0.2
DO			17 ⌀	DO+0.3
DO			18 ⌀	DO+0.4
DO			19 ⌀	DO+0.5
			20 ⌀	1M

Zn Counter n
A, B Sensor signals
Vn Comparator n
X Pin can be used, provided it is not in use by technological functions
HW-Tor Gate control
Latch Save counter value

Block diagram of the integrated digital I/O

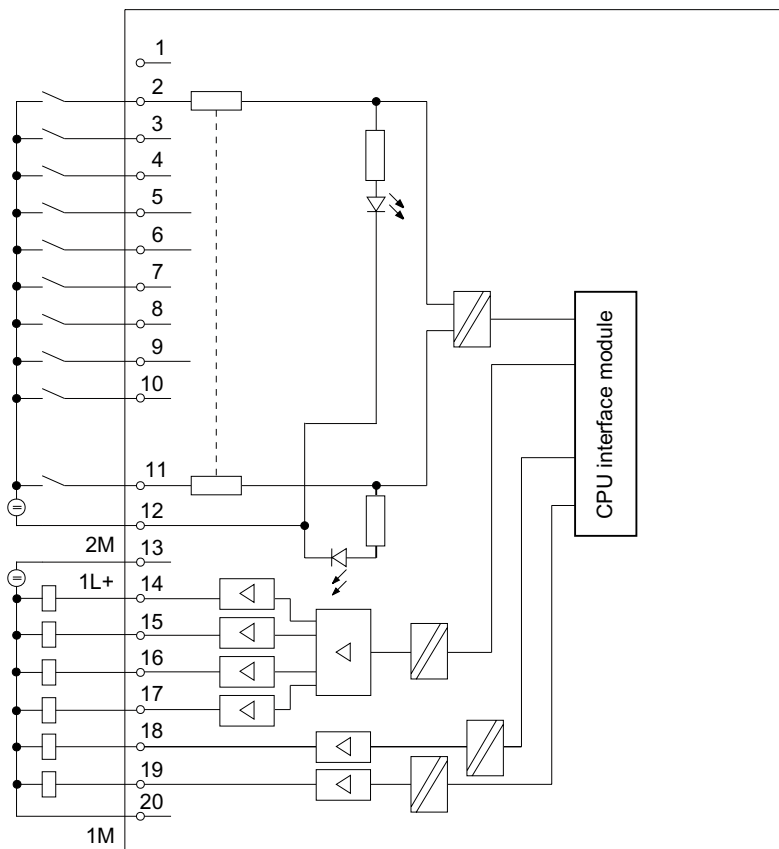

CPU 313C, CPU 313C-2 DP/PtP, CPU 314C-2 DP/PtP: DI/DO (connectors X11 and X12)

X11 of the CPU 313C-2 PtP/DP, CPU 313C-2DP
X12 of the CPU 313C, CPU 314C-2 PtP, CPU 314C-2DP

Standard DI	Interrupt input	Counting	Positioning 1)					Positioning 1)		Counting	Standard DO
				1 Ø	1L+	2L+	Ø 21	Digital	Analog		
X	X	Z0 (A)	A 0	2 Ø	DI+0.0	DO+0.0	Ø 22			V0	X
X	X	Z0 (B)	B 0	3 Ø	DI+0.1	DO+0.1	Ø 23			V1	X
X	X	Z0 (HW-Tor)	N 0	4 Ø	DI+0.2	DO+0.2	Ø 24			V2	X
X	X	Z1 (A)	Tast 0	5 Ø	DI+0.3	DO+0.3	Ø 25			V3 1)	X
X	X	Z1 (B)	Bero 0	6 Ø	DI+0.4	DO+0.4	Ø 26				X
X	X	Z1 (HW-Tor)		7 Ø	DI+0.5	DO+0.5	Ø 27				X
X	X	Z2 (A)		8 Ø	DI+0.6	DO+0.6	Ø 28		CONV_EN		X
X	X	Z2 (B)		9 Ø	DI+0.7	DO+0.7	Ø 29		CONV_DIR		X
				10 Ø		2M	Ø 30				
				11 Ø		3L+	Ø 31				
X	X	Z2 (HW-Tor)		12 Ø	DI+1.0	DO+1.0	Ø 32	R+			X
X	X	Z3 (A)	1)	13 Ø	DI+1.1	DO+1.1	Ø 33	R-			X
X	X	Z3 (B)		14 Ø	DI+1.2	DO+1.2	Ø 34	Eil			X
X	X	Z3 (HW-Tor)		15 Ø	DI+1.3	DO+1.3	Ø 35	Schleich			X
X	X	Z0 (Latch)		16 Ø	DI+1.4	DO+1.4	Ø 36				X
X	X	Z1 (Latch)		17 Ø	DI+1.5	DO+1.5	Ø 37				X
X	X	Z2 (Latch)		18 Ø	DI+1.6	DO+1.6	Ø 38				X
X	X	Z3 (Latch)	1)	19 Ø	DI+1.7	DO+1.7	Ø 39				X
				20 Ø	1M	3M	Ø 40				

- ZN Counter n
- A, B Encoder signals
- HW-Tor Gate control
- Latch Save counter value
- Vn Comparator n
- Tast 0 Probe 0
- Bero 0 Reference point switch 0
- R+, R- Direction signal
- Eil Rapid traverse
- Schleich Creep traverse
- CONV_EN Enable power section
- CONV_DIR Direction signal (only with control mode "voltage 0 to 10 V or current from 0 mA to 10 mA and direction signal")
- X Pin can be used, provided it is not in use by technological functions
- 1) only CPU 314C-2

Reference

Details are found in the Manual *Technical Functions* under *Counting, Frequency Measurement and Pulse Width Modulation*

Block diagram of integrated digital I/O of CPUs 313C/313C-2/314C-2

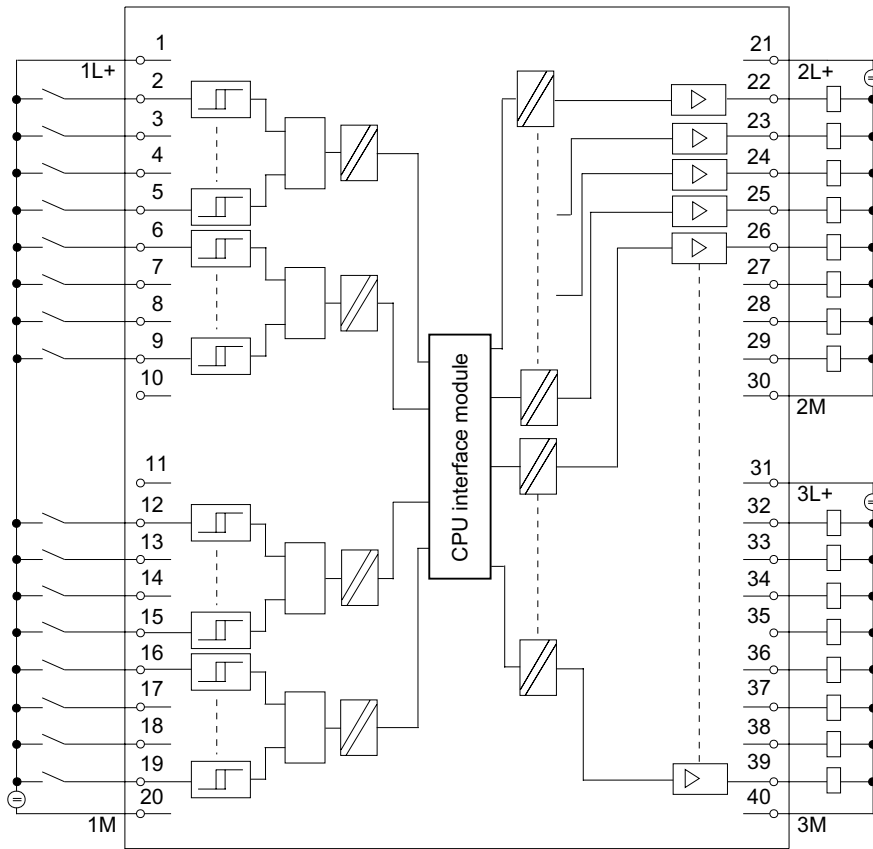

CPU 313C/314C-2: Pin-out of the integrated AI/AO and DI (connector X11)

		X11						
Standard	Position	1			∅ 21	Standard DI	Interrupt input	
AI (Ch0)	V	2 ∅	PEW _{x+0}	DI+2.0	∅ 22	X	X	
	I	3 ∅		DI+2.1	∅ 23	X	X	
	C	4 ∅		DI+2.2	∅ 24	X	X	
AI (Ch1)	V	5 ∅	PEW _{x+2}	DI+2.3	∅ 25	X	X	
	I	6 ∅		DI+2.4	∅ 26	X	X	
	C	7 ∅		DI+2.5	∅ 27	X	X	
AI (Ch2)	V	8 ∅	PEW _{x+4}	DI+2.6	∅ 28	X	X	
	I	9 ∅		DI+2.7	∅ 29	X	X	
	C	10 ∅		4M	∅ 30			
AI (Ch3)	V	11 ∅	PEW _{x+6}		∅ 31			
	I	12 ∅			∅ 32			
	C	13 ∅			∅ 33			
PT 100 (Ch4)		14 ∅	PEW _{x+8}		∅ 34			
		15 ∅			∅ 35			
AO (Ch0)	V	16 ∅	PAW _{x+0}		∅ 36			
	A	17 ∅			∅ 37			
AO (Ch1)	V	18 ∅	PAW _{x+2}		∅ 38			
	A	19 ∅			∅ 39			
		20 ∅	M _{ANA}		∅ 40			

1) only CPU 314C-2

Block diagram of integrated digital/analog I/O of CPUs 313C/314C-2

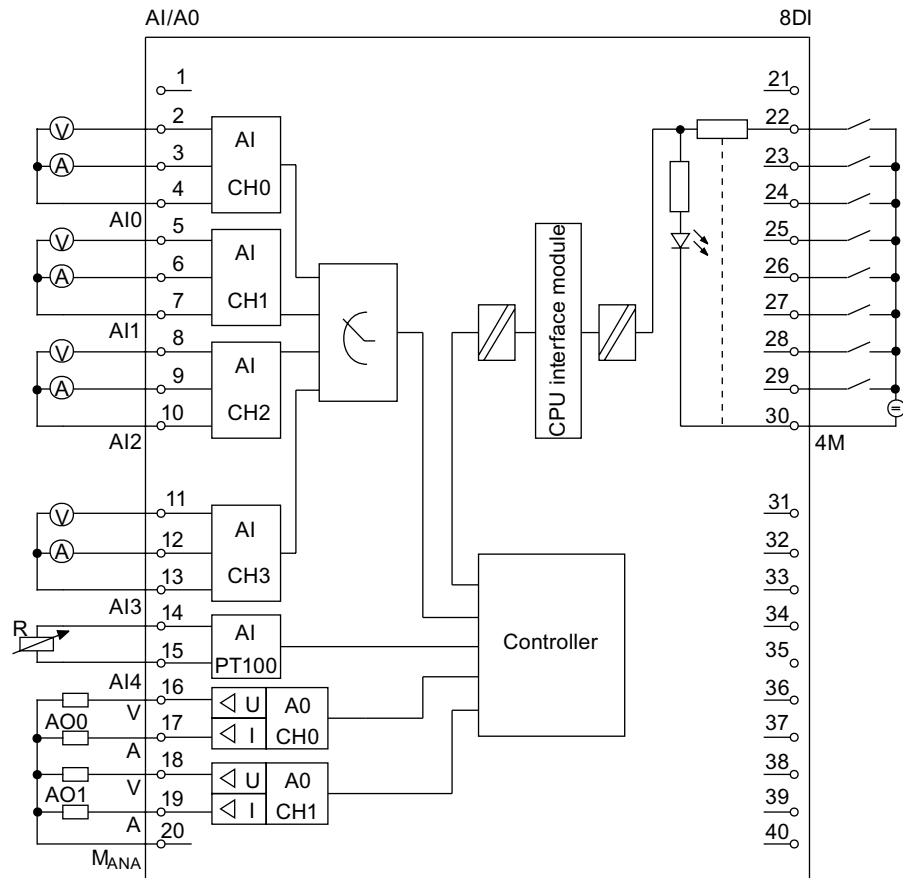

Simultaneous usage of technological functions and standard I/O

Technological functions and standard I/O can be used simultaneously with appropriate hardware. For example, you can use all digital inputs not used for counting functions as standard DI.

Read access to inputs used by technological functions is possible. Write access to outputs used by technological functions is not possible.

See also

CPU 312C (Page 163)

CPU 313C (Page 170)

CPU 313C-2 PtP and CPU 313C-2 DP (Page 177)

CPU 314C-2 PtP and CPU 314C-2 DP (Page 185)

7.6.2 Analog I/O

Abbreviations used in the figures below

M	Ground connection
Mx+	Measuring line "+" (positive), for channel x
Mx-	Measuring line "-" (negative), for channel x
M _{ANA}	Analog-measuring-circuit reference potential
AI _{XU}	Voltage input "+" for channel x
AI _{XI}	Current input "+" for channel x
AI _{XC}	Common current and voltage input "-" for channel x
AI _X	Analog input channel x

Wiring of the current/voltage inputs

The figure below shows the wiring diagram of the current/voltage inputs operated with 2-/4-wire measuring transducers.

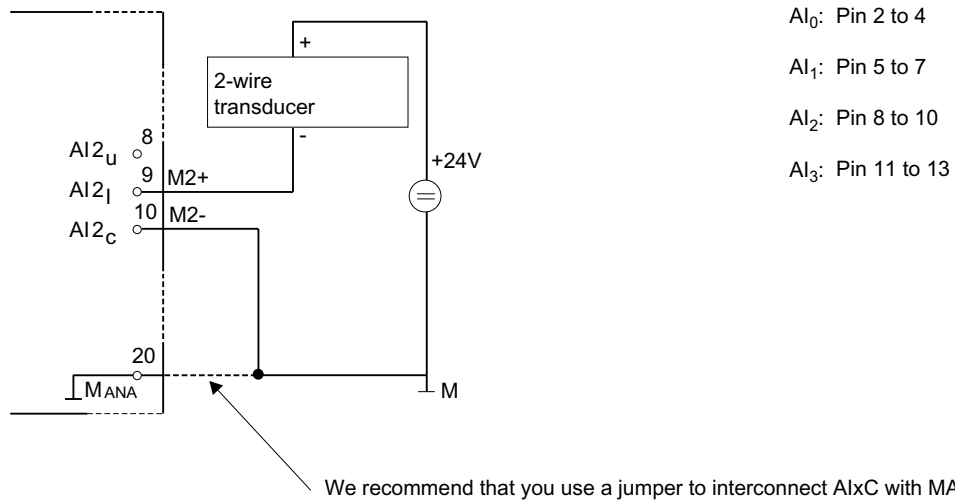

Figure 7-1 Connection of a 2-wire measuring transducer to an analog current/voltage input of CPU 313C/314C-2

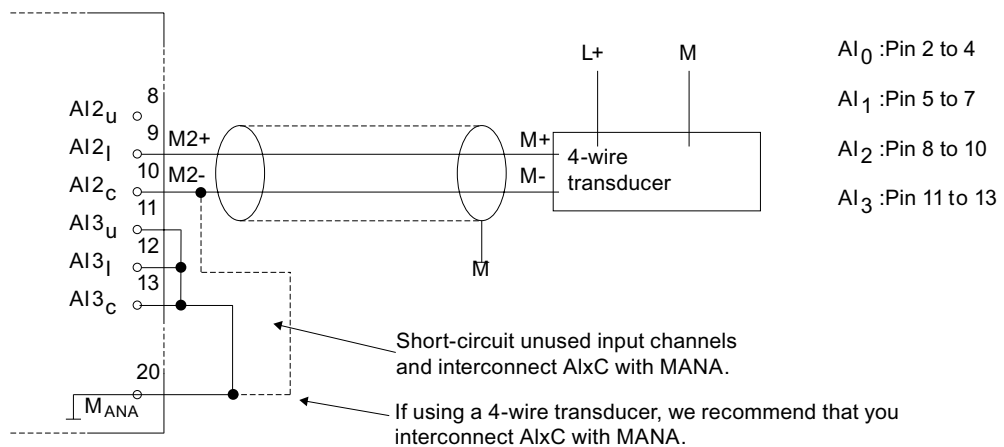

Figure 7-2 Connection of a 4-wire measuring transducer to an analog current/voltage input of CPU 313C/314C-2

Measurement principle

31xC CPUs use the measurement principle of actual value encoding. Here, they operate with a sampling rate of 1 kHz. That is, a new value is available at the peripheral input word register once every millisecond. This value can then be read via user program (e.g., L PEW). The "previous" value is read again if access times are shorter than 1 ms.

Integrated hardware low-pass filter

An integrated low-pass filter attenuates analog input signals of channel 0 to 3. They are attenuated according to the trend in the figure below.

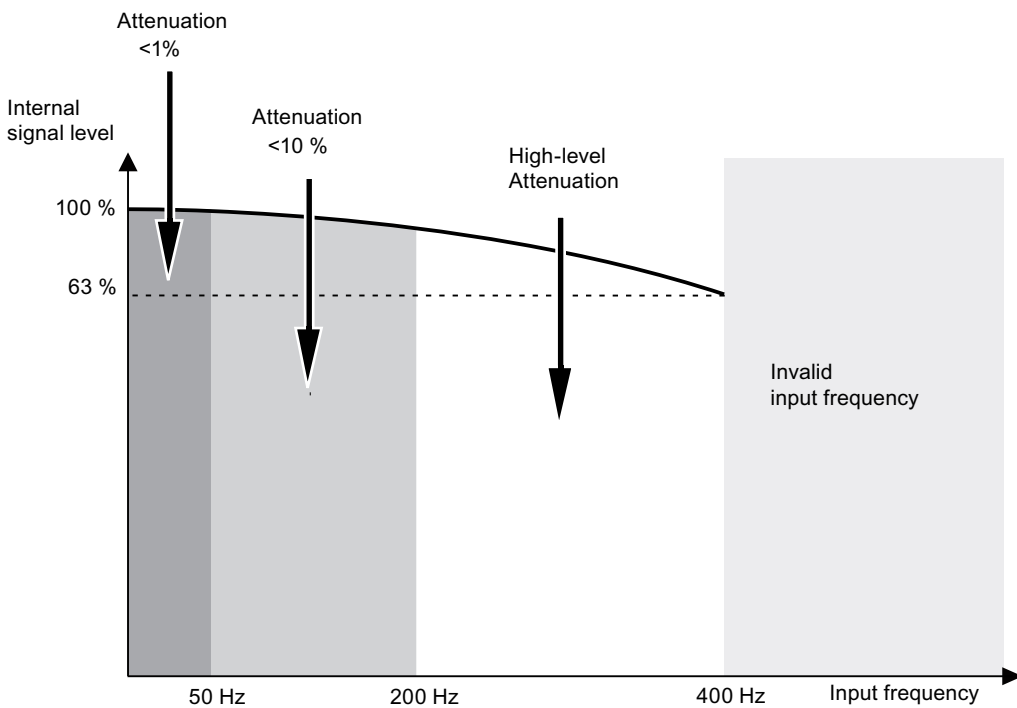

Figure 7-3 Low-pass characteristics of the integrated filter

Note

The maximum frequency of the input signal is 400 Hz.

Input filters (software filter)

The current / voltage inputs have a software filter for the input signals which can be programmed with STEP 7. It filters the configured interference frequency (50/60 Hz) and multiples thereof.

The selected interference suppression also determines the integration time.

At an interference suppression of 50 Hz the software filter forms the average based on the last 20 measurements and saves the result as a measurement value.

You can suppress interference frequencies (50 Hz or 60 Hz) according to the parameters set in STEP 7. A setting of 400 Hz will not suppress interference.

An integrated low-pass filter attenuates analog input signals of channel 0 to 3.

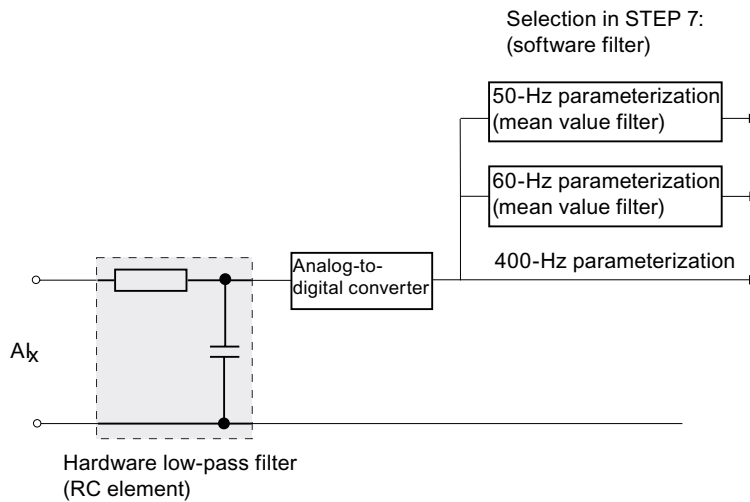

Figure 7-4 Principle of interference suppression with STEP 7

In the two graphics below we illustrate how the 50 Hz and 60 Hz interference suppression work

Example of 50 Hz interference frequency suppression (integration time corresponds to 20 ms)

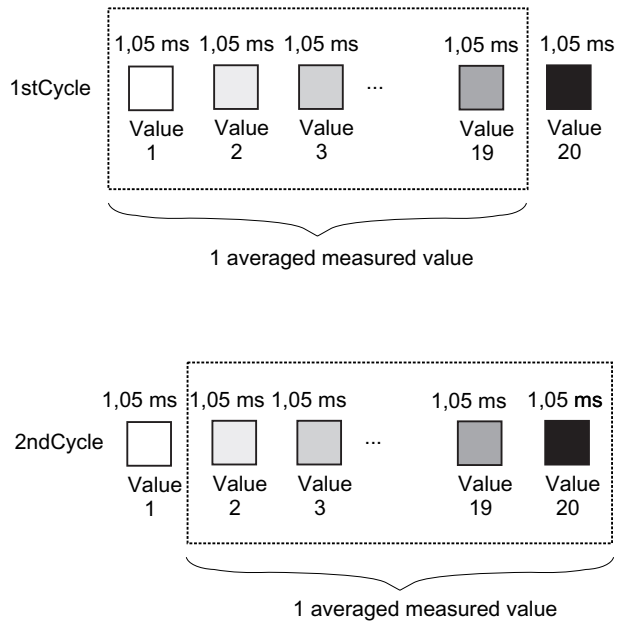

Figure 7-5 50 Hz interference suppression

Example of 60 Hz interference frequency suppression (integration time corresponds to 16,7 ms)

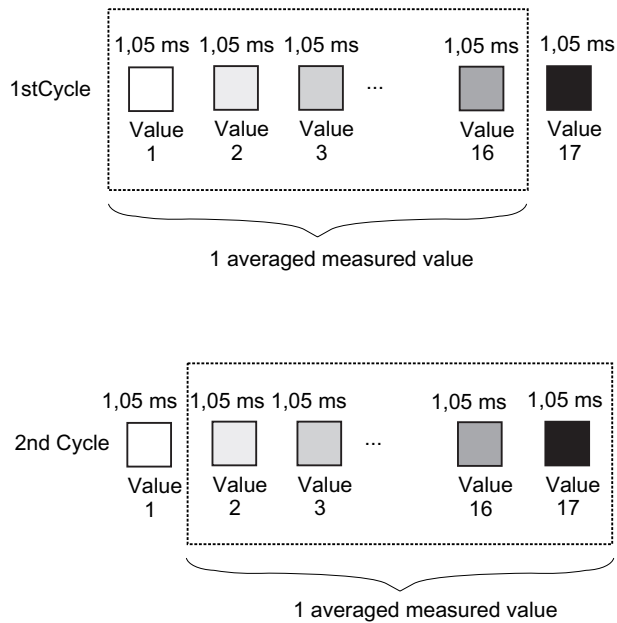

Figure 7-6 60 Hz interference suppression

Note

If the interference frequency is not 50/60 Hz or a multiple thereof, the input signal must be filtered externally,
In this case, 400 Hz frequency suppression must be configured for the respective input. This is equivalent to a "Deactivation" of the software filter.

Inputs not connected

The three inputs of a current/voltage analog output channel that is not connected should be bypasses and connected to M_{ANA} (pin 20 of the front connector). This ensures maximum interference resistance for these analog inputs.

Outputs not connected

In order to disconnect unused analog outputs from power, you must disable and leave them open during parameter assignment with STEP 7.

Reference

For further information (visualization and processing of analog values, for example), refer to Chapter 4 of the *Module Data* Manual.

7.6.3 Configuration

Introduction

You configure the integrated I/O of CPU 31xC with STEP 7. Always make these settings when the CPU is in STOP. The generated parameters are downloaded from the PG to the S7-300 and written to CPU memory.

You can also choose to change the parameters at SFC 55 in the user program (see the Reference Manual *System and Standard Functions*). Refer to the structure of record 1 for the respective parameters.

Parameters of standard DI

The table below gives you an overview of the parameters for standard digital inputs.

Table 7- 7 Parameters of standard DI

Parameters	Value range	Default	Range of efficiency
Input delay (ms)	0,1/0,5/3/15	3	Channel group

The table below gives you an overview of the parameters when using digital inputs as interrupt inputs.

Table 7- 8 Parameters of the interrupt inputs

Parameters	Range of values	Default setting	Efficiency range
Interrupt input	Disabled / positive edge	De-activated	digital input
Interrupt input	Disabled/ negative edge	Deactivated	Digital input

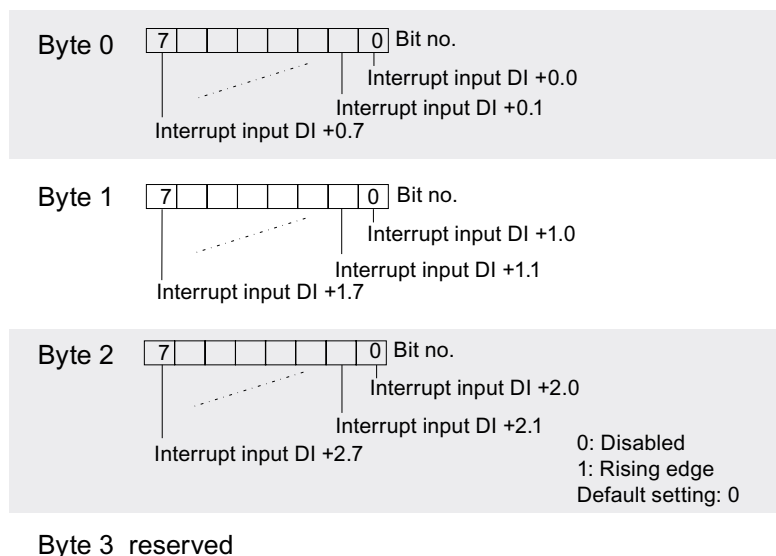

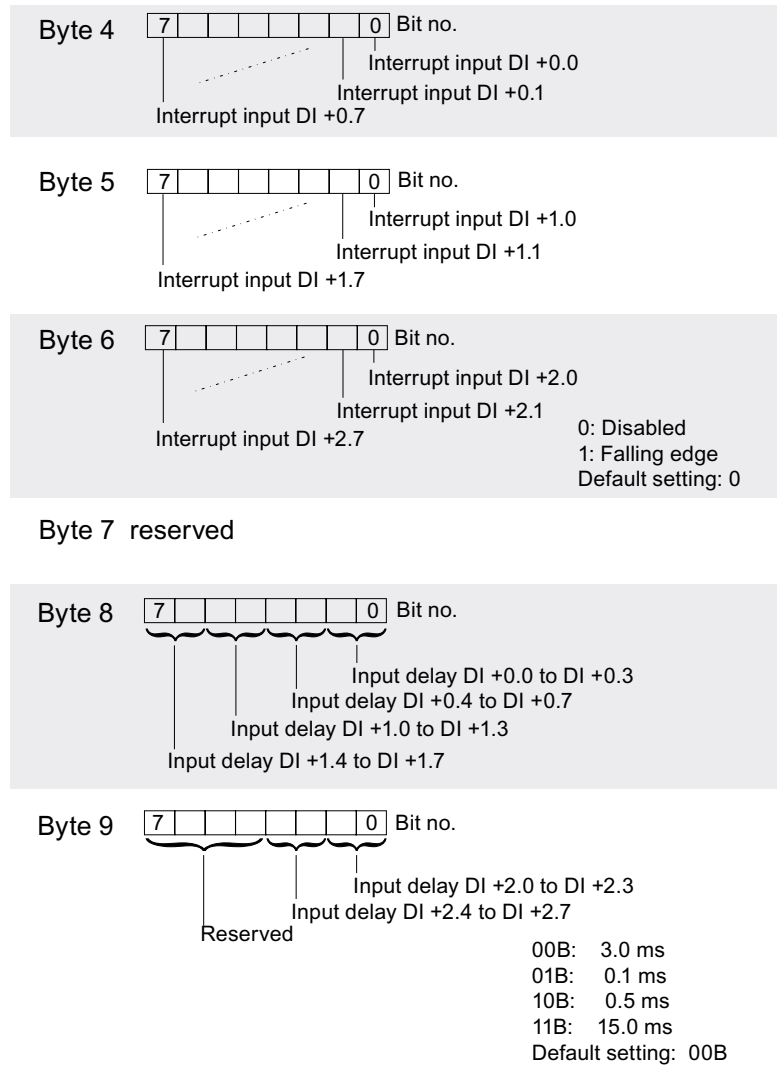

Figure 7-7 Structure of record 1 for standard DI and interrupt inputs (length of 10 bytes)

Parameters of standard DO

There are no parameters for standard digital outputs.

Parameters of standard AI

The table below gives you an overview of the parameters for standard analog inputs.

Table 7-9 Parameters of standard AI

Parameters	Range of values	Default setting	Efficiency range
Integration time (ms)	2,5/16,6/20	20	Channel
Interference suppression (Hz) (channel 0 to 3)	400/60/50	50	Channel
Measurement range (channel 0 to 3)	deactivated/ +/- 20 mA/ 0 ... 20 mA/ 4 ... 20 mA/ +/- 10 V/ 0 ... 10 V	+/- 10 V	Channel
Type of measurement (channel 0 to 3)	deactivated/ U voltage/ I current	U voltage	Channel
Unit of measurement (channel 4)	Celsius/Fahrenheit/ Kelvin	Celsius	Channel
Measurement range (Pt 100 input; channel 4)	deactivated/ Pt 100/600 Ω	600 Ω	Channel
Type of measurement (Pt 100 input; channel 4)	deactivated/ Resistance/ Thermal resistance	Resistance	Channel

Reference

See also Chapter 4.3 in the *Module Data Reference Manual*.

Parameters of standard AO

The table below gives you an overview of standard analog output parameters (see also Chapter 4.3 in the *Module Data Reference Manual*).

Table 7- 10 Parameters of standard AO

Parameters	Range of values	Default setting	Efficiency range
Output range (channel 0 to 1)	Deactivated/ +/- 20 mA/ 0 ... 20 mA/ 4 ... 20 mA/ +/- 10 V/ 0 ... 10 V	+/- 10 V	Channel
Type of output (channel 0 to 1)	Deactivated/ U voltage/ I current	U voltage	Channel

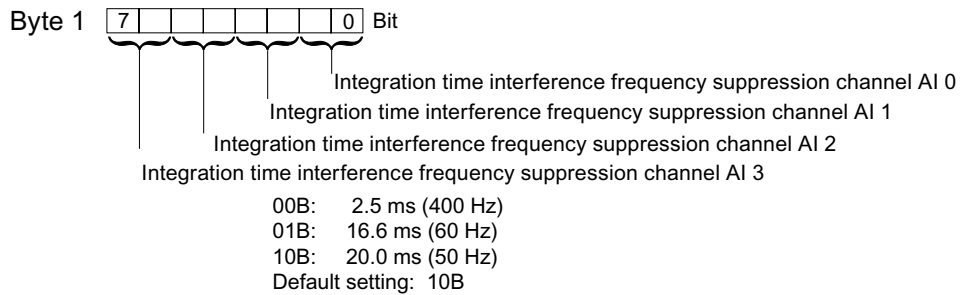
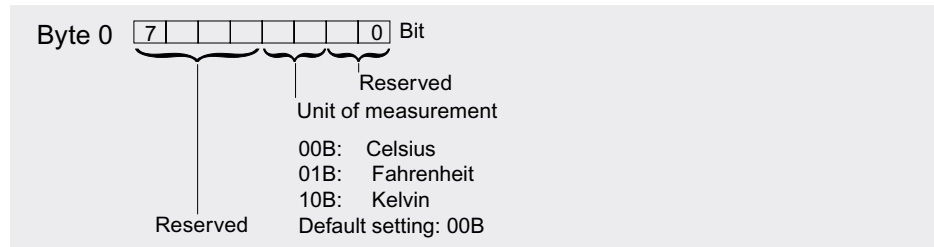

Byte 2: Reserved

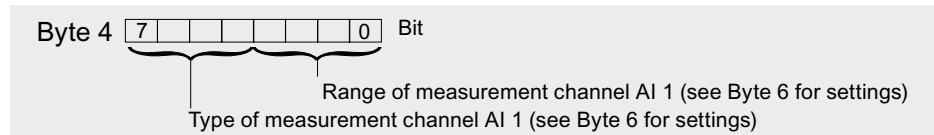
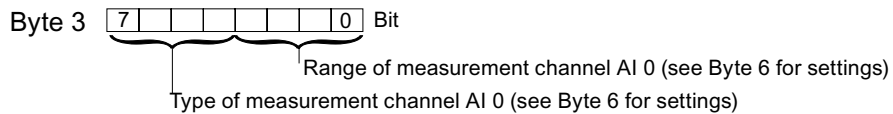

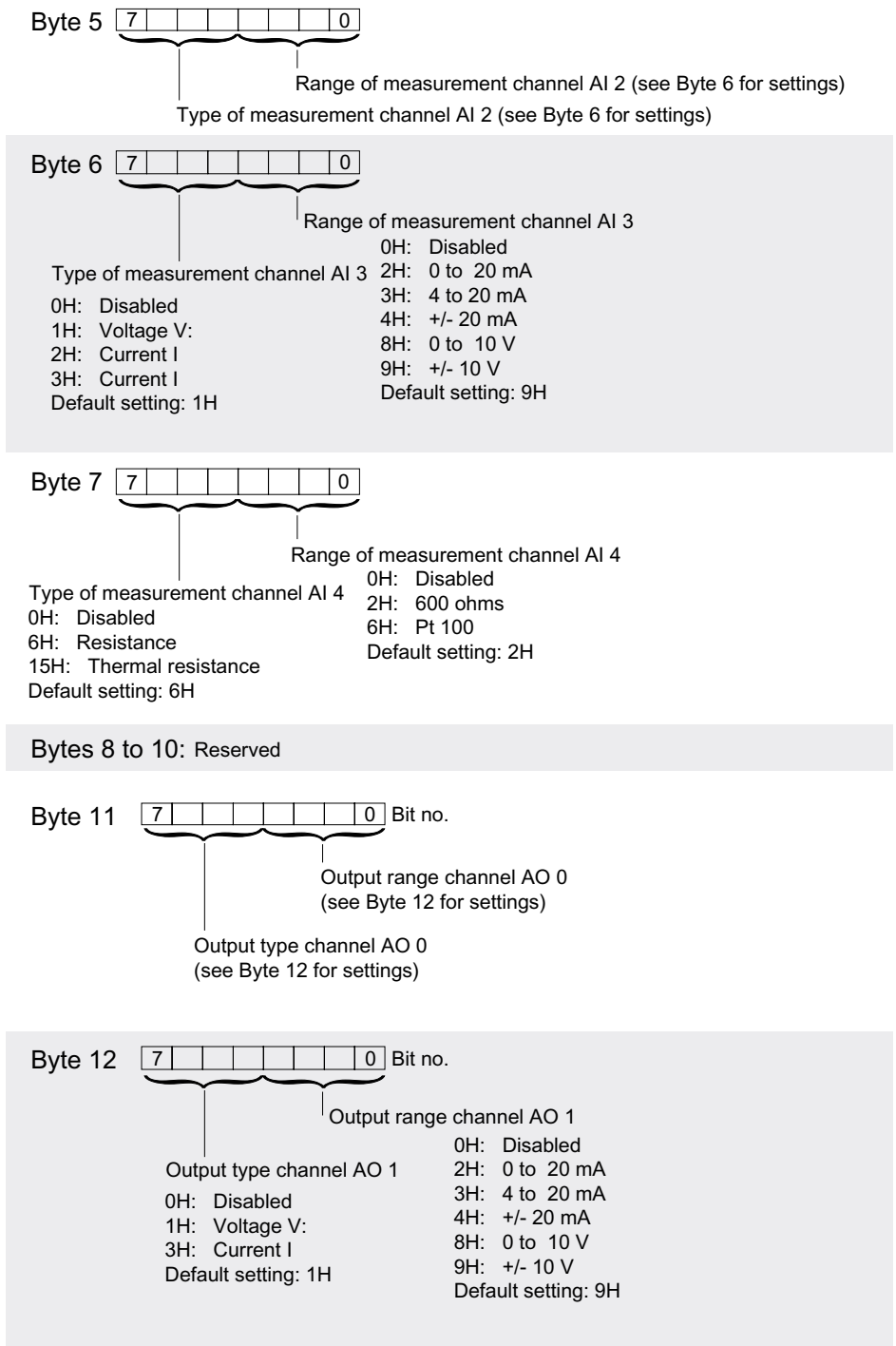

Figure 7-8 Structure of record 1 for standard AI/AO (length of 13 bytes)

Parameter for technological functions

The parameters for the respective function are found in the Manual *Technological Functions*.

7.6.4 Interrupts

Interrupt inputs

All digital inputs of the on-board I/O of CPUs 31xC can be used as interrupt inputs.

You can specify interrupt behavior for each individual input in your parameter declaration. Options are:

- no interrupt
- Interrupt at the positive edge
- Interrupt at the negative edge
- Interrupt at the positive and negative edge

Note

Every channel will hold one event if the rate of incoming interrupts exceeds the handling capacity of OB40. Further events (interrupts) will be lost, without diagnostics or explicit message.

Start information for OB40

The table below shows the relevant temporary variables (TEMP) of OB40 for the interrupt inputs of 31xC CPUs. A description of process interrupt OB 40 is found in the Reference Manual *System and Standard Functions*.

Table 7- 11 Start information for OB40, relating to the interrupt inputs of the integrated I/O

Byte	Variables	Data type		Description
6/7	OB40_MDL_ADDR	WORD	B#16#7C	Address of the interrupt-triggering module (here: default addresses of the digital inputs)
8 on	OB40_POINT_ADDR	DWORD	see the figure below	Displaying the interrupt-triggering integrated inputs

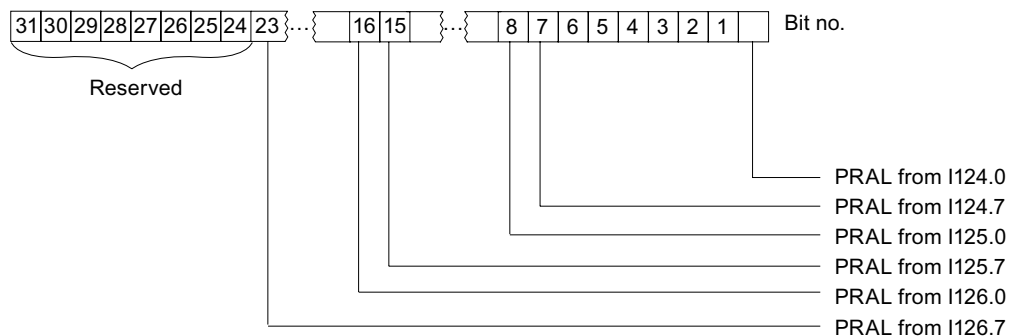

Figure 7-9 Displaying the statuses of CPU 31xC interrupt inputs

PRAL: process interrupt

The inputs are assigned default addresses.

7.6.5 Diagnostics

Standard I/O

Diagnostic data is not available for integrated I/O which is operated as standard I/O (see also the Reference Manual *Module Data*).

Technological functions

Diagnostics options for the respective technological function are found in the Manual *Technological Functions*.

7.6.6 Digital inputs

Introduction

This section provides the specifications for the digital inputs of CPUs 31xC.

The table includes the following CPUs:

- under CPU 313C-2, the CPU 313C-2 DP and CPU 313C-2 PtP
- under CPU 314C-2, the CPU 314C-2 DP and CPU 314C-2 PtP

Technical data

Table 7- 12 Technical data of digital inputs

Technical data				
	CPU 312C	CPU 313C	CPU 313C-2	CPU 314C-2
Module-specific data	CPU 312C	CPU 313C	CPU 313C-2	CPU 314C-2
Number of inputs	10	24	16	24
• Number of these inputs which can be used for technological functions	8	12	12	16
Cable length				
• Unshielded	For standard DI: Max. 600 m For technological functions: No			
• Shielded	For standard DI: Max. 1.000 m			
	For technological function at max. counting frequency			
	100 m	100 m	100 m	50 m
Voltage, currents, potentials	CPU 312C	CPU 313C	CPU 313C-2	CPU 314C-2
Rated load voltage L+	24 VDC			
• Polarity reversal protection	Yes			

Technical data				
	CPU 312C	CPU 313C	CPU 313C-2	CPU 314C-2
Number of inputs which can be controlled simultaneously				
<ul style="list-style-type: none"> Horizontal assembly <ul style="list-style-type: none"> Up to 40° C Up to 60 °C 	10 5	24 12	16 8	24 12
<ul style="list-style-type: none"> Vertical assembly <ul style="list-style-type: none"> Up to 40°C 	5	12	8	12
Electrical isolation				
<ul style="list-style-type: none"> Between channels and the backplane bus 	Yes			
<ul style="list-style-type: none"> Between the channels 	No			
Permitted potential difference				
<ul style="list-style-type: none"> Between different circuits 	75 VDC / 60 VAC			
Insulation test voltage	600 VDC			
Current consumption				
<ul style="list-style-type: none"> On load voltage L+ (no-load) 	–	Max. 70 mA	Max. 70 mA	Max. 70 mA
Status, interrupts, diagnostics	CPU 312C	CPU 313C	CPU 313C-2	CPU 314C-2
Status display	green LED per channel			
Interrupts	<ul style="list-style-type: none"> Yes, if the corresponding channel is configured as interrupt input For using technological functions, please refer to the <i>Technological Functions</i> Manual. 			
Diagnostics functions	<ul style="list-style-type: none"> no diagnostics when operated as standard I/O For using technological functions, please refer to the <i>Technological Functions</i> Manual. 			
Data for the selection of an encoder for standard DI	CPU 312C	CPU 313C	CPU 313C-2	CPU 314C-2
Input voltage				
<ul style="list-style-type: none"> Rated value 	24 VDC			
<ul style="list-style-type: none"> For signal "1" 	15 V to 30 V			
<ul style="list-style-type: none"> For signal "0" 	-3 V to 5 V			
Input current				
<ul style="list-style-type: none"> For signal "1" 	Typically 9 mA			

7.6 Technical data of the integrated I/O

Technical data				
	CPU 312C	CPU 313C	CPU 313C-2	CPU 314C-2
Delay of standard inputs				
<ul style="list-style-type: none"> Configurable 	Yes (0.1 / 0.5 / 3 / 15 ms) You can reconfigure the input delay of the standard inputs during program runtime. Please note that your newly set filter time may only take effect after the previously set filter time has expired.			
<ul style="list-style-type: none"> Rated value 	3 ms			
For using technological functions: "Minimum pulse width/ minimum pause between pulses at maximum counting frequency"	48 µs	16 µs	16 µs	8 µs
Input characteristics curve	to IEC 1131, type 1			
Connection of 2wire BEROs	Supported			
<ul style="list-style-type: none"> Permitted quiescent current 	Max. 1.5 mA			

7.6.7 Digital outputs

Introduction

This chapter contains the specifications for the digital outputs of CPUs 31xC.

The table includes the following CPUs:

- under CPU 313C-2, the CPU 313C-2 DP and CPU 313C-2 PtP
- under CPU 314C-2, the CPU 314C-2 DP and CPU 314C-2 PtP

Fast digital outputs

Technological functions use fast digital outputs.

Technical data

Table 7- 13 Technical data of digital outputs

Technical data				
	CPU 312C	CPU 313C	CPU 313C-2	CPU 314C-2
Module-specific data	CPU 312C	CPU 313C	CPU 313C-2	CPU 314C-2
Number of outputs	6	16	16	16
• Of those are fast outputs	2	4	4	4
	Caution: You cannot connect the high-speed outputs of your CPU in parallel.			
Cable length				
• Unshielded	Max. 600 m			
• Shielded	Max. 1,000 m			
Voltage, currents, potentials	CPU 312C	CPU 313C	CPU 313C-2	CPU 314C-2
Rated load voltage L+	24 VDC			
• Polarity reversal protection	No			
Total current of outputs (per group)				
• Horizontal assembly				
– Up to 40°C	Max. 2.0 A	Max. 3.0 A	Max. 3.0 A	Max. 3.0 A
– Up to 60 °C	Max. 1.5 A	Max. 2.0 A	Max. 2.0 A	Max. 2.0 A
• Vertical assembly				
– Up to 40°C	Max. 1.5 A	Max. 2.0 A	Max. 2.0 A	Max. 2.0 A
Electrical isolation				
• Between channels and the backplane bus	Yes			
• Between the channels	No	Yes	Yes	Yes
– In groups of	–	8	8	8
Permitted potential difference				
• Between different circuits	75 VDC / 60 VAC			

Technical data				
	CPU 312C	CPU 313C	CPU 313C-2	CPU 314C-2
Insulation test voltage	600 V DC			
Current consumption				
• with load voltage L+	Max. 50 mA	Max. 100 mA	Max. 100 mA	Max. 100 mA
Status, interrupts, diagnostics	CPU 312C	CPU 313C	CPU 313C-2	CPU 314C-2
Status display	green LED per channel			
Interrupts	<ul style="list-style-type: none"> no interrupts when operated as standard I/O For using technological functions, please refer to the <i>Technological Functions</i> Manual. 			
Diagnostics functions	<ul style="list-style-type: none"> no diagnostics when operated as standard I/O For using technological functions, please refer to the <i>Technological Functions</i> Manual. 			
Data for the selection of an actuator for standard DI	CPU 312C	CPU 313C	CPU 313C-2	CPU 314C-2
Output voltage				
• For signal "1"	Min. L+ (-0.8 V)			
Output current				
• For signal "1"	0.5 A			
– Rated value	5 mA to 0.6 A			
– Permissible range				
• For signal "0" (residual current)	Max. 0.5 mA			
Load impedance range	48 Ω to 4 kΩ			
Lamp load	Max. 5 W			
Parallel connection of 2 outputs				
• for redundant load control	Supported			
• for performance increase	Not possible			
Controlling of digital inputs	Supported			
Switching frequency				
• under resistive load	Max. 100 Hz			
• For inductive load to IEC 947-5, DC13	Max. 0.5 Hz			
• under lamp load	Max. 100 Hz			
• fast outputs under resistive load	Max. 2.5 kHz			
Inductive breaking voltage limited internally to	Typically (L+) - 48 V			
Short-circuit protection of the output	Yes, electronic			
• Response threshold	Typically 1 A			

7.6.8 Analog inputs

Introduction

This chapter contains the specifications for analog inputs of the CPUs 31xC.

The table includes the following CPUs:

- CPU 313C
- CPU 314C-2 DP
- CPU 314C-2 PtP

Technical data

Table 7- 14 Technical data of analog inputs

Technical data	
Module-specific data	
Number of inputs	4 channels with current/voltage input 1 channel with resistance input
Cable length	
• Shielded	Max. 100 m
Voltage, currents, potentials	
Resistance input	
• No-load voltage	Typically 2.5 V
• Measurement current	Typically 1.8 mA to 3.3 mA
Electrical isolation	
• between channels and the backplane bus	Yes
• between the channels	No
Permissible potential difference	
• Between inputs (A _{IC}) and M _{ANA} (U _{CM})	8.0 VDC
• between M _{ANA} and M _{internal} (U _{ISO})	75 VDC / 60 VAC
Insulation test voltage	600 V DC
Generation of analog values	
Measurement principle	Actual value encoding (successive approximation)
Integration time/conversion time/resolution (per channel)	
• Configurable	Yes
• Integration time in ms	2,5 / 16,6 / 20
• Permitted input frequency	Max. 400 Hz
• Resolution (including overshoot range)	11 bits + signed bit
• Suppression of interference frequency f1	400 / 60 / 50 Hz
Time constant of the input filter	0:38 ms

7.6 Technical data of the integrated I/O

Technical data	
Basic processing time	1 ms
Noise suppression, error limits	
Interference voltage suppression for $f = nx$ ($f1 \pm 1\%$), ($f1 =$ interference frequency), $n = 1.2$	
• Commonmode interference ($U_{CM} < 1.0\text{ V}$)	> 40 dB
• Feedback interference (peak value of the interference < rated value of the input range)	> 30 dB
Crosstalk between the inputs	> 60 dB
Operational error limits (across the temperature range, in relation to input range)	
• Voltage / current	< 1 %
• Resistance	< 5 %
Basic error limit (operational limit at 25 °C, in relation to input range)	
• Voltage/current – Linearity error during measurement of current and voltage (related to input range)	< 0,8 % $\pm 0,06\%$
• Resistance – Linearity error during resistance measurement (related to input range)	< 3 % $\pm 0,2\%$
Temperature error (in relation to input range)	$\pm 0.006\%/K$
Repeat accuracy (in transient state at 25 °C, in relation to input range)	$\pm 0,06\%$
Status, interrupts, diagnostics	
Interrupts	• no interrupts when operated as standard I/O
Diagnostics functions	• no diagnostics when operated as standard I/O • For using technological functions, please refer to the <i>Technological Functions Manual</i> .
Encoder selection data	
Input ranges (rated value)/input resistance	
• Voltage	$\pm 10\text{ V}/100\text{ k}\Omega$ 0 V to 10 V/100 k Ω
• Current	$\pm 20\text{ mA}/50\ \Omega$ 0 mA to 20 mA/50 Ω 4 mA to 20 mA/50 Ω
• Resistance	0 Ω to 600 Ω /10 M Ω
• Resistance thermometer	Pt 100/10 M Ω
Permitted continuous input voltage (destruction limit)	
• For voltage inputs	Max. 30 V
• For current inputs	Max. 2.5 V

Technical data	
Permitted continuous input current (destruction limit)	
<ul style="list-style-type: none"> • For voltage inputs 	Max. 0.5 mA;
<ul style="list-style-type: none"> • For current inputs 	Max. 50 mA, continuous
Connection of signal generators	
<ul style="list-style-type: none"> • For voltage measurement 	supported
<ul style="list-style-type: none"> • For current measurement <ul style="list-style-type: none"> – as 2-wire measuring transducer – as 4-wire measuring transducer 	Possible, with external power supply supported
<ul style="list-style-type: none"> • for measuring resistance <ul style="list-style-type: none"> – with 2-conductor terminal – with 3-wire connection – with 4-wire connection 	Possible, without compensation of cable resistance Not possible Not possible
Linearization of the characteristics trend	By software
<ul style="list-style-type: none"> • For resistance thermometers 	Pt 100
Temperature compensation	No
Technical unit for temperature measurement	Degrees Celsius/Fahrenheit/Kelvin

7.6.9 Analog outputs

Introduction

This chapter contains the specifications for analog outputs of CPUs 31xC.

The table includes the following CPUs:

- CPU 313C
- CPU 314C-2 DP
- CPU 314C-2 PtP

Technical data

Table 7- 15 Technical data of analog outputs

Technical data	
Module-specific data	
Number of outputs	2
Cable length	
• shielded	Max. 200 m
Voltage, currents, potentials	
Rated load voltage L+	24 VDC
• Polarity reversal protection	Yes
Electrical isolation	
• between channels and the backplane bus	Yes
• Between channels	No
Permissible potential difference	
• between M _{ANA} and M _{internal} (U _{ISO})	75 VDC / 60 VAC
Isolation test voltage	600 VDC
Generation of analog values	
Resolution (including overshoot range)	11 bits + signed bit
Conversion time (per channel)	1 ms
Settling time	
• with resistive load	0.6 ms
• With capacitive load	1.0 ms
• With inductive load	0.5 ms
Noise suppression, error limits	
Crosstalk between the outputs	> 60 dB
Operational error limits (across the temperature range, in relation to output range)	
• Voltage/current	± 1 %

Technical data	
Basic error limit (operational limit at 25 °C, in relation to output range)	
• Voltage/current	± 0,8 %
Temperature error (in relation to output range)	± 0.01 %/K
Linearity error (in relation to output range)	± 0,15 %
Repeat accuracy (in transient state at 25 °C, in relation to output range)	± 0,06 %
Output ripple; bandwidth 0 to 50 kHz (in relation to output range)	± 0,1 %
Status, interrupts, diagnostics	
Interrupts	<ul style="list-style-type: none"> no interrupts when operated as standard I/O For using technological functions, please refer to the <i>Technological Functions Manual</i>.
Diagnostics functions	<ul style="list-style-type: none"> no diagnostics when operated as standard I/O For using technological functions, please refer to the <i>Technological Functions Manual</i>.
Actuator selection data	
Output range (rated values)	
• Voltage	± 10 V 0 V to 10 V
• Current	± 20 mA 0 mA to 20 mA 4 mA to 20 mA
Load resistance (within output rating)	
• For voltage outputs – Capacitive load	min. 1 kΩ Max. 0.1 μF
• For current outputs – Inductive load	Max. 300 Ω 0.1 mH
Voltage output	
• Short-circuit protection	Yes
• Short-circuit current	Typically 55 mA
Current output	
• No-load voltage	Typically 17 V
Destruction limit for externally applied voltages/currents	
• Voltage measured between the outputs and M _{ANA}	Max. 16 V
• Current	Max. 50 mA, continuous
Connection of actuators	
• For voltage outputs – 2-wire connection – 4-wire connection (measuring line)	Possible, without compensation of cable resistance Not possible
• For current outputs – 2-wire connection	supported

Technical data of CPU 31x

8.1 General technical data

8.1.1 Dimensions of CPU 31x

Each CPU features the same height and depth, only the width dimensions differ.

- Height: 125 mm
- Depth: 115 mm, or 180 mm with opened front cover.

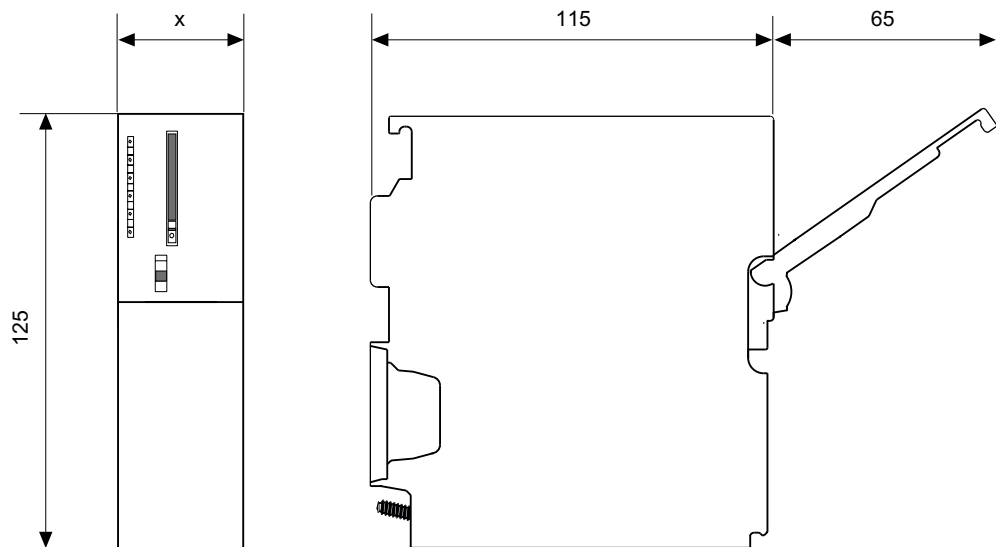

Figure 8-1 Dimensions of CPU 31x

8.1 General technical data

Width of CPU

CPU	Width (x)
CPU 312	40 mm
CPU 314	40 mm
CPU 315-2 DP	40 mm
CPU 315-2 PN/DP	80 mm
CPU 317-2 DP	80 mm
CPU 317-2 PN/DP	80 mm
CPU 319	120 mm

8.1.2 Technical data of the SIMATIC Micro Memory Card

Plug-in SIMATIC Micro Memory Cards

The following memory modules are available:

Table 8- 1 Available SIMATIC Micro Memory Cards

Type			Order number	Required for a firmware update via SIMATIC Micro Memory Card
Micro Memory Card	64	Kbyte	6ES7953-8LFxx-0AA0	–
Micro Memory Card	128	Kbyte	6ES7953-8LGxx-0AA0	–
Micro Memory Card	512	Kbyte	6ES7953-8LJxx-0AA0	–
Micro Memory Card	2	MB	6ES7953-8LLxx-0AA0	Minimum requirement for CPUs without DP interface
Micro Memory Card	4	MB	6ES7953-8LMxx-0AA0	Minimum requirement for CPUs without DP interface (except CPU 319)
Micro Memory Card	8	MB ¹	6ES7953-8LPxx-0AA0	Minimum requirements for the CPU 319

¹ If you plug in the CPU 312C or CPU 312, you cannot use this SIMATIC Micro Memory Card.

Maximum number of loadable blocks on the SIMATIC Micro Memory Card

Number of blocks that can be stored on the SIMATIC Micro Memory Card depends on the capacity of the SIMATIC Micro Memory Card being used. The maximum number of blocks that can be loaded is therefore limited by the capacity of your SIMATIC Micro Memory Card (including blocks generated with the "CREATE DB" SFC)

Table 8- 2 Maximum number of loadable blocks on the SIMATIC Micro Memory Card

Size of SIMATIC Micro Memory Card		... Maximum number of blocks that can be loaded
64	Kbyte	768
128	Kbyte	1024
512	Kbyte	Here the maximum number of blocks that can be loaded for the specific CPU is less than the number of blocks that can be stored on the SIMATIC Micro Memory Card.
2	MB	
4	MB	Refer to the corresponding specifications of a specific CPU to determine the maximum number of blocks that can be loaded.
8	MB	

8.2 CPU 312

Technical data

Table 8- 3 Technical data for the CPU 312

Technical data	
CPU and version	
Order no. [MLFB]	6ES7312-1AE13-0AB0
• Hardware version	01
• Firmware version	V2.6
• Associated programming package	STEP 7 V 5.4 + SP 3 and higher or STEP 7 V 5.2 + SP1 and higher with HSP 0124
Memory	
Work memory	
• Integrated	32 KB
• Expandable	No
Load memory	Pluggable by means of Micro Memory Card (max. 4 MB)
Data storage life on the Micro Memory Card (following final programming)	At least 10 years
Buffering	Guaranteed by Micro Memory Card (maintenance-free)
Execution times	
Processing times of	
• Bit operations	Min. 0.2 µs
• Word instructions	Min. 0.4 µs

Technical data	
• Fixed-point arithmetic	Min. 5 µs
• Floating-point arithmetic	Min. 6 µs
Timers/counters and their retentive address areas	
S7 counters	128
• Retentivity	Configurable
• Default	From C0 to C7
• Counting range	0 to 999
IEC Counters	Yes
• Type	SFB
• Number	unlimited (limited only by work memory size)
S7 timers	128
• Retentivity	Configurable
• Default	Not retentive
• Timer range	10 ms to 9990 s
IEC timers	Yes
• Type	SFB
• Number	unlimited (limited only by work memory size)
Data areas and their retentive address areas	
Bit memory	128 bytes
• Retentivity	Yes
• Preset retentive address areas	MB 0 to MB 15
Clock flag bits	8 (1 memory byte)
Data blocks	511 (in the 1 to 511 range of numbers)
• Size	Max. 16 KB
• Non-retain support (configurable retentive address areas)	Yes
Local data per priority class	Max. 256 bytes
Blocks	
Total	1024 (DBs, FCs, FBs) The maximum number of blocks that can be loaded may be reduced if you are using another Micro Memory Card.
OBs	See the Instruction List
• Size	Max. 16 KB
• Number of free-cycle OBs	1 (OB 1)
• Number of time-of-day interrupt OBs	1 (OB 10)
• Number of time-delay interrupt OBs	1 (OB 20)
• Number of watchdog interrupts	1 (OB 35)
• Number of process interrupt OBs	1 (OB 40)

Technical data	
• Number of startup OBs	1 (OB 100)
• Number of asynchronous error OBs	4 (OB 80, 82, 85, 87)
• Number of synchronous error OBs	2 (OB 121, 122)
Nesting depth	
• Per priority class	8
• Additional within an error OB	4
FBs	
• Number, max.	1024 (in the 0 to 2047 range of numbers)
• Size	Max. 16 KB
FCs	
• Number, max.	1024 (in the 0 to 2047 range of numbers)
• Size	Max. 16 KB
Address areas (I/O)	
Total I/O address area	
• Inputs	1024 bytes (user-specific addressing)
• Outputs	1024 bytes (user-specific addressing)
I/O process image	
• Inputs	128 bytes
• Outputs	128 bytes
Digital channels	
• Inputs	Max. 256
• Outputs	Max. 256
• Inputs, central	Max. 256
• Outputs, central	Max. 256
Analog channels	
• Inputs	Max. 64
• Outputs	Max. 64
• Inputs, central	Max. 64
• Outputs, central	Max. 64
Removal	
Racks	Max. 1
Modules per rack	Max. 8
Number of DP masters	
• Integrated	None
• Via CP	4
Operable function modules and communication processors	

Technical data	
• FM	Max. 8
• CP (PtP)	Max. 8
• CP (LAN)	Max. 4
Time	
Clock	Yes (SW clock)
• Buffered	No
• Accuracy	Deviation per day < 15 s
• Behavior of the realtime clock after POWER ON	The clock keeps running, continuing at the time-of-day it had when power was switched off.
Operating hours counter	1
• Number	0
• Range of values	2 ³¹ (if SFC 101 is used)
• Granularity	1 hour
• Retentive	Yes; must be manually restarted after every restart
Clock synchronization	Yes
• In the AS	Master
• On MPI	Master/slave
S7 message functions	
Number of stations that can be logged on for signaling functions	6 (depends on the number of connections configured for PG / OP and S7 basic communication)
Process diagnostics messages	Yes
• Simultaneously enabled interrupt S blocks	Max. 20
Test and startup functions	
Status/control variables	Yes
• Variable	Inputs, outputs, memory bits, DBs, timers, counters
• Number of variables	30
– Of those as status variable	30
– Of those as control variable	14
Force	Yes
• Variable	Inputs, outputs
• Number of variables	Max. 10
Block status	Yes
Single-step	Yes
Breakpoint	2
Diagnostics buffer	Yes
• Number of entries (not configurable)	Max. 100

Technical data	
Communication functions	
PG/OP communication	Yes
Global data communication	Yes
• Number of GD circuits	4
• Number of GD packets	Max. 4
– Sending stations	Max. 4
– Receiving stations	Max. 4
• Length of GD packets	Max. 22 bytes
– Consistent data	22 bytes
S7 basic communication	Yes
• User data per job	Max. 76 bytes
– Consistent data	76 bytes (for X_SEND or X_RCV) 64 bytes (for X_PUT or X_GET as the server)
S7 communication	
• As server	Yes
• User data per job	Max. 180 bytes (with PUT/GET)
– Consistent data	64 bytes
S5-compatible communication	Yes (via CP and loadable FCs)
Number of connections	Max. 6
can be used for	
• PG communication	Max. 5
– Reserved (default)	1
– Configurable	from 1 to 5
• OP communication	Max. 5
– Reserved (default)	1
– Configurable	from 1 to 5
• S7-based communication	Max. 2
– Reserved (default)	0
– Configurable	from 0 to 2
Routing	No
Interfaces	
1st interface	
Type of interface	Integrated RS485 interface
Physics	RS 485
Electrically isolated	No
Interface power supply (15 to 30 VDC)	Max. 200 mA
Functionality	
• MPI	Yes
• PROFIBUS DP	No
• Point-to-point connection	No

Technical data	
MPI	
Services	
• PG/OP communication	Yes
• Routing	No
• Global data communication	Yes
• S7 basic communication	Yes
• S7 communication	
– As server	Yes
– As client	No
• Transmission rates	187.5 kbps
Programming	
Programming language	LAD/FBD/STL
Instruction set	See the Instruction List
Nesting levels	8
System functions (SFC)	See the Instruction List
System function blocks (SFB)	See the Instruction List
User program protection	Yes
Dimensions	
Mounting dimensions W x H x D (mm)	40 x 125 x 130
Weight	270 g
Voltages and currents	
Power supply (rated value)	24 VDC
• Permissible range	20.4 V to 28.8 V
Current consumption (no-load operation)	Typically 60 mA
Inrush current	Typically 2.5 A
Power consumption (nominal value)	0.6 A
I ² t	0.5 A ² s
External fusing of power supply lines (recommended)	min. 2 A
Power loss	Typically 2.5 W

8.3 CPU 314

Technical data for the CPU 314

Table 8- 4 Technical data for the CPU 314

Technical data	
CPU and version	
Order no. [MLFB]	6ES7314-1AG13-0AB0
• Hardware version	01
• Firmware version	V2.6
• Associated programming package	STEP 7 V 5.4 + SP 3 and higher or STEP 7 V 5.2 + SP1 and higher with HSP 0124
Memory	
Main memory	
• Integrated	96 KB
• Expandable	No
Capacity of the retentive memory for retentive data blocks	64 KB
Load memory	Pluggable by means of Micro Memory Card (max. 8 MB)
Data storage life on the Micro Memory Card (following final programming)	At least 10 years
Buffering	Guaranteed by Micro Memory Card (maintenance-free)
Execution times	
Processing times of	
• Bit operations	Min. 0.1 µs
• Word instructions	Min. 0.2 µs
• Fixed-point arithmetic	Min. 2.0 µs
• Floating-point arithmetic	Min. 3 µs
Timers/counters and their retentive address areas	
S7 counters	256
• Retentivity	Configurable
• Default	From C0 to C7
• Counting range	0 to 999
IEC counters	Yes
• Type	SFB
• Number	unlimited (limited only by work memory size)

Technical data	
S7 timers	256
• Retentivity	Configurable
• Default	Not retentive
• Timer range	10 ms to 9990 s
IEC timers	Yes
• Type	SFB
• Number	unlimited (limited only by work memory size)
Data areas and their retentive address areas	
Bit memory	256 bytes
• Retentivity	Yes
• Preset retentive address areas	MB0 to MB15
Clock flag bits	8 (1 memory byte)
Data blocks	
• Number	511 (in the 1 to 511 range of numbers)
• Size	16 KB
• Non-retentive	Yes
Local data per priority class	Max. 510
Blocks	
Total	1024 (DBs, FCs, FBs) The maximum number of blocks that can be loaded may be reduced if you are using another Micro Memory Card.
OBs	See the Instruction List
• Size	16 KB
• Number of free-cycle OBs	1 (OB 1)
• Number of time-of-day interrupt OBs	1 (OB 10)
• Number of time-delay interrupt OBs	1 (OB 20)
• Number of watchdog interrupts	1 (OB 35)
• Number of process interrupt OBs	1 (OB 40)
• Number of startup OBs	1 (OB 100)
• Number of asynchronous error OBs	4 (OB 80, 82, 85, 87)
• Number of synchronous error OBs	2 (OB 121, 122)
Nesting depth	
• Per priority class	8
• Additional within an error OB	4
FBs	See the Instruction List
• Number, max.	1024 (in the 0 to 2047 range of numbers)
• Size	16 KB

Technical data	
FCs	See the Instruction List
<ul style="list-style-type: none"> • Number, max. 	1024 (in the 0 to 2047 range of numbers)
<ul style="list-style-type: none"> • Size 	16 KB
Address areas (I/O)	
Total I/O address area	
<ul style="list-style-type: none"> • Inputs 	1024 bytes (user-specific addressing)
<ul style="list-style-type: none"> • Outputs 	1024 bytes (user-specific addressing)
I/O process image	
<ul style="list-style-type: none"> • Inputs 	128 bytes
<ul style="list-style-type: none"> • Outputs 	128 bytes
Digital channels	
<ul style="list-style-type: none"> • Inputs 	Max. 1024
<ul style="list-style-type: none"> • Outputs 	Max. 1024
<ul style="list-style-type: none"> • Inputs, central 	Max. 1024
<ul style="list-style-type: none"> • Outputs, central 	Max. 1024
Analog channels	
<ul style="list-style-type: none"> • Inputs 	Max. 256
<ul style="list-style-type: none"> • Outputs 	Max. 256
<ul style="list-style-type: none"> • Inputs, central 	Max. 256
<ul style="list-style-type: none"> • Outputs, central 	Max. 256
Removal	
Racks	Max. 4
Modules per rack	8
Number of DP masters	
<ul style="list-style-type: none"> • Integrated 	None
<ul style="list-style-type: none"> • via CP 	4
Operable function modules and communication processors	
<ul style="list-style-type: none"> • FM 	Max. 8
<ul style="list-style-type: none"> • CP (PtP) 	Max. 8
<ul style="list-style-type: none"> • CP (LAN) 	Max. 10
Time	
Clock	Yes (HW clock)
<ul style="list-style-type: none"> • Buffered 	Yes
<ul style="list-style-type: none"> • Buffered period 	Typically 6 weeks (at an ambient temperature of 40 °C)
<ul style="list-style-type: none"> • Behavior of the clock on expiration of the buffered period 	The clock keeps running, continuing at the time-of-day it had when power was switched off.
<ul style="list-style-type: none"> • Accuracy 	Deviation per day: < 10 s

Technical data	
Operating hours counter	1
• Number	0
• Range of values	2 ³¹ hours (if SFC 101 is used)
• Granularity	1 hour
• Retentive	yes; must be manually restarted after every restart
Clock synchronization	Yes
• In the AS	Master
• On MPI	Master/slave
S7 message functions	
Number of stations that can log in for signaling functions (e.g. OS)	12 (depends on the connections configured for PG / OP and S7 basic communication)
Process diagnostics messages	Yes
• Simultaneously enabled interrupt S blocks	Max. 40
Test and startup functions	
Status/control variables	Yes
• Variable	Inputs, outputs, memory bits, DBs, timers, counters
• Number of variables	30
– Of those as status variable	30
– Of those as control variable	14
Force	Yes
• Variable	Inputs/outputs
• Number of variables	Max. 10
Block status	Yes
Single-step	Yes
Breakpoint	2
Diagnostics buffer	Yes
• Number of entries (not configurable)	Max. 100
Communication functions	
PG/OP communication	Yes
Global Data Communication	Yes
• Number of GD circuits	4
• Number of GD packets	Max. 4
– Sender	Max. 4
– Receiving stations	Max. 4
• Length of GD packets	Max. 22 bytes
– Consistent data	22 bytes

Technical data	
S7 basic communication	Yes
<ul style="list-style-type: none"> • User data per job <ul style="list-style-type: none"> – Consistent data 	Max. 76 bytes 76 bytes (for X_SEND or X_RCV) 64 bytes (for X_PUT or X_GET as the server)
S7 communication	Yes
<ul style="list-style-type: none"> • As server 	Yes
<ul style="list-style-type: none"> • as client 	Yes (via CP and loadable FBs)
<ul style="list-style-type: none"> • User data per job <ul style="list-style-type: none"> – Consistent data 	Max. 180 (for PUT/GET) 64 bytes
S5-compatible communication	Yes (via CP and loadable FCs)
Number of connections	12
can be used for	
<ul style="list-style-type: none"> • PG communication <ul style="list-style-type: none"> – Reserved (default) – Configurable 	Max. 11 1 1 to 11
<ul style="list-style-type: none"> • OP communication <ul style="list-style-type: none"> – Reserved (default) – Configurable 	Max. 11 1 1 to 11
<ul style="list-style-type: none"> • S7-based communication <ul style="list-style-type: none"> – Reserved (default) – Configurable 	Max. 8 0 0 to 8
Routing	No
Interfaces	
1st interface	
Type of interface	Integrated RS485 interface
Physics	RS 485
Electrically isolated	No
Interface power supply (15 to 30 VDC)	Max. 200 mA
Functionality	
<ul style="list-style-type: none"> • MPI 	Yes
<ul style="list-style-type: none"> • PROFIBUS DP 	No
<ul style="list-style-type: none"> • Point-to-point connection 	No

Technical data	
MPI	
Services	
• PG/OP communication	Yes
• Routing	No
• Global data communication	Yes
• S7 basic communication	Yes
• S7 communication	Yes
– As server	Yes
– As client	No (but via CP and loadable FBs)
• Transmission rates	187.5 kbps
Programming	
Programming language	LAD/FBD/STL
Instruction set	See the Instruction List
Nesting levels	8
System functions (SFC)	See the Instruction List
System function blocks (SFB)	See the Instruction List
User program protection	Yes
Dimensions	
Mounting dimensions W x H x D (mm)	40 x 125 x 130
Weight	280 g
Voltages and currents	
Power supply (rated value)	24 VDC
• Permissible range	20.4 V to 28.8 V
Current consumption (no-load operation)	Typically 60 mA
Inrush current	Typically 2.5 A
Power consumption (nominal value)	0.6 A
I ² t	0.5 A ² s
External fusing of power supply lines (recommended)	min. 2 A
Power loss	Typically 2.5 W

8.4 CPU 315-2 DP

Technical data

Table 8- 5 Technical data for the CPU 315-2 DP

Technical data	
CPU and version	
Order no. [MLFB]	6ES7315-2AG10-0AB0
• Hardware version	05
• Firmware version	V2.6
• Associated programming package	STEP 7 V 5.4 + SP 3 and higher or STEP 7 V 5.2 + SP1 and higher with HSP 0125
Memory	
Work memory	
• Integrated	128 KB
• Expandable	No
• Capacity of the retentive memory for retentive data blocks	128 KB
Load memory	Pluggable by means of Micro Memory Card (max. 8 MB)
Data storage life on the Micro Memory Card (following final programming)	At least 10 years
Buffering	Guaranteed by Micro Memory Card (maintenance-free)
Execution times	
Processing times of	
• Bit operations	Min. 0.1 µs
• Word instructions	Min. 0.2 µs
• Fixed-point arithmetic	Min. 2.0 µs
• Floating-point arithmetic	Min. 3 µs
Timers/counters and their retentive address areas	
S7 counters	256
• Retentivity	Configurable
• Default	From C0 to C7
• Counting range	0 to 999
IEC Counters	Yes
• Type	SFB
• Number	unlimited (limited only by work memory size)

Technical data	
S7 timers	256
• Retentivity	Configurable
• Default	Not retentive
• Timer range	10 ms to 9990 s
IEC timers	Yes
• Type	SFB
• Number	unlimited (limited only by work memory size)
Data areas and their retentive address areas	
Bit memory	2048 bytes
• Retentivity	Yes
• Preset retentive address areas	MB0 to MB15
Clock flag bits	8 (1 memory byte)
Data blocks	
• Number	1023 (in the 1 to 1023 range of numbers)
• Size	16 KB
• Non-retain support (configurable retentive address areas)	Yes
Local data capacity	Max. 1024 bytes per execution level/510 bytes per block
Blocks	
Total	1024 (DBs, FCs, FBs) The maximum number of blocks that can be loaded may be reduced if you are using another Micro Memory Card.
OBs	See the Instruction List
• Size	16 KB
• Number of free-cycle OBs	1 (OB 1)
• Number of time-of-day interrupt OBs	1 (OB 10)
• Number of time-delay interrupt OBs	1 (OB 20)
• Number of watchdog interrupts	1 (OB 35)
• Number of process interrupt OBs	1 (OB 40)
• Number of DPV1 interrupt OBs	3 (OB 55, 56, 57)
• Number of startup OBs	1 (OB 100)
• Number of asynchronous error OBs	5 (OB 80, 82, 85, 86, 87)
• Number of synchronous error OBs	2 (OB 121, 122)
Nesting depth	
• Per priority class	8
• Additional within an error OB	4

Technical data	
FBs	See the instruction list
• Number, max.	1024 (in the 0 to 2047 range of numbers)
• Size	16 KB
FCs	See the instruction list
• Number, max.	1024 (in the 0 to 2047 range of numbers)
• Size	16 KB
Address areas (I/O)	
Total I/O address area	
• Inputs	2048 bytes (user-specific addressing)
• Outputs	2048 bytes (user-specific addressing)
• Distributed – Inputs – Outputs	2048 bytes 2048 bytes
Process image	
• Inputs	128
• Outputs	128
Digital channels	
• Inputs	Max. 16384
• Outputs	Max. 16384
• Inputs, central	Max. 1024
• Outputs, central	Max. 1024
Analog channels	
• Inputs	Max. 1024
• Outputs	Max. 1024
• Inputs, central	Max. 256
• Outputs, central	Max. 256
Removal	
Racks	Max. 4
Modules per rack	8
Number of DP masters	
• Integrated	1
• Via CP	4
Operable function modules and communication processors	
• FM	Max. 8
• CP (PtP)	Max. 8
• CP (LAN)	Max. 10

Technical data	
Time	
Clock	Yes (HW clock)
• Buffered	Yes
• Buffered period	Typically 6 weeks (at an ambient temperature of 40 °C)
• Behavior of the clock on expiration of the buffered period	The clock keeps running, continuing at the time-of-day it had when power was switched off.
• Accuracy	Deviation per day: < 10 s
Operating hours counter	1
• Number	0
• Value range	2 ³¹ hours (if SFC 101 is used)
• Granularity	1 hour
• Retentive	Yes; must be manually restarted after every restart
Clock synchronization	Yes
• In the AS	Master
• On MPI	Master/slave
• On DP	Master/slave (only time slave if DP slave)
S7 message functions	
Number of stations that can log in for signaling functions (e.g. OS)	16 (depends on the number of connections configured for PG / OP and S7 basic communication)
Process diagnostics messages	Yes
• Simultaneously enabled interrupt S blocks	40
Test and startup functions	
Status/control variables	Yes
• Variable	Inputs, outputs, memory bits, DBs, timers, counters
• Number of variables	30
– Of those as status variable	30
– Of those as control variable	14
Force	
• Variable	Inputs/outputs
• Number of variables	Max. 10
Block status	Yes
Single-step	Yes
Breakpoint	2
Diagnostics buffer	Yes
• Number of entries (not configurable)	Max. 100

Technical data	
Communication functions	
PG/OP communication	Yes
Global data communication	Yes
• Number of GD circuits	8
• Number of GD packets	max. 8
– Sending stations	Max. 8
– Receiving stations	Max. 8
• Length of GD packets	max. 22 bytes
– Consistent data	22 bytes
S7 basic communication	Yes
• User data per job	Max. 76 bytes
– Consistent data	76 bytes (for X_SEND or X_RCV) 64 bytes (for X_PUT or X_GET as the server)
S7 communication	Yes
• As server	Yes
• As client	Yes (via CP and loadable FBs)
• User data per job	Max. 180 bytes (with PUT/GET)
– Consistent data	64 byte (as the server)
S5-compatible communication	Yes (via CP and loadable FCs)
Number of connections	16
can be used for	
• PG communication	Max. 15
– Reserved (default)	1
– Configurable	1 to 15
• OP communication	Max. 15
– Reserved (default)	1
– Configurable	1 to 15
• S7-based communication	Max. 12
– Reserved (default)	0
– Configurable	0 to 12
Routing	Yes (max. 4)
Interfaces	
1st interface	
Type of interface	Integrated RS485 interface
Physics	RS 485
Electrically isolated	No
Interface power supply (15 to 30 VDC)	Max. 200 mA
Functionality	
• MPI	Yes
• PROFIBUS DP	No
• Point-to-point connection	No

Technical data	
MPI	
Services	
• PG/OP communication	Yes
• Routing	Yes
• Global data communication	Yes
• S7 basic communication	Yes
• S7 communication	Yes
– As server	Yes
– As client	No (but via CP and loadable FBs)
• Transmission rates	187.5 kbps
2nd interface	
Type of interface	Integrated RS485 interface
Physics	RS 485
Electrically isolated	Yes
Type of interface	Integrated RS485 interface
Interface power supply (15 to 30 VDC)	Max. 200 mA
Functionality	
MPI	No
PROFIBUS DP	Yes
Point-to-point connection	No
DP master	
Services	
• PG/OP communication	Yes
• Routing	Yes
• Global data communication	No
• S7 basic communication	Yes (only I blocks)
• S7 communication	Yes (only server; configured unilateral connection)
• Constant bus cycle time	Yes
• Isochronous mode	No
• SYNC/FREEZE	Yes
• DPV1	Yes
• Activate / deactivate DP slaves	Yes
– Max. number of DP slaves that can be activated/deactivated simultaneously	4
Transmission speed	Up to 12 Mbaud
Number of DP slaves per station	124
• Address area	Max. 2 KB I / max. 2 KB O
• User data per DP slave	Max. 244 byte I / Max. 244 byte O

Technical data	
DP slave	
Services	
• PG/OP communication	Yes
• Routing	Yes (only if interface is active)
• Global data communication	No
• S7 basic communication	No
• S7 communication	Yes (only server; configured unilateral connection)
• Direct data exchange	Yes
• Transmission rates	Up to 12 Mbaud
• Automatic baud rate search	Yes (only if interface is passive)
• Intermediate memory	244 bytes I / 244 bytes O
• Address areas	Max. 32, with max. 32 bytes each
• DPV1	No
GSD file	The latest GSD file is available at: http://www.automation.siemens.com/csi/gsd
Programming	
Programming language	LAD/FBD/STL
Instruction set	See the instruction list
Nesting levels	8
System functions (SFC)	See the instruction list
System function blocks (SFB)	See the instruction list
User program protection	Yes
Dimensions	
Mounting dimensions W x H x D (mm)	40 x 125 x 130
Weight	290 g
Voltages and currents	
Power supply (rated value)	24 VDC
• Permissible range	20.4 V to 28.8 V
Current consumption (no-load operation)	Typically 60 mA
Inrush current	Typically 2.5 A
Power consumption (nominal value)	0.8 A
I ² t	0.5 A ² s
External fusing of power supply lines (recommended)	min. 2 A
Power loss	Typically 2.5 W

8.5 CPU 315-2 PN/DP

Technical data

Table 8- 6 Technical data for the CPU 315-2 PN/DP

Technical data	
CPU and version	
Order no. [MLFB]	6ES7315-2EH13-0AB0
• Hardware version	01
• Firmware version	V 2.6
• Associated programming package	STEP 7 as of V 5.4 + SP 2
Memory	
Main memory	
• Work memory	256 KB
• Expandable	No
• Capacity of the retentive memory for retentive data blocks	128 KB
Load memory	Pluggable by means of Micro Memory Card (max. 8 MB)
Buffering	Guaranteed by Micro Memory Card (maintenance-free)
Data storage life on the Micro Memory Card (following final programming)	At least 10 years
Execution times	
Processing times of	
• Bit operations	0.1 µs
• Word instructions	0.2 µs
• Fixed-point arithmetic	2 µs
• Floating-point arithmetic	3 µs
Timers/counters and their retentive address areas	
S7 counters	256
• Retentivity	Configurable
• Default	From C0 to C7
• Counting range	0 to 999
IEC counters	Yes
• Type	SFB
• Number	Unlimited (limited only by work memory)

Technical data	
S7 timers	256
• Retentivity	Settable
• Default	Not retentive
• Timer range	10 ms to 9990 s
IEC timers	Yes
• Type	SFB
• Quantity	Unlimited (limited only by work memory)
Data areas and their retentive address areas	
Bit memory	2048 bytes
• Retentivity	Settable
• Preset retentive address areas	From MB0 to MB15
Clock flag bits	8 (1 memory byte)
Data blocks	
• Number	1023 (in the 1 to 1023 range of numbers)
• Size	16 KB
• Non-retain support (configurable retentive address areas)	Yes
Local data per priority class	Max. 1024 bytes per execution level/510 bytes per block
Blocks	
Total	1024 (DBs, FCs, FBs) The maximum number of blocks that can be loaded may be reduced if you are using another Micro Memory Card.
OBs	See the Instruction List
• Size	16 Kbyte
• Number of free-cycle OBs	1 (OB 1)
• Number of time-of-day interrupt OBs	1 (OB 10)
• Number of time-delay interrupt OBs	1 (OB 20)
• Number of watchdog interrupts	1 (OB35)
• Number of process interrupt OBs	1 (OB 40)
• Number of DPV1 interrupt OBs	3 (OB 55, 56, 57)
• Number of process interrupt OBs	1 (OB61)
• Number of startup OBs	1 (OB 100)
• Number of asynchronous error OBs	6 (OB 80, 82, 83, 85, 86, 87) (OB 83 for PROFINET IO)
• Number of synchronous error OBs	2 (OB 121, 122)

Technical data	
Nesting depth	
• Per priority class	8
• Additional within an error OB	4
FBs	
• Number, max.	1024 (in the 0 to 2047 range of numbers)
• Size	16 Kbyte
FCs	
• Number, max.	1024 (in the number range from 0 to 2047)
• Size	16 Kbyte
Address areas (I/O)	
Total I/O address area	
• Inputs	2048 bytes (user-specific addressing)
• Outputs	2048 bytes (user-specific addressing)
• Distributed – Inputs – Outputs	2048 bytes (user-specific addressing) 2048 bytes (user-specific addressing)
I/O process image	
• Configurable – Inputs – Outputs	2048 bytes 2048 bytes
• Preset – Inputs – Outputs	128 bytes 128 bytes
Number of process image partitions	1
Digital channels	
• Inputs	max. 16384
• Outputs	max. 16384
• Inputs, central	max. 1024
• Outputs, central	max. 1024
Analog channels	
• Inputs	max. 1024
• Outputs	max. 1024
• Inputs, central	max. 256
• Outputs, central	max. 256

Technical data	
Removal	
Racks	max. 4
Modules per rack	8
Number of DP masters	
• Integrated	1
• Via CP	4
Operable function modules and communication processors	
• FM	max. 8
• CP (PtP)	max. 8
• CP (LAN)	max. 10
Time	
Clock	Yes (hardware clock)
• Factory setting	DT#1994-01-01-00:00:00
• Buffered	Yes
• Buffered period	Typically 6 weeks (at an ambient temperature of 40 °C)
• Behavior of the clock on expiration of the buffered period	The clock keeps running, continuing at the time-of-day it had when power was switched off.
• Behavior of the realtime clock after POWER ON	The clock continues running after POWER OFF.
• Precision	Deviation per day: < 10 s
Operating hours counter	1
• Number	0
• Range of values	2 ³¹ hours (if SFC 101 is used)
• Granularity	1 hour
• Retentive	Yes; must be restarted after every restart
Clock synchronization	Yes
• In the AS	Master/slave
• On MPI	Master/slave
• On DP	Master/slave (only time slave if DP slave)
• On Ethernet over NTP	Yes (as client)
S7 message functions	
Number of stations that can be logged on for signaling functions	16 (depends on the number of connections configured for PG / OP and S7 basic communication)
Process diagnostics messages	Yes
• Simultaneously enabled interrupt S blocks	40

Technical data	
Test and startup functions	
Status/control variables	Yes
<ul style="list-style-type: none"> Variable 	Inputs, outputs, memory bits, DBs, timers, counters
<ul style="list-style-type: none"> Number of variables <ul style="list-style-type: none"> Of those as status variable Of those as control variable 	30 Max. 30 Max. 14
Force	
<ul style="list-style-type: none"> Variable 	Inputs/outputs
<ul style="list-style-type: none"> Number of variables 	max. 10
Block status	Yes
Single-step	Yes
Breakpoint	2
Diagnostics buffer	Yes
<ul style="list-style-type: none"> Number of entries (not configurable) 	max. 500
<ul style="list-style-type: none"> POWER OFF / POWER ON 	The last 100 entries are retentive
Communication functions	
Open IE communication	
Number of connections / access points, total	8
TCP/IP	Yes (via integrated PROFINET interface and loadable FBs)
<ul style="list-style-type: none"> Maximum number of connections 	8
<ul style="list-style-type: none"> Data length for connection type 01H, max. 	1460 bytes
<ul style="list-style-type: none"> Data length for connection type 11H, max. 	8192 bytes
ISO on TCP	Yes (via integrated PROFINET interface and loadable FBs)
<ul style="list-style-type: none"> Number of connections, max. 	8
<ul style="list-style-type: none"> Data length, max. 	8192 bytes
UDP	Yes (via integrated PROFINET interface and loadable FBs)
<ul style="list-style-type: none"> Number of connections, max. 	8
<ul style="list-style-type: none"> Data length, max. 	1472 bytes
PG/OP communication	Yes
Global Data Communication	Yes
<ul style="list-style-type: none"> Number of GD circuits 	8
<ul style="list-style-type: none"> Number of GD packets <ul style="list-style-type: none"> Sending stations Receiving stations 	Max. 8 Max. 8 Max. 8
<ul style="list-style-type: none"> Length of GD packets <ul style="list-style-type: none"> Consistent data 	Max. 22 bytes 22 bytes

Technical data	
S7 basic communication	Yes
<ul style="list-style-type: none"> • User data per job <ul style="list-style-type: none"> – Consistent data 	Max. 76 bytes 76 bytes
S7 communication	Yes
<ul style="list-style-type: none"> • As server 	Yes
<ul style="list-style-type: none"> • As client 	Yes (via integrated PN interface and loadable FBs, or even via CP and loadable FBs)
<ul style="list-style-type: none"> • User data per job <ul style="list-style-type: none"> – Consistent data 	See the STEP 7 Online Help, <i>Common parameters of SFBs/FBs and SFC/FC of the S7 communication</i>
S5-compatible communication	Yes (via CP and loadable FCs)
Number of connections	16
can be used for	
<ul style="list-style-type: none"> • PG communication <ul style="list-style-type: none"> – Reserved (default) – Settable 	Max. 15 1 1 to 15
<ul style="list-style-type: none"> • OP communication <ul style="list-style-type: none"> – Reserved (default) – Settable 	Max. 15 1 1 to 15
<ul style="list-style-type: none"> • S7-based communication <ul style="list-style-type: none"> – Reserved (default) – Configurable 	Max. 14 0 0 to 14
Routing	Yes
<ul style="list-style-type: none"> • Interface X1 configured as <ul style="list-style-type: none"> – MPI – DP master – DP slave (active) • Interface X2 configured as PROFINET 	Max. 10 Max. 24 Max. 14 Max. 24
CBA	
Reference setting for CPU communication	50%
Number of remote interconnecting partners	32
Number of master/slave functions	30
Total of all master/slave connections	1000
Data length of all incoming master/slave connections, max.	4000 bytes
Data length of all outgoing master/slave connections, max.	4000 bytes
Number of device-internal and PROFIBUS interconnections	500
Data length of the device-internal and PROFIBUS interconnections, max.	4000 bytes
Data length per connection, max.	1400 bytes

Technical data	
Remote interconnections with acyclical transmission	
• Scan rate: Scan interval, min.	500 ms
• Number of incoming interconnections	100
• Number of outgoing interconnections	100
• Data length of all incoming interconnections, max.	2000 bytes
• Data length of all outgoing interconnections, max.	2000 bytes
• Data length per connection, (acyclic interconnections), max.	1400 bytes
Remote interconnections with cyclical transmission	
• Transmission frequency: Minimum transmission interval	10 ms
• Number of incoming interconnections	200
• Number of outgoing interconnections	200
• Data length of all incoming interconnections, max.	2000 bytes
• Data length of all outgoing interconnections, max.	2000 bytes
• Data length per connection, (acyclic interconnections), max.	450 bytes
HMI variables via PROFINET (acyclic)	
• Update HMI variables	500 ms
• Number of stations that can be logged on for HMI variables (PN OPC/iMAP)	2xPN OPC/1x iMAP
• Number of HMI variables	200
• Data length of all HMI variables, max.	2000 bytes
PROFIBUS proxy functionality	
• supported	Yes
• Number of coupled PROFIBUS devices	16
• Data length per connection, max.	240 bytes (slave dependent)
interfaces	
1st interface	
Type of interface	Integrated RS485 interface
Physics	RS 485
Electrically isolated	Yes
Interface power supply (15 to 30 VDC)	max. 200 mA

Technical data	
Functionality	
• MPI	Yes
• PROFIBUS DP	Yes
• Point-to-point connection	No
• PROFINET	No
MPI	
Services	
• PG/OP communication	Yes
• Routing	Yes
• Global data communication	Yes
• S7 basic communication	Yes
• S7 communication	Yes
– As server	Yes
– As client	No (but via CP and loadable FBs)
• Transmission rates	Max. 12 Mbaud
DP Master	
Services	
• PG/OP communication	Yes
• Routing	Yes
• Global data communication	No
• S7 basic communication	Yes (only I blocks)
• S7 communication	Yes (only server; configured unilateral connection)
• Constant bus cycle time	Yes
• SYNC/FREEZE	Yes
• DPV1	Yes
• Isochronous mode	Yes (OB 61)
• Activation/deactivation of DP slaves	Yes
– Max. number of DP slaves that can be activated/deactivated simultaneously	4
Transmission speed	Up to 12 Mbaud
Number of DP slaves	124
• Address area	max. 2 KB I / max. 2 KB O
• User data per DP slave	Max. 244 bytes I / Max. 244 bytes O
DP slave	
Services	
• Routing	Yes (only if interface is active)
• Global data communication	No
• S7 basic communication	No

Technical data	
• S7 communication	Yes (only server; configured unilateral connection)
• Direct data exchange	Yes
• Transmission rates	Up to 12 Mbaud
• Automatic baud rate search	Yes (only if interface is passive)
• Intermediate memory	244 bytes I / 244 bytes O
• Address areas	Max. 32, with max. 32 bytes each
• DPV1	No
2nd interface	
Type of interface	PROFINET
Physics	Ethernet RJ 45
Isolated	Yes
Autosensing (10/100 Mbaud)	Yes
Functionality	
• PROFINET	Yes
• MPI	No
• PROFIBUS DP	No
• Point-to-point connection	No
Services	
• PG communication	Yes
• OP communication	Yes
• S7 communication – Max. configurable interconnections – Maximum number of instances	Yes (with loadable FBs) 14 32
• Routing	Yes
• PROFINET IO	Yes
• PROFINET CBA	Yes
• Open IE communication – via TCP/IP – ISO on TCP – UDP	Yes Yes Yes
• Web server – Number of http clients	Yes 5
PROFINET IO	
Number of integrated PROFINET IO controllers	1
Number of connectable PROFINET IO devices	128
• Activate / deactivate PROFINET IO devices – Max. number of IO devices that can be activated/deactivated simultaneously	Yes 4
Max. user data consistency with PROFINET IO	256 bytes

Technical data	
Update Time	1 ms to 512 ms The minimum value is determined by the set communication portion for PROFINET IO, the number of IO devices and the amount of configured user data.
Send clock	1 ms
Routing	Yes
S7 protocol functions	
• PG functions	Yes
• OP functions	Yes
• Open IE communication	
– Over TCP/IP	Yes
– ISO on TCP	Yes
– UDP	Yes
GSD file	The latest GSD file is available at: http://www.automation.siemens.com/csi/gsd
CPU/programming	
Programming language	STEP 7 as of V5.3
LAD	Yes
FBD	Yes
STL	Yes
SCL	Yes
CFC	Yes
GRAPH	Yes
HiGraph	Yes
Instruction set	See the Instruction List
Nesting levels	8
System functions (SFC)	See the instruction list
System function blocks (SFB)	See the instruction list
User program protection	Yes
Dimensions	
Mounting dimensions W x H x D (mm)	80 x 125 x 130
Weight	460 g

Technical data	
Voltages, currents	
Power supply (rated value)	24 VDC
• Permitted range	20.4 V to 28.8 V
Current consumption (no-load operation), typically	100 mA
Power consumption (nominal value), typically	650 mA
Inrush current	Typically 2.5 A
I ² t	Min. 1 A ² s
External fusing of power supply lines (recommended)	min. 2 A
Power loss	Typically 3.5 W

8.6 CPU 317-2 DP

Specifications

Table 8-7 Technical data for the CPU 317-2 DP

Technical data	
CPU and version	
Order no. [MLFB]	6ES7317-2AJ10-0AB0
• Hardware version	01
• Firmware version	V 2.6
• Associated programming package	STEP 7 V 5.4 + SP 2 and higher or STEP 7 V 5.2 + SP 1 and higher with HSP 0141
Memory	
Main memory	
• Integrated	512 KB
• Expandable	No
• Capacity of the retentive memory for retentive data blocks	max. 256 KB
Load memory	Pluggable by means of Micro Memory Card (max. 8 MB)
Buffering	Guaranteed by Micro Memory Card (maintenance-free)
Data storage life on the Micro Memory Card (following final programming)	At least 10 years

Technical data	
Execution times	
Processing times of	
• Bit operations	0.05 µs
• Word instructions	0.2 µs
• Fixed-point arithmetic	0.2 µs
• Floating-point arithmetic	1.0 µs
Timers/counters and their retentive address areas	
S7 counters	512
• Retentivity	Configurable
• Default	From C0 to C7
• Counting range	0 to 999
IEC counters	Yes
• Type	SFB
• Number	Unlimited (limited only by working memory)
S7 timers	512
• Retentivity	Configurable
• Default	Not retentive
• Timer range	10 ms to 9990 s
IEC timers	Yes
• Type	SFB
• Number	Unlimited (limited only by working memory)
Data areas and their retentive address areas	
Bit memory	4096 bytes
• Retentivity	Configurable
• Preset retentive address areas	From MB0 to MB15
Clock flag bits	8 (1 memory byte)
Data blocks	
• Number	2047 (in the 1 to 2047 range of numbers)
• Size	64 KB
• Non-retain support (configurable retentive address areas)	Yes
Local data per priority class	max. 1024 bytes

Technical data	
Blocks	
Total	2048 (DBs, FCs, FBs) The maximum number of blocks that can be loaded may be reduced if you are using another Micro Memory Card.
OBs	See the instruction list
• Size	64 KB
• Number of free-cycle OBs	1 (OB 1)
• Number of time-of-day interrupt OBs	1 (OB 10)
• Number of time-delay interrupt OBs	2 (OB 20, 21)
• Number of watchdog interrupts	4 (OB 32, 33, 34, 35)
• Number of process interrupt OBs	1 (OB 40)
• Number of DPV1 interrupt OBs	3 (OB 55, 56, 57)
• Number of process interrupt OBs	1 (OB 61)
• Number of startup OBs	1 (OB 100)
• Number of asynchronous error OBs	5 (OB 80, 82, 85, 86, 87)
• Number of synchronous error OBs	2 (OB 121, 122)
Nesting depth	
• Per priority class	16
• Additional within an error OB	4
FBs	See the instruction list
• Number, max.	2048 (in the 0 to 2047 range of numbers)
• Size	64 KB
FCs	See the instruction list
• Number	2048 (in the 0 to 2047 range of numbers)
• Size	64 KB
Address areas (I/O)	
Total I/O address area	
• Inputs	max. 8192 bytes (user-specific addressing)
• Outputs	max. 8192 bytes (user-specific addressing)
• Distributed	
– Inputs	max. 8192 bytes
– Outputs	max. 8192 bytes

Technical data	
I/O process image	
<ul style="list-style-type: none"> • Configurable <ul style="list-style-type: none"> – Inputs – Outputs 	2048 bytes 2048 bytes
<ul style="list-style-type: none"> • Preset <ul style="list-style-type: none"> – Inputs – Outputs 	256 bytes 256 bytes
Number of process image partitions	1
Digital channels	
• Inputs	max. 65636
• Outputs	max. 65636
• Inputs, central	max. 1024
• Outputs, central	max. 1024
Analog channels	
• Inputs	max. 4096
• Outputs	max. 4096
• Inputs, central	max. 256
• Outputs, central	max. 256
Removal	
Racks	max. 4
Modules per rack	8
Number of DP masters	
• Integrated	2
• Via CP	4
Operable function modules and communication processors	
• FM	max. 8
• CP (PtP)	max. 8
• CP (LAN)	max. 10
Time	
Clock	Yes (HW clock)
• Buffered	Yes
• Buffered period	Typically 6 weeks (at an ambient temperature of 40 °C)
• Behavior of the clock on expiration of the buffered period	The clock keeps running, continuing at the time-of-day it had when power was switched off.
• Precision	Deviation per day: < 10 s

Technical data	
Operating hours counter	4
• Number	0 to 3
• Range of values	2 ³¹ hours (if SFC 101 is used)
• Granularity	1 hour
• Retentive	Yes; must be manually restarted after every restart
Clock synchronization	Yes
• In the AS	Master/slave
• On MPI	Master/slave
• On DP	Master/slave (only time slave if DP slave)
S7 message functions	
Number of stations that can be logged on for signaling functions	32 (depends on the number of connections configured for PG / OP and S7 basic communication)
Process diagnostics messages	Yes
• Simultaneously enabled interrupt S blocks	60
Test and startup functions	
Status/control variables	Yes
• Variable	Inputs, outputs, memory bits, DBs, timers, counters
• Number of variables	30
– Of those as status variable	max. 30
– Of those as control variable	max. 14
Force	
• Variable	Inputs/outputs
• Number of variables	max. 10
Block status	Yes
Single-step	Yes
Breakpoint	2
Diagnostics buffer	Yes
• Number of entries (not configurable)	max. 100
Communication functions	
PG/OP communication	Yes
Global Data Communication	Yes
• Number of GD circuits	8
• Number of GD packets	Max. 8
– Sender	Max. 8
– Receiving stations	Max. 8

Technical data	
<ul style="list-style-type: none"> • Length of GD packets <ul style="list-style-type: none"> – Consistent data 	Max. 22 bytes 22 bytes
S7 basic communication	Yes
<ul style="list-style-type: none"> • User data per job <ul style="list-style-type: none"> – Consistent data 	max. 76 bytes 76 bytes (for X_SEND or X_RCV) 76 bytes (for X_PUT or X_GET as the server)
S7 communication	Yes
<ul style="list-style-type: none"> • As server 	Yes
<ul style="list-style-type: none"> • As client 	Yes (via CP and loadable FBs)
<ul style="list-style-type: none"> • User data per job <ul style="list-style-type: none"> – Consistent data 	max. 180 bytes (with PUT/GET) 160 byte (as the server)
S5-compatible communication	Yes (via CP and loadable FCs)
Number of connections	32
Can be used for	
<ul style="list-style-type: none"> • PG communication <ul style="list-style-type: none"> – Reserved (default) – Configurable 	Max. 31 1 1 to 31
<ul style="list-style-type: none"> • OP communication <ul style="list-style-type: none"> – Reserved (default) – Configurable 	Max. 31 1 1 to 31
<ul style="list-style-type: none"> • S7-based communication <ul style="list-style-type: none"> – Reserved (default) – Configurable 	Max. 30 0 0 to 30
Routing	Yes (max. 8)
interfaces	
1st interface	
Type of interface	Integrated RS485 interface
Physics	RS 485
Electrically isolated	Yes
Interface power supply (15 to 30 VDC)	max. 200 mA
Functionality	
<ul style="list-style-type: none"> • MPI 	Yes
<ul style="list-style-type: none"> • PROFIBUS DP 	Yes
<ul style="list-style-type: none"> • Point-to-point connection 	No

Technical data	
MPI	
Services	
• PG/OP communication	Yes
• Routing	Yes
• Global data communication	Yes
• S7 basic communication	Yes
• S7 communication	
– As server	Yes
– As client	No (but via CP and loadable FBs)
• Transmission rates	Max. 12 Mbaud
DP Master	
Services	
• PG/OP communication	Yes
• Routing	Yes
• Global data communication	No
• S7 basic communication	Yes (only I blocks)
• S7 communication	Yes (only server; configured unilateral connection)
• Constant bus cycle time	Yes
• Isochronous mode	No
• Activate/deactivate DP slaves	Yes
– Max. number of DP slaves that can be activated/deactivated simultaneously	4
• SYNC/FREEZE	Yes
• DPV1	Yes
Transmission rate	Up to 12 Mbaud
Number of DP slaves	124
Address area	max. 8 KB I / 8 KB O
User data per DP slave	max. 244 bytes I / 244 bytes O
DP slave (except for DP slave at both interfaces)	
Services	
• Routing	Yes (only if interface is active)
• Global data communication	No
• S7 basic communication	No
• S7 communication	Yes (only server; configured unilateral connection)
• Direct data exchange	Yes
• Transmission rates	Up to 12 Mbaud

Technical data	
• Automatic baud rate search	Yes (only if interface is passive)
• Intermediate memory	244 bytes I / 244 bytes O
• Address areas	max. 32, max. 32 bytes each
• DPV1	No
2nd interface	
Type of interface	Integrated RS485 interface
Physics	RS 485
Electrically isolated	Yes
Type of interface	Integrated RS485 interface
Interface power supply (15 to 30 VDC)	max. 200 mA
Functionality	
MPI	No
PROFIBUS DP	Yes
Point-to-point connection	No
DP Master	
Services	
• PG/OP communication	Yes
• Routing	Yes
• Global data communication	No
• S7 basic communication	Yes (only I blocks)
• S7 communication	Yes (only server; configured unilateral connection)
• Constant bus cycle time	Yes
• Isochronous mode	Yes (OB61)
• Activate/deactivate DP slaves – Max. number of DP slaves that can be activated/deactivated simultaneously	Yes 4
• SYNC/FREEZE	Yes
• DPV1	Yes
Transmission rate	Up to 12 Mbps
Number of DP slaves	124
Address area	max. 8 KB I / 8 KB O
User data per DP slave	max. 244 bytes I / 244 bytes O

Technical data	
DP slave (except for DP slave at both interfaces)	
Services	
• PG/OP communication	Yes
• Routing	Yes (only if interface is active)
• Global data communication	No
• S7 basic communication	No
• S7 communication	Yes (only server; configured unilateral connection)
• Direct data exchange	Yes
• Transmission rates	Up to 12 Mbps
• Automatic baud rate search	Yes (only if interface is passive)
• Intermediate memory	244 bytes I / 244 bytes O
• Address areas	max. 32, max. 32 bytes each
• DPV1	No
GSD file	The latest GSD file is available at: http://www.automation.siemens.com/csi/gsd
Programming	
Programming language	LAD/FBD/STL
Instruction set	See the instruction list
Nesting levels	8
System functions (SFC)	See the instruction list
System function blocks (SFB)	See the instruction list
User program protection	Yes
Dimensions	
Mounting dimensions W x H x D (mm)	80 x 125 x 130
Weight	460 g
Voltages, currents	
Power supply (rated value)	24 VDC
• Permitted range	20.4 V to 28.8 V
Current consumption (no-load operation), typically	Typically 100 mA
Power consumption (nominal value), typically	850 mA
Inrush current	Typically 2.5 A
I^2t	1 A ² s
External fusing of power supply lines (recommended)	min. 2 A
Power loss	Typically 4 W

8.7 CPU 317-2 PN/DP

Technical data

Table 8- 8 Technical data for the CPU 317-2 PN/DP

Technical data	
CPU and version	
Order no. [MLFB]	6ES7317-2EK13-0AB0
• Hardware version	01
• Firmware version	V 2.6
• Associated programming package	STEP 7 V 5.4 + SP2 and higher
Memory	
Work memory	
• Work memory	1024 KB
• Expandable	No
• Capacity of the retentive memory for retentive data blocks	256 KB
Load memory	Pluggable by means of Micro Memory Card (max. 8 MB)
Buffering	Guaranteed by Micro Memory Card (maintenance-free)
Data storage life on the Micro Memory Card (following final programming)	At least 10 years
Execution times	
Processing times of	
• Bit operations	0.05 μ s
• Word instructions	0.2 μ s
• Fixed-point arithmetic	0.2 μ s
• Floating-point arithmetic	1.0 μ s
Timers/counters and their retentive address areas	
S7 counters	512
• Retentivity	Configurable
• Default	From C0 to C7
• Counting range	0 to 999
IEC counters	Yes
• Type	SFB
• Number	Unlimited (limited only by working memory)

Technical data	
S7 timers	512
• Retentivity	Configurable
• Default	Not retentive
• Timer range	10 ms to 9990 s
IEC timers	Yes
• Type	SFB
• Number	Unlimited (limited only by work memory)
Data areas and their retentive address areas	
Bit memory	4096 bytes
• Retentivity	Configurable
• Preset retentive address areas	From MB0 to MB15
Clock flag bits	8 (1 memory byte)
Data blocks	
• Number	2047 (in the 1 to 2047 range of numbers)
• Size	64 KB
• Non-retain support (configurable retentive address areas)	Yes
Local data per priority class	max. 1024 bytes
Blocks	
Total	2048 (DBs, FCs, FBs) The maximum number of blocks that can be loaded may be reduced if you are using another Micro Memory Card.
OBs	See the Instruction List
• Size	64 KB
• Number of free-cycle OBs	1 (OB 1)
• Number of time-of-day interrupt OBs	1 (OB 10)
• Number of time-delay interrupt OBs	2 (OB 20, 21)
• Number of watchdog interrupts	4 (OB 32, 33, 34, 35)
• Number of process interrupt OBs	1 (OB 40)
• Number of DPV1 interrupt OBs	3 (OB 55, 56, 57)
• Number of process interrupt OBs	1 (OB61)
• Number of startup OBs	1 (OB100)
• Number of asynchronous error OBs	6 (OB 80, 82, 83, 85, 86, 87) (OB83 for PROFINET IO)
• Number of synchronous error OBs	2 (OB 121, 122)

Technical data	
Nesting depth	
• Per priority class	16
• Additional within an error OB	4
FBs	
• Number, max.	2048 (in the 0 to 2047 range of numbers)
• Size	64 KB
FCs	
• Number, max.	2048 (in the 0 to 2047 range of numbers)
• Size	64 KB
Address areas (I/O)	
Total I/O address area	
• Inputs	max. 8192 bytes (user-specific addressing)
• Outputs	max. 8192 bytes (user-specific addressing)
• Distributed – Inputs – Outputs	max. 8192 bytes max. 8192 bytes
I/O process image	
• Configurable – Inputs – Outputs	2048 bytes 2048 bytes
• Preset – Inputs – Outputs	256 bytes 256 bytes
Number of process image partitions	1
Digital channels	
• Inputs	max. 65536
• Outputs	max. 65536
• Inputs, central	max. 1024
• Outputs, central	max. 1024
Analog channels	
• Inputs	max. 4096
• Outputs	max. 4096
• Inputs, central	max. 256
• Outputs, central	max. 256

Technical data	
Removal	
Racks	max. 4
Modules per rack	8
Number of DP masters	
• Integrated	1
• Via CP	4
Operable function modules and communication processors	
• FM	max. 8
• CP (PtP)	max. 8
• CP (LAN)	max. 10
Time	
Clock	Yes (hardware clock)
• Factory setting	DT#1994-01-01-00:00:00
• Buffered	Yes
• Buffered period	Typically 6 weeks (at an ambient temperature of 40 °C)
• Behavior of the clock on expiration of the buffered period	The clock keeps running, continuing at the time-of-day it had when power was switched off.
• Behavior of the realtime clock after POWER ON	The clock continues running after POWER OFF.
• Precision	Deviation per day: < 10 s
Operating hours counter	4
• Number	0 to 3
• Value range	2 ³¹ hours (if SFC 101 is used)
• Granularity	1 hour
• Retentive	Yes; must be manually restarted after every restart
Clock synchronization	Yes
• In the AS	Master/slave
• On MPI	Master/slave
• On DP	Master/slave (only time slave if DP slave)
• On Ethernet via NTP	Yes (as client)
S7 message functions	
Number of stations that can be logged on for signaling functions	32 (depends on the number of connections configured for PG / OP and S7 basic communication)
Process diagnostics messages	Yes
• Simultaneously enabled interrupt S blocks	60

Technical data	
Test and startup functions	
Status/control variables	Yes
<ul style="list-style-type: none"> • Variable 	Inputs, outputs, memory bits, DBs, timers, counters
<ul style="list-style-type: none"> • Number of variables <ul style="list-style-type: none"> – Of those as status variable – Of those as control variable 	30 max. 30 max. 14
Force	
<ul style="list-style-type: none"> • Variable 	Inputs/outputs
<ul style="list-style-type: none"> • Number of variables 	max. 10
Block status	Yes
Single-step	Yes
Breakpoint	2
Diagnostics buffer	Yes
<ul style="list-style-type: none"> • Number of entries (not configurable) 	max. 500
<ul style="list-style-type: none"> • POWER OFF / POWER ON 	The last 100 entries are retentive
Communication functions	
Open IE communication	
Number of connections / access points, total	8
TCP/IP	
Yes (via integrated PROFINET interface and loadable FBs)	
<ul style="list-style-type: none"> • Maximum number of connections 	8
<ul style="list-style-type: none"> • Data length for connection type 01_H, max. 	1460 bytes
<ul style="list-style-type: none"> • Data length for connection type 11_H, max. 	8192 bytes
ISO on TCP	
Yes (via integrated PROFINET interface and loadable FBs)	
<ul style="list-style-type: none"> • Maximum number of connections 	8
<ul style="list-style-type: none"> • Data length, max. 	8192 bytes
UDP	
Yes (via integrated PROFINET interface and loadable FBs)	
<ul style="list-style-type: none"> • Maximum number of connections 	8
<ul style="list-style-type: none"> • Data length, max. 	1472 bytes
PG/OP communication	
Yes	
Global Data Communication	
Yes	
<ul style="list-style-type: none"> • Number of GD circuits 	8
<ul style="list-style-type: none"> • Number of GD packets <ul style="list-style-type: none"> – Sending stations – Receiving stations 	Max. 8 Max. 8 Max. 8
<ul style="list-style-type: none"> • Length of GD packets <ul style="list-style-type: none"> – Consistent data 	Max. 22 bytes 22 bytes

Technical data	
S7 basic communication	Yes
<ul style="list-style-type: none"> • User data per job <ul style="list-style-type: none"> – Consistent data 	Max. 76 bytes 76 bytes
S7 communication	Yes
<ul style="list-style-type: none"> • As server 	Yes
<ul style="list-style-type: none"> • As client 	Yes (via integrated PN interface and loadable FBs, or even via CP and loadable FBs)
<ul style="list-style-type: none"> • User data per job <ul style="list-style-type: none"> – Consistent data 	See the STEP 7 Online Help, <i>Common parameters of SFBs/FBs and SFC/FC of the S7 communication</i>)
S5-compatible communication	Yes (via CP and loadable FCs)
Number of connections	32
can be used for	
<ul style="list-style-type: none"> • PG communication <ul style="list-style-type: none"> – Reserved (default) – Configurable 	Max. 31 1 1 to 31
<ul style="list-style-type: none"> • OP communication <ul style="list-style-type: none"> – Reserved (default) – Settable 	Max. 31 1 1 to 31
<ul style="list-style-type: none"> • S7-based communication <ul style="list-style-type: none"> – Reserved (default) – Settable 	Max. 30 0 0 to 30
Routing	
<ul style="list-style-type: none"> • Interface X1 configured as <ul style="list-style-type: none"> – MPI – DP master – DP slave (active) • Interface X2 configured as <ul style="list-style-type: none"> – PROFINET 	Yes Max. 10 Max. 24 Max. 14 Max. 24
CBA	
Reference setting for CPU communication	50%
Number of remote interconnecting partners	32
Number of master/slave functions	30
Total of all master/slave connections	1000
Data length of all incoming master/slave connections, max.	4000 bytes
Data length of all outgoing master/slave connections, max.	4000 bytes
Number of device-internal and PROFIBUS interconnections	500
Data length of the device-internal and PROFIBUS interconnections, max.	4000 bytes
Data length per connection, max.	1400 bytes

Technical data	
Remote interconnections with acyclic transmission	
• Scan rate: Scan interval, min.	500 ms
• Number of incoming interconnections	100
• Number of outgoing interconnections	100
• Data length of all incoming interconnections, max.	2000 bytes
• Data length of all outgoing interconnections, max.	2000 bytes
• Data length per connection, (acyclic interconnections), max.	1400 bytes
Remote interconnections with cyclical transmission	
• Transmission frequency: Minimum transmission interval	10 ms
• Number of incoming interconnections	200
• Number of outgoing interconnections	200
• Data length of all incoming interconnections, max.	2000 bytes
• Data length of all outgoing interconnections, max.	2000 bytes
• Data length per connection, (acyclic interconnections), max.	450 bytes
HMI variables via PROFINET (acyclic)	
• Update HMI variables	500 ms
• Number of stations that can be logged on for HMI variables (PN OPC/iMAP)	2xPN OPC/1x iMAP
• Number of HMI variables	200
• Data length of all HMI variables, max.	2000 bytes
PROFIBUS proxy functionality	
• supported	Yes
• Number of coupled PROFIBUS devices	16
• Data length per connection, max.	240 bytes (slave dependent)
interfaces	
1st interface	
Type of interface	Integrated RS485 interface
Physics	RS 485
Electrically isolated	Yes
Interface power supply (15 to 30 VDC)	max. 200 mA

Technical data	
Functionality	
• MPI	Yes
• PROFIBUS DP	Yes
• Point-to-point connection	No
• PROFINET	No
MPI	
Services	
• PG/OP communication	Yes
• Routing	Yes
• Global data communication	Yes
• S7 basic communication	Yes
• S7 communication – As server – As client	Yes Yes No (but with CP and loadable FB)
• Transmission rates	Max. 12 Mbaud
DP Master	
Services	
• PG/OP communication	Yes
• Routing	Yes
• Global data communication	No
• S7 basic communication	Yes (only I blocks)
• S7 communication	Yes (only server; configured unilateral connection)
• Constant bus cycle time	Yes
• Isochronous mode	Yes (OB61)
• Activate/deactivate DP slaves – Max. number of DP slaves that can activated/deactivated simultaneously	Yes 4
• SYNC/FREEZE	Yes
• DPV1	Yes
Transmission speed	Up to 12 Mbaud
Number of DP slaves	124
Address area	max. 8 KB I / 8 KB O
User data per DP slave	Max. 244 bytes I / 244 bytes O

Technical data	
DP slave	
Services	
• Routing	Yes (only if interface is active)
• Global data communication	No
• S7 basic communication	No
• S7 communication	Yes (only server; configured unilateral connection)
• Direct data exchange	Yes
• Transmission rates	Up to 12 Mbaud
• Automatic baud rate search	Yes (only if interface is passive)
• Intermediate memory	244 bytes I / 244 bytes O
• Address areas	Max. 32, with max. 32 bytes each
• DPV1	No
2nd interface	
Type of interface	PROFINET
Physics	Ethernet RJ45
Electrically isolated	Yes
Autosensing (10/100 Mbaud)	Yes
Functionality	
• PROFINET	Yes
• MPI	No
• PROFIBUS DP	No
• Point-to-point connection	No
Services	
• PG communication	Yes
• OP communication	Yes
• S7 communication	Yes (with loadable FBs)
– Max. configurable interconnections	16
– Maximum number of instances	32
• Routing	Yes
• PROFINET IO	Yes
• PROFINET CBA	Yes
• Open IE communication	
– via TCP/IP	Yes
– ISO on TCP	Yes
– UDP	Yes
• Web server	Yes
– Number of http clients	5

Technical data	
PROFINET IO	
Number of integrated PROFINET IO controllers	1
Number of connectable PROFINET IO devices	128
<ul style="list-style-type: none"> • Enabling / disabling PROFINET IO devices <ul style="list-style-type: none"> – Max. number of IO devices that can be activated/deactivated simultaneously 	Yes 4
Max. user data consistency with PROFINET IO	256 bytes
Update Time	1 ms to 512 ms The minimum value is determined by the set communication portion for PROFINET IO, the number of IO devices and the amount of configured user data.
Send clock	1 ms
S7 protocol functions	
<ul style="list-style-type: none"> • PG functions 	Yes
<ul style="list-style-type: none"> • OP functions 	Yes
<ul style="list-style-type: none"> • Open IE communication <ul style="list-style-type: none"> – via TCP/IP – ISO on TCP – UDP 	Yes Yes Yes
GSD file	The latest GSD file is available at: http://www.automation.siemens.com/csi/gsd
CPU/programming	
Programming language	STEP 7
LAD	Yes
FBD	Yes
STL	Yes
SCL	Yes
CFC	Yes
GRAPH	Yes
HiGraph	Yes
Instruction set	See the Instruction List
Nesting levels	8
System functions (SFC)	See the instruction list
System function blocks (SFB)	See the instruction list
User program protection	Yes

Technical data	
Dimensions	
Mounting dimensions W x H x D (mm)	80 x 125 x 130
Weight	460 g
Voltages, currents	
Power supply (rated value)	24 VDC
• Permitted range	20.4 V to 28.8 V
Current consumption (no-load operation), typically	100 mA
Power consumption (nominal value), typically	650 mA
Inrush current	Typically 2.5 A
I ² t	Min. 1 A ² s
External fusing of power supply lines (recommended)	min. 2 A
Power loss	Typically 3.5 W

8.8 CPU 319-3 PN/DP

Technical data

Table 8- 9 Technical data for the CPU 319-3 PN/DP

Technical data	
CPU and version	
Order no. [MLFB]	6ES7318-3EL00-0AB0
• Hardware version	01
• Firmware version	V 2.7
• Associated programming package	STEP 7 V 5.4 + SP4 and higher
Memory / backup	
Work memory	
• Work memory, integrated	1400 KB
• Work memory, expandable	No
• Capacity of the retentive memory for retentive data blocks	700 KB
Load memory	Pluggable by means of Micro Memory Card (max. 8 MB)
Data storage life on the Micro Memory Card (following final programming)	At least 10 years
Buffering	Up to 700 Kbytes (maintenance-free)

Technical data	
Execution times	
Processing times of	
• Bit instructions, min.	0.01 µs
• Word instructions, min.	0.02 µs
• Fixed-point arithmetic, min.	0.02 µs
• Floating-point arithmetic, min.	0.04 µs
Timers/counters and their retentive address areas	
S7 counters	
• Number	2048
• Retentive address areas, configurable	Yes
• Retentive address areas, preset	From C0 to C7
• Counting range	0 to 999
IEC Counters	
• Available	Yes
• Type	SFB
• Number	Unlimited (limited only by working memory)
S7 timers	
• Number	2048
• Retentive address areas, configurable	Yes
• Retentive address areas, preset	Not retentive
• Timer range	10 ms to 9990 s
IEC timers	
• Type	SFB
• Number	Unlimited (limited only by work memory)
Data areas and their retentive address areas	
Bit memory	
• Number	8192 bytes
• Retentive address areas, configurable	MB 0 to MB 8191
• Preset retentive address areas	MB 0 to MB15
• Number of clock memories	8 (1 memory byte)
Data blocks	
• Number	4095 (in 1 to 4095 range of numbers)
• Size	64 KB
• Non-retain support (configurable retentive address areas)	Yes
Local data per priority class, max.	1024 bytes

Technical data	
Blocks	
Total number of blocks	4096 (DBs, FCs, FBs) The maximum number of blocks that can be loaded may be reduced if you are using another Micro Memory Card.
Size, max.	64 KB
OBs	See the Instruction List
• Size, max.	64 KB
• Number of free cycle OBs	1 (OB 1)
• Number of time-of-day-interrupt OBs	1 (OB 10)
• Number of delay interrupt OBs	2 (OB 20, 21)
• Number of cyclic interrupt OBs	4 (OB 32, 33, 34, 35) (OB 35: smallest configurable clock = 500 µs)
• Number of process interrupt OBs	1 (OB 40)
• Number of DPV1-interrupt OBs (only DP-CPU)	3 (OB 55, 56, 57)
• Number of synchronous cycle interrupt OBs	1 (OB 61)
• Number of asynchronous error interrupts	6 (OB 80, 82, 83, 85, 86, 87) (OB 83 only for PROFINET IO)
• Number of startup OBs	1 (OB 100)
• Number of synchronous error interrupt OBs	2 (OB 121, 122)
Nesting depth	
• Per priority class	16
• Additional within an error OB	4
FBs	See the Instruction List
• Number, max.	2048 (in the 0 to 2047 range of numbers)
• Size	64 KB
FCs	See the Instruction List
• Max. number 4096)	2048 (in the 0 to 2047 range of numbers)
• Size	64 KB
Address areas (I/O)	
Total I/O address area	
• Inputs	8192 bytes
• Outputs	8192 bytes
• Distributed	
– Inputs	8192 bytes
– Outputs	8192 bytes

Technical data	
I/O process image	
<ul style="list-style-type: none"> • Configurable <ul style="list-style-type: none"> – Inputs – Outputs 	4096 bytes 4096 bytes
<ul style="list-style-type: none"> • Preset <ul style="list-style-type: none"> – Inputs – Outputs 	256 bytes 256 bytes
Number of process image partitions	1
Digital channels	
• Inputs	65536
• Outputs	65536
• Inputs, central	1024
• Outputs, central	1024
Analog channels	
• Inputs	4096
• Outputs	4096
• Inputs, central	256
• Outputs, central	256
Hardware Configuration	
Racks, max.	4
Modules per rack, max.	8
Number of DP masters	
• Integrated	2
• Via CP	4
Number of usable FMs and CPs (recommended)	
• FM	8
• CP, point-to-point	8
• CP, LAN	10
Time	
Clock	
• Hardware clock	Yes
• Buffered	Yes
• Buffered period	Typically 6 weeks (at an ambient temperature of 40 °C)
• Behavior of the clock on expiration of the buffered period	The clock keeps running, continuing at the time-of-day it had when power was switched off.
• Behavior of the realtime clock after POWER ON	The clock continues running after POWER OFF.
• Accuracy	Deviation per day: < 10 s

Technical data	
Operating hours counter	
• Number	4
• Number	0 to 3
• Value range	0 to 2 ³¹ hours (using the SFC 101)
• Granularity	1 hour
• Retentive	Yes; must be manually restarted after every restart
Clock synchronization	
• supported	Yes
• In the AS	Master/slave
• On MPI	Master/slave
• On DP	Master/slave (only time slave if DP slave)
• on Ethernet via NTP	Yes (as client)
S7 message functions	
Number of stations that can be logged on for signaling functions	32 (depends on the number of connections configured for PG / OP and S7 basic communication)
Process diagnostics messages	Yes
• Simultaneously enabled interrupt S blocks	300
Test and startup functions	
Status/control variables	
• Status/control variables	Yes
• Variables	Inputs, outputs, memory bits, DBs, timers, counters
• Maximum number of variables	30
• Number of variables status variables, max.	30
• Number of variables control variables, max.	14
Force	
• Force	Yes
• Force, variables	Inputs/outputs
• Force, maximum number of variables	10
Block status	Yes
Single-step	Yes
Number of breakpoints	2

Technical data	
Diagnostics buffer	
• Available	Yes
• Maximum number of entries	500
• POWER OFF / POWER ON	The last 100 entries are retentive
Communication functions	
Web server	
• Number of http clients	5
Open IE communication	
Number of connections / access points, total	32
TCP/IP	
Yes (via integrated PROFINET interface and loadable FBs)	
• Maximum number of connections	32
• Data length for connection type 01 _H , max.	1460 bytes
• Data length for connection type 11 _H , max.	8192 bytes
ISO on TCP	
Yes (via integrated PROFINET interface and loadable FBs)	
• Maximum number of connections	32
• Data length, max.	8192 bytes
UDP	
Yes (via integrated PROFINET interface and loadable FBs)	
• Maximum number of connections	32
• Data length, max.	1472 bytes
PG/OP communication	
Yes	
Routing	
Yes	
Data set routing	
Yes	
Global data communication	
Yes	
• supported	Yes
• Number of GD circuits, max.	8
• Number of GD packets, max.	8
• Number of GD packets, sender, max.	8
• Number of GD packets, receiver, max.	8
• Size of GD packets, max.	22 bytes
• Size of GD packets, consistent, max.	22 bytes
S7 basic communication	
• supported	Yes
• User data per job, max.	76 bytes
• User data per job, consistent, max.	76 bytes (for X_SEND or X_RCV), 64 bytes (for X_PUT or X_GET as the server)

Technical data	
S7 communication	
• supported	Yes
• As server	Yes
• As client	Yes (via integrated PN interface and loadable FBs, or even via CP and loadable FBs)
• User data per job – Consistent data	See the STEP 7 Online Help, <i>Common parameters of SFBs/FBs and SFC/FC of the S7 communication</i>)
S5compatible communication	
• supported	Yes (via CP and loadable FCs)
Number of connections	
• Total	32
usable for PG communication	
• PG communication, reserved	1
• PG communication, configurable, max.	31
usable for OP communication	
• OP communication, reserved	1
• OP communication, configurable, max.	31
usable for S7 basic communication	
• S7 basic communication, reserved	0
• S7 basic communication, configurable, max.	30
PROFINET CBA	
Reference setting for the CPU communication load	20%
Number of remote interconnecting partners	32
Number of master/slave functions	50
Total of all master/slave connections	3000
Data length of all incoming master/slave connections, max.	24,000 bytes
Data length of all outgoing master/slave connections, max.	24,000 bytes
Number of device-internal and PROFIBUS interconnections	1000
Data length of the device-internal and PROFIBUS interconnections, max.	8000 bytes
Data length per connection, max.	1400 bytes
Remote interconnections with acyclical transmission	
• Scan rate: Scan interval, min.	200 ms
• Number of incoming interconnections	100
• Number of outgoing interconnections	100

Technical data	
• Data length of all incoming interconnections, max.	3200 bytes
• Data length of all outgoing interconnections, max.	3200 bytes
• Data length per connection (acyclic interconnections), max.	1400 bytes
Remote interconnections with cyclical transmission	
• Transmission frequency: Minimum transmission interval	1 ms
• Number of incoming interconnections	300
• Number of outgoing interconnections	300
• Data length of all incoming interconnections, max.	4800 bytes
• Data length of all outgoing interconnections	4800 bytes
• Data length per connection (acyclic interconnections), max.	250 bytes
HMI variables via PROFINET (acyclic)	
• Update HMI variables	500 ms
• Number of stations that can be logged on for HMI variables (PN OPC/iMap)	2xPN OPC / 1x iMap
• Number of HMI variables	600
• Data length of all HMI variables, max.	9600 bytes
PROFIBUS proxy functionality	
• supported	Yes
• Number of coupled PROFIBUS devices	32
• Data length per connection, max.	240 bytes (slave dependent)
interfaces	
1st interface	
Type of interface	Integrated RS485 interface
Physics	RS 485
Electrically isolated	Yes
Interface power supply (15 to 30 VDC)	Max. 150 mA
Functionality	
• MPI	Yes
• DP master	Yes
• DP slave	Yes
• Point-to-point connection	No

Technical data	
MPI	
Services	
• PG/OP communication	Yes
• Routing	Yes
• Global data communication	Yes
• S7 basic communication	Yes
• S7 communication, as server	Yes
• S7 communication, as client	No (but via CP and loadable FBs)
• Transmission rates	Max. 12 Mbits/s
DP master	
Services	
• PG/OP communication	Yes
• Routing	Yes
• Global data communication	No
• S7 basic communication	Yes (only I blocks)
• S7 communication	Yes (only server; configured unilateral connection)
• Constant bus cycle time support	Yes
• Isochronous mode	No
• Activate/deactivate DP slaves – Max. number of DP slaves that can be activated/deactivated simultaneously	Yes 8
• SYNC/FREEZE	Yes
• DPV1	Yes
Transmission speed	Max. 12 Mbits/s
Number of DP slaves	Max. 124
Address area	Max. 8 KB I / 8 KB O
User data per DP slave	Max. 244 bytes I / 244 bytes O
DP slave (except for DP slave at both DP interfaces)	
Services	
• PG/OP communication	Yes
• Routing	Yes (only if interface is active)
• Global data communication	No
• S7 basic communication	No
• S7 communication	Yes (only server; configured unilateral connection)
• Direct data exchange	Yes
• DPV1	No
Transmission rates	Up to 12 Mbits/s
Automatic baud rate search	Yes (only if interface is passive)

Technical data	
Intermediate memory	
• Inputs	244 bytes
• Outputs	244 bytes
Address areas	Max. 32, max. 32 bytes each
2nd interface	
Type of interface	Integrated RS485 interface
Physics	RS 485
Electrically isolated	Yes
Interface power supply (15 to 30 VDC)	Max. 200 mA
Functionality	
MPI	No
DP master	Yes
DP slave	Yes
Point-to-point connection	No
DP master	
Services	
• PG/OP communication	Yes
• Routing	Yes
• Global data communication	No
• S7 basic communication	Yes (only I blocks)
• S7 communication	Yes (only server; configured unilateral connection)
• Constant bus cycle time	Yes
• Isochronous mode	Yes (OB61)
• Activate/deactivate DP slaves – Max. number of DP slaves that can be activated/deactivated simultaneously	Yes 8
• Enable/disable DP slaves	Yes
• SYNC/FREEZE	Yes
• DPV1	Yes
Transmission speed	Up to 12 Mbaud
Number of DP slaves	124
Address area	Max. 8 KB I / 8 KB O
User data per DP slave	Max. 244 bytes I / 244 bytes O
DP slave (except for DP slave at both DP interfaces)	
Services	
• PG/OP communication	Yes
• Routing	Yes (only if interface is active)
• Global data communication	No
• S7 basic communication	No

Technical data	
• S7 communication	Yes (only server; configured unilateral connection)
• Direct data exchange	Yes
• DPV1	No
Transmission rates	Up to 12 Mbaud
Automatic baud rate search	Yes (only if interface is passive)
Intermediate memory	244 bytes I / 244 bytes O
Address areas	Max. 32, with max. 32 bytes each
GSD file	The latest GSD file is available at: http://www.automation.siemens.com/csi/gsd
3rd. interface	
Type of interface	PROFINET
Physics	Ethernet RJ45
Electrically isolated	Yes
Autosensing (10/100 Mbaud)	Yes
Functionality	
• PROFINET	Yes
• MPI	No
• PROFIBUS DP	No
• Point-to-point connection	No
Services	
• PG/OP communication	Yes
• S7 communication	Yes
– Max. configurable interconnections	16
– Maximum number of instances	32
• Routing	Yes
• PROFINET IO	Yes
• PROFINET CBA	Yes
• Open IE communication	Yes
– via TCP/IP	Yes
– ISO on TCP	Yes
– UDP	Yes
– Local port number used at the system end	0, 20, 21, 23, 25, 80, 102, 135, 161, 8080, 34962, 34963, 34964, 65532, 65533, 65534, 65535
• Web server	Yes
– Number of http clients	5

Technical data	
PROFINET IO	
• Number of integrated PROFINET IO controllers	1
• Prioritized startup supported – Max. number of devices with prioritized startup	Yes 32
• Changing IO devices during operation – Max. number of IO devices per docking unit (recommendation, due to max. resources for simultaneous activation / deactivation of IO devices)	Yes 8
• Device replacement without medium change	Yes
• IRT	Yes
• Number of PROFINET IO devices that can be connected – of which RT, max. – of which in line at RT, max. – of which IRT with the option "High flexibility", max. – of which in line at IRT, max.	256 256 256 256 61
• Isochronous mode	No
Activating / deactivating PROFINET IO devices • Max. number of IO devices that can be activated/deactivated simultaneously	Yes 8
Max. user data consistency with PROFINET IO	256 bytes
Send clock	250 µs, 500 µs, 1 ms
Update Time	250 µs to 128 ms (at send clock 250 µs) 500 µs to 256 ms (at send clock 500 µs) 1 ms to 512 ms (at send clock 1 ms) The minimum update time is determined by the time slice set for PROFINET IO communication, by the number of IO devices used, and by the amount of configured user data.
PROFINET CBA	
Acyclic transfer	Yes
Cyclic transfer	Yes
GSD file	The latest GSD file is available at: http://www.automation.siemens.com/csi/gsd
CPU/Programming	
Programming language	STEP 7
LAD	Yes
FBD	Yes
STL	Yes
SCL	Yes
CFC	Yes

Technical data	
GRAPH	Yes
HiGraph	Yes
Instruction set	See the Instruction List
Nesting levels	8
System functions (SFC)	See the Instruction List
System function blocks (SFB)	See the Instruction List
User program protection	Yes
Dimensions	
Mounting dimensions W x H x D (mm)	120 x 125 x 130
Weight	1250 g
Supply voltage	
Power supply (rated value)	24 VDC
• Lower limit of admissible range (DC)	20.4 V
• Upper limit of admissible range (DC)	28.8 V
Voltages and currents	
• External fusing of power supply lines (recommended)	min. 2 A
Current consumption	
• Making current, typically	4 A
• I ² t	1.2 A ² s
• Current consumption (no-load operation), typically	0.4 A
• Power consumption (nominal value), typically	1.05 A
• Power loss, typically	14 W

A

Appendix

A.1 Information about upgrading to a CPU 31xC or CPU 31x

A.1.1 Scope

Who should read this information?

You are already using a CPU from the SIEMENS S7-300 series and now want to upgrade to a new device.

Please note that problems may occur while downloading your user program to the "new" CPU.

If you have used one of the following CPUs in the past ...

CPU	Order number	as of version
		Firmware
CPU 312 IFM	6ES7 312-5AC02-0AB0 6ES7 312-5AC82-0AB0	V1.0.0
CPU 313	6ES7 313-1AD03-0AB0	V1.0.0
CPU 314	6ES7 314-1AE04-0AB0 6ES7 314-1AE84-0AB0	V1.0.0
CPU 314 IFM	6ES7 314-5AE03-0AB0	V1.0.0
CPU 314 IFM	6ES7 314-5AE83-0AB0	V1.0.0
CPU 315	6ES7 315-1AF03-0AB0	V1.0.0
CPU 315-2 DP	6ES7 315-2AF03-0AB0 6ES7 315-2AF83-0AB0	V1.0.0
CPU 316-2 DP	6ES7 316-2AG00-0AB0	V1.0.0
CPU 318-2 DP	6ES7 318-2AJ00-0AB0	V3.0.0

... then please note if you upgrade to one of the following CPUs

CPU	Order number	as of version	Hereafter called
		Firmware	
312	6ES7312-1AE13-0AB0	V2.6	CPU 31xC/31x
312C	6ES7312-5BE03-0AB0	V2.6	
313C	6ES7313-5BF03-0AB0	V2.6	
313C-2 PtP	6ES7313-6BF03-0AB0	V2.6	
313C-2 DP	6ES7313-6CF03-0AB0	V2.6	
314	6ES7314-1AG13-0AB0	V2.6	
314C-2 PtP	6ES7314-6BG03-0AB0	V2.6	
314C-2 DP	6ES7314-6CG03-0AB0	V2.6	
315-2 DP	6ES7315-2AG10-0AB0	V2.6	
315-2 PN/DP	6ES7315-2EH13-0AB0	V2.6	
317-2 DP	6ES7317-2AJ10-0AB0	V2.6	
317-2 PN/DP	6ES7317-2EK13-0AB0	V2.6	
319-3 PN/DP	6ES7318-3EL00-0AB0	V2.7	

Reference

If you intend to migrate from PROFIBUS DP to PROFINET, we also recommend the following manual: *Programming manual From PROFIBUS DP to PROFINET IO*

See also

DPV1 (Page 100)

A.1.2 Changed behavior of certain SFCs

SFC 56, SFC 57 and SFC 13 which work asynchronously

Some of the SFCs that work asynchronously, when used on CPUs 312IFM – 318-2 DP, were always, or under certain conditions, processed after the first call ("quasi-synchronous").

On the 31xC/31x CPUs these SFCs actually run asynchronously. Asynchronous processing may cover multiple OB1 cycles. As a result, a wait loop may turn into an endless loop within an OB.

The following SFCs are affected:

- SFC 56 "WR_DPARM"; SFC 57 "PARM_MOD"

On CPUs 312 IFM to 318-2 DP, these SFCs always work "quasi-synchronously" during communication with centralized I/O modules and always work synchronously during communication with distributed I/O modules.

Note

If you are using SFC 56 "WR_DPARM" or SFC 57 "PARM_MOD", you should always evaluate the SFC's BUSY bit.

- SFC 13 "DPNRM_DG"

On CPUs 312 IFM to 318-2 DP, this SFC always works "quasi synchronously" when it is called in OB82. On CPUs 31xC/31x it generally works asynchronously.

Note

In the user program, the job should merely be started in OB 82. The data should be evaluated in the cyclical program, taking account of the BUSY bits and the value returned in RET_VAL.

Hint

If you are using a CPU 31xC/31x, we recommend that you use SFB 54, rather than SFC 13 "DPNRM_DG".

SFC 20 "BLKMOV"

In the past, this SFC could be used with CPUs 312 IFM to 318-2 DP to copy data from a non runtime-related DB.

SFC 20 no longer has this functionality with CPUs 31xC/31x. SFC83 "READ_DBL" is now used instead.

SFC 54 "RD_DPARM"

This SFC is no longer available on CPUs 31xC/31x. Use SFC 102 "RD_DPARA" instead, which works asynchronously.

SFCs that may return other results

You can ignore the following points if you only use logical addressing in your user program.

When using address conversion in your user program (SFC 5 "GADR_LGC", SFC 49 "LGC_GADR"), you must check the assignment of the slot and logical start address for your DP slaves.

- In the past, the diagnostic address of a DP slave was assigned to the slave's virtual slot 2. Since DPV1 was standardized, this diagnostic address has been assigned to virtual slot 0 (station proxy) for CPUs 31xC/31x.
- If the slave has modeled a separate slot for the interface module (e.g. CPU31x-2 DP as an intelligent slave or IM 153), then its address is assigned to slot 2.

Activating / deactivating DP slaves via SFC 12

With CPUs 31xC/31x, slaves that were deactivated via SFC 12 are no longer automatically activated at the RUN to STOP transition. Now they are not activated until they are restarted (STOP to RUN transition).

A.1.3 Interrupt events from distributed I/Os while the CPU status is in STOP

Interrupt events from distributed I/Os while the CPU status is in STOP

With the new DPV1 functionality (IEC 61158/ EN 50170, volume 2, PROFIBUS), the handling of incoming interrupt events from the distributed I/Os while the CPU status is in STOP has also changed.

Previous response by the CPU with STOP status

With CPUs 312IFM – 318-2 DP, initially an interrupt event was noticed while the CPU was in STOP mode. When the CPU status subsequently returned to RUN, the interrupt was then fetched by an appropriate OB (e.g. OB 82).

New response by the CPU

With CPUs 31xC/31x, an interrupt event (process or diagnostic interrupt, new DPV1 interrupts) is acknowledged by the distributed I/O while the CPU is still in STOP status, and is entered in the diagnostic buffer if necessary (diagnostic interrupts only). When the CPU status subsequently returns to RUN, the interrupt is no longer fetched by the OB. Possible slave faults can be read using suitable SSL queries (e.g. read SSL 0x692 via SFC51).

A.1.4 Runtimes that change while the program is running

Runtimes that change while the program is running

If you have created a user program that has been fine-tuned in relation to certain processing times, please note the following points if you are using a CPU 31xC/31x:

- the program will run much faster on the CPU 31xC/31x.
- Functions that require MMC access (e.g. system start-up time, program download in RUN, return of DP station, etc), may sometimes run slower on the CPU 31xC/31x.

A.1.5 Converting the diagnostic addresses of DP slaves

Converting the diagnostic addresses of DP slaves

If you are using a CPU 31xC/31x with DP interface as the master, please note that you may have to reassign the diagnostic addresses for the slaves since the changes to the DPV1 standard sometimes require two diagnostic addresses per slave.

- The virtual slot 0 has its own address (diagnostic address of the station proxy). The module status data for this slot (read SSL 0xD91 with SFC 51 "RDSYSST") contains IDs that relate to the entire slave/station, e.g., the station error ID. Failure and restoration of the station are also signaled in OB86 on the master via the diagnostic address of the virtual slot 0.
- At some of the slaves the interface module is also modeled as a separate virtual slot (for example, CPU as an intelligent slave or IM153), and a suitable separate address is assigned to virtual slot 2.
The change of operating status is signaled in the master's diagnostic interrupt OB 82 via this address for CPU 31xC-2DP acting as an intelligent slave.

Note

Reading diagnostics data with SFC 13 "DPNRM_DG":

The originally assigned diagnostics address still works. Internally, STEP 7 assigns this address to slot 0.

When using SFC51 "RDSYSST", for example, to read module status information or module rack/station status information, you must also consider the change in slot significance as well as the additional slot 0.

A.1.6 Reusing existing hardware configurations

Reusing existing hardware configurations

If you reuse the configuration of a CPU 312 IFM to 318-2 DP for a CPU 31xC/31x, the CPU 31xC/31x may not run correctly.

If this is the case, you will have to replace the CPU in the STEP 7 hardware configuration editor. When you replace the CPU, STEP 7 will automatically accept all the settings (if appropriate and possible).

A.1.7 Replacing a CPU 31xC/31x

Replacing a CPU 31xC/31x

When supplied, the CPU 31xC/31x adds a connecting plug to the power supply connector.

You no longer need to disconnect the cables of the CPU when you replace a 31xC / 31x CPU. Insert a screwdriver with 3.5 mm blade into the right side of the connector to open the interlock mechanism, then unplug it from the CPU. Once you have replaced the CPU, simply plug the connecting plug back into the power supply connector.

A.1.8 Using consistent data areas in the process image of a DP slave system

Consistent data

For communication in a **DP master system** you can transfer a max. of 128 bytes of consistent data. If you want to transfer IO ranges with the "Complete length" consistency, the following applies for all the CPUs:

- If the address area of consistent data lies **within** the process image, this area is automatically updated. To read and write consistent data, you can also use SFC 14 and SFC 15.
- If the address area of consistent data is **outside** the process image, you have to use the SFCs 14 and 15 to read and write consistent data. Direct access to consistent areas is also possible (e.g. L PEW or T PAW).

A.1.9 Load memory concept for the CPU 31xC/31x

Load memory concept for the CPU 31xC/31x

On CPUs 312 IFM to 318-2 DP, the load memory is integrated into the CPU and may be extended with a memory card,

The load memory of the CPU 31xC/31x is located on the micro memory card (MMC), and is retentive. When blocks are downloaded to the CPU, they are stored on the MMC and cannot be lost even in the event of a power failure or memory reset.

Reference

See also the *Memory concept* chapter in the *CPU Data 31xC and 31x manual*.

Note

User programs can only be downloaded and thus the CPU can only be used if the MMC is inserted.

A.1.10 PG/OP functions

PG/OP functions

With CPUs 315-2 DP (6ES7315-2AFx3-0AB0), 316-2DP and 318-2 DP, PG/OP functions at the DP interface were only possible if the interface was set to active. With CPUs 31xC/31x, these functions are possible at both active and passive interfaces. The performance of the passive interface is considerably lower, however.

A.1.11 Routing for the CPU 31xC/31x as an intelligent slave

Routing for the CPU 31xC/31x as an intelligent slave

If you use the CPU 31xC/31x as an intelligent slave, the routing function can only be used with an actively-configured DP interface.

In the properties of the DP interface in STEP 7, select the "Test, Commissioning, Routing" check box of the "DP-Slave" option.

A.1.12 Changed retentive behavior of CPUs with firmware V2.0.12 or higher

Changed retentive behavior for CPUs with firmware >= V 2.0.12

For data blocks for these CPUs

- you can set the retentive response in the block properties of the DB.
- Using SFC 82 "CREA_DBL" -> Parameter ATTRIB, NON_RETAIN bit, you can specify if the actual values of a DB should be maintained at POWER OFF/ON or STOP-RUN (retentive DB) or if the start values should be read from the load memory (non-retentive DB).

A.1.13 FMs/CPs with separate MPI address in the central rack of a CPU 315-2 PN/DP, a CPU 317 or a CPU 319-3 PN/DP

FMs/CPs with separate MPI address in the central rack of a CPU 315-2 PN/DP / CPU 317 / CPU 319-3 PN/DP

All CPUs except CPU 315-2 PN/DP, CPU 317, CPU 318-2 DP and CPU 319-3 PN/DP	CPU 315-2 PN/DP, CPU 317, CPU 318-2 DP and CPU 319-3 PN/DP
If there are FM/CPs with their own MPI address in the central rack of an S7-300, then they are in the exact same CPU subnet as the CPU MPI station.	If there are FM/CPs with their own MPI address in the central rack of an S7-300, then the CPU forms its own communication bus via the backplane bus with these FM/CPs, which are separated from the other subnets. The MPI address of such an FM/CP is no longer relevant for the stations on other subnets. The communication to the FM/CP is made via the MPI address of the CPU.

When exchanging your existing CPU with a CPU 315-2 PN/DP / CPU 317 / CPU 319-3 PN/DP, you therefore need to

- replace the CPU in your STEP 7 project with the CPU 315-2 PN/DP / CPU 317 / CPU 319-3 PN/DP
- Reconfigure the OPs. The control and the destination address must be reassigned (= the MPI address of the CPU 315-2 PN/DP / CPU 317 / CPU 319-3 PN/DP and the slot of the respective FM)
- Reconfigure the project data for FM/CP to be loaded to the CPU.

This is required for the FM/CP in this rack to remain "available" to the OP/PG.

A.1.14 Using loadable blocks for S7 communication for the integrated PROFINET interface

If you have already used S7 communication via CP with loadable FBs (FB 8, FB 9, FB 12 – FB 15 and FC 62 with version V1.0) from the SIMATIC_NET_CP STEP 7 library (these blocks all feature the family type CP300 PBK) and now want to use the integrated PROFINET interface for S7 communication, you must use the corresponding blocks from the Standard Library\Communication Blocks STEP 7 library in your program (the corresponding blocks FB 8, FB 9, FB 12 – FB 15 and FC 62 have at least version V1.1 and family type CPU_300).

Procedure

1. Download and overwrite the old FBs/FCs in your program container with the corresponding blocks from the standard library.
2. Update the corresponding block calls, including updating the instance DBs, in your user program.

Glossary

Accumulator

Accumulators represent CPU register and are used as buffer memory for download, transfer, comparison, calculation and conversion operations.

Address

An address is the identifier of a specific address or address area. Examples: Input I 12.1; Flag Word MW 25; Data Block DB 3.

Analog module

Analog modules convert process values (e.g. temperature) into digital values which can be processing in the CPU, or they convert digital values into analog manipulated variables.

ASIC

ASIC is the acronym for Application Specific Integrated Circuits.

PROFINET ASICs are components with a wide range of functions for the development of your own devices. They implement the requirements of the PROFINET standard in a circuit and allow extremely high packing densities and performance.

Because PROFINET is an open standard, SIMATIC NET offers PROFINET ASICs for the development of your old devices under the name ERTEC.

Backplane bus

The backplane bus is a serial data bus. It supplies power to the modules and is also used by the modules to communicate with each other. Bus connectors interconnect the modules.

Backup memory

Backup memory ensures buffering of the memory areas of a CPU without backup battery. It backs up a configurable number of timers, counters, flag bits, data bytes and retentive timers, counters, flag bits and data bytes).

Bit memory

Flag bits are part of the CPU's system memory. They store intermediate results of calculations. They can be accessed in bit, word or dword operations.

See System memory

Bus

A bus is a communication medium connecting several nodes. Data can be transferred via serial or parallel circuits, that is, via electrical conductors or fiber optic.

Bus segment

A bus segment is a self-contained section of a serial bus system. Bus segments are interconnected by way of repeaters, for example, in PROFIBUS DP.

Changing IO devices during operation (changing partner ports)

Functionality of a PROFINET device. A PROFINET device that supports this function can communicate during operation with changing communication partners at the same port.

Clock flag bits

flag bit which can be used to generate clock pulses in the user program (1 byte per flag bit).

Note

When operating with S7-300 CPUs, make sure that the byte of the clock memory bit is not overwritten in the user program!

Code block

A SIMATIC S7 code block contains part of the **STEP 7** user program. (in contrast to a DB: this contains only data.)

Code block

→ *Global data*

Code block

→ *Nesting depth*

Component-based automation

→ *PROFINET CBA*

Compress

The PG online function "Compress" is used to rearrange all valid blocks in CPU RAM in a contiguous area of load memory, starting at the lowest address. This eliminates fragmentation which occurs when blocks are deleted or edited.

Configuration

Assignment of modules to module racks/slots and (e.g. for signal modules) addresses.

Counter

Counters are part of CPU system memory. The content of "Counter cells" can be modified by **STEP 7** instructions (for example, up/down count.)

See also System memory

Cycle time

The cycle time represents the time a CPU requires for one execution of the user program.

Cyclic interrupt

→ *Interrupt, cyclic interrupt*

Data block

Data blocks (DB) are data areas in the user program which contain user data. There are global data blocks which can be accessed by all code blocks, and instance data blocks which are assigned to a specific FB call.

Data exchange broadcast

→ *Direct data exchange*

Data exchange traffic

→ *Direct data exchange*

Data set routing

Functionality of a module with several network connections. Modules that support this function are able to pass on data of an engineering system (for example parameter data generated by SIMATIC PDM) from a subnetwork such as Ethernet to a field device at the PROFIBUS DP.

Data, static

Static data can only be used within a function block. These data are saved in an instance data block that belongs to a function block. Data stored in an instance data block are retained until the next function block call.

Data, temporary

Temporary data represent local data of a block. They are stored in the L-stack when the block is executed. After the block has been processed, these data are no longer available.

Default router

The default router is the router that is used when data must be forwarded to a partner located within the same subnet.

In STEP 7, the default router is named *Router*. STEP 7 assigns the local IP address to the default router.

Determinism

→ *Real Time*

Device

Within the context of PROFINET, "device" is the generic term for:

- Automation systems,
- Field devices (for example, PLC, PC),
- Active network components (for example, distributed I/O, valve blocks, drives),
- hydraulic devices and
- pneumatic devices.

The main characteristic of a device is its integration in PROFINET communication over Ethernet or PROFIBUS.

The following device types are distinguished based on their attachment to the bus:

- PROFINET devices
- PROFIBUS devices

Device

→ *PROFIBUS device*

Device

→ *PROFINET device*

Device Name

Before an IO device can be addressed by an IO controller, it must have a device name. In PROFINET, this method was selected because it is simpler to work with names than with complex IP addresses.

The assignment of a device name for a concrete IO device can be compared with setting the PROFIBUS address of a DP slave.

When it ships, an IO device does not have a device name. An IO device can only be addressed by an IO controller, for example for the transfer of project engineering data (including the IP address) during startup or for user data exchange in cyclic operation, after it has been assigned a device name with the PG/PC .

Device replacement without medium change

IO devices having this function can be replaced simply:

- A removable medium (such as Micro Memory Card) with the stored device name is not required.
- The device name does not have to be assigned using the programming device. The inserted IO device receives the device name from the IO controller, not from the removable medium or from the programming device. The IO controller uses the configured topology and the neighboring relationships determined by the IO devices to this purpose. The configured setpoint topology must agree with the actual topology.
- In case of a part being replaced, an IO device already in operation has to be reset to the state of delivery using "Reset to factory setting".

Diagnostic interrupt

Modules capable of diagnostics operations report detected system errors to the CPU by means of diagnostic interrupts.

Diagnostics buffer

The diagnostics buffer represents a buffered memory area in the CPU. It stores diagnostic events in the order of their occurrence.

Direct data exchange

Direct data exchange is a special communication relationship between PROFIBUS DP nodes. Direct data exchange is characterized by PROFIBUS DP nodes that "listen" on the bus and know which data a DP slave returns to its DP master.

DP master

A master which behaves in accordance with EN 50170, Part 3 is known as a DP master.

DP slave

A slave operated on PROFIBUS with PROFIBUS DP protocol and in accordance with EN 50170, Part 3 is referred to as DP slave.

DPV1

The designation DPV1 means extension of the functionality of the acyclical services (to include new interrupts, for example) provided by the DP protocol. The DPV1 functionality has been incorporated into IEC 61158/EN 50170, volume 2, PROFIBUS.

Electrically isolated

The reference potential of the control and on-load power circuits of isolated I/O modules is electrically isolated; for example, by optocouplers, relay contact or transformer. Input/output circuits may be grouped.

Equipotential bonding

Electrical connection (equipotential bonding conductor) which eliminates potential difference between electrical equipment and external conductive bodies by drawing potential to the same or near the same level, in order to prevent disturbing or dangerous voltages between these bodies.

Error display

One of the possible reactions of the operating system to a runtime error is to output an error message. Further reactions: Error reaction in the user program, CPU in STOP.

Error handling via OB

After the operating system has detected a specific error (e.g. access error with **STEP 7**), it calls a dedicated block (Error OB) that determines further CPU actions.

Error response

Reaction to a runtime error. Reactions of the operating system: It sets the automation system to STOP, indicates the error, or calls an OB in which the user can program a reaction.

ERTEC

→ *ASIC*

Fast Ethernet

Fast Ethernet describes the standard with which data is transmitted at 100 Mbps. Fast Ethernet uses the 100 Base-T standard.

FEPRM

→ *Memory Card (MC)*

Flash EPROM

FEPRMs can retain data in the event of power loss, same as electrically erasable EEPROMs. However, they can be erased within a considerably shorter time (FEPRM = Flash Erasable Programmable Read Only Memory). They are used on Memory Cards.

Force

The Force function can be used to assign the variables of a user program or CPU (also: inputs and outputs) constant values.

In this context, please note the limitations listed in the *Overview of the test functions section in the chapter entitled Test functions, Diagnostics and Troubleshooting in the S7-300 Installation manual.*

Functional ground

Grounding which has the sole purpose of safeguarding the intended function of electrical equipment. With functional grounding you short-circuit interference voltage which would otherwise have an unacceptable impact on equipment.

GD circuit

A GD circuit comprises a number of CPUs sharing data by means of global data communication, and is used as follows:

- A CPU broadcasts a GD packet to the other CPUs.
- A CPU sends and receives a GD packet from another CPU.

A GD circuit is identified by a GD circuit number.

GD element

A GD element is generated by assigning shared global data. It is identified by a unique global data ID in the global data table.

GD packet

A GD packet can consist of one or several GD elements transmitted in a single message frame.

Global data

Global data can be addressed from any code block (FC, FB, OB). In particular, this refers to flag bits M, inputs I, outputs Q, timers, counters and data blocks DB. Global data can be accessed via absolute or symbolic addressing.

Global data communication

Global data communication is a method of transferring global data between CPUs (without CFBs).

Ground

The conductive earth whose electrical potential can be set equal to zero at any point.

Ground potential can be different from zero in the area of grounding electrodes. The term reference ground is frequently used to describe this situation.

Ground

The conductive earth whose electrical potential can be set equal to zero at any point.

Ground potential can be different from zero in the area of grounding electrodes. The term reference ground is frequently used to describe this situation.

Ground

The conductive earth whose electrical potential can be set equal to zero at any point.

Ground potential can be different from zero in the area of grounding electrodes. The term reference ground is frequently used to describe this situation.

HART

English: **H**ighway **A**dressable **R**emote **T**ransducer

Industrial Ethernet

→ *Fast Ethernet*

Industrial Ethernet

Industrial Ethernet (formerly SINEC H1) is a technology that allows data to be transmitted free of interference in an industrial environment.

Due to the openness of PROFINET, you can use standard Ethernet components. We recommend, however, that you install PROFINET as Industrial Ethernet.

Instance data block

The **STEP 7** user program assigns an automatically generated DB to every call of a function block. The instance data block stores the values of input, output and in/out parameters, as well as local block data.

Interrupt

The CPU's operating system distinguishes between different priority classes for user program execution. These priority classes include interrupts, e.g. process interrupts. When an interrupt is triggered, the operating system automatically calls an assigned OB. In this OB the user can program the desired response (e.g. in an FB).

Interrupt, cyclic interrupt

A cyclic interrupt is generated periodically by the CPU in a configurable time pattern. A corresponding OB will be processed.

Interrupt, delay

The delay interrupt belongs to one of the priority classes in SIMATIC S7 program processing. It is generated on expiration of a time started in the user program. A corresponding OB will be processed.

Interrupt, delay

→ *Interrupt, delay*

Interrupt, diagnostic

→ *Diagnostic interrupt*

Interrupt, process

→ *Process interrupt*

Interrupt, status

A status interrupt can be generated by a DPV1 slave or a PNIO device respectively. At the DPV1 master or the PNIO controller respectively the receipt of the interrupt causes the OB 55 to be called up.

For detailed information on OB 56, refer to the *Reference Manual System Software for S7-300/400: System and Standard Functions*.

Interrupt, time-of-day

The time-of-day interrupt belongs to one of the priority classes in SIMATIC S7 program processing. It is generated at a specific date (or daily) and time-of-day (e.g. 9:50 or hourly, or every minute). A corresponding OB will be processed.

Interrupt, update

An update interrupt can be generated by a DPV1 slave or a PNIO device respectively. At the DPV1 master or the PNIO controller respectively the receipt of the interrupt causes the OB 56 to be called up.

For detailed information on OB 56, refer to the *Reference Manual System Software for S7-300/400: System and Standard Functions*.

Interrupt, vendor-specific

A vendor-specific interrupt can be generated by a DPV1 slave or a PNIO device respectively. At the DPV1 master or the PNIO controller respectively the receipt of the interrupt causes the OB 57 to be called up.

For detailed information on OB 57, refer to the *Reference Manual System Software for S7-300/400: System and Standard Functions*.

IP address

To allow a PROFINET device to be addressed as a node on Industrial Ethernet, this device also requires an IP address that is unique within the network. The IP address is made up of 4 decimal numbers with a range of values from 0 through 255. The decimal numbers are separated by a period.

The IP address is made up of

- The address of the (subnet) network and
- The address of the node (generally called the host or network node).

IRT

→ *Isochronous Real Time communications*

Isochronous Real Time communications

Synchronized transmission method for the cyclic exchange of IO data between PROFINET devices.

A reserved bandwidth within the send clock is available for the IRT IO data. The reserved bandwidth guarantees that the IRT data can also be transferred even during another high network load (for example TCP/IP communication or additional real time communication) at reserved, synchronized intervals.

LLDP

LLDP (Link Layer Discovery Protocol) is a manufacturer-independent protocol that allows information exchange between neighboring devices. It is defined in accordance with IEEE-802.1AB.

Load memory

This memory contains objects generated by the programming device. Load memory is implemented by means of a plug-in Micro Memory Card of different memory capacities. The SIMATIC Micro Memory Card must be inserted to allow CPU operation.

Load power supply

Power supply to the signal / function modules and the process I/O connected to them.

Local data

→ *Data, temporary*

MAC address

Each PROFINET device is assigned a worldwide unique device identifier in the factory. This 6-byte long device identifier is the MAC address.

The MAC address is divided up as follows:

- 3 bytes vendor identifier and
- 3 bytes device identifier (consecutive number).

The MAC address is normally printed on the front of the device.

Example: 08-00-06-6B-80-C0

Memory Card (MC)

Memory Cards are memory media for CPUs and CPs. They are implemented in the form of RAM or FEPRM. An MC differs from a Micro Memory Card only in its dimensions (MC is approximately the size of a credit card).

Micro Memory Card (MMC)

Micro Memory Cards are memory media for CPUs and CPs. Their only difference to the Memory Card is the smaller size.

Module parameters

Module parameters are values which can be used to configure module behavior. A distinction is made between static and dynamic module parameters.

NCM PC

→ *SIMATIC NCM PC*

Nesting depth

A block can be called from another by means of a block call. Nesting depth is referred to as the number of simultaneously called code blocks.

Network

A network is a larger communication system that allows data exchange between a large number of nodes.

All the subnets together form a network.

Non-isolated

The reference potential of the control and on-load power circuits of non-isolated I/O modules is electrically interconnected.

NTP

The Network Time Protocol (NTP) is a standard for synchronizing clocks in automation systems via Industrial Ethernet. NTP uses the UDP wireless network protocol.

OB priority

The CPU operating system distinguishes between different priority classes, for example, cyclic program execution, process interrupt controlled program processing. Each priority class is assigned organization blocks (OBs) in which the S7 user can program a response. The OBs are assigned different default priority classes. These determine the order in which OBs are executed or interrupt each other when they appear simultaneously.

Operating state

SIMATIC S7 automation systems know the following operating states: STOP, START, RUN.

Parameters

1. Variable of a **STEP 7** code block
2. Variable for declaring module response (one or several per module). All modules have a suitable basic factory setting which can be customized in **STEP 7**. There are static and dynamic parameters.

Parameters, dynamic

Unlike static parameters, you can change dynamic module parameters during runtime by calling an SFC in the user program, e.g. limit values of an analog signal input module.

Parameters, static

Unlike dynamic parameters, static parameters of modules cannot be changed by the user program. You can only modify these parameters by editing your configuration in **STEP 7**, for example, modification of the input delay parameters of a digital signal input module.

PC station

→ *SIMATIC PC station*

PLC

A PLC in the context of SIMATIC S7 --> is a programmable logic controller.

Prioritized startup

The term "prioritized startup" is used for the PROFINET functionality for accelerating the startup of IO devices in a PROFINET IO system with RT and IRT communications.

The function reduces the time that the correspondingly configured IO devices require in order to return to the cyclic user data exchange in the following cases:

- After the power supply has returned
- After a station has come back online
- After IO devices have been activated

Priority class

The S7 CPU operating system provides up to 26 priority classes (or "Program execution levels"). Specific OBs are assigned to these classes. The priority classes determine which OBs interrupt other OBs. Multiple OBs of the same priority class do not interrupt each other. In this case, they are executed sequentially.

Process image

The process image is part of CPU system memory. At the start of cyclic program execution, the signal states at the input modules are written to the process image of the inputs. At the end of cyclic program execution, the signal status of the process image of the outputs is transferred to the output modules.

Process interrupt

A process interrupt is triggered by interrupt-triggering modules as a result of a specific event in the process. The process interrupt is reported to the CPU. The assigned organization block will be processed according to interrupt priority.

Process-Related Function

→ *PROFINET components*

Product version

The product version identifies differences between products which have the same order number. The product version is incremented when forward-compatible functions are enhanced, after production-related modifications (use of new parts/components) and for bug fixes.

PROFIBUS device

→ *Device*

PROFIBUS device

A PROFIBUS node has at least one or more PROFIBUS ports.

A PROFIBUS device cannot take part directly in PROFINET communication but must be included over a PROFIBUS master with a PROFINET port or an Industrial Ethernet/PROFIBUS link (IE/PB Link) with proxy functionality.

PROFINET

Within the framework of Totally Integrated Automation (TIA), PROFINET represents a consequent enhancement of:

- PROFIBUS DP, the established fieldbus and
- Industrial Ethernet, the communication bus for the cell level

Experience gained from both systems was and is being integrated into PROFINET.

PROFINET is an Ethernet-based automation standard of PROFIBUS International (previously PROFIBUS Users Organization e.V.), and defines a multi-vendor communication, automation, and engineering model.

PROFINET ASIC

→ *ASIC*

PROFINET CBA

Within the framework of PROFINET, PROFINET CBA is an automation concept for the implementation of applications with distributed intelligence.

PROFINET CBA lets you create distributed automation solutions, based on default components and partial solutions.

Component Based Automation allows you to use complete technological modules as standardized components in large systems.

The components are also created in an engineering tool which may differ from vendor to vendor. Components of SIMATIC devices are created, for example, with STEP 7.

PROFINET components

A PROFINET component includes the entire data of the hardware configuration, the parameters of the modules, and the corresponding user program. The PROFINET component is made up as follows:

- Technological Function

The (optional) technological (software) function includes the interface to other PROFINET components in the form of interconnectable inputs and outputs.

- Device

The device is the representation of the physical programmable controller or field device including the I/O, sensors and actuators, mechanical parts, and the device firmware.

PROFINET device

→ *Device*

PROFINET device

A PROFINET device always has at least one Industrial Ethernet port. A PROFINET device can also have a PROFIBUS port as a master with proxy functionality.

PROFINET IO

Within the framework of PROFINET, PROFINET IO is a communication concept for the implementation of modular, distributed applications.

PROFINET IO allows you to create automation solutions, which are familiar to you from PROFIBUS.

That is, you have the same application view in STEP 7, regardless of whether you configure PROFINET or PROFIBUS devices.

Proxy

→ *PROFINET device*

Proxy

The PROFINET device with proxy functionality is the substitute for a PROFIBUS device on Ethernet. The proxy functionality allows a PROFIBUS device to communicate not only with its master but also with all nodes on PROFINET.

You can integrate existing PROFIBUS systems into PROFINET communication, for example with the help of an IE/PB Link or a CPU 31x PN/DP. The IE/PB Link then handles communication over PROFINET as a substitute for the PROFIBUS components.

RAM

→ *Memory Card (MC)*

RAM

RAM (Random Access Memory) is a semiconductor read/write memory.

Real Time

Real time means that a system processes external events within a defined time.

Determinism means that a system reacts in a predictable (deterministic) manner.

In industrial networks, both these requirements are important. PROFINET meets these requirements. PROFINET is implemented as a deterministic real-time network as follows:

- The transfer of time-critical data between different stations over a network within a defined interval is guaranteed.
To achieve this, PROFINET provides an optimized communication channel for real-time communication: Real Time (RT).
- An exact prediction of the time at which the data transfer takes place is possible.
- It is guaranteed that problem-free communication using other standard protocols, for example industrial communication for PG/PC can take place within the same network.

Real Time

→ *Real Time*

Reduction factor

The reduction rate determines the send/receive frequency for GD packets on the basis of the CPU cycle.

Reference ground

→ *Ground*

Reference potential

Voltages of participating circuits are referenced to this potential when they are viewed and/or measured.

Restart

On CPU start-up (e.g. after is switched from STOP to RUN mode via selector switch or with POWER ON), OB100 (restart) is initially executed, prior to cyclic program execution (OB1). On restart, the input process image is read in and the **STEP 7** user program is executed, starting at the first instruction in OB1.

Retentive memory

A memory area is considered retentive if its contents are retained even after a power loss and transitions from STOP to RUN. The non-retentive area of memory flag bits, timers and counters is reset following a power failure and a transition from the STOP mode to the RUN mode.

Retentive can be the:

- Bit memory
- S7 timers
- S7 counters
- Data areas

Router

→ *Default router*

Router

→ *Switch*

RT

→ *Real Time*

Runtime error

Errors occurred in the PLC (that is, not in the process itself) during user program execution.

Scan cycle check point

The cycle control point is the section of the CPU program processing in which the process image is updated.

Segment

→ *Bus segment*

Send cycle

Within this interval new data are supplied to an IO device / IO controller in the PROFINET IO system by the IO controller / IO device. The send cycle can be configured separately for each IO device and determines the interval at which data are sent from the IO controller to the IO device (outputs) as well as data from the IO device to the IO controller (inputs).

SIMATIC NCM PC

SIMATIC NCM PC is a version of STEP 7 tailored to PC configuration. For PC stations, it offers the full range of functions of STEP 7.

SIMATIC NCM PC is the central tool with which you configure the communication services for your PC station. The configuration data generated with this tool must be downloaded to the PC station or exported. This makes the PC station ready for communication.

SIMATIC PC station

A "PC station" is a PC with communication modules and software components within a SIMATIC automation solution.

SNMP

SNMP (Simple Network Management Protocol) makes use of the wireless UDP transport protocol. Consists of two network components, similar to the client/server model. The SNMP Manager monitors the network nodes, and the SNMP agents collect the various network-specific information in the individual network nodes and places it in a structured form in the MIB (Management Information Base). This information allows a network management system to run detailed network diagnostics.

STARTUP

A START-UP routine is executed at the transition from STOP to RUN mode. Can be triggered by means of the mode selector switch, or after power on, or by an operator action on the programming device. An S7-300 performs a restart.

Subnet mask

The bits set in the subnet mask decides the part of the IP address that contains the address of the subnet/network.

In general:

- The network address is obtained by an AND operation on the IP address and subnet mask.
- The node address is obtained by an AND NOT operation on the IP address and subnet mask.

Subnetwork

All the devices interconnected by switches are nodes of the same network or subnet. All the devices in a subnet can communicate directly with each other.

All devices in the same subnet have the same subnet mask.

A subnet is physically restricted by a router.

Substitute

→ *Proxy*

Substitute value

Substitute values are configurable values which output modules transfer to the process when the CPU switches to STOP mode.

In the event of an I/O access error, a substitute value can be written to the accumulator instead of the input value which could not be read (SFC 44).

Switch

PROFIBUS is based on a bus topology. Communication nodes are connected by a passive cable - the bus.

In contrast, Industrial Ethernet is made up of point-to-point links: Each communication node is connected directly to one other communication node.

Multiple communication nodes are interconnected at the port of an active network component, that is, at the switch. Other communication nodes (including switches) can then be connected to the other ports of the switch. The connection between a communication node and the switch remains a point-to-point link.

The task of a switch is therefore to regenerate and distribute received signals. The switch "learns" the Ethernet address(es) of a connected PROFINET device or other switches and forwards only the signals intended for the connected PROFINET device or connected switch.

A switch has a certain number of ports. At each port, connect a maximum of one PROFINET device or a further switch.

System memory

System memory is an integrated RAM memory in the CPU. System memory contains the address areas (e.g. timers, counters, flag bits) and data areas that are required internally by the operating system (for example, communication buffers).

System memory

→ *Counter*

System memory

→ *Timers*

Terminating resistor

The terminating resistor is used to avoid reflections on data links.

Timer

→ *Timers*

Timers

Timers are part of CPU system memory. The content of timer cells is automatically updated by the operating system, asynchronously to the user program. **STEP 7** instructions are used to define the precise function of the timer cell (for example, on-delay) and to initiate their execution (for example, start).

TOD interrupt

→ *Interrupt, time-of-day*

Tool changer

→ *Changing IO devices during operation (changing partner ports)*

Transmission rate

Data transfer rate (in bps)

Ungrounded

Having no direct electrical connection to ground

Varistor

Voltage-dependent resistor

Work memory

The working memory is integrated in the CPU and cannot be extended. It is used to run the code and process user program data. Programs only run in the working memory and system memory.

Index

(
(Simple Network Management Protocol), 63

A

Aim of this Documentation, 3

Analog inputs
Configuration, 206
Not connected, 203
Technical data, 215

Analog outputs
Not connected, 203
Technical data, 218

Application
in industrial environments, 154
in residential areas, 154

Application View, 54

Approval
CE, 151
CSA, 152
FM, 153
Marine, 154
UL, 151

Approvals
Standards, 151

Automation concept, 54

B

Blocks, 58
Compatibility, 58
Download, 114
Upload, 115, 116
Burst pulses, 155

C

CE
Approval, 151
Clock synchronization
DP interface, 35, 36
MPI interface, 32, 33
PROFIBUS DP Interface, 35

Communication
Communication protocols, 60
CPU services, 42
Data consistency, 52
Data set routing, 51
Global data communication, 46
Open IE communication, 60
S7 basic communication, 44
S7 communication, 45
Communication load
configured, 131
Dependency of physical cycle time, 132
Influence on the physical cycle time, 132
Communications concept, 54
Component Based Automation, 53, 54
Compression, 116
Configuration
Interrupt inputs, 204
Standard AI, 206
Standard DI, 204
Standard DO, 205
Technological functions, 208
Consistent data, 292
Continuous shock, 159
CPU 312
Technical data, 225
CPU 312C
Technical data, 163, 172
Usage of integrated I/Os, 193
CPU 313C
Technical Data, 170
CPU 313C-2 DP
Technical data, 177
CPU 313C-2 PtP
Technical data, 177
CPU 314
Technical data, 231
CPU 314C-2 DP
Technical data, 185
CPU 314C-2 PtP
Technical Data, 185
CPU 315-2 DP
Technical data, 237
CPU 315-2 PN/DP
Technical data, 244
CPU 317-2 DP
Technical data, 254

- CPU 317-2 PN/DP
 - Technical Data, 263
- CPU 319-3 PN/DP
 - Technical data, 273
- CPU memory reset, 117
- CPUs 31xC
 - Differences, 19
- CSA
 - Approval, 152
- Cycle time
 - Calculation, 127
 - Definition, 124
 - Extension, 126
 - Maximum cycle time, 131
 - Process image, 124
 - Sample calculation, 147
 - Sequence of cyclic program processing, 125
 - Time slice model, 124

D

- Data consistency, 52
- Data set routing, 51
- Definition
 - Electromagnetic Compatibility, 155
- Degree of protection IP 20, 160
- Diagnostics
 - Standard I/O, 210
 - Technological functions, 210
- Differences between the CPUs, 19
- Digital inputs
 - Configuration, 204
 - Technical data, 210
- Digital outputs
 - Configuration, 205
 - Fast, 213
 - Technical data, 213
- Download
 - of blocks, 114
- DP interface
 - Clock synchronization, 35, 36
- DPV1, 100

E

- Electromagnetic Compatibility, 155
- Electrostatic discharge, 155
- EMC, 155
- Emission of radio interference, 156
- Error displays, 29

F

- Firewall, 65
- FM
 - Approval, 153

G

- General technical data, 151
- Global data communication, 46

I

- I/O process image, 109
- Identification code for Australia, 153
- IEC 61131, 154
- Industrial Ethernet, 53
- Information about migration to another CPU, 287
- Insulation test, 160
- Integrated I/Os
 - Usage, 193, 198
- interfaces
 - PROFINET interface:Addressing ports, 38
 - PROFINET interface:Clock synchronization, 37
 - PROFINET interface:Send clock, 39
 - PROFINET interface:Update time, 39
- Interfaces
 - MPI interface, 31
 - MPI interface:Connectable devices, 31
 - PN interface, 37
 - PROFIBUS DP interface, 34
 - PROFIBUS DP interface:Operating modes with two DP interfaces, 34
 - PROFINET interface: Configuring the port properties, 40
 - PROFINET interface:Addressing the ports, 41
 - PROFINET interface:deactivating a port, 40
 - PtP interface, 41
- Interfaces PROFIBUS DP interface
 - Connectable devices, 35
- Interrupt inputs, 209
 - Configuration, 204
- Interrupt response time
 - Calculation, 145
 - Definition, 144
 - of signal modules, 145
 - of the CPUs, 144
 - Process interrupt processing, 145
 - Sample calculation, 150
- Interrupt, delay, 146

L

- Load memory, 103
- Local data, 111
- Longest response time
 - Calculation, 141
 - Conditions, 140

M

- Marine
 - Approval, 154
- Maximum cycle time, 131
- Mechanical environmental conditions, 158
- Memory
 - Compression, 116
- Memory areas
 - Load memory, 103
 - System memory, 104
 - Work memory, 104
- Memory functions
 - Compression, 116
 - CPU memory reset, 117
 - Download of blocks, 114
 - Promming, 116
 - RAM to ROM, 116
 - Restart, 117
 - Uploading blocks, 115, 116
 - Warm start, 117
- Micro Memory Card
 - Micro Memory Card, 112
- Micro Memory Card - Useful life, 113
- Mode selector switch, 19, 22, 24, 26, 28
- MPI, 31
- MPI interface
 - Clock synchronization, 32, 33

N

- Network node, 47

O

- OB83, 59
- OB86, 59
- Organization blocks, 59

P

- PN interface, 37
- Power supply
 - Connection, 19, 22, 24, 26, 28
- Process interrupt processing, 145
- PROFIBUS, 53
- PROFIBUS DP Interface, 34
- PROFIBUS DP Interface
 - Clock synchronization, 35
- PROFIBUS International, 53
- PROFINET, 38, 53
 - Implementation, 53
 - interface, 37
 - Objectives, 53
- PROFINET CBA, 53, 54
- PROFINET IO, 53
- Protection class, 160
- PtP interface, 41
- Pulseshaped disturbance, 155

R

- RAM to ROM, 116
- Required basic knowledge, 3
- Response time
 - Calculating the longest, 141
 - Calculating the shortest, 139
 - Conditions for the longest, 140
 - Conditions for the shortest, 139
 - Definition, 137
 - DP cycle times, 137, 138
 - Factors, 137
 - Fluctuation width, 137
 - Reduction with direct I/O access, 141
 - Sample calculation, 148
- Restart, 117
- Retentive memory, 104
 - Load memory, 104
 - Retentive behavior of memory objects, 106
 - Retentive behavior of the memory objects, 129
 - System memory, 104
- Routing
 - Access to stations on other subnets, 47
 - Example of an application, 50
 - Network node, 47
 - Requirements, 49

S

- S7 basic communication, 44
- S7 communication, 45
- S7 connections
 - Distribution, 97
 - End point, 94
 - of CPUs 31xC, 98
 - Time sequence for allocation, 96
 - Transition point, 94
- Sample calculation
 - of the cycle time, 147
- Sample calculation
 - of the response time, 148
- Sample calculation
 - of interrupt response time, 150
- Scope of this documentation, 9
- Scope of this manual, 3
- Security
 - of the web server, 65
- SFB 52, 58
- SFB 53, 58
- SFB 54, 58
- SFB81, 58
- SFC102, 58
- SFC12, 58
- SFC13, 58
- SFC49, 58
- SFC5, 58
- SFC58, 58
- SFC70, 58
- SFC71, 58
- Shipping conditions, 157
- Shock, 159
- Shortest response time
 - Calculation, 139
 - Conditions, 139
- SIMATIC Micro Memory Card
 - Compatible Micro Memory Cards, 162, 224
 - Properties, 112
 - Slot, 18, 21, 23, 25, 28
- Sinusoidal disturbance, 156
- SNMP, 63
- Standards and approvals, 151
- Status displays, 29
- Storage conditions, 157
- System and standard functions, 58, 59
- System memory, 104, 108
 - I/O process image, 109
 - Local data, 111

T

- Technical data
 - Analog inputs, 215
 - Analog outputs, 218
 - CPU 312, 225
 - CPU 312C, 163
 - CPU 313C, 170
 - CPU 313C-2 DP, 177, 186
 - CPU 313C-2 PtP, 177
 - CPU 314, 231
 - CPU 314C-2 DP, 185
 - CPU 314C-2 PtP, 185
 - CPU 315-2 DP, 237
 - CPU 315-2 PN/DP, 244
 - CPU 317-2 DP, 254
 - CPU 319-3 PN/DP, 273
 - Digital inputs, 210
 - Digital outputs, 213
 - Electromagnetic Compatibility, 155
 - Shipping and storage conditions, 157
- Technical Data
 - CPU 317-2 PN/DP, 263
- Temperature, 157
- Test voltage, 160
- Topology, 86

U

- UL
 - Approval, 151
- Upload, 115, 116
- Useful life of a Micro Memory Card, 113
- User program
 - Upload, 115, 116

V

Vibration, 159

W

Warm start, 117

Watchdog interrupt, 146

Web Access on the CPU, 64, 65

Web server

Activating, 68

Automatic updating, 68, 69

Display classes of the messages, 70

Language selection, 66

Messages, 82

Requirement, 64

Topology, 86

Update status of printout, 70

Update status of the screen content, 70

Web Server

Security, 65

Work memory, 104

