

SIEMENS

SIMATIC HMI

HMI devices MP 377, MP 377 PRO (WinCC flexible)

Operating Instructions

Ordernumber: 6AV6691-1DR01-0AB0

10/2008
A5E01003518-03

Preface	
Overview	1
Safety instructions and approvals	2
Planning application	3
Mounting and connecting	4
Operator controls and displays	5
Configuring the operating system	6
Commissioning a project	7
Operating a project	8
Operating alarms	9
Operating recipes	10
Maintenance and care	11
Technical specifications	12
Appendix	A
Abbreviations	B

Legal information

Warning notice system

This manual contains notices you have to observe in order to ensure your personal safety, as well as to prevent damage to property. The notices referring to your personal safety are highlighted in the manual by a safety alert symbol, notices referring only to property damage have no safety alert symbol. These notices shown below are graded according to the degree of danger.

⚠ DANGER
indicates that death or severe personal injury will result if proper precautions are not taken.
⚠ WARNING
indicates that death or severe personal injury may result if proper precautions are not taken.
⚠ CAUTION
with a safety alert symbol, indicates that minor personal injury can result if proper precautions are not taken.
CAUTION
without a safety alert symbol, indicates that property damage can result if proper precautions are not taken.
NOTICE
indicates that an unintended result or situation can occur if the corresponding information is not taken into account.

If more than one degree of danger is present, the warning notice representing the highest degree of danger will be used. A notice warning of injury to persons with a safety alert symbol may also include a warning relating to property damage.

Qualified Personnel

The device/system may only be set up and used in conjunction with this documentation. Commissioning and operation of a device/system may only be performed by **qualified personnel**. Within the context of the safety notes in this documentation qualified persons are defined as persons who are authorized to commission, ground and label devices, systems and circuits in accordance with established safety practices and standards.

Proper use of Siemens products

Note the following:

⚠ WARNING
Siemens products may only be used for the applications described in the catalog and in the relevant technical documentation. If products and components from other manufacturers are used, these must be recommended or approved by Siemens. Proper transport, storage, installation, assembly, commissioning, operation and maintenance are required to ensure that the products operate safely and without any problems. The permissible ambient conditions must be adhered to. The information in the relevant documentation must be observed.

Trademarks

All names identified by ® are registered trademarks of the Siemens AG. The remaining trademarks in this publication may be trademarks whose use by third parties for their own purposes could violate the rights of the owner.

Disclaimer of Liability

We have reviewed the contents of this publication to ensure consistency with the hardware and software described. Since variance cannot be precluded entirely, we cannot guarantee full consistency. However, the information in this publication is reviewed regularly and any necessary corrections are included in subsequent editions.

Preface

Purpose of the operating instructions

These operating instructions provide information based on the requirements defined by DIN EN 62079 for mechanical engineering documentation. This information relates to the place of use, transport, storage, mounting, use and maintenance.

These operating instructions are intended for:

- Users
- Commissioning engineers
- Maintenance personnel

Read especially the information in the section "Safety instructions" (Page 37).

The help integrated in WinCC flexible, the WinCC flexible Information System, contains detailed information. The information system contains instructions, examples and reference information in electronic form.

Basic knowledge required

General knowledge of automation technology and process communication is needed to understand the operating instructions.

It is also assumed that those using the manual have experience in using personal computers and knowledge of Microsoft operating systems.

Scope of the operating instructions

The operating instructions apply to the following HMI devices in conjunction with the WinCC flexible software package:

- MP 377 12" Touch
- MP 377 12" Key
- MP 377 15" Touch
- MP 377 19" Touch
- MP 377 PRO 15" Touch

Trademarks

The following designations marked with the symbol ® are registered trademarks of Siemens AG:

- HMI®
- SIMATIC®
- WinCC®
- SIMATIC MP 377®

Position in the information landscape

These operating instructions form part of the SIMATIC HMI documentation. You can obtain an overview of SIMATIC hardware and SIMATIC software products and SIMATIC systems and information that can be called up in PDF format in various languages at the following address:

["http://www.automation.siemens.com/simatic/portal/html_76/techdoku.htm"](http://www.automation.siemens.com/simatic/portal/html_76/techdoku.htm)

The following designations are used in these operating instructions to represent multiple HMI devices:

"MP 377" designates all MP 377 HMI devices.

"MP 377 mounting device" designates the following HMI devices:

- MP 377 12" Touch
- MP 377 12" Key
- MP 377 15" Touch
- MP 377 19" Touch

"MP 377 PRO" designates the following HMI devices:

- MP 377 PRO 15" Touch

Conventions

The following text notation will facilitate reading the Operating Instructions:

Notation	Scope
"Add screen"	<ul style="list-style-type: none">• Terms that appear in the user interface, for example, dialog names, tabs, buttons, menu commands• Inputs required, for example limit values, tag values.• Path information
"File > Edit"	Operational sequences, for example, menu commands, shortcut menu commands
<F1>, <Alt+P>	Keyboard operation

Please observe notes labeled as follows:

Note

Notes contain important information concerning the product, its use or a specific section of the documentation to which you should pay particular attention.

Figures in this documentation

This documentation contains figures pertaining to the hardware described herein. Newer versions of the HMI device may differ from these figures.

Representatives and office locations

If you have any further questions relating to the products described in this manual, please contact your local representative at the Siemens branch nearest you.

Locate your contact person at "<http://www.automation.siemens.com/partner>".

Training center

Siemens AG offers a variety of training courses in order to familiarize you with automation systems. Contact your regional Training Center or the central Training Center in D-90327 Nuremberg, Germany.

Internet: "<http://www.sitrain.com>"

Technical support

Technical support for all industry sector products is available as follows:

Using the web form to request support

"<http://www.siemens.com/automation/support-request>"

Additional information about our technical support is available on the Internet under

"<http://support.automation.siemens.com>".

Service & Support on the Internet

Service & Support provides additional comprehensive information on SIMATIC products through online services at "<http://support.automation.siemens.com>":

- The newsletter offers you the latest information about your products
- A large document base is available using our Service & Support search engine
- A forum for global exchange of information by users and experts
- Current product information, FAQs and downloads
- You local representative
- Information about on-site services, repairs, spare parts, and more

Recycling and disposal

The HMI devices described in these operating instructions can be recycled due to the low levels of pollutants. Contact a certified disposal service company for environmentally sound recycling and disposal of your old devices.

Table of contents

	Preface	3
1	Overview	13
1.1	Product overview	13
1.2	MP 377 mounting devices.....	15
1.2.1	Design of the MP 377 12" Touch	15
1.2.2	Design of the MP 377 12" Key.....	17
1.2.3	Design of the MP 377 15" Touch	19
1.2.4	Design of the MP 377 19" Touch	21
1.3	MP 377 PRO	23
1.3.1	Design of the MP 377 PRO 15" Touch	23
1.3.2	Structure of the basic adapter.....	24
1.4	Accessory kit.....	25
1.5	Accessories.....	26
1.6	The HMI device in the operating process	28
1.7	Functional scope with WinCC flexible.....	29
1.8	Software options	32
1.9	Communication	33
2	Safety instructions and approvals	37
2.1	Safety instructions.....	37
2.2	Standards, certificates and approvals.....	39
2.3	Notes about usage.....	41
2.4	Electromagnetic compatibility	42
2.5	Transport and storage conditions	44
3	Planning application	45
3.1	Notes about usage.....	45
3.2	MP 377 mounting devices.....	47
3.2.1	Mounting positions and type of fixation.....	47
3.2.2	Preparing for installation	48
3.2.3	Information on insulation tests, protection class and degree of protection.....	50
3.2.4	Rated voltages	50
3.3	MP 377 PRO	51
3.3.1	Mounting positions	51
3.3.2	Preparing for installation	51
3.3.3	Information on insulation tests, protection class and degree of protection.....	52
3.3.4	Rated voltages	52

4	Mounting and connecting	53
4.1	Checking the package contents.....	53
4.2	Installing the HMI device.....	54
4.2.1	Installing the MP 377 mounting device.....	54
4.2.2	Installing MP 377 PRO.....	58
4.3	Connecting the HMI device.....	61
4.3.1	Overview.....	61
4.3.2	Ports.....	62
4.3.3	Connecting the equipotential bonding circuit.....	63
4.3.4	Connecting the power supply.....	65
4.3.5	Connecting an uninterruptible power supply.....	67
4.3.6	Connecting the PLC.....	68
4.3.7	Connecting the configuration PC.....	71
4.3.8	Connecting a USB device.....	74
4.3.9	Connecting a printer.....	75
4.3.10	Connecting an audio device.....	76
4.4	Switching on and testing the HMI device.....	77
4.5	Securing the cables.....	79
4.5.1	Securing cables on the MP 377 mounting device.....	79
4.5.2	Securing cables on the MP 377 PRO.....	79
4.6	Closing the housing rear wall of MP 377 PRO.....	80
5	Operator controls and displays	81
5.1	Front operator controls.....	81
5.2	Inserting a memory card.....	83
5.3	Securing memory card.....	84
5.4	Unplugging the memory card.....	85
5.5	Labeling the function keys on the MP 377 12" Key.....	86
6	Configuring the operating system	89
6.1	Loader.....	89
6.2	Setting up and disabling SecureMode.....	94
6.3	Viewer.....	95
6.4	Control Panel.....	96
6.4.1	Overview.....	96
6.4.2	Opening the Control Panel.....	97
6.4.3	Reference for functions.....	98
6.4.4	Operating the Control Panel.....	99
6.4.4.1	Overview.....	99
6.4.4.2	Operation using the touch screen.....	100
6.4.4.3	Operation with the keyboard.....	102
6.5	Changing settings for operation.....	106
6.5.1	Configuring the screen keyboard.....	106
6.5.2	Setting the character repeat.....	107
6.5.3	Setting the double-click.....	108
6.5.4	Calibrating the touch screen.....	110
6.6	Setting up password protection.....	112

6.7	Canceling password protection.....	113
6.8	Changing HMI device settings.....	114
6.8.1	Setting the date and time.....	114
6.8.2	Changing regional settings.....	115
6.8.3	Backup registry information.....	116
6.8.4	Changing monitor settings.....	118
6.8.5	Setting the screen saver.....	119
6.8.6	Changing the printer properties.....	120
6.8.7	Enabling sound and setting sound volume.....	122
6.8.8	Assigning sound to an event.....	124
6.8.9	Restarting the HMI device.....	125
6.8.10	Displaying information about the HMI device.....	127
6.8.11	Displaying system properties.....	128
6.8.12	Displaying memory distribution.....	129
6.9	Setting storage location.....	130
6.10	Setting the delay time.....	131
6.11	Setting the uninterruptible power supply.....	132
6.12	State of uninterruptible power supply.....	133
6.13	Enabling PROFINET IO.....	134
6.14	Changing transfer settings.....	136
6.14.1	Configuring the data channel.....	136
6.14.2	Changing MPI/PROFIBUS DP settings.....	139
6.15	Configuring network operation.....	142
6.15.1	Overview of network operation.....	142
6.15.2	Setting the device name of the HMI device.....	144
6.15.3	Changing the network configuration.....	145
6.15.4	Changing the logon data.....	147
6.15.5	Changing e-mail settings.....	148
6.15.6	Changing Internet settings.....	149
6.15.6.1	Changing general Internet settings.....	149
6.15.6.2	Setting the proxy server.....	150
6.15.6.3	Changing privacy settings.....	150
6.15.6.4	Importing and deleting certificates.....	152
6.16	Saving to external storage device (backup).....	153
6.17	Restoring from external storage device.....	155
6.18	Activate memory management.....	158
7	Commissioning a project.....	159
7.1	Overview.....	159
7.2	Operating modes.....	160
7.3	Using existing projects.....	161
7.4	Data transmission options.....	162
7.5	Transfer.....	163
7.5.1	Overview.....	163
7.5.2	Starting manual transfer.....	163
7.5.3	Starting automatic transfer.....	164
7.5.4	Starting backtransfer.....	166
7.5.5	Testing a project.....	167

7.6	Backup and restore	168
7.6.1	Overview	168
7.6.2	Backup and restore using WinCC flexible.....	169
7.6.3	Backup and restore using ProSave	171
7.7	Updating the operating system	173
7.7.1	Overview	173
7.7.2	Resetting factory settings.....	174
7.7.3	Updating the operating system using WinCC flexible.....	175
7.7.4	Updating the operating system using ProSave.....	176
7.7.5	Resetting to factory settings with WinCC flexible	177
7.7.6	Resetting to factory settings with ProSave	180
7.8	Installing and removing options	182
7.8.1	Overview	182
7.8.2	Installing and removing options using WinCC flexible	183
7.8.3	Installing and removing options using ProSave.....	185
7.9	Transferring and transferring back license keys	186
7.9.1	Overview	186
7.9.2	Transferring and transferring back license keys	187
8	Operating a project	189
8.1	Overview	189
8.2	Direct keys	192
8.3	Setting the project language	193
8.4	Entries using the touch screen.....	193
8.4.1	Overview	193
8.4.2	Entering and editing numerical values	195
8.4.3	Entering and editing alphanumerical values	197
8.4.4	Entering the date and time	199
8.4.5	Entering symbolic values	199
8.4.6	Displaying infotext	200
8.5	Entries using the keys	201
8.5.1	Control keys	201
8.5.2	Example: enter characters using the alphanumeric keyboard.....	204
8.5.3	Function keys	204
8.5.4	General procedures	205
8.5.5	Entering and editing numerical values	205
8.5.6	Entering and editing alphanumerical values	207
8.5.7	Entering the date and time	208
8.5.8	Entering symbolic values	208
8.5.9	Displaying infotext	209
8.6	Bar and gauge.....	210
8.7	Operating the switch	211
8.8	Operating the trend view.....	212
8.9	Operating the slider control	214
8.10	Operating the Status Force	216
8.10.1	Overview	216
8.10.2	Touch operation	217
8.10.3	Key control	218

8.11	Operating the Sm@rtClient view	220
8.11.1	Overview	220
8.11.2	Touch operation	221
8.11.3	Key control	223
8.12	Project security	224
8.12.1	Overview	224
8.12.2	User view	226
8.12.3	User logon.....	227
8.12.4	User logoff.....	228
8.12.5	Creating users.....	229
8.12.5.1	Creating users with touch operation	229
8.12.5.2	Creating users with key operation.....	230
8.12.6	Changing user data.....	233
8.12.6.1	Changing user data with touch operation	233
8.12.6.2	Changing user data with key operation	234
8.12.7	Deleting users	235
8.13	Closing the project	236
9	Operating alarms	237
9.1	Overview	237
9.2	Detecting queued alarms	239
9.3	Message display	240
9.4	Displaying infotexts	242
9.5	Acknowledge alarm.....	243
9.6	Editing alarms	244
10	Operating recipes	245
10.1	Overview	245
10.2	Structure of a recipe.....	246
10.3	Recipes in the project	248
10.4	Recipe displays	250
10.5	Recipe values in the HMI device and the PLC	253
10.6	Operating the recipe view	254
10.6.1	Overview	254
10.6.2	Creating a recipe data record	255
10.6.3	Editing a recipe data record	257
10.6.4	Deleting a recipe data record.....	258
10.6.5	Synchronizing tags.....	259
10.6.6	Reading a recipe data record from the PLC	260
10.6.7	Transferring a recipe data record to the PLC	261
10.7	Operating the simple recipe view.....	262
10.7.1	Overview	262
10.7.2	Creating a recipe data record	264
10.7.3	Editing a recipe data record	265
10.7.4	Deleting a recipe data record.....	266
10.7.5	Reading a recipe data record from the PLC	267
10.7.6	Transferring a recipe data record to the PLC	268
10.8	Importing a recipe data record.....	269

10.9	Exporting a recipe data record.....	270
10.10	Examples	271
10.10.1	Entering a recipe data record.....	271
10.10.2	Manual production sequence.....	272
11	Maintenance and care	273
11.1	Maintaining and caring for the touch screen and keyboard overlay	273
11.2	Clean screen on MP 377 Touch	274
11.3	Spare parts and repairs.....	274
12	Technical specifications	275
12.1	Dimension drawings.....	275
12.1.1	Dimension drawings of the MP 377 12" Touch.....	275
12.1.2	Dimension drawings of the MP 377 12" Key.....	276
12.1.3	Dimension drawings of the MP 377 15" Touch.....	277
12.1.4	Dimension drawings of the MP 377 19" Touch.....	278
12.1.5	Dimension drawings of the MP 377 PRO 15" Touch.....	279
12.2	Specifications	280
12.3	Bit assignment of the direct keys	282
12.4	Description of the ports	283
12.4.1	Power supply.....	283
12.4.2	X10/IF 1B (RS 422/RS 485).....	283
12.4.3	X1 (PROFINET)	284
12.4.4	X20, X21 (USB).....	284
12.4.5	X40 (line out).....	285
A	Appendix.....	287
A.1	ESD guideline	287
A.2	System alarms	289
B	Abbreviations	321
	Glossary	323
	Index.....	329

Overview

1.1 Product overview

The Multi Panel MP 377 HMI devices are an innovative advanced development of the 370 series.

In addition to the established display sizes of 12", 15", and 19", the product series was expanded to include the Multi Panel MP 377 PRO 15" Touch offering all around IP65 degree of protection. The distinguishing feature of the HMI devices is that they fulfill the increasing demands for technical innovation – especially in regard to display, performance and extended applications.

Hardware equipment

The Multi Panel MP 377 has a TFT display with 64 K colors and improved performance compared to predecessor devices. The Multi Panel MP 377 is based on Microsoft Windows CE 5.0. Compared with previous devices, its multimedia functionality has been greatly extended. Integration of the Microsoft Media Player allows the MP 377 to play videos. Internet Explorer 6.0 for pocket PCs is pre-installed on the HMI devices and extends the ways in which web pages can be displayed. Word documents, Excel spreadsheets and PDF documents can be displayed with Microsoft Viewer.

The user memory has been expanded, and a retentive maintenance-free alarm buffer integrated. A retentive memory for PLC data is provided to support WinAC MP.

Thanks to the wide range of devices, you can use the device best suited to your needs. The MP 377 can be used for a wide range of applications, and offers high performance and a favorable cost/performance ratio.

The HMI device has:

- 1 PROFIBUS interface
- 2 Ethernet ports for connection to PROFINET
- 2 USB 2.0 ports
- 1 slot for an SD memory card or multimedia card
- 1 CF card slot
- 1 TFT display with up to 64 K colors

The following extra software options have been added to the functions of the MP 377 as a "multifunctional platform":

- WinCC flexible /Sm@rtService
- WinCC flexible /Sm@rtAccess
- WinCC flexible /OPC Server
- WinCC flexible /ProAgent
- WinCC flexible /Audit
- WinAC MP 2007

IP65 all-round

The Multi Panel MP 377 PRO, which features a housing with IP65 degree of protection, all around protection against dust and water jets. The ready-to-use HMI device can be fixed either from the top or the bottom to a support arm system or to a stand.

A basic adapter and adapter sets that can be ordered separately support fixing systems from various manufacturers (including VESA standard for flat screens). The rear wall can be removed quite easily. The interfaces of the HMI device can therefore be reached without any problems. You do not require any special cables or connectors.

The Multi Panel MP 377 PRO is impressive not only due to ease of servicing but also because of its sophisticated design and slimline device depth.

1.2 MP 377 mounting devices

1.2.1 Design of the MP 377 12" Touch

Front view and side view

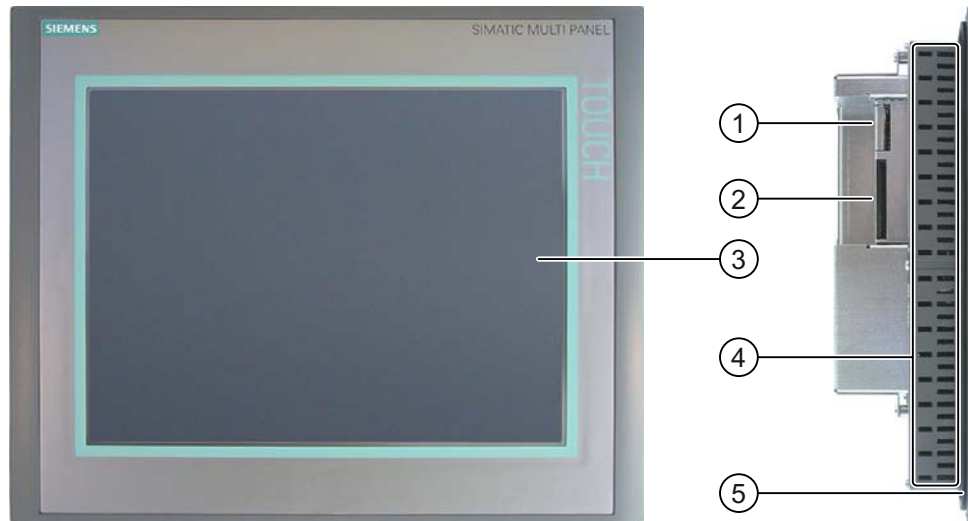

- ① Slot for an SD memory card or multimedia card
- ② Slot for a CF memory card
- ③ Display/touch screen
- ④ Oblong holes for mounting clamps
- ⑤ Mounting seal

Bottom view

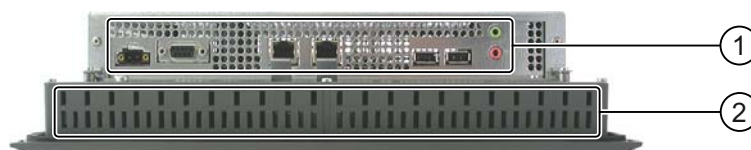

- ① Ports
- ② Oblong holes for mounting clamps

Rear view

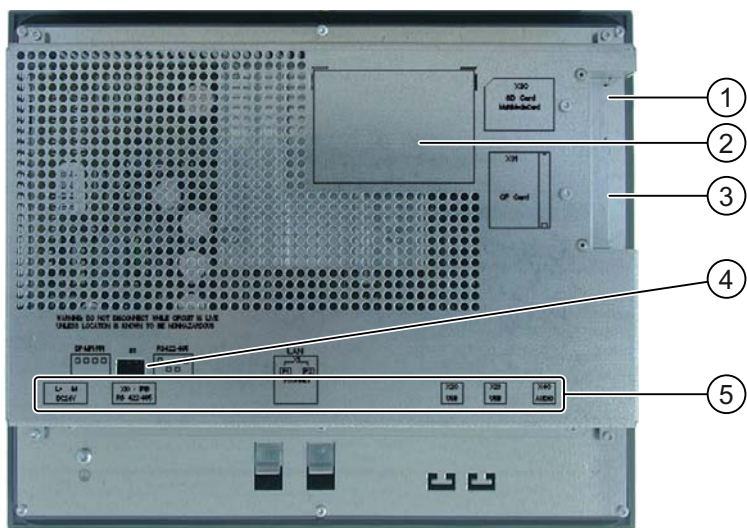

- ① Slot for an SD memory card or multimedia card
- ② Rating label
- ③ Slot for a CF memory card
- ④ DIP switch
- ⑤ Interface name

See also

Ports (Page 62)

1.2.2 Design of the MP 377 12" Key

Front view and side view



- ① Slot for an SD memory card or multimedia card
- ② Slot for a CF memory card
- ③ Display
- ④ Oblong holes for a mounting clamp
- ⑤ Mounting seal

Bottom view

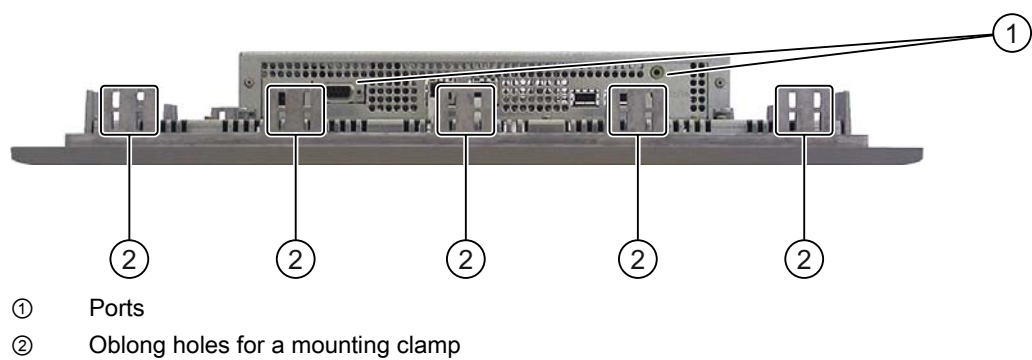

- ① Ports
- ② Oblong holes for a mounting clamp

Rear view

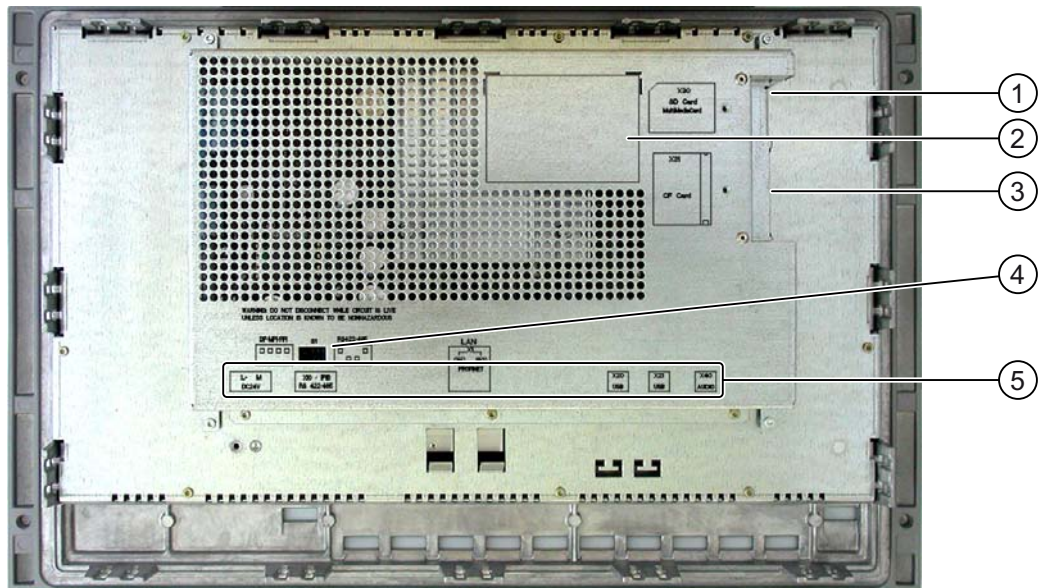

- ① Slot for an SD memory card or multimedia card
- ② Rating label
- ③ Slot for a CF memory card
- ④ DIP switch
- ⑤ Interface name

See also

Ports (Page 62)

1.2.3 Design of the MP 377 15" Touch

Front view and side view

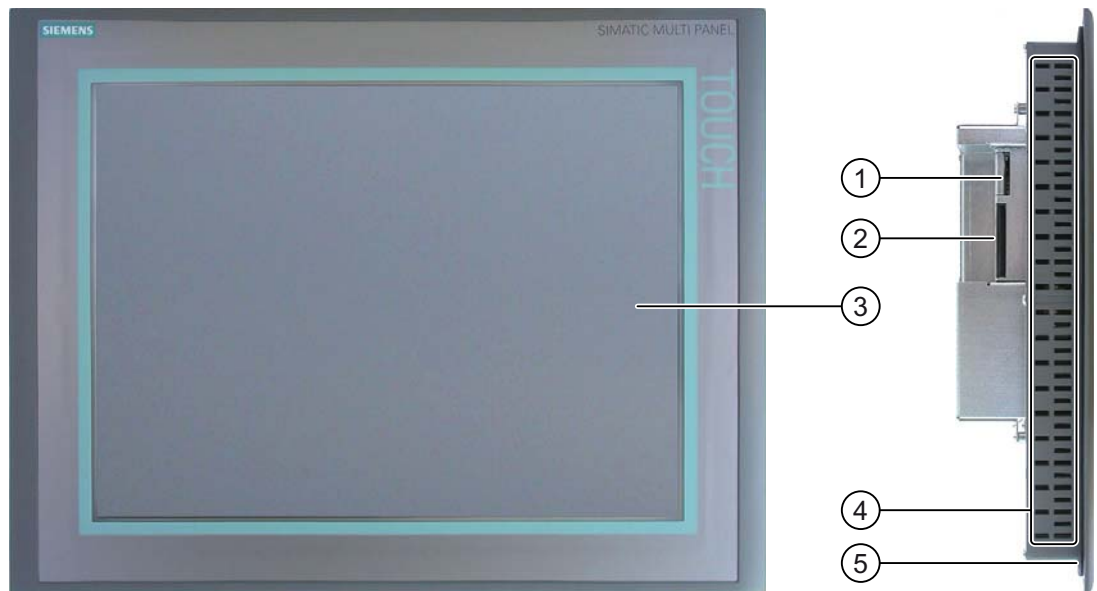

- ① Slot for an SD memory card or multimedia card
- ② Slot for a CF memory card
- ③ Display/touch screen
- ④ Oblong holes for mounting clamps
- ⑤ Mounting seal

Bottom view

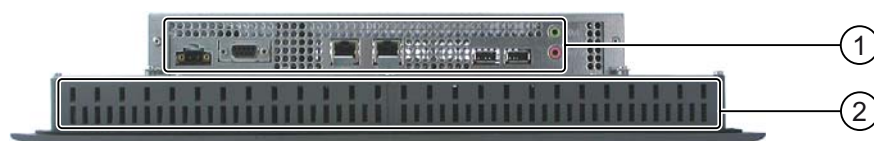

- ① Ports
- ② Oblong holes for mounting clamps

Rear view

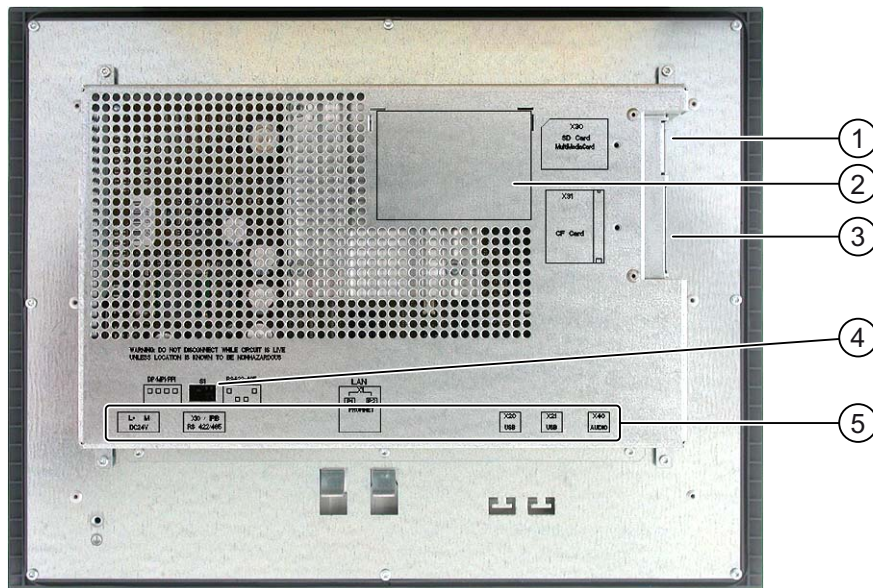

- ① Slot for an SD memory card or multimedia card
- ② Rating label
- ③ Slot for a CF memory card
- ④ DIP switch
- ⑤ Interface name

See also

Ports (Page 62)

1.2.4 Design of the MP 377 19" Touch

Front view and side view

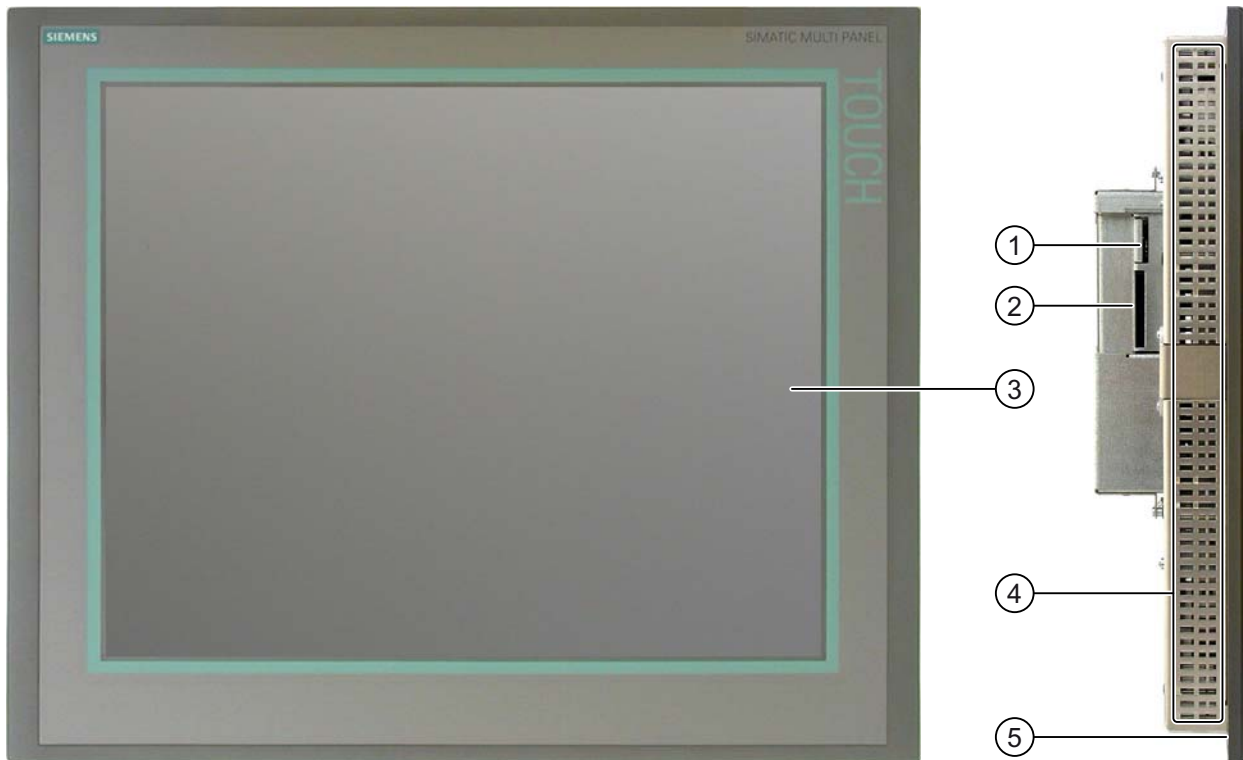

- ① Slot for an SD memory card or multimedia card
- ② Slot for a CF memory card
- ③ Display/touch screen
- ④ Oblong holes for mounting clamps
- ⑤ Mounting seal

Bottom view

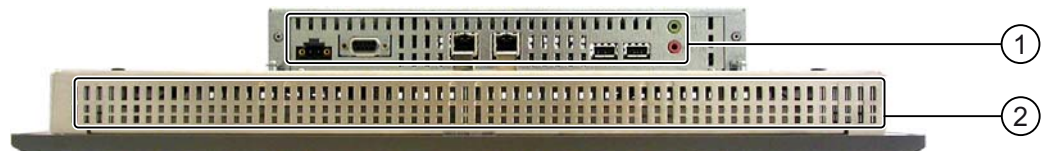

- ① Ports
- ② Oblong holes for mounting clamps

1.3 MP 377 PRO

1.3.1 Design of the MP 377 PRO 15" Touch

Front view and side view

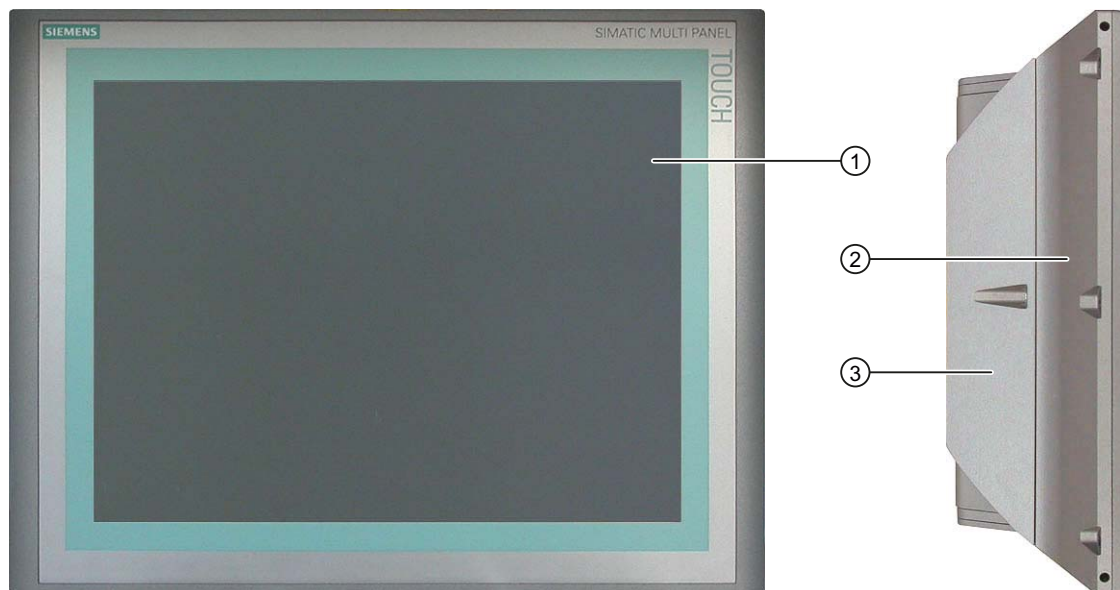

- ① Display with touch screen
- ② Housing
- ③ Housing rear panel

Bottom view

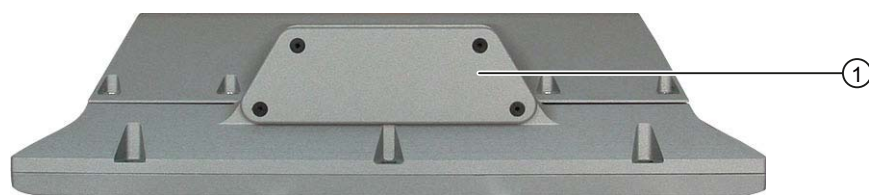

- ① Lower cover

Rear view



- ① Housing rear panel
- ② Lower cover

1.3.2 Structure of the basic adapter

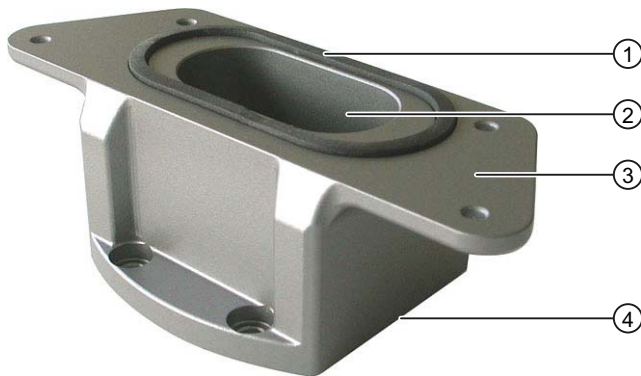

- ① Seal
- ② Cable channel
- ③ Mechanical interface to the MP 377 PRO
- ④ Mechanical interface to the adapter from the adapter set

The basic adapter is included in the product package of the MP 377 PRO. An adapter set forms part of the basic adapter and can be ordered as an accessory. The basic adapter and adapter set are required in order to fit the MP 377 PRO to a support arm or on a stand.

See also

Accessories (Page 26)

1.4 Accessory kit

Accessory kit for MP 377 mounting device

The accessory kit contains the following:

- Mains terminal for the power supply
- Mounting clamps for mounting the HMI device

Additional documents may be enclosed with the accessory kit.

Accessory kit for MP 377 PRO

The accessory kit contains the following:

- Mains terminal for the power supply
- Basic adapter as a basic element for fixing to a support arm
- Four screws for fixing the basic adapter to an adapter from an adapter set

Additional documents may be enclosed with the accessory kit.

1.5 Accessories

Accessories are not included in the product package of the HMI device, but can be ordered in the Internet at "<http://mall.automation.siemens.com>".

RS 422 to RS 232 converter

The converter is required for the connection of controllers of other manufacturers. Connect the RS 422 to RS 232 converter to the RS 422 / RS 485 interface. The converter converts the input signals to RS-232 signals.

Order number for RS 422 to RS 232 converter: 6AV6 671-8XE00-0AX0.

90° elbow adapter

If space is limited, you can use an elbow adapter at the RS 422/RS 485 interface.

Order number for 90° elbow adapter: 6AV6 671-8XD00-0AX0.

Protective foil for HMI devices with touch screen

The protective foil prevents the touch screen from being scratched.

The protective foil can be ordered using the following order numbers:

HMI device	Order no.
MP 377 12" Touch	6AV6 574-1AD00-4CX0
MP 377 15" Touch MP 377 PRO 15" Touch	6AV6 574-1AD00-4EX0
MP 377 19" Touch	6AV7 672-1CE00-0AA0

Clamping frame

A clamping frame is available for the MP 377 12" Touch. If the material thickness around the mounting cutout is < 2 mm, the clamping frame allows IP65 degree of protection or enclosure type 4X/Type 12 to be achieved.

Order number for clamping frame for MP 377 12" Touch: 6AV6 671-8XS00-0AX0.

Key labeling strips

For the MP 377 12" Key, a kit containing two sets of blank key labeling strips can be ordered.

Order number for key labeling strips: 6AV6 574-1AB00-2BA0.

Service packages

The service packages include:

- Mounting seals
- Mounting clamps
- Power supply terminal, 2-pin

Service packages can be ordered for the following HMI devices using the following order numbers:

HMI device	Order no.
MP 377 12" Key	6AV6 574-1AA00-2BX0
MP 377 12" Touch	6AV6 671-4XA00-0AX0
MP 377 15" Touch	
MP 377 19" Touch	

Basic adapter

One basic adapter is included in the delivery scope of the MP 377 PRO 15" Touch.

Order number for the basic adapter as accessory: 6AV7674-0KA00-0AA0.

Adapter sets for support arm systems

The following adapter sets can be ordered for the MP 377 PRO:

Adapter set	Suitable for support arm systems	Order no.
Adapter set VESA75/VESA100	VESA75 and VESA100 compatible systems, Rose GTN II support arm systems	6AV7674-0KF00-0AA0
Adapter set CP-L	Rittal CP-L support arm systems	6AV7674-0KC00-0AA0
Adapter set PLUS	Bernstein CS-3000 Coupler 48, Rolec tara Plus, Rolec Quadro, Rittal CP-S, Rose GT48/2, Rose GTK electronic	6AV7674-0KB00-0AA0

Memory card

Only use SD memory cards, CF memory cards or MultiMediaCards tested and approved by Siemens AG.

SIMATIC PC USB flash drive

The SIMATIC PC USB flash drive is a mobile form of data storage with a high data throughput, designed for industrial use.

1.6 The HMI device in the operating process

The HMI device is part of the operating process. The following two phases are key to the way the HMI device is integrated in the operating process:

- Project design
- Process management

Project design

Visualization of the operating process is known as project design. Project design comprises:

- writing project data
- saving project data
- testing project data
- simulating project data

Project design is undertaken independently of the HMI device and results in a project. Once this has been generated, the project can be transferred to the HMI device to control the operating process.

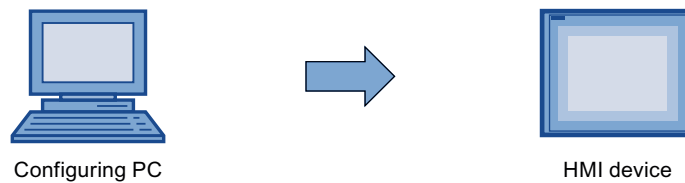

Process management

Process management is marked by two-way communication between HMI device and controller. This lays the foundations for operator control and monitoring.

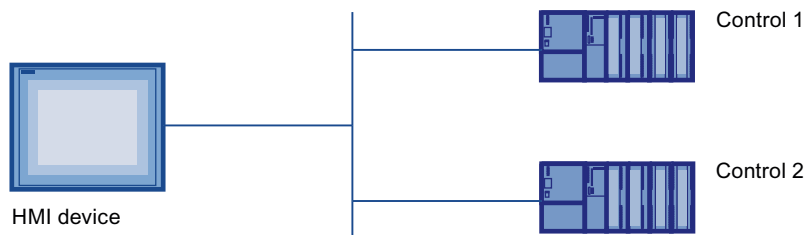

The operator can intervene in the operating process on the HMI device for control purposes. The controller in turn supplies the results of the operating process which are displayed on the HMI device.

1.7 Functional scope with WinCC flexible

The following tables show the objects that can be integrated in a project for an MP 377.

Note

The specified values are maximum values of the individual objects. Simultaneous use of multiple objects with their maximum value can lead to problems in the active project.

Alarms

Object	Specification	MP 377
Alarms	Number of discrete alarms	4 000
	Number of analog alarms	200
	Length of the alarm text	80 characters
	Number of tags in an alarm	Max. 8
	Display	Alarm line, Alarm window, Alarm view
	Acknowledge error alarm individually	Yes
	Acknowledge multiple error alarms simultaneously (group acknowledgement)	16 alarm groups
	Edit alarm	Yes
	Alarm indicator	Yes
ALARM_S	Display S7 alarms	Yes
Alarm buffer, retentive	Alarm buffer capacity	1024 alarms
	Simultaneously queued alarm events	Max. 500
	View alarm	Yes
	Delete alarm buffer	Yes
	Print alarms line by line	Yes

Tags, values and lists

Object	Specification	MP 377
Tags	Quantity	2 048
Limit value monitoring	Input/output	Yes
Linear scaling	Input/output	Yes
Text lists	Quantity	500 ¹⁾
Graphics lists	Quantity	500 ¹⁾

¹⁾ The maximum total of text and graphics lists is 500.

Screens

Object	Specification	MP 377
Screens	Quantity	500
	Fields per screen	200
	Tags per screen	400
	Complex objects per screen (for example, bars)	20
	Template	Yes

Recipes

Object	Specification	MP 377
Recipes	Quantity	500
	Data records per recipe	1000
	Entries per recipe	1000
	Recipe memory	128 Kb
	Location ¹⁾	<ul style="list-style-type: none"> • Memory card • USB memory stick • Network drive

1) The number of recipe data records might be restricted by the capacity of the storage medium.

Logs

Note

The HMI devices are suitable for the logging of relatively small volumes of data.

Manage the data in several adjacent archives in a segmented circular log. The use of a large circular log has a negative effect on performance.

Object	Specification	MP 377
Logs	Number of logs	50
	Number of partial logs in a segmented circular log	400
	Entries per log	10 000
	Filing format	CSV with ANSI character set
	Location ¹⁾	<ul style="list-style-type: none"> • Memory card • USB memory stick • Network drive

1) The number of entries in the log may be restricted by the capacity of the storage medium.

Safety

Object	Specification	MP 377
User view	Number of user groups	50
	Number of users	50
	Number of authorizations	32

Info texts

Object	Specification	MP 377
Info texts	Length (no. of characters)	320 (depending on font)
	For alarms	Yes
	For screens	Yes
	For screen objects (for example, for I/O field, switch, button, invisible button)	Yes

Additional functions

Object	Specification	MP 377
Screen settings	Calibrating the touch screen ¹⁾	Yes
	Brightness setting	Yes
Language change	Number of languages	16
VBScript	User-specific extension of the functionality	Yes
	Number of scripts	100
Graphic objects	Vector and pixel graphics	Yes
Trends	Quantity	400
Task planner	Number of tasks	48
Text objects	Quantity	30 000
Direct keys	PROFIBUS DP direct keys	Yes
	PROFINET IO direct keys	Yes

¹⁾ MP 377 with touch screen only

1.8 Software options

The following software options are available for the MP 377:

- WinCC flexible /Sm@rtService

The WinCC flexible /Sm@rtService option enables you to access a remote HMI device or PC via Ethernet.

- WinCC flexible /Sm@rtAccess

The WinCC flexible /Sm@rtAccess option enables you to set up communication between different HMI systems.

- WinCC flexible /Audit

The WinCC flexible /Audit option extends the HMI device to include functions for recording operations in an audit trail and electronic signature.

- WinCC flexible /OPC-Server (OPC XML)

The WinCC flexible /OPC-Server option enables you to create communications to OPC-capable applications from an HMI device or PC via Ethernet.

- WinAC MP 2007

WinAC MP 2007 is PLC software capable of running on the MP 377.

- WinCC flexible /ProAgent

The WinCC flexible /ProAgent option enables you to extend the HMI device to include specific and high-speed process fault diagnostics.

- Uninterruptible Power Supply (UPS) with USB support

When interfacing an uninterruptible power supply, the HMI device is shut down in a controlled manner after a buffer time in the event of a power failure. The MP 377 supports SITOP DC UPS modules connected via the USB port.

- Microsoft Excel Viewer

Microsoft Excel Viewer enables you to view Excel documents.

- Microsoft PDF Viewer

Microsoft PDF Viewer enables you to view PDF documents.

- Microsoft Word Viewer

Microsoft Word Viewer enables you to view Word documents.

1.9 Communication

Number of connections

Connection	MP 377
Number using a bus connection	6
Number of connections based on "SIMATIC HMI HTTP Protocol"	8

NOTICE

Communication faults with PROFINET IO

When you release PROFINET IO in the HMI device's control panel, communication faults may arise in the following cases:

- Use of PLCs from other manufacturers
- Use of SIMATIC 500/505 via NITP

Do not release PROFINET IO in the HMI device's control panel in the cases given.

PLCs

The following table shows the PLCs which can be used with the HMI devices and the protocols or profiles which can be used.

PLC	Protocol	MP 377
SIMATIC S7	<ul style="list-style-type: none"> • PPI • MPI ¹⁾ • PROFIBUS DP • PROFINET 	Yes
SIMATIC S5	<ul style="list-style-type: none"> • PROFIBUS DP 	Yes
SIMATIC 500/505	<ul style="list-style-type: none"> • NITP • PROFIBUS DP 	Yes
SIMATIC HMI HTTP Protocol	<ul style="list-style-type: none"> • HTTP/HTTPS (Ethernet) 	Yes
Allen-Bradley	PLC series SLC500, SLC501, SLC502, SLC503, SLC504, SLC505, MicroLogix and PLC5/11, PLC5/20, PLC5/30, PLC5/40, PLC5/60, PLC5/80 <ul style="list-style-type: none"> • DF1 ^{2) 5) 6)} • DH+ via KF2 module ^{3) 5) 6)} • DH485 via KF3 module ^{4) 5) 6)} • DH485 ^{4) 6)} 	Yes
	ControllLogix and CompactLogix PLC series <ul style="list-style-type: none"> • Ethernet/IP 	Yes
GE Fanuc Automation	PLC series 90-30, 90-70, VersaMax Micro <ul style="list-style-type: none"> • SNP⁶⁾ 	Yes
LG Industrial Systems (Lucky Goldstar)/IMO	PLC series GLOFA GM (GM4, GM6 and GM7), Series G4, G6 and G7 <ul style="list-style-type: none"> • Dedicated communication ⁶⁾ 	Yes
Mitsubishi Electric	PLC series MELSEC FX and MELSEC FX0 <ul style="list-style-type: none"> • FX⁶⁾ 	Yes
	PLC series MELSEC FX0, FX1n, FX2n, AnA, AnN, AnS, AnU, QnA and QnAS <ul style="list-style-type: none"> • Protocol ^{4) 6)} 	Yes
Modicon (Schneider Automation)	PLC series Modicon 984, TSX Quantum and TSX Compact <ul style="list-style-type: none"> • Modbus RTU ^{5) 6)} 	Yes
	PLC series Quantum, Momentum, Premium and Micro PLC series Compact and 984 via Ethernet bridge <ul style="list-style-type: none"> • Modbus TCP/IP (Ethernet) 	Yes

PLC	Protocol	MP 377
OMRON	PLC series SYSMAC C, SYSMAC CV, SYSMAC CS1, SYSMAC alpha and CP <ul style="list-style-type: none"> Hostlink/Multilink (SYSMAC Way)⁶⁾ 	Yes
Telemecanique	PLC series TSX 7 with P47 411, TSX 7 with P47/67/87/107 420, TSX 7 with P47/67/87/107 425, module TSX SCM 21.6 with the specified TSX 7 CPUs, TSX 17 with module SCG 1161, TSX 37 (Micro) and TSX 57 (Premium) <ul style="list-style-type: none"> Hostlink/Multilink (SYSMAC Way)⁶⁾ 	Yes

- 1) Not possible when connected to S7-212.
- 2) Applies to controllers SLC503, SLC504, SLC505, PLC5, MicroLogix.
- 3) Applies to controllers SLC504, PLC5 over DF1.
- 4) Applies to controllers SLC500 to SLC 505 and MicroLogix.
- 5) Only with converter RS 422-RS 232 6AV6 671-8XE00-0AX0 (option).
- 6) PROFINET IO must be locked.

Safety instructions and approvals

2.1 Safety instructions

High frequency radiation

NOTICE
Unwanted operating states High-frequency radiation, for example, from cellular phones, can trigger unwanted operating states.

Proper use

 WARNING
Commissioning the HMI device is prohibited until it has been absolutely ensured that the machine in which the HMI device is to be installed complies with Directive 98/37/EC or Directive 2006/42/EC as of December 29, 2009.

Hazardous areas

When operating the HMI device in hazardous areas the following warning applies.

 WARNING
Explosion Hazard Do not disconnect while circuit is live unless area is known to be non-hazardous. Substitution of components may impair suitability for Class I, Division 2 or Zone 2.

Working on the control cabinet

The following information applies to MP 377 mounting devices.

 WARNING
--

Open equipment

The HMI device is open equipment. This means that the HMI device may only be mounted in housings or cabinets, whereby the device can be operated from the front panel.
--

The cubicle or cabinet in which the HMI device is installed may only be accessed with a key or tool and only by trained, authorized personnel.
--

Dangerous voltage

Opening the cabinet will expose high voltage parts. Contact with these parts could be fatal.
--

Always disconnect the cabinet from the mains before opening it.

2.2 Standards, certificates and approvals

Approvals

 CAUTION
The following overview shows possible approvals. The HMI device itself is certified as shown on the rear panel labels.

CE approval



The HMI device meets the general and safety-related requirements of the following EC directives and conforms to the harmonized European standards (EN) for programmable logic controllers published in the official gazettes of the European Union:

- 2004/108/EC "Electromagnetic Compatibility" (EMC Directive)
- 2006/95/EC "Electrical equipment for use within specific voltage limits" (Low-Voltage Directive)

EC Declaration of Conformity

The EC Declarations of Conformity are available to the relevant authorities at the following address:

Siemens Aktiengesellschaft
Industry Sector
I IA AS RD ST PLC
P.O. Box 1963
D-92209 Amberg

UL approval



Underwriters Laboratories Inc., to

- UL 508 (Industrial Control Equipment)
- CSA C22.2 No. 142 (Process Control Equipment)

or



HAZ. LOC.

Underwriters Laboratories Inc., to

- UL 508 (Industrial Control Equipment)
- CSA C22.2 No. 142 (Process Control Equipment)
- UL 1604 (Hazardous Location)
- CSA-213 (Hazardous Location)

Approved for use in

- Class I, Division 2, Group A, B, C, D or
- Class I, Zone 2, Group IIC or
- non-hazardous locations

FM approval (MP 377 mounting device only)



Factory Mutual Research (FM) conforming to

- Approval Standard Class Number 3611, 3600, 3810

Approved for use in

- Class I, Division 2, Group A, B, C, D T4
- Class I, Zone 2, Group IIC T4

Marking for Australia



The HMI device fulfills the requirements of standard AS/NZS 2064 (Class A).

IEC 61131

The HMI device fulfills requirements and criteria to IEC 61131-2, Programmable Logic Controllers, Part 2: Operating resource requirements and tests.

2.3 Notes about usage

Industrial applications

The HMI device is designed for industrial applications. It conforms to the following standards:

- Requirements for emissions EN 61000-6-4: 2007
- Requirements for interference immunity EN 61000-6-2: 2005

Use in residential areas

Note

The HMI device is not intended for use in residential areas. Operation of an HMI device in residential areas can have a negative influence on radio/TV reception.

If the HMI device is used in a residential area, you must take measures to achieve Limit Class B conforming to EN 55011 for RF interference.

Suitable measures for achieving the degree of noise suppression for Limit Class B include, for example:

- Installation of the HMI device in grounded control cabinets
- Use of filters in electrical supply lines

Individual acceptance is required.

2.4 Electromagnetic compatibility

Introduction

The HMI device fulfills, among other things, the requirements of the EMC law pertaining to the domestic European market.

EMC-compatible installation of the HMI device

The EMC-compliant installation of the HMI device and the application of interference-proof cable is the basis for interference-free operation. The "Directives for interference-free installation of PLCs" and the "PROFIBUS Networks" manual also apply for the installation of the HMI device.

Pulse-shaped disturbance

The following table shows the electromagnetic compatibility of modules with regard to pulse-shaped interference. The precondition for electromagnetic compatibility is that the HMI device meets the specifications and guidelines for electrical installation.

Pulse-shaped disturbance	Tested with	Degree of severity
Electrostatic discharge in accordance with IEC 61000-4-2	Air discharge: 8 kV Contact discharge: 6 kV	3
Burst pulses (high-speed transient interference) in accordance with IEC 61000-4-4	2 kV power supply cable 2 kV signal cable, > 30 m 1 kV signal cable, < 30 m	3
High-power surge pulses in accordance with IEC 61000-4-5, external protective circuit required (refer to the manual Automation System S7-300, Installation, "Lightning and overvoltage protection" section)		
Asymmetrical coupling	2 kV power cable DC voltage with protective elements 2 kV signal/data cable, > 30 m, with protective elements as required	3
Symmetrical coupling	1 kV power cable DC voltage with protective elements 1 kV signal cable, > 30 m, with protective elements as required	3

Sinusoidal interference

The following table shows the EMC behavior of the modules with respect to sinusoidal interference. This requires the HMI device to meet the specifications and directives for electrical installation.

Sinusoidal interference	Test values	Degree of severity
HF radiation (in electromagnetic fields) in accordance with IEC 61000-4-3	<ul style="list-style-type: none"> 80% amplitude modulation at 1 kHz with 10 V/m in the range of 80 MHz to 1 GHz with 3 V/m in the range 1.4 GHz to 2 GHz with 1 V/m the range 2 GHz to 2.7 GHz 10 V/m with 50% pulse modulation at 900 MHz 10 V/m with 50% pulse modulation at 1.89 GHz 	3
RF interference current on cables and cable shielding conforming to IEC 61000-4-6	Test voltage 10 V, with 80% amplitude modulation of 1 kHz in the 9 MHz to 80 MHz range	3

Emission of radio interference

The following table shows the unwanted emissions from electromagnetic fields in accordance with EN 55011, Limit Value Class A, Group 1, measured at a distance of 10 m.

From 30 to 230 MHz	< 40 dB ($\mu\text{V/m}$) quasi-peak
From 230 to 1000 MHz	< 47 dB ($\mu\text{V/m}$) quasi-peak

Additional measures

If you want to connect an HMI device to the public power supply system, you must ensure Limit Value Class B in accordance with EN 55022.

2.5 Transport and storage conditions

Mechanical and climatic conditions for transportation and storage

This HMI device meets the requirements for IEC 61131-2 relating to transport and storage conditions. The following specifications apply to the transport and storage of an HMI device in its original packaging.

The climatic conditions conform to the following standards:

- IEC 60721-3-3, Class 3K7 for storage
- IEC 60721-3-2, Class 2K4 for transport

Mechanical requirements conform to EC 60721-3-2, Class 2M2.

Type of condition	Permitted range
Drop test (in transport package)	≤ 1 m
Temperature	From -20 to +60 °C
Atmospheric pressure	From 1 080 hPa to 660 hPa, corresponds to an elevation of -1000 to 3500 m
Relative humidity	From 10 to 90%, without condensation
Sinusoidal vibration in accordance with IEC 60068-2-6	5 to 9 Hz: 3.5 mm 9 Hz to 500 Hz: 9.8 m/s ²
Shock in accordance with IEC 60068-2-29	250 m/s ² , 6 ms, 1000 shocks

NOTICE

Avoid dewing

If the HMI device is subjected to low temperatures or extreme fluctuations in temperature during transportation, moisture could occur on or inside the HMI device. Dewing can occur. This can cause malfunctions.

The HMI device must have acquired room temperature before it is put into operation. Do not expose the HMI device to direct radiation from a heater in order to warm it up. If there is condensation, wait approximately 4 hours until the HMI device has dried completely before switching it on.

Proper transport and storage, installation and assembly as well as careful operation and maintenance are required to ensure trouble-free and safe operation of the HMI device.

The warranty for the HMI device will be deemed void if these stipulations are not heeded.

Planning application

3.1 Notes about usage

Mechanical and climatic conditions of use

The HMI device is designed for use in a location protected from the effects of the weather. The conditions of use meet the requirements for DIN IEC 60721-3-3:

- Class 3M3 (mechanical requirements)
- Class 3K3 (climatic requirements)

Use with additional measures

The HMI device should not be used at the following locations unless additional measures are taken:

- In locations with a high degree of ionizing radiation
- In locations with severe operating conditions, for example, due to:
 - Corrosive vapors, gases, oils or chemicals
 - Electrical or magnetic fields of high intensity
- In plants that require special monitoring - for example:
 - Elevators
 - Systems in especially hazardous rooms

Mechanical ambient conditions

The mechanical ambient conditions for the HMI device are specified in the following table in terms of sinusoidal vibration.

Frequency range in Hz	Constant	Occasional
$10 \leq f \leq 58$	Amplitude 0,0375 mm	Amplitude 0.075 mm
$58 \leq f \leq 150$	Constant acceleration 0,5 g	Constant acceleration 1 g

Reducing vibrations

If the HMI device is subjected to greater shocks or vibrations, you must take appropriate measures to reduce acceleration or amplitudes.

We recommend mounting the HMI device on damping materials (on rubber-metal vibration dampers, for example).

Testing mechanical ambient conditions

The following table provides information on the type and scope of tests for mechanical ambient conditions.

Tested for	Test standard	Comments
Vibrations	Vibration test in accordance with IEC 60068, part 2–6 (sinusoidal)	Type of vibration: Transitional rate of the frequency: 1 octave/minute. $10 \leq f \leq 58$, Constant amplitude 0.075 mm $58 \leq f \leq 150$, constant acceleration 1 g, with support arm 0.5 g on the basic adapter Vibration duration: 10 frequency cycles per axis at each of the three associated vertical axes
Shock	Shock test in accordance with IEC 60068, Part 2 –27	Type of shock: Half-sine Shock intensity: Peak value 15 g, duration 11 ms Direction of impact: 3 shocks in \pm direction at each one of the three associated vertical axes

Climatic ambient conditions

The following table shows the climatic ambient conditions for operation of the HMI device.

Ambient conditions	Permitted range	Comments
Temperature <ul style="list-style-type: none"> • Vertical installation MP 377 12" Touch MP 377 12" Key MP 377 15" Touch MP 377 19" Touch MP 377 PRO 15" Touch • Inclined installation MP 377 12" Touch MP 377 12" Key MP 377 15" Touch MP 377 19" Touch MP 377 PRO 15" Touch 	From 0 to 50° C From 0 to 50° C From 0 to 50° C From 0 to 50° C From 0 to 45° C From 0 to 40° C From 0 to 40° C From 0 to 35° C From 0 to 35° C From 0 to 45° C	MP 377 12" Touch, MP 377 12" Key, MP 377 15" Touch, MP 377 19" Touch: See section Mounting positions and type of fixation (Page 47) MP 377 PRO 15" Touch: See section Mounting positions (Page 51)
Relative humidity	10 to 90%, without condensation	
Atmospheric pressure	1 080 to 795 hPa	Corresponds to an elevation of –1 000 m to 2 000 m
Pollutant concentration	SO ₂ : < 0.5 vpm; Relative humidity < 60%, no condensation	Test: 10 cm ³ /m ³ ; 10 days
	H ₂ S: < 0.1 vpm; Relative humidity < 60%, no condensation	Test: 1 cm ³ /m ³ ; 10 days

3.2 MP 377 mounting devices

3.2.1 Mounting positions and type of fixation

Mounting position

The HMI device is suitable for installation in:

- Mounting cabinets
- Control cabinets
- Switchboards
- Consoles

In the following, all of these mounting options are referred to by the general term "cabinet".

The HMI device is self-ventilated and approved for vertical and inclined mounting in stationary cabinets.

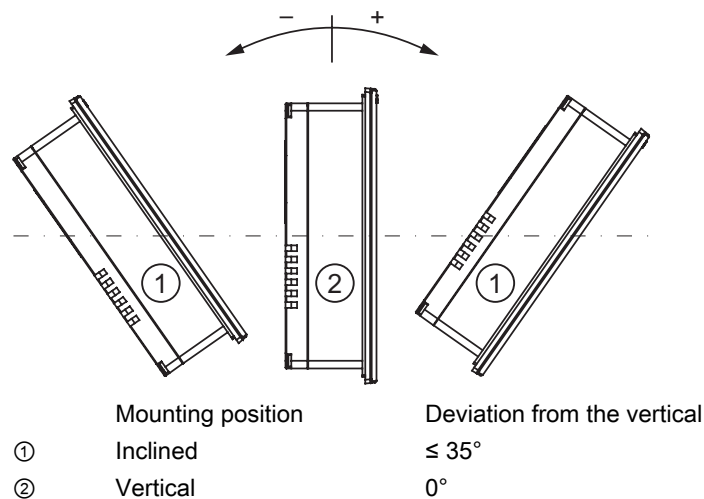

CAUTION

Damage due to overheating

An inclined installation reduces the convection by the HMI device and therefore the maximum permissible ambient temperature for operation.

If there is sufficient forced ventilation, the HMI device can also be operating in the inclined mounting position up to the maximum permissible ambient temperature for vertical installation.

Otherwise, the HMI device may be damaged and the approvals and warranty for the HMI device may become void.

For information regarding the permissible ambient temperatures, refer to Notes about usage (Page 45).

Mounting

Metal mounting clamps are provided for mounting. The mounting clamps hook into the oblong holes on the HMI device.

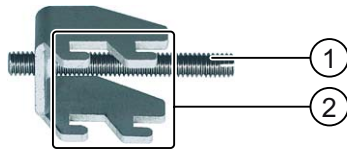

- ① Threaded pin
- ② Hook

3.2.2 Preparing for installation

Select the mounting location of the HMI device

Points to observe when selecting the mounting location:

- Position the HMI device so that it is not subjected to direct sunlight.
- Position the HMI device such that it is ergonomically accessible for the user.

Choose a suitable mounting height.

- Ensure that the air vents of the HMI device are not covered as a result of the mounting.
- Note the permissible mounting positions.

NOTICE
Stability of the mounting cutout
The material in the area of the mounting cutout must provide sufficient strength to guarantee the enduring and safe mounting of the HMI device.
The force of the clamps or operation of the device may not lead to deformation of the material in order to achieve the degrees of protection described below.

Degrees of protection

The protection ratings are only ensured if the mounting cutout conforms to the following:

- Material thickness at the mounting cutout for IP65 degree of protection or for enclosure type 4X/type 12 (indoor use only): 2 mm to 6 mm
- Permitted deviation from plane at the mounting cutout: ≤ 0.5 mm

This condition must be fulfilled for the mounted HMI device.

- Permissible surface roughness in the area of the seal: ≤ 120 μm (R_z 120)

A clamping frame is additionally available for mounting the MP 377 12" Touch to panels with a material thickness < 2 mm at the mounting cutout. The frame enables IP65 degree of protection or enclosure type 4X/type 12 to be achieved.

Dimensions of the mounting cutout

The following table shows the dimensions of the required mounting cutout:

Mounting cutout	MP 377 12" Touch	MP 377 12" Key	MP 377 15" Touch	MP 377 19" Touch
Width	310 ⁺¹ mm	450 ⁺¹ mm	367 ⁺¹ mm	449 ⁺¹ mm
Height	248 ⁺¹ mm	290 ⁺¹ mm	289 ⁺¹ mm	379 ⁺¹ mm
HMI device depth, not including front panel	72 mm	59 mm	72 mm	75 mm

Note

You can insert an MP 377 12" Key into the mounting cutout of the following HMI devices:

- MP 370 12" Key
- MP 277 10" Key
- MP 270 10" Key
- OP 270 10"

You can insert an MP 377 12" Touch into the mounting cutout of the following HMI devices:

- MP 370 12" Touch
- MP 277 10" Touch
- MP 270 10" Touch
- OP 270 10"

You can insert an MP 377 15" Touch into the mounting cutout of the following HMI device:

- MP 370 15" Touch

Maintaining clearances

The HMI device must be installed with the following clearances:

- 50 mm above and below the mounting cutout respectively for ventilation
- 15 mm to the right and left of the mounting cutout respectively for suspending the mounting clamps for mounting
- At least 10 mm behind the rear panel of the HMI device

NOTICE

Ensure that the maximum ambient temperature is not exceeded when mounting the device in a cabinet and especially in a closed enclosure.

3.2.3 Information on insulation tests, protection class and degree of protection

Test voltages

Insulation strength is demonstrated in the type test with the following test voltages in accordance with IEC 61131-2:

Circuits with a nominal voltage of U_n to other circuits or ground	Test voltage
< 50 V	500 V DC

Protection class

Protection Class I in accordance with IEC 60536, i.e. PE/ground terminal to profile rail required!

Protection against foreign objects and water

Degree of protection in accordance with IEC 60529	Explanation
Front	When mounted: <ul style="list-style-type: none">• IP65• Enclosure Type 4X/Type 12 (indoor use only)
Rear panel	IP20 Touch protection test with standard test probes. There is no protection against ingress by water.

The degree of protection at the front can only be guaranteed if the mounting seal is installed flush to the mounting cutout.

3.2.4 Rated voltages

The table below shows the rated voltage and the corresponding tolerance range.

Rated voltage	Tolerance range
+24 VDC	19.2 to 28.8 V (+/-20%)

3.3 MP 377 PRO

3.3.1 Mounting positions

Mounting position

The HMI device is self-ventilated and approved for vertical and inclined mounting.

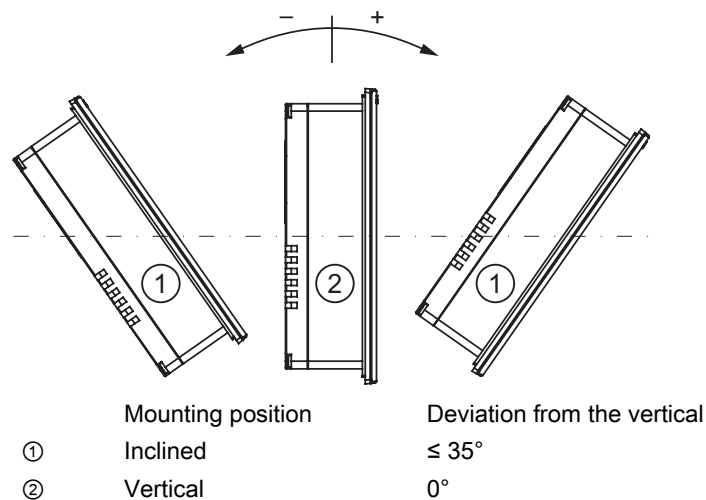

3.3.2 Preparing for installation

Select the mounting location of the HMI device

Points to observe when selecting the mounting location:

- Position the HMI device so that it is not subjected to direct sunlight.
- Position the HMI device such that it is ergonomically accessible for the user. Choose a suitable mounting height.
- Observe the permissible mounting positions for the HMI device.

3.3.3 Information on insulation tests, protection class and degree of protection

Test voltages

Insulation strength is demonstrated in the type test with the following test voltages in accordance with IEC 61131-2:

Circuits with a nominal voltage of U_n to other circuits or ground	Test voltage
< 50 V	500 VDC

Protection class

Protection Class I in accordance with IEC 60536, i.e. PE/ground terminal to profile rail required!

Protection against foreign objects and water

The following degree of protection applies to the HMI device:

Device side	Degree of protection in accordance with IEC 60529
all sides	<ul style="list-style-type: none"> • IP65 • Enclosure Type 12 (indoor use only) • Enclosure Type 4X/Type 12 (indoor use only)

3.3.4 Rated voltages

The table below shows the rated voltage and the corresponding tolerance range.

Rated voltage	Tolerance range
+24 VDC	19.2 to 28.8 V (+/-20%)

Mounting and connecting

4.1 Checking the package contents

Check the package content for visible signs of transport damage and for completeness.

NOTICE
Damaged parts A damaged part will cause the HMI device to malfunction. Do not install parts damaged during shipment. In the case of damaged parts, contact your Siemens representative.

The following is included in the product package of the MP 377 mounting device:

- HMI device
- Accessory kit with mounting clamps and mains terminal

The following is included in the product package of the MP 377 PRO:

- HMI device
- Basic adapter for fixing to a support arm
- Four screws for fitting the basic adapter
- Mains terminal

Additional documents may be included in the product package of all HMI devices.

The documentation belongs to the HMI device and is required for subsequent commissioning. Retain all enclosed documentation for the entire service life of the HMI device. You must pass on the enclosed documentation to any subsequent owner or user of the HMI device. Make sure that every supplement to the documentation that you receive is stored together with the operating instructions.

4.2 Installing the HMI device

4.2.1 Installing the MP 377 mounting device

Requirement

All packaging components and protective foils should be removed from the HMI device.

To install the HMI device, you need the mounting clamps from the accessory kit. The mounting seal must be fitted on the HMI device. If the mounting seal is damaged, order a replacement seal. The mounting seal is part of the associated service pack.

To ensure the necessary degree of protection on the HMI device, the mounting clamps must observe the positions listed below.

The following photo shows how positions 1 to 10 are counted.

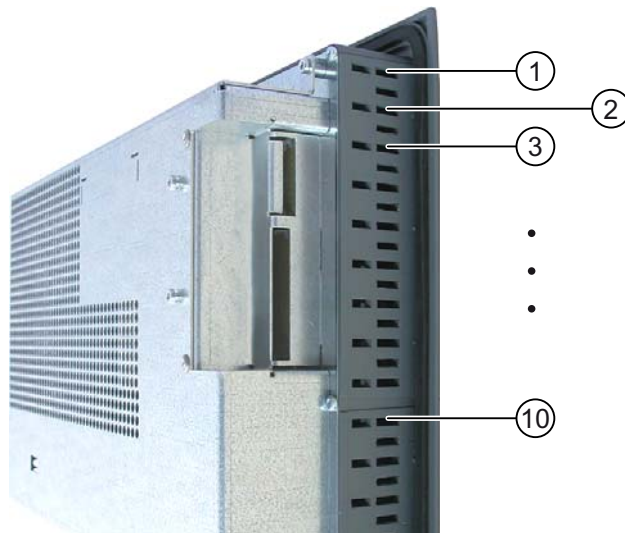

Positions of mounting clamps on the MP 377 12" Touch

The following figure shows the counting direction for the insertion of the mounting clamps.

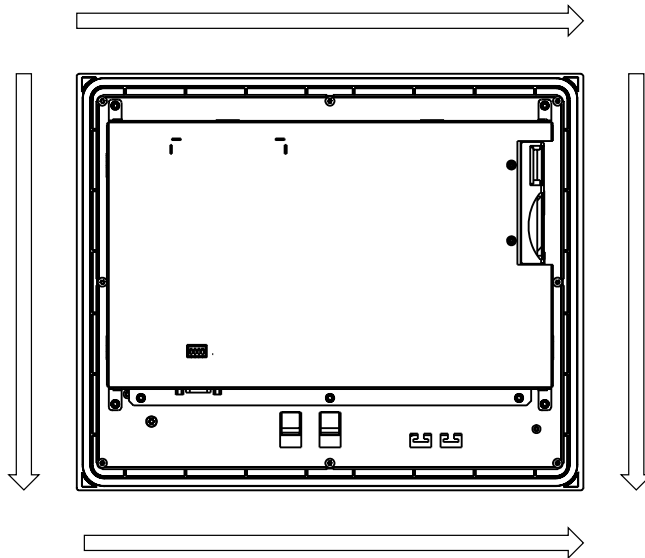

The following table shows the positions of the mounting clamps on the MP 377 12" Touch. Observe the counting direction.

Page	Number of mounting clamps	Position 1	Position 2	Position 3
Top	3	2	11	20
Right	3	2	9	16
Bottom	3	2	11	20
Left	3	2	9	16

Positioning the mounting clamps on the MP 377 12" Key

A total of 10 mounting clamps are needed for mounting. Fit mounting clamps in all the cutouts.

Positioning the mounting clamps on the MP 377 15" Touch

The following figure shows the counting direction for the insertion of the mounting clamps.

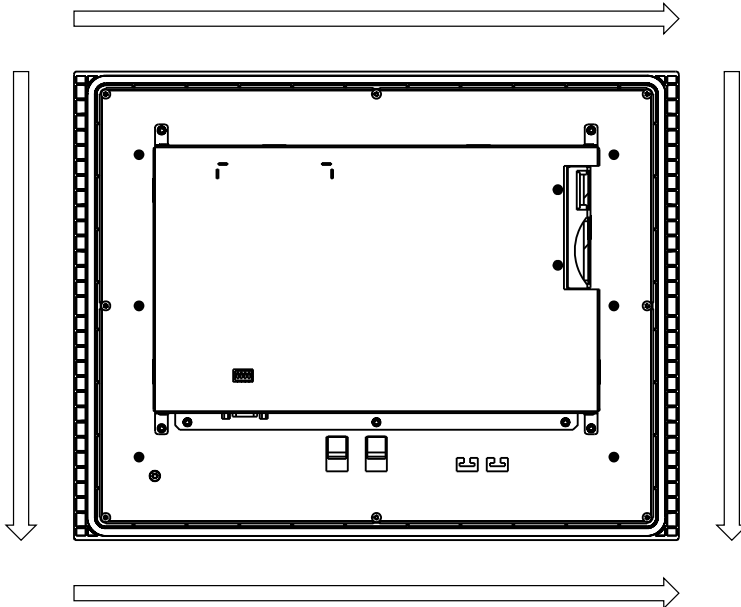

The following table shows the positioning of the mounting clamps on the MP 377 15" Touch. Observe the counting direction.

Page	Number of mounting clamps	Position 1	Position 2	Position 3	Position 4
Top	4	2	9	17	24
Right	3	3	10	17	–
Bottom	4	2	9	17	24
Left	3	3	10	17	–

Positions of the mounting clamps on the MP 377 19" Touch

The positions of the mounting clamps are marked by stamps on the cutouts.

The following diagram shows examples of these stamps.

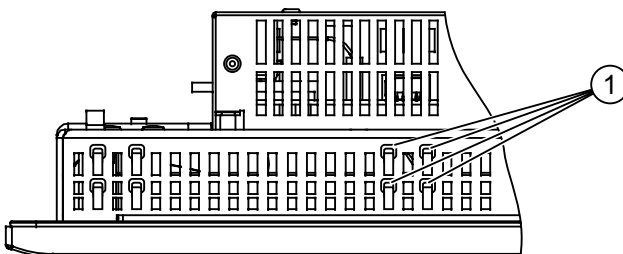

① Stamps identifying the position of a mounting clamp

A total of 18 mounting clamps are needed for mounting. Fit mounting clamps in all the stamped cutouts.

Procedure

NOTICE

Installation of the HMI device

Always mount the HMI device according to the instructions in this manual.

Risk of guaranteed level of protection not being met

If the mounting seal is damaged or protrudes beyond the HMI device, the level of protection is not ensured.

Check the fit of the mounting seal.

Note

Tighten the threaded pins of the mounting clamps until the HMI device is flush with the surface of the control cabinet. Alternatively, tighten the mounting clamps using a maximum torque of 0.2 Nm.

Proceed as follows:

1. Check that the mounting seal is fitted on the HMI device.
Do not install the mounting seal turned inside out. This may cause leaks in the mounting cutout.
2. Insert the HMI device into the mounting cutout from the front.
3. Insert a mounting clamp into the cutout provided on the HMI device.

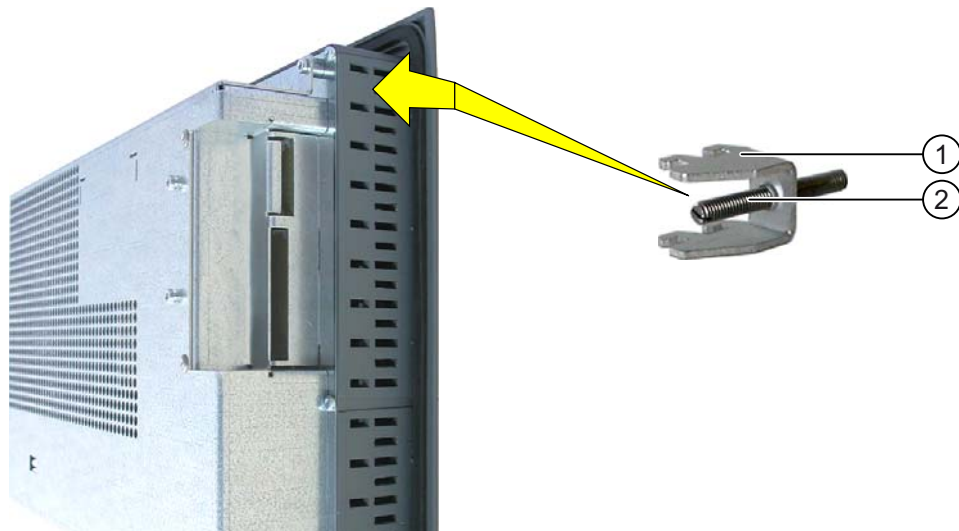

4. Fasten the mounting clamp ① by tightening the threaded pin ②.
5. Repeat steps 3 and 4 for all mounting clamps.
6. Check the fit of the mounting seal.
If necessary, repeat steps 1 to 6.

Result

The HMI device is mounted and the relevant level of protection is ensured at the front.

See also

- Accessory kit (Page 25)
- Accessories (Page 26)
- Information on insulation tests, protection class and degree of protection (Page 50)

4.2.2 Installing MP 377 PRO

Requirement

All packaging components and protective foils should be removed from the HMI device.

To install the HMI device, you need the basic adapter and an adapter set from the accessories.

The following cables are fed through the stand or the support arm to which the HMI device will be fixed:

- Equipotential bonding cable
- Power supply cable
- Data cables, such as PROFINET, USB

NOTICE
Warranty endangered If you install the HMI device not in accordance with the specifications given in these operating instructions, the warranty for the HMI device will become void. Always install the HMI device according to these operating instructions. IP65 degree of protection at risk If there are no seals on the adapters or these are damaged, then IP65 degree of protection is at risk. Check the condition and seating of the seals. If the seal on the rear panel of the housing is damaged, it can be repaired. For a repair scenario, follow the procedure described in the section "Spare parts and repairs (Page 274).

Note

The warranty for the IP65 degree of protection assumes that the support arm or the stand also complies with IP65.

Procedure

This section describes how to install the device on a support arm system. Installation on a stand is carried out analogously.

Proceed as follows:

1. Remove the 10 screws ⑥ of the housings rear panel using a size 2 Allen wrench.

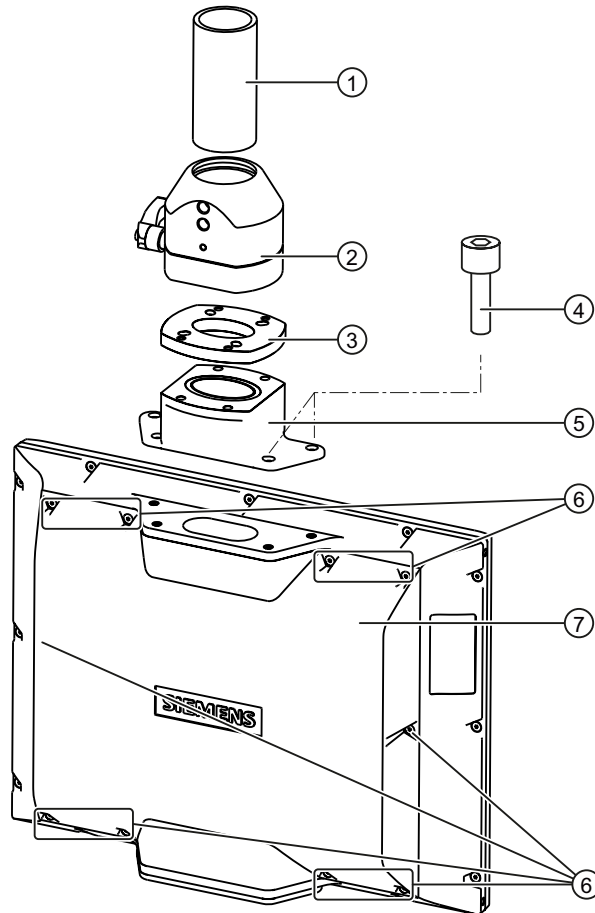

2. Remove the rear panel of the housing ⑦ and store it in a secure location.
3. Fasten the support arm head ② to the adaptor plate ③ using the four M6 x 12 screws from the accessory kit of the adapter set. Ensure that the seal is properly seated.
4. Fasten the base adapter ⑤ to the adaptor plate ③ using the four M6 x 12 screws from the accessory kit of the adapter set. Ensure that the seal is properly seated.

NOTICE

Do not exceed the permissible torque

If you fasten the screw ④ with a torque $> 1.2 \text{ Nm}$, the threads in the housing may be damaged.

Alternatively, tighten the screws using a maximum torque of 1.2 Nm.

5. Fasten the base adapter ⑤ to the mechanical interface using the four screws ④ of the cover. Ensure that the seal is properly seated.

6. Fasten the HMI device to the support arm ①.

In doing so, ensure that all connections are fed (without damage) through the adapter into the inside of the HMI device.

7. If you want to connect the cables at a later point in time, fasten the housing rear panel ⑦ to the HMI device.

Result

The HMI device is fitted and can be connected electrically.

See also

Accessory kit (Page 25)

4.3 Connecting the HMI device

4.3.1 Overview

Requirement

- The HMI device must be mounted according to the specifications of these operating instructions.
- Always use shielded standard cables for the data cable.

Additional information is available in the catalog and online order system at "<http://mall.automation.siemens.com>".

Connection sequence

Connect the HMI device in the following sequence:

1. Equipotential bonding
2. Power supply
Perform a power-up test to ensure the power supply is connected with the correct polarity.
3. PLC
4. Configuring PC as necessary
5. I/Os as necessary

NOTICE
Damage to the HMI device
If you do not keep to the connection sequence you could damage the HMI device.
Ensure you connect the HMI device in the sequence stipulated above.

Disconnect the HMI device by completing the above steps in reverse order.

Connecting the cables

When connecting the cables, ensure that the contact pins are not bent. Secure the cable connectors by screwing the connector onto the socket.

Provide adequate strain relief for the cables. For this purpose, the MP 377 PRO contains a strain relief bar below the ports on the rear of the HMI device.

4.3.2 Ports

The following figure shows the ports of the HMI device MP 377.

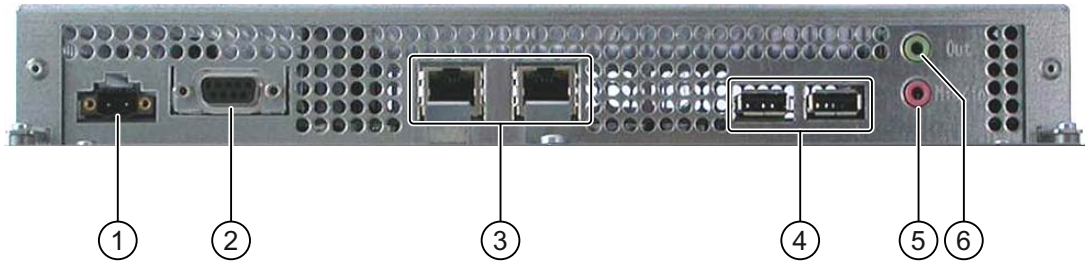

- ① Power supply connector
- ② RS-422/RS-485 port X10 / IF1b
- ③ PROFINET, 2 ports X1 P1 and X1 P2
- ④ USB, ports X20 and X21
- ⑤ Line in and micro
- ⑥ Line out

Connect PROFIBUS DP or MPI to the X10 / IF1b port.

You can affix the USB and PROFINET connecting cables to the rear panel of the HMI device with cable ties.

See also

Design of the MP 377 12" Touch (Page 15)

Design of the MP 377 12" Key (Page 17)

Design of the MP 377 15" Touch (Page 19)

Design of the MP 377 19" Touch (Page 21)

Design of the MP 377 PRO 15" Touch (Page 23)

4.3.3 Connecting the equipotential bonding circuit

Differences in electrical potential

Differences in electrical potential can develop between spatially separated plant components. Such electrical potential differences can lead to high equalizing currents over the data cables and therefore to the destruction of their interfaces. Equalizing currents can develop if the cable shielding is terminated at both ends and grounded to different plant parts.

Differences in potential may develop when a system is connected to different mains supplies.

General requirements for equipotential bonding

Differences in potential must be reduced by means of equipotential bonding in order to ensure trouble-free operation of the relevant components of the electronic system. The following must therefore be observed when installing the equipotential bonding circuit:

- The effectiveness of equipotential bonding increases as the impedance of the equipotential bonding conductor decreases or as its cross-section increases.
- If two plant parts are interconnected by means of shielded data cables and their shielding is bonded at both ends to the grounding/protective conductor, the impedance of the additionally installed equipotential bonding cable must not exceed 10% of the shielding impedance.
- The cross-section of an equipotential bonding conductor must be capable of handling the maximum equalizing current. Experience has shown that equipotential bonding conductors with a minimum cross-section of 16 mm² should be fitted between the control cabinets or the ground point of the supporting arm or the stand for PRO HMI devices.
- Use equipotential bonding conductors made of copper or galvanized steel. Establish a large surface contact between the equipotential bonding conductors and the grounding/protective conductor and protect these from corrosion.
- Use a suitable cable clip to clamp the shield of the data cable flush to the equipotential bonding rail. Keep the length of cable between the HMI device and the equipotential bonding rail as short as possible.
- Route the equipotential bonding conductor and data cables in parallel and with minimum clearance between these.

Wiring diagram

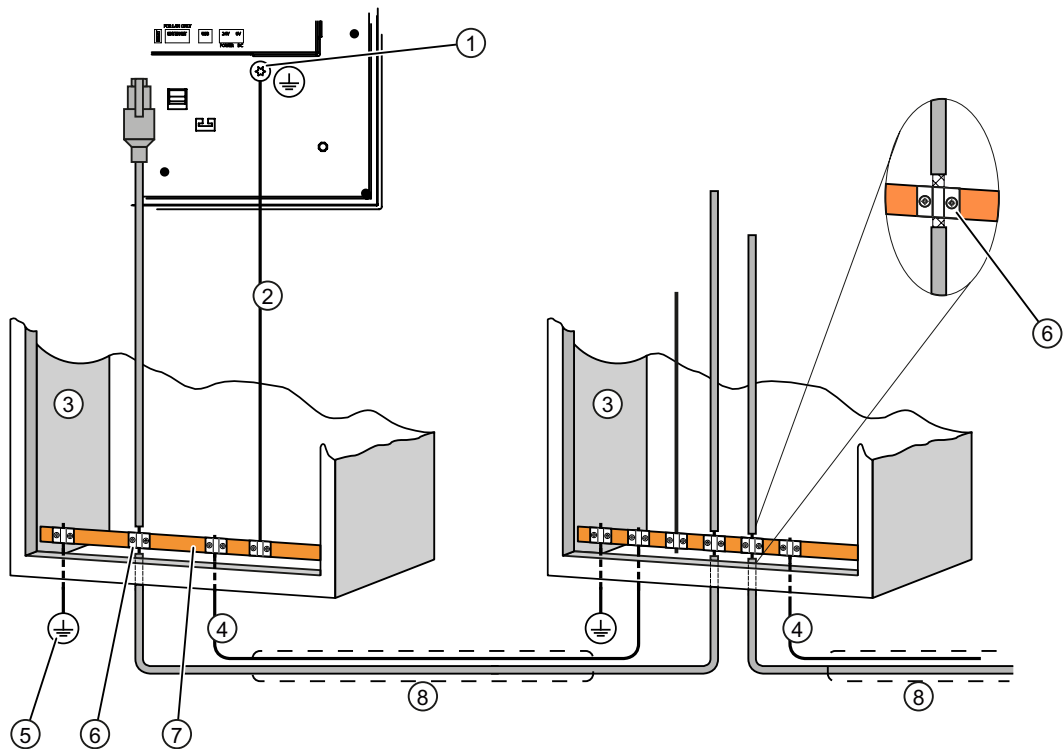

- ① Chassis terminal on the HMI device, example
- ② Equipotential bonding conductor cross-section: 4 mm²
- ③ Control cabinet
- ④ Equipotential bonding conductor cross-section: min. 16 mm²
- ⑤ Ground connection
- ⑥ Cable clip
- ⑦ Equipotential bonding rail
- ⑧ Parallel routing of the equipotential bonding conductor and data cable

CAUTION

Damage to the interface modules possible

Cable shielding is not suitable for equipotential bonding.

Use only the prescribed equipotential bonding conductors. The equipotential bonding conductor ④ must not be less than 16 mm². The interface modules may otherwise be damaged or destroyed.

4.3.4 Connecting the power supply

Wiring diagram

The following figure shows the connection between the power supply and HMI device.

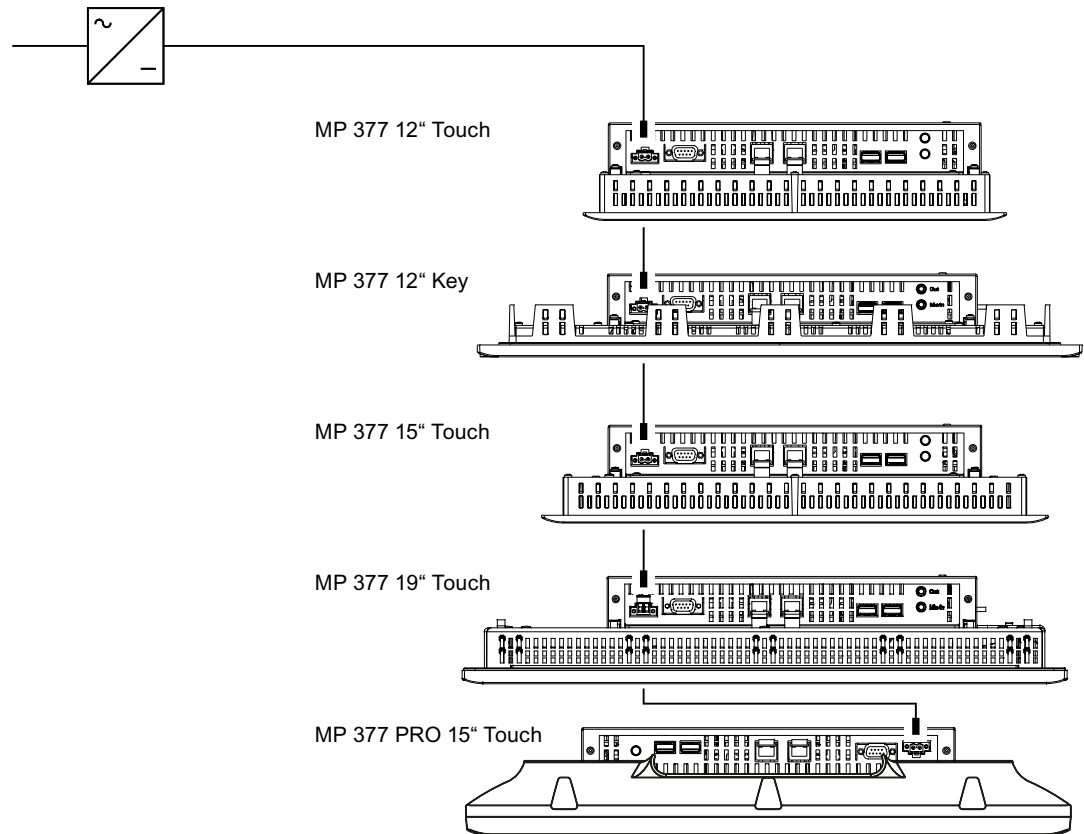

Note when connecting

The mains terminal for connecting the power supply is contained in the accessory kit. The mains terminal is designed for cables with a maximum cross-section of 1.5 mm².

Connecting the mains terminal

NOTICE
Damage Do not tighten the screws of the power supply terminal if it is plugged into the HMI device. The pressure from the screwdriver may otherwise damage the HMI device socket. Only connect the wires when the mains terminal is withdrawn.

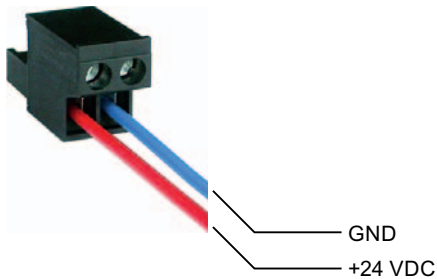

Connect the power supply terminal to the cables of the power supply as shown in the figure above. Ensure that the lines are connected properly to the correct terminals. Refer to the label for the contact pins on the rear of the HMI device.

Reverse polarity protection

The HMI device is equipped with a reverse polarity protection circuit.

Connecting the power supply

CAUTION
Safe electrical isolation Use only 24 VDC power supply units with safe electrical isolation in accordance with IEC 60364-4-41 or HD 384.04.41 (VDE 0100, Part 410), e.g. to PELV standard. The supply voltage must be within the specified voltage range. Otherwise, malfunction at the HMI device cannot be ruled out. Applies to non-isolated plant configurations: Connect the GND 24 V connection from the 24 V power supply output to equipotential bonding for uniform reference potential. You should always select a central point of termination.

See also

Connecting an uninterruptible power supply (Page 67)

4.3.5 Connecting an uninterruptible power supply

Connection graphic

The following figure shows the connection between the uninterruptible power supply and HMI device. The uninterruptible power supply is connected to the 24-V input and one of the HMI device's USB ports.

When connected to the HMI device's USB port, the following uninterruptible power supplies are supported:

SITOP DC UPS modules as of a rated power value of 6 A, e.g. 6EP1931-2DC42

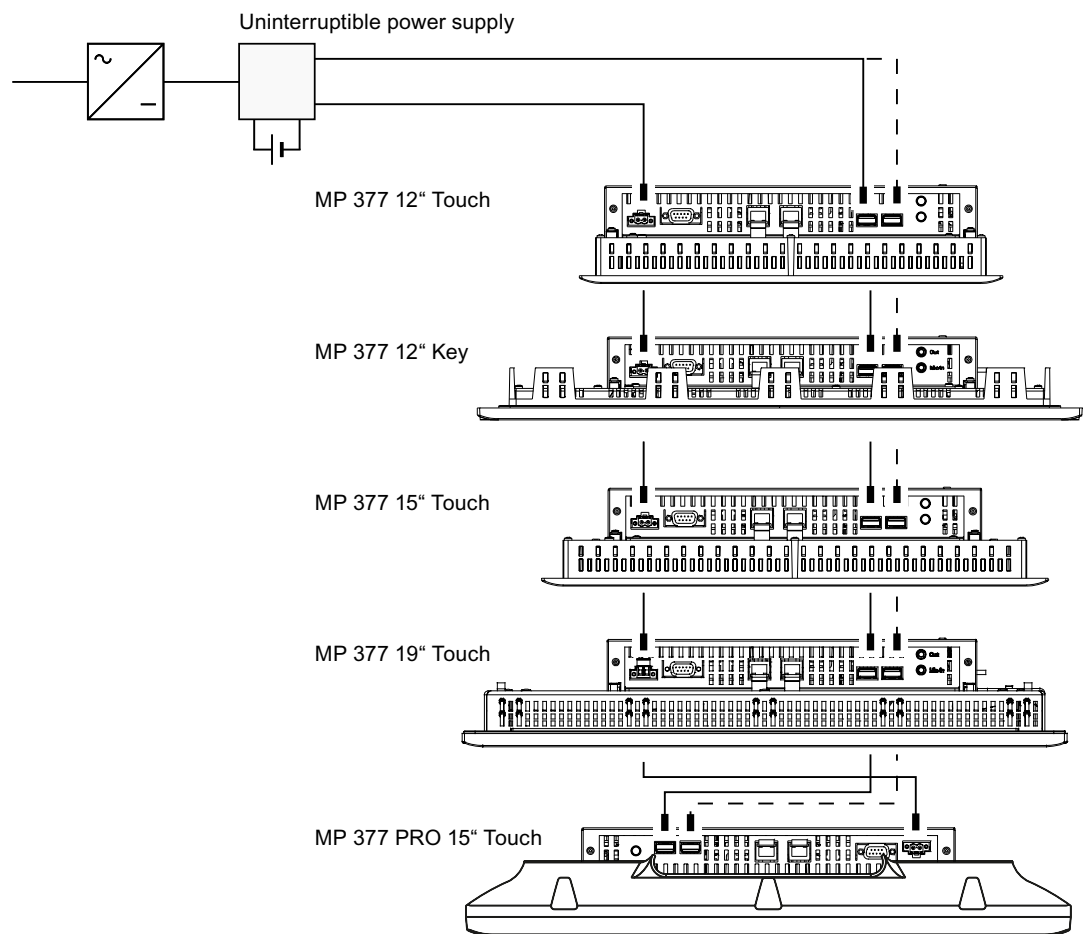

Note

Observe all the notes relating to connecting a power supply.

See also

Connecting the power supply (Page 65)

4.3.6 Connecting the PLC

Wiring diagram

The following figure shows the connection between the PLC and HMI device.

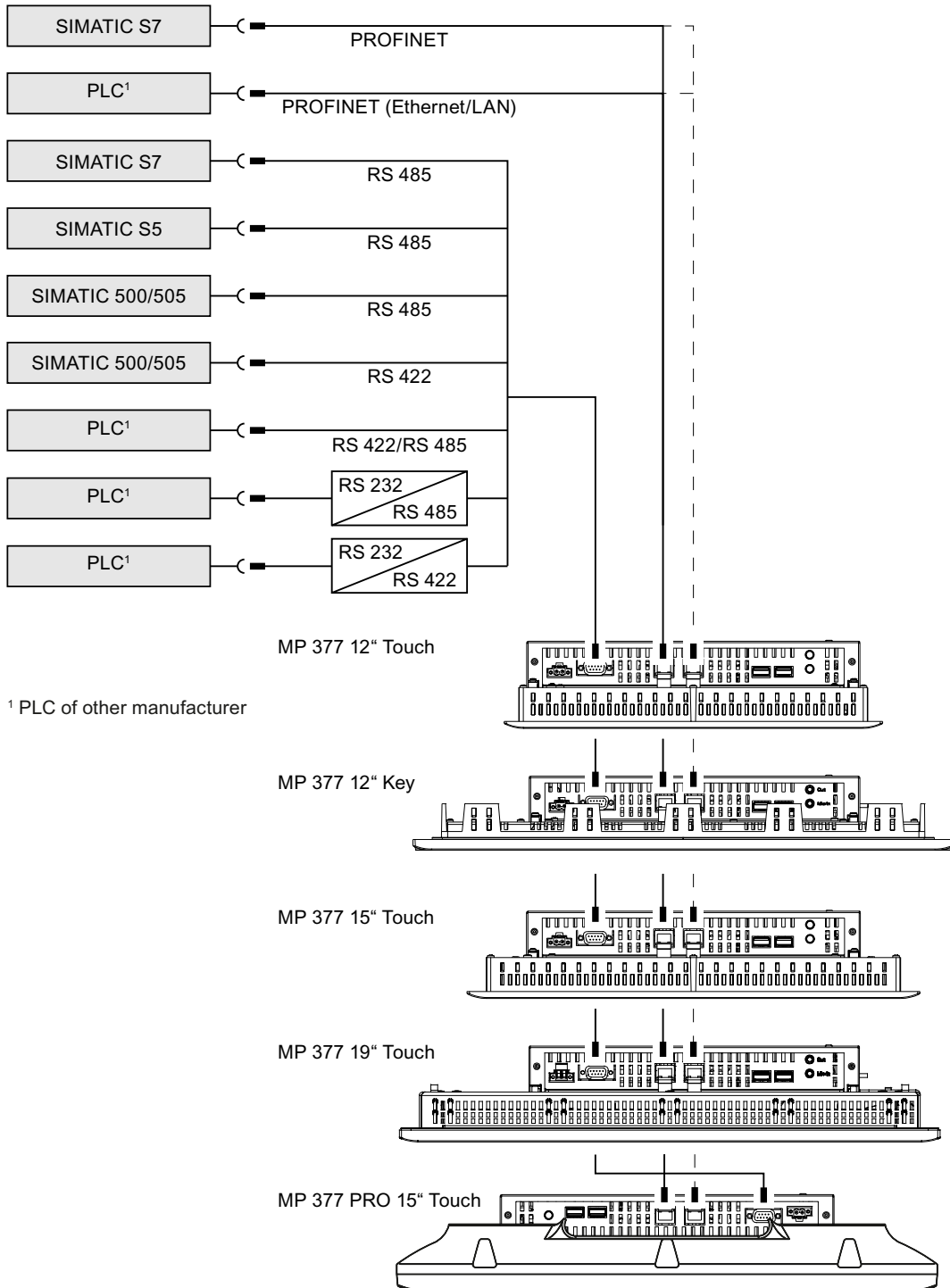

NOTICE

Approved cable

If you do not use approved cables to connect a SIMATIC S7 controller, you may experience malfunctions.

Only use approved cables to connect a SIMATIC S7 controller.

Standard cables are available for the connection. You can find additional information on this in the Internet at "<http://mall.automation.siemens.com>".

Connecting PROFINET

NOTICE

Damage to the HMI device

Only connect the HMI device to public Ethernet networks using a switch or comparable device.

PROFINET IO communication

For instructions regarding the installation of PROFINET networks, refer to the "PROFINET System Description" manual.

Note the following for the MP 377 PRO 15" Touch:

Use an angled tool, such as an Allen wrench, to loosen the latch of the RJ45 connector for PROFINET.



Configuring an RS-422/RS-485 port

A DIP switch S1 for the configuration of the RS-422/RS-485 port is located on the rear of the HMI device.

In the factory state, the DIP switch is set for communication with the SIMATIC S7 PLC via RS 485.

Note

Note the diagrams of DIP switch settings on the rear panel of the HMI device.

The following table shows the DIP switch settings. The send and receive direction is toggled internally using the RTS signal.

Communication	Switch setting	Meaning
RS 485		No RTS on connector, <ul style="list-style-type: none"> • During data transfer between the PLC and HMI device • During data transfer between the HMI device and PC (delivery condition)
		RTS on pin 4, same as PLC, for example for commissioning
		RTS on pin 9, same as programming device, for example for commissioning
RS 422		RS-422 port is active.

4.3.7 Connecting the configuration PC

Wiring diagram

The following figure shows the connection between the configuring PC and HMI device.

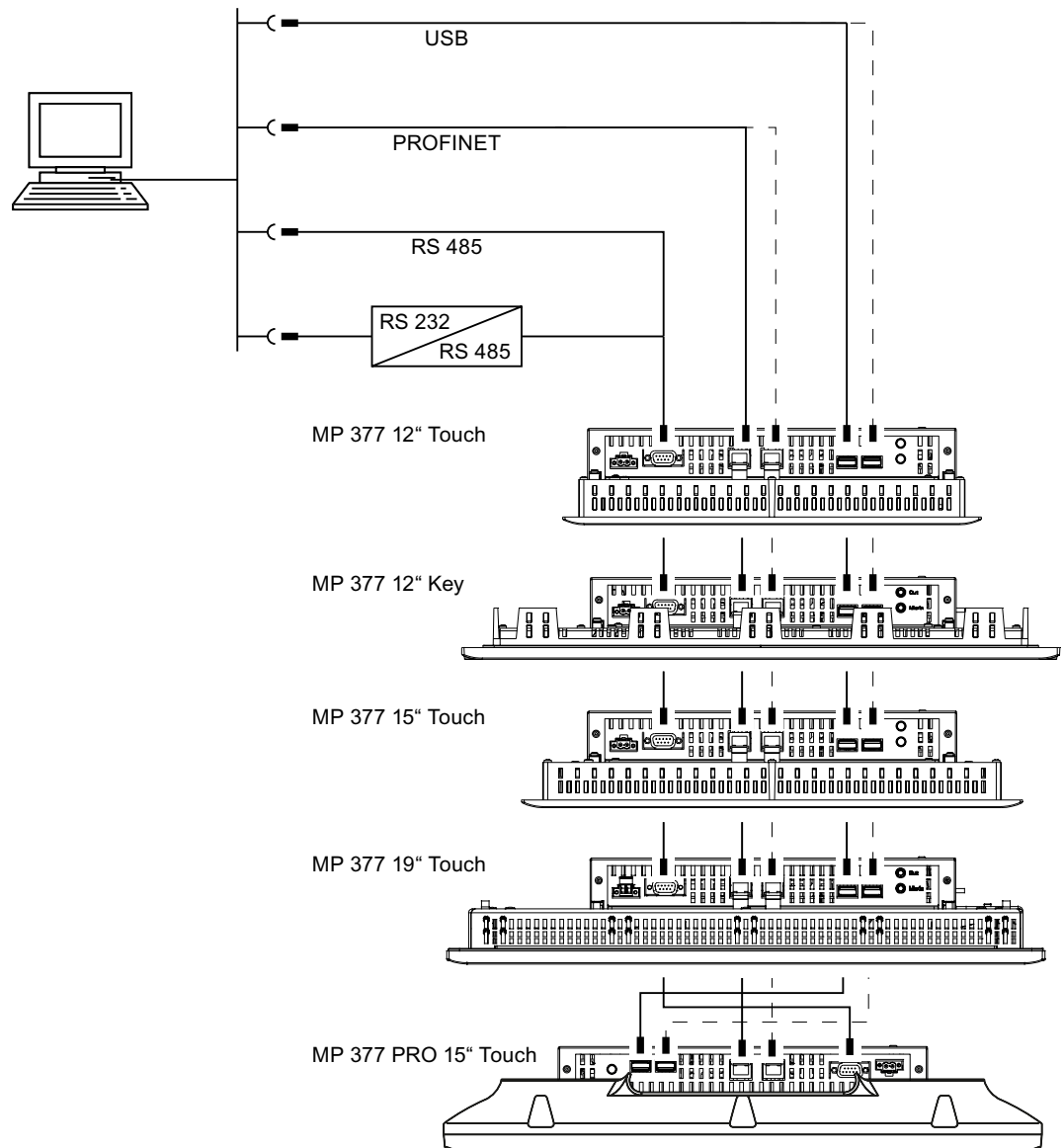

The ports are described in the specifications.

For the RS-485 to RS-232 conversion, you can order the PC/PPI cable from Siemens AG using order number 6ES7 901-3CB30-0XA0.

Configuring the PC/PPI cable

Use the DIP switches to configure the transfer rate of the PC/PPI cable.

Note

Set a lower bit rate if the connection is lost during the operating system update. If you use a higher bit rate, you must use the PC/PPI cable version 3 or higher. The version code is printed on the cable ("E stand 3," for example, corresponds to version 3).

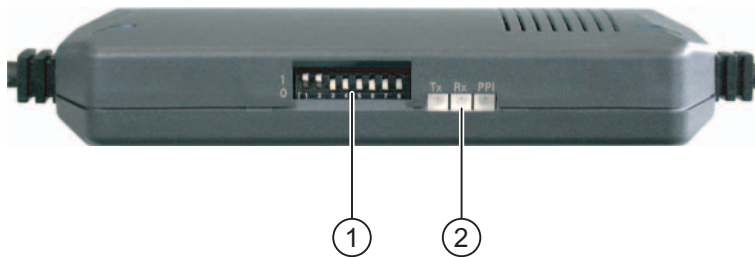

- ① DIP switch
- ② LEDs

Set DIP switches 1 to 3 to the same bit rate as in WinCC flexible. DIP switches 4 to 8 must be set to "0".

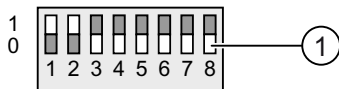

- ① DIP switch

The following bit rates can be set:

Bit rate in Kbps	DIP switch 1	DIP switch 2	DIP switch 3
115.2	1	1	0
57.6	1	1	1
38.4	0	0	0
19.2	0	0	1
9.6	0	1	0
4.8	0	1	1
2.4	1	0	0
1.2	1	0	1

In the figure, the bit rate is set to 115.2 Kbps.

Note when connecting

NOTICE
USB connection sequence Observe the following sequence when connecting by USB: 1. HMI device 2. PC
USB host-to-host cable Use only the driver for the USB host-to-host cable that is included in the WinCC flexible package. Never use the driver supplied with the USB host-to-host cable.

Note

Updating the operating system

If there is no serviceable HMI device image on the HMI device, you can only update the operating system by restoring the factory setting. When restoring the factory settings, connect the PC to the HMI device by PROFINET.

HMI device changeover

If you connect more than one HMI device with the same IP address in succession to a single configuring PC, you need to ping the configuring PC once from the HMI device on each changeover of the HMI device.

Note for MP 377 PRO 15" Touch

Use an angled tool, such as an Allen wrench, to loosen the latch of the RJ45 connector for PROFINET.



4.3.8 Connecting a USB device

Below are examples of devices you can connect to the USB port of the HMI device:

- External mouse
- External keyboard
- Printer
- USB memory stick
- Industrial USB Hub 4

Industrial USB hub 4 can be obtained using order number 6AV6671-3AH00-0AX0.

Note when connecting

NOTICE
Functional problem with USB port If you connect an external device with a 230-V power supply to the USB port without using an non-insulated installation, you may experience functional problems. Ensure a non-insulated installation.
Excessive rated load on port A USB device with too high a power load may possibly cause functional problems. Observe the values for the maximum load of the USB interface. You will find the values in the section "Technical specifications" (Page 284).

4.3.9 Connecting a printer

Wiring diagram

The following figure shows the connection between the printer and HMI device.

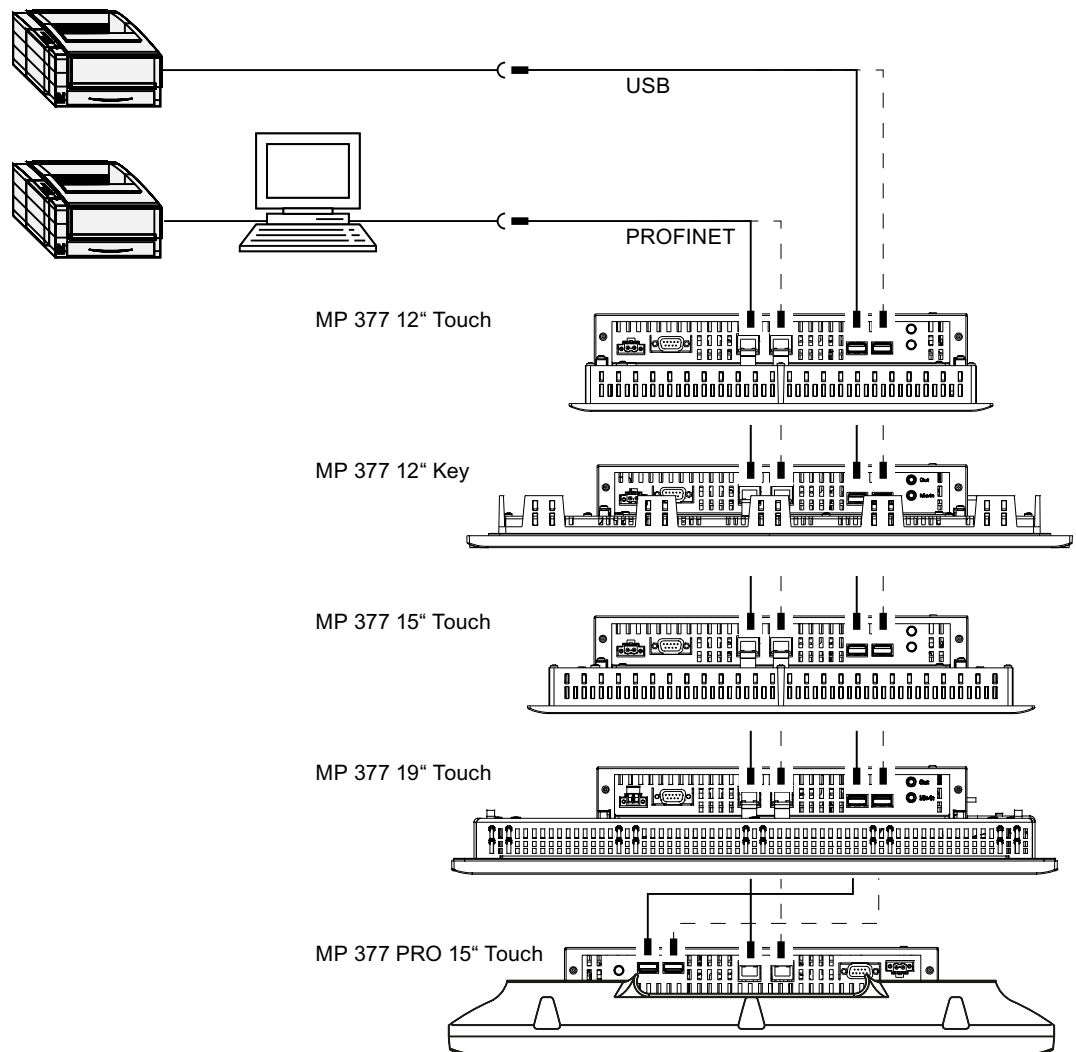

Note when connecting

NOTICE
Data exchange cables If you use cables without a metallic netting shield between the HMI device and printer, you may experience functional problems. Only use cables with metal-braided shielding grounded at both ends for connecting the HMI device and printer.

Note

Some printers may require the ASCII character set used in the project to also be defined on the printer.

You can find the list of current printers and required settings for HMI devices in the Internet at "<http://support.automation.siemens.com/WW/view/en/11376409>".

Observe the supplied printer documentation when you connect the printer.

4.3.10 Connecting an audio device

You can connect an active speaker or another audio amplifier to the HMI device's "Line Out" port.

Note

The "Micro" and "Line In" ports are provided for future applications.

The microphone and audio source share one port.

4.4 Switching on and testing the HMI device

Procedure

Proceed as follows:

1. Switching on the power supply.

The screen lights up after power is switched on. A progress bar is displayed during startup.

If the HMI device fails to start, you have probably crossed the wires on the mains terminal. Check the connected wires and change their connection. The Loader opens after the operating system has started.

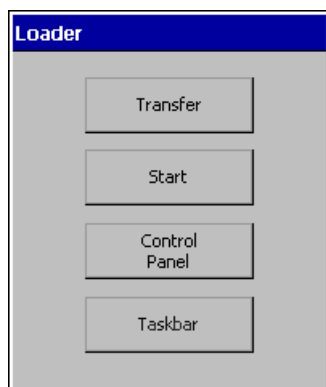

The HMI device automatically switches to "Transfer" mode during initial startup under the following conditions:

- No project is loaded on the device.
- At least one data channel has been configured.

During this process the following dialog appears:

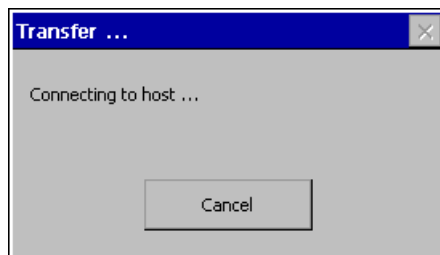

2. Press "Cancel" to stop the transfer.

Result

The Loader appears again.

Note

When restarting the system, a project may already be loaded on the HMI device. The project will then start after an adjustable delay or when you press the "Start" button.

Use the relevant operating element to close the project.

Refer to your plant documentation to find any additional information on this topic.

Function test

Perform a function test following commissioning. The HMI device is fully functional when one of the following states is indicated:

- The "Transfer" dialog is displayed.
- The Loader is displayed.
- A project is started.

Shutting down the HMI Device

Terminate the project at the HMI device before switching it off.

You have the following options for switching off the HMI device:

- Switch off the power supply.
- Remove the mains terminal from the HMI device.

See also

Configuring the data channel (Page 136)

4.5 Securing the cables

4.5.1 Securing cables on the MP 377 mounting device

After the power-on test, to ensure strain relief, use cable ties to secure the connected cables to the marked fixing elements.

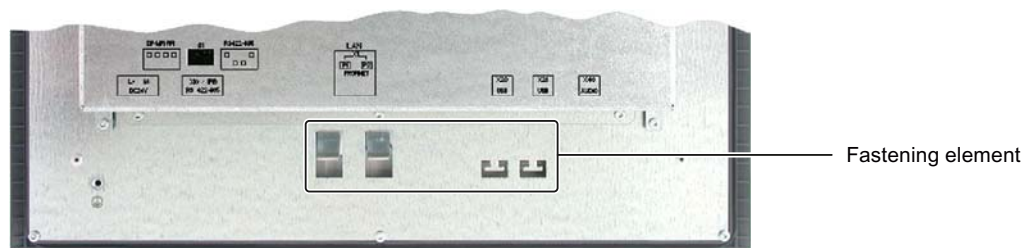

4.5.2 Securing cables on the MP 377 PRO

After the power-on test, use cable ties to secure the connected cables to the marked clasps to ensure strain relief.



4.6 Closing the housing rear wall of MP 377 PRO

Requirement

- All cables are connected.

Procedure

Proceed as follows:

1. Check that the seal is properly seated on the housing.

NOTICE
IP65 degree of protection at risk
If the seal on the rear wall of the housing is damaged, the IP65 degree of protection is at risk. This is a repair case. Proceed as described in the section Spare parts and repairs (Page 274).

2. Position the housing rear wall on the housing.

Ensure the housing rear wall cannot fall down.

NOTICE
Do not exceed the permissible torque
If you tighten up the screws with a torque of > 1.2 Nm, you could damage the thread in the housing.
Alternatively, tighten the screws using a maximum torque of 1.2 Nm.

3. Use an Allen key, size 2, to remove the 10 screws ① of the housing rear wall.



Operator controls and displays

5.1 Front operator controls

MP 377 Touch

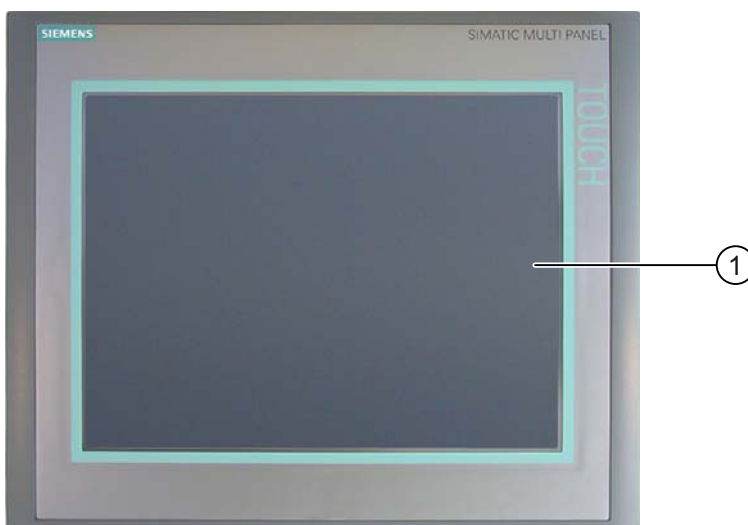

- ① Display with touch screen

The MP 377 Touch is operated via the touch screen. All operating elements required for operator input are displayed on the touch screen once the HMI device has started.

NOTICE

Unintentional action possible

Do not carry out several operations simultaneously. You may otherwise trigger an unintentional action.

Always touch only one operating element on the screen

Damage to the touch screen possible

Never touch the touch screen with pointed or sharp objects. Avoid applying excessive pressure to the touch screen with hard objects. Both these will substantially reduce the useful life of the touch screen and even lead to total failure.

Always operate the HMI touch screen with your fingers or with a touch pen.

MP 377 12" Key

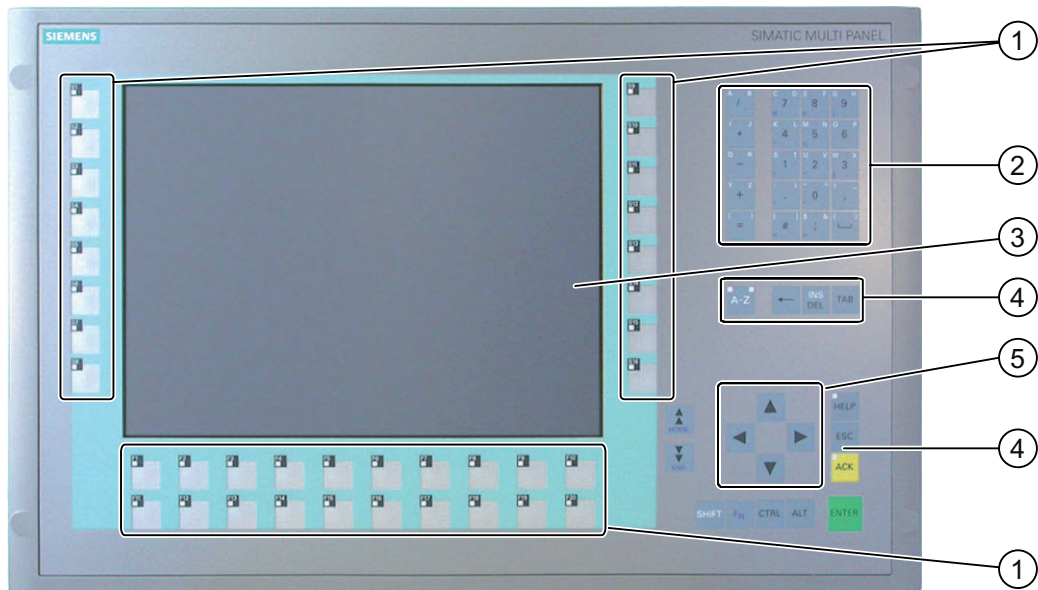

- ① Function keys with LED
- ② System keys - alphanumeric keys
- ③ Display
- ④ System keys – control keys
- ⑤ System keys - cursor keys

The MP 377 12" Key is operated using the system keys and the function keys.

The function assigned to a specific function key is defined during configuration. The function keys have no function prior to the project being opened.

NOTICE
Unintentional action possible Do not carry out several operations simultaneously. You may otherwise trigger an unintentional action. Do not press more than two keys simultaneously
Damage to the keyboard possible Using hard instruments to press the keys considerably reduces the service life of the key mechanism. Only use your fingers to operate the HMI device keys.

5.2 Inserting a memory card

Introduction

The following can be saved to the memory card of the HMI device:

- Backup of the HMI device
- Logs
- Recipes
- Operating system
- Applications
- Other data such as video files, Word, Excel or PDF files

The memory card can be inserted during operation.

Note

The multimedia card of the SIMATIC S7 PLC cannot be used.

Procedure

Proceed as follows:

1. Insert the memory card into the relevant slot.

When inserting the memory card, please note that it can only be inserted in the slot when the front side of the memory card is visible.

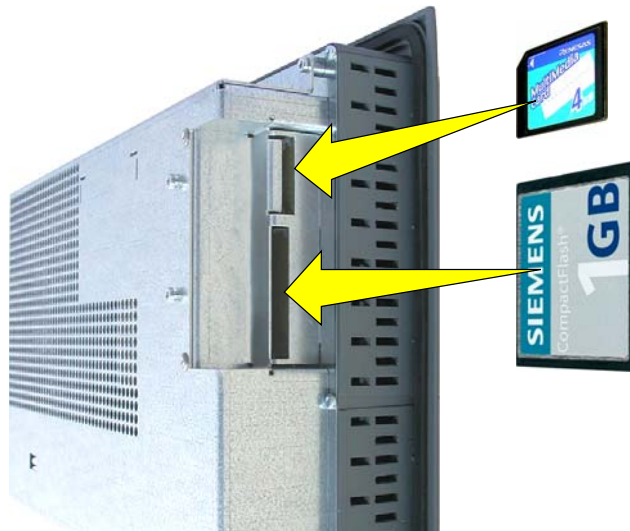

2. Check that the memory card is properly seated.

See also

Securing memory card (Page 84)

5.3 Securing memory card

Introduction

The HMI device is designed for the tough conditions experienced in industry. Therefore use the locking bracket to secure the memory card in its slot.

Requirements

A memory card has been inserted.

Procedure

Proceed as follows:

1. Loosely screw in the Torx screw ①.

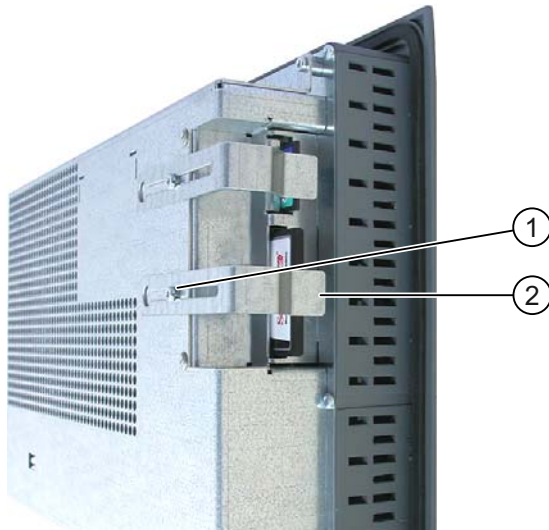

2. Place the locking bracket ② against the memory card.
3. Tighten the Torx screw ①.

Result

The memory card is secure.

5.4 Unplugging the memory card

Introduction

The memory card can be unplugged during operation. Do not remove the memory card while data is being accessed by an application, e.g. during backup or recipe transfer.

Procedure

NOTICE
Loss of data possible The data on the memory card is lost if you attempt to remove it while the HMI device is accessing its data. Do not remove the memory card while data is being accessed. Observe the corresponding alarms on the screen.

Proceed as follows:

1. Unplug the memory card from the memory card slot.
2. Store the memory card in a safe place.

5.5 Labeling the function keys on the MP 377 12" Key

Introduction

You can label the function keys as required for your project. Use the labeling strips for this purpose.

Preprinted key labeling strips may be ordered as accessories, see section Accessories (Page 26).

Note

Do not write on the keyboard to label the function keys.

Printing labeling strips

WinCC flexible comes with a range of labeling strip templates. You can find additional information on the location of the templates in the WinCC flexible online help.

Any printable and writable foil can be used as labeling strips. You can use transparency film, the keyboard membrane of the HMI device is printed on the reverse side. Use transparent foil so that the LEDs of the function keys can be seen.

The permitted thickness of the labeling strip is 0.13 mm. Paper labeling strips are inappropriate.

Dimensions of the labeling strip for the MP 377 12" Key

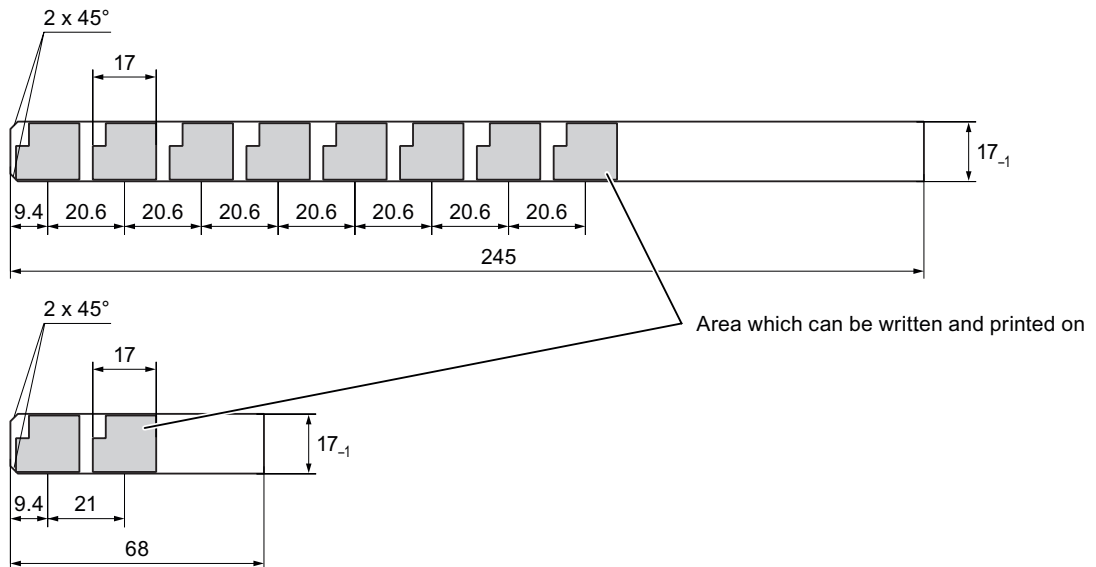

Procedure

Proceed as follows:

1. Edit and then print the template.

You can also print blank templates and label them manually.

2. Apply a fixing spray film to the labeling strips.

The fixing spray ensures that the text is water resistant and does not smear, and that the printer ink on the keyboard membrane does not run.

3. Cut out the labeling strip.

Ensure that the corners are cut according to the diagram shown above as this makes it easier to slide them into the slot.

4. Remove any existing labeling strips.

Note

Wait for the printed labeling strips to dry before you insert them.

5. Slide the labeling strips ② into the slot ①.



6. Slide the labeling strips into the slot up to the stop.

The labeling strip will protrude approximately 3 cm from the slot. The template dimensions for the labeling strips are designed so that the labeling is correctly placed for the function keys. It is not necessary to secure the labeling strip.

When mounting the HMI device, ensure that the labeling strips do not become jammed between the mounting cut-out and the HMI device.

Configuring the operating system

6.1 Loader

Overview

The following figure shows the Loader. The header line contains details of the loader version. These details are not shown in the following figure.

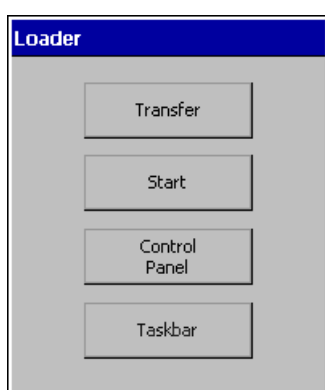

The Loader buttons have the following functions:

- Press the "Transfer" button to set the HMI device to "Transfer" mode.
The transfer mode can only be activated when at least one data channel has been enabled for the transfer.
- Press the "Start" button to start the project on the HMI device.
If you do not perform an operation, the project on the HMI device will automatically start after a delay.
- Press the "Control Panel" button to open the control panel of the HMI device.
You can change various settings in the Control Panel, for example, the transfer settings.
- Press the "Taskbar" button to activate the taskbar with the Windows CE start menu open.

The following figure shows the open start menu.

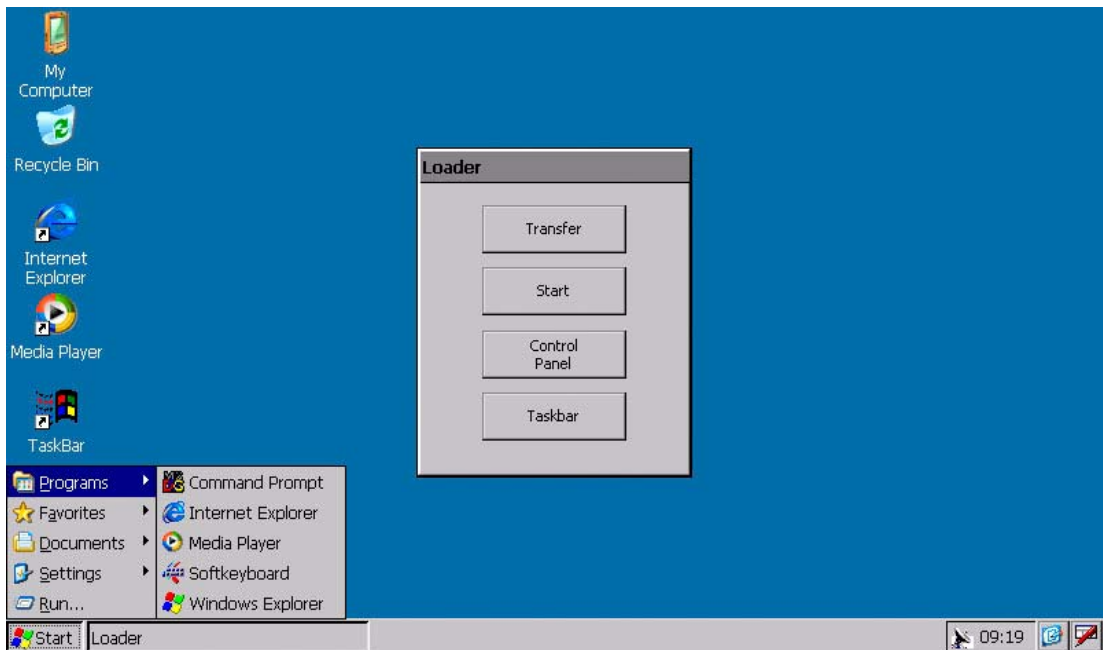

Depending on the software installed, other symbols may be displayed in the desktop's status bar.

Open Loader

The following options are available to open the Loader:





- The Loader appears briefly after starting the HMI device.
- The Loader appears when the project is closed.

If configured, use the relevant operating element to close the project.

For further information on this, refer to your plant documentation.







Key operation in the Loader

The following table shows the key combinations for navigating in the Loader.

Key combination	Function
 ,  , 	The next or previous entry is selected.
 or 	The selected button is operated.















Key operation in the Windows CE interface

The following table shows the key combinations for navigating in the user interface.

Key combination	Function
 + 	The taskbar is activated with the open Windows CE start menu.
 + 	The next active program is displayed.
 + 	The Task Manager is opened.

Key operation in the Explorer

The following table shows the key combinations for navigating in the Explorer.

Key combination	Function
	<ul style="list-style-type: none"> • Toggles the active window. • Toggles between the Windows CE Desktop and the window.
 + 	Selects the first entry.
 + 	Selects the last entry.
 + 	Selects everything, if the left LED of the key  lights up
	Activates the menu bar.
	Changes to the higher level.
 + 	Opens the shortcut menu.
 + 	Displays the properties.

Protection against unauthorized use

You can protect the control panel against unauthorized access by using a password.

You can also protect the taskbar and the Desktop with the help of SecureMode. If the HMI device is protected, "secure mode" is displayed on the Windows CE desktop. You can find additional information on this in the section "Setting up and disabling SecureMode (Page 94)".

The "Transfer" and "Start" buttons can always be used without having to enter a password.

Password protection prevents maloperation. This increases the security of the system or equipment because settings for the current project can only be changed after entering the password.

NOTICE

Loss of data possible

If the password is no longer available, you can only cancel password protection by updating the operating system. All data on the HMI device will be deleted when you update the operating system.

Back up the HMI device's data.

Internet Explorer

Internet Explorer for Windows CE is installed on the HMI device.



Note

Internet Explorer for Windows CE and the Internet Explorer version which can run on a PC differ in terms of functionality.

Internet Explorer for Windows CE has separate proxy settings that are independent of the settings in the control panel of the HMI device.

You can find additional information at the Microsoft Website.

Media Player

Media Player for Windows CE is installed on the HMI device. Media Player is used, for example, to play video sequences for maintenance and servicing.



Media Player supports the following formats:

- WMA
- MPEG

Note

Media Player for Windows CE and the Media Player version that can run on a PC differ in terms of functionality.

You can find additional information at the Microsoft Website.

6.2 Setting up and disabling SecureMode

Overview

You can protect the control panel against unauthorized access with a password. You can also protect the taskbar and the Desktop with the help of the SecureMode.

Function of SecureMode

You set up SecureMode by setting up a password in the control panel. SecureMode is then automatically activated. The label "secure mode" is displayed in the Windows CE Desktop.

If you now want to use a function on the taskbar or Desktop, you have to enter the password.

When you have entered the password, the label "secure mode" is no longer displayed. All the functions of the taskbar and Desktop can now be used freely. To reactivate SecureMode, double-click the  icon on the Desktop. The "secure mode" label is displayed again. The HMI device is protected again.

Canceling SecureMode



To completely cancel SecureMode, delete the password.

6.3 Viewer

Introduction

You can use ProSave to install viewers for various data formats. You can tell which viewers are installed by a symbol on the desktop and from the Start menu under "Programs".

The following viewers can be installed:

Viewer	Icon
PDF Viewer	
Word Viewer	
Excel Viewer	

Functional scope

The viewers can read and print the following file formats:

Viewer	Readable file formats
PDF Viewer	PDF
Word Viewer	DOC, RTF
Excel Viewer	XL*

All viewers share a Zoom function. The Excel Viewer also offers the following functions:

- Switch between spreadsheet tabs
- Split the spreadsheet
- Change line height and column width

6.4 Control Panel

6.4.1 Overview

The HMI device's Control Panel is similar to the control panel on a PC.

The Control Panel looks like this:

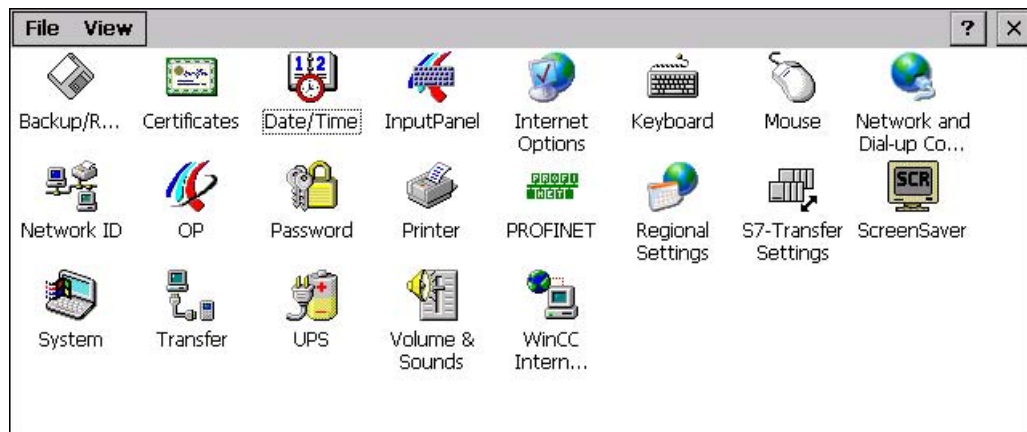

The control panel can be used to modify the following settings:

- Date and time
- Screen saver
- Regional settings
- Transfer settings
- Network settings
- Delay time
- Password

6.4.2 Opening the Control Panel



Introduction

The HMI device Control Panel can be opened as follows:

- Independently of a running project
 - Press the "Control panel" button in the loader.
 - By calling up from the Windows CE start menu.
- With active project
 - An operating element must be configured to open the control panel for this purpose.

Procedure – open the Control Panel via the Start menu

Proceed as follows:

1. Open the Windows CE start menu.
 - Procedure using the keys:
Select the  +  key combination.
 - Procedure using the touch screen:
Press the  key twice on the alpha-numeric VDU keyboard.
2. Select "Settings > Control panel".















Result







The control panel is opened.

6.4.3 Reference for functions

Overview of functions

The following table shows the settings in the Control Panel.

Icon	Functions	Tab / entry	
	Saving and restoring with external storage device	–	
	Importing, displaying and deleting certificates	"Stores"	
	Setting the date and time	"Date/Time"	
	Configuring the screen keyboard	–	
	Changing the browser startup page and general browser settings	"General"	
	Changing connection and proxy server settings	"Connection"	
	Changing cookie settings	"Privacy"	
	Changing privacy settings	"Advanced"	
	Setting the character repeat for the keyboard	"Repeat"	
	Setting the double-click	"Double-Click"	
	Parameterizing the LAN connection	"ERTEC400"	
	Setting the IP address	"ERTEC400 Ethernet Driver' Settings"	"IP Address"
	Set name server	"ERTEC400 Ethernet Driver' Settings"	"Name Servers"
	Changing the logon data	"Identification"	
	Backup registry information	"Persistent Storage"	
	Changing monitor settings	"Display"	
	Displaying information about the HMI device	"Device"	
	Restarting the HMI device	"Device"	
	Touch screen calibration ¹⁾	"Touch"	
	Activate memory management	"Memory Monitoring"	
	Changing password protection	"Password Settings"	
	Changing the printer properties	–	
	Changing the PROFINET IO setting	–	
	Changing regional settings	"Regional Settings"	
	Changing the number format	"Number"	
	Changing the currency format	"Currency"	
	Changing the time format	"Time"	
	Changing the date format	"Date"	

Icon	Functions	Tab / entry
	Changing transfer settings	"MPI"
	Changing the PROFIBUS DP transfer settings	"PROFIBUS"
	Setting the screen saver	–
	Reducing the backlighting	
	Displaying the system information	"General"
	Displaying memory information	"Memory"
	Setting the device name of the HMI device	"Device Name"
	Configuring the data channel	"Channel"
	Setting the delay time	"Directories"
	Setting the uninterruptible power supply	"Configuration"
	State of uninterruptible power supply	"Current Status"
	Setting operation feedback with key and touch screen operation	"Volume"
	Setting operation feedback with key operation	
	Setting acoustic signal for inadvertent operations	
	Assigning sounds to events.	"Sounds"
	Changing e-mail settings ²⁾	"Email"

1) Only with MP 377 Touch

2) Additional tabs may appear in the "WinCC flexible Internet Settings" dialog. This depends on the options that have been enabled for network operation in the project.

6.4.4 Operating the Control Panel

6.4.4.1 Overview

Operator input options

The hardware of the HMI device determines, which of the following operator control options are available:

- Touch screen

The operating elements shown in the dialogs are touch-sensitive. Touch objects are basically operated in the same way as mechanical keys. You activate operating elements by touching them with your finger. To double-click them, touch an operating element twice in succession.

- HMI device keyboard

The operating elements shown in the dialogs are selected and operated using the keys of the HMI device.

- External USB keyboard
- External USB mouse

Entries using an external keyboard

An external keyboard can be used to operate the Control Panel in exactly the same way as the HMI device keyboard. Use the keys of the external keyboard which correspond to the HMI device keys in the description.

Operator entries using an external mouse

An external mouse can be used to operate the Control Panel in exactly the same way as the HMI device touch screen. Click the described operating elements with the mouse.

6.4.4.2 Operation using the touch screen

Introduction



The control panel is operated with the HMI device touch screen or a connected mouse.

Requirements

An active project has been terminated. The Loader appears.

Procedure



Proceed as follows to change settings in the Control Panel:

1. Open the Control Panel with the "Control Panel" button.
2. To open the required dialog, double-click its symbol.
3. Change the tab as required.
4. Make the necessary changes.
Touch the corresponding input object.
 - Use the screen keyboard of the HMI device to enter the new values in the text boxes.
 - Touch a button to operate it.
 - Touch the selection box to open a drop down list box. Touch the required entry from the drop down list box.
 - Touch the check box to activate or deactivate a check box.
 - Touch a radio button to select it.
5. Confirm the selection with the  button or abort the entry with the  button.
The dialog closes.
6. Close the Control Panel with the "" button.
The Loader appears.

Input with the screen keyboard

A screen keyboard is available for data input. The screen keyboard is displayed as soon as you touch a text box. You can also call up the screen keyboard directly from the Control Panel.

Display methods for the screen keyboard

You can change the display method for the screen keyboard and fix the position on the screen. Confirm the entry with the  button or abort the entry with the  key. Either action closes the screen keyboard.

- Numerical screen keyboard



- Alphanumerical screen keyboard









The alphanumerical keyboard is organized in the following two layers:

- Normal level
- Shift level

- Reduced screen keyboard



Changing the display of the screen keyboard

Key	Functions
	Switching between the numerical and alphanumerical keyboard
	Switching between the normal level and Shift level of the alphanumerical screen keyboard
	Switchover to special characters
	Switching from full display to reduced display
	Switching from reduced display to full display
	Close the screen keyboard

6.4.4.3 Operation with the keyboard

Introduction

The Control Panel is operated with the system keys of the HMI device.

Requirements

An active project has been terminated. The Loader appears.

Procedure

Proceed as follows to change settings in the Control Panel:

1. Open the Control Panel.
2. Select the "Control Panel" button in the loader using the cursor keys.
3. Press .

The Control Panel is opened.

4. Select the symbol of the required dialog with the cursor keys.
5. Press  to open the dialog.
6. Change the tab as required.

Press  until the name of the tab is selected. Now switch between the tabs using the cursor keys.



7. Use the  key to return to the input area.

8. Make the necessary changes.

To do this, highlight the corresponding input object using the  key.

– Use the system keys of the HMI device to enter the new values in the text boxes.

– To operate a button, select the button with the cursor keys and then press .

– Open the drop down list boxes with the key combination  + .

Select the required entry from the drop down list box using the cursor keys.

Confirm the selected entry by pressing .

– Press  to activate or deactivate a check box.

– Select a radio button from a group using the cursor keys.

9. Confirm your entries with  or discard your entries with .

If you have selected an input object, you first have to complete entry.

The dialog closes.

10. Close the Control Panel.

Press the  key to do this.

The control panel menu is opened.

11. Select the "Close" entry using the cursor keys.







12. Press .

The Loader appears.







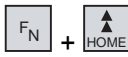

Control keys

The following tables show the control keys used to select and operate the control panel.





- Select operating elements

Key	Functions	Description
 	Tabulator	Selects the next/previous operating element in the tab sequence.
   	Cursor keys	Selects the next operating element to the left, right, above or below the current screen object. Navigates in the operating element.

- Using operating elements

Key	Functions	Description
	Scroll back	Scrolls back a page in a list.
	Scroll to the beginning	Scrolls to the beginning of a list.
	Scroll forward	Scrolls one page forward in a list.
	Scroll to the end	Scrolls to the end of a list.
	ENTER key	<ul style="list-style-type: none"> • Operates a button. • Accepts and ends an entry.
	Cancel	<ul style="list-style-type: none"> • Deletes the characters of a value entry and restores the original value. • Closes the active dialog.
	Delete characters	Deletes the character to the right of the current cursor position.
	Delete characters	Deletes the character to the left of the current cursor position.
	Open drop down list box	Opens a drop down list box.
	Accept value	Accepts the selected value in the drop down list box without closing the list.

Enter key combinations

Key	Functions	Purpose
	Toggle key assignment	<p>Toggles the assignment for a key with multiple assignment.</p> <ul style="list-style-type: none"> No LED is lit The number assignment is enabled. Pressing the button once toggles to letter assignment. An LED is lit The left or right letter assignment is enabled. <p>Each time the key is pressed, the system toggles between the left letter assignment, the right letter assignment and the number assignment.</p>
	Toggle between upper-case and lower-case	Used in key combinations, for example for entering upper-case letters.
	Switch to additional key assignment	<p>Some of the keys contain a blue imprinted key assignment, for example the "%" character.</p> <p>Used in key combinations for the blue key assignment.</p>
	General control function	Used in key combinations
	General control function	Used in key combinations

6.5 Changing settings for operation

6.5.1 Configuring the screen keyboard

Introduction

The details provided below will explain how the screen keyboard can be displayed and positioned.

Requirements

You have opened the "Siemens HMI Input Panel - Options" dialog with the "InputPanel"  icon.

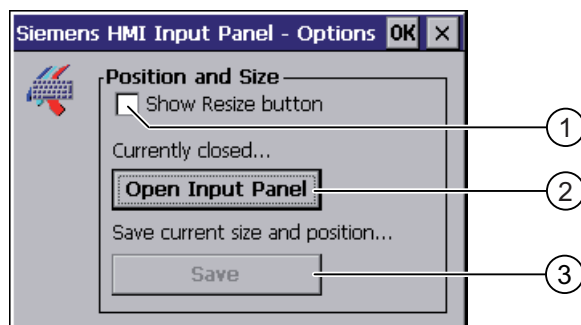



- ① Check box for displaying the  button in the screen keyboard
- ② Button for displaying the screen keyboard
- ③ Button for saving the screen keyboard settings

Procedure

Proceed as follows:

1. If you want to change the size of the screen keyboard, activate the "Show Resize Button" check box.

The  button is displayed in the screen keyboard awaiting opening.
2. If you want to prevent the size of the screen keyboard from being changed, deactivate the "Show Resize Button" check box.

The  button is removed from the screen keyboard awaiting opening.
3. Use the "Open Input Panel" button to open the screen keyboard.
4. If you want to switch between the numerical and alphanumerical screen keyboard, press the  key.

5. If you want to change the position of the screen keyboard, use the mouse pointer to select a free space between the keys.
Release the mouse pointer when the required position has been reached.
6. If you want to increase or decrease the size of the keyboard screen, place your mouse pointer over the button .
7. Adapt the screen keyboard size by dragging it to size with the mouse pointer.
8. Release the mouse pointer when the required size has been reached.
9. If you want to save the settings, press the "Save" button.
10. Confirm your entries.
The dialog closes.

Result

The screen keyboard settings have been modified.

6.5.2 Setting the character repeat

Introduction

The details provided below will explain how to set the character repetition and the associated delay for the keyboard and/or screen keyboard.

Requirements

You have opened the "Keyboard Properties" dialog with the "Keyboard"  icon.

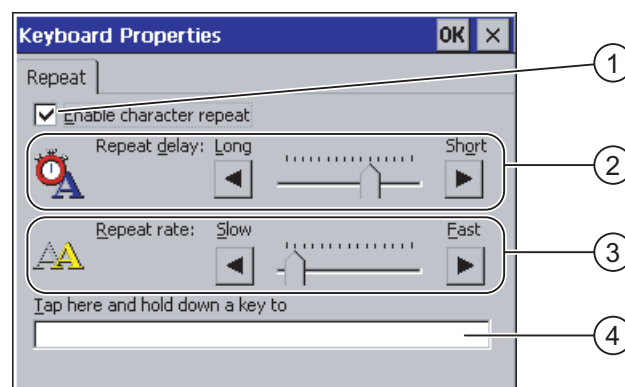

- ① Check box for activating the character repeat
- ② Slider control and buttons for the delay time before character repeat
- ③ Slider control and buttons for the rate of the character repeat
- ④ Test field

Procedure

Proceed as follows:

1. If you want to enable character repetition, activate the "Enable character repeat" check box.
2. If you want to change the delay, press a button or the slider in the "Repeat delay" group.
Moving the slider to the right will shorten the delay. Moving to the left will extend the delay.
3. If you want to change the repeat rate, press a button or the slider in the "Repeat rate" group.
Moving the slider to the right will shorten the repeat rate. Moving to the left will extend the repeat rate.
4. Check the settings.

Procedure using the touch screen:

- Touch the test field.
The screen keyboard opens.
- Move the screen keyboard as needed.

Procedure using the keys:

- Select the test field.
5. Press an alphanumeric key and keep the key pressed down.
Check the implementation of the character repetition and the rate of the character repetition in the test field.
 6. If the settings are not perfect, correct them.
 7. Confirm your entries.
The dialog closes.

Result

The character repetition and delay are set.

6.5.3 Setting the double-click

Introduction

You can start applications in the Control Panel and in Windows CE with a double-click. A double-click corresponds to two brief touches in sequence.

In the "Mouse Properties" dialog, make the following adjustments for touch screen operation and operation with external mouse:

- Interval between touch contacts on the touch screen
- Interval between mouse clicks

Requirements

You have opened the "Mouse Properties" dialog with the "Mouse"  icon.

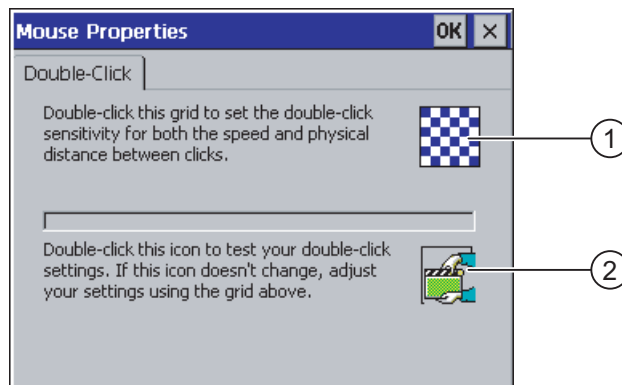

- ① Pattern
- ② Icon

Procedure

Proceed as follows:

1. Click the pattern twice.

After the second click, the colors of the pattern will be reversed and the white fields will change to gray. The time before the second click is saved.



2. Check the double-click.

Click on the icon twice in succession to do this. If the double-click is recognized, the icon is displayed as follows:



3. If the settings are not perfect, correct them.

To do this, repeat steps 1 to 2.

4. Confirm your entries.

The dialog closes.

Result

The double-click adjustment is completed.

6.5.4 Calibrating the touch screen

Introduction

Depending on the mounting position and viewing angle, it is possible that parallax may occur when operating the touch screen. In order to prevent any operating errors as a result, calibrate the touch screen again in the startup phase or during runtime.

Requirements

You have opened the "OP Properties" dialog "Touch" tab with the "OP"  icon.



Procedure

Proceed as follows:

1. Click on the "Recalibrate" button.

The following dialog opens:

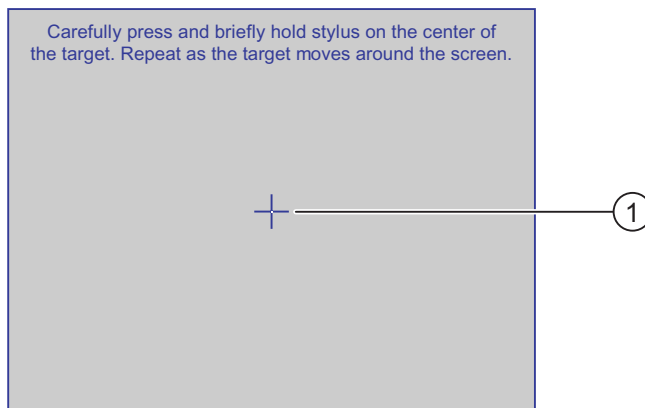

2. Briefly touch the middle of the calibration crosshairs ①.

The calibration crosshairs is then displayed at four more positions.

3. Briefly touch the middle of the calibration crosshairs for each position.

Once you have touched all the positions of the calibration crosshairs, the following dialog appears:

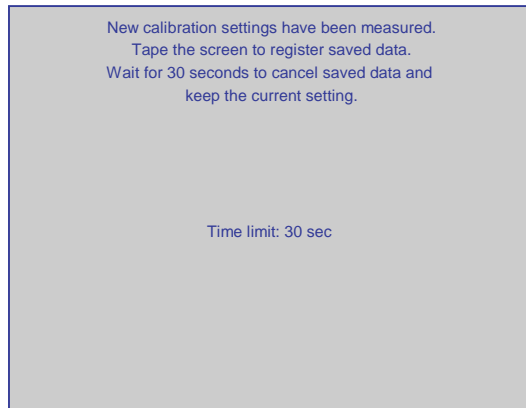

4. Touch the touch screen.

The calibration is saved. The "OP Properties" dialog, "Touch" tab is displayed again. If you do not touch the touch screen within the time shown, your original setting will be retained.

5. Close the dialog.

Result

The HMI device touch screen is calibrated.

6.6 Setting up password protection

Introduction

You can protect access to the Control Panel and the Windows CE taskbar with a password.

Requirements

You have opened the "Password Properties" dialog with the "Password"  icon.

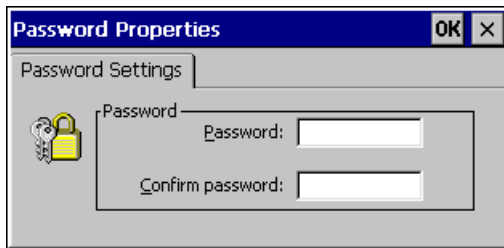

NOTICE

Password not available

If the password is no longer available, you will have to wait for the operating system to be updated again.

- Change settings in the Control Panel
- Use the Windows CE taskbar

All data on the HMI device will be deleted when you update the operating system!

Therefore use the password to protect against loss.

Note

The following characters cannot be used in passwords:

- Blank
- Special characters * ? . % / \ ' "

Procedure

Proceed as follows:

1. Enter a password in the "Password" text box.
2. Repeat the password entry in the "Confirm password" text box.
3. Confirm your entries.

The dialog closes.

Result

You cannot open the Control Panel or Windows CE taskbar without entering a password.

6.7 Canceling password protection

Requirements

You have opened the "Password Properties" dialog with the "Password"  icon.

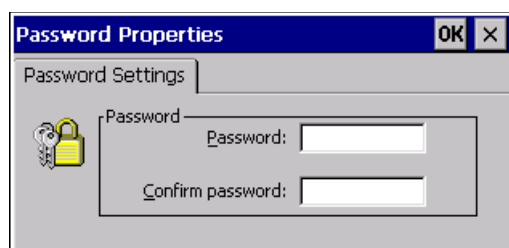

Procedure

Proceed as follows:

1. Delete the entries in the "Password" and "Confirm password" text boxes.
2. Confirm your entries.

The dialog closes.

Result

Password protection for the Control Panel and Windows CE taskbar is canceled and they can be freely accessed.

6.8 Changing HMI device settings

6.8.1 Setting the date and time

Introduction

You can set the date and time on the HMI device. The HMI must be restarted in the following cases:

- You have changed the time zone setting
- You have changed the "Daylight savings time currently in effect" check box setting.

Requirements

You have opened the "Date/Time Properties" dialog with the "Date/Time Properties"  icon.

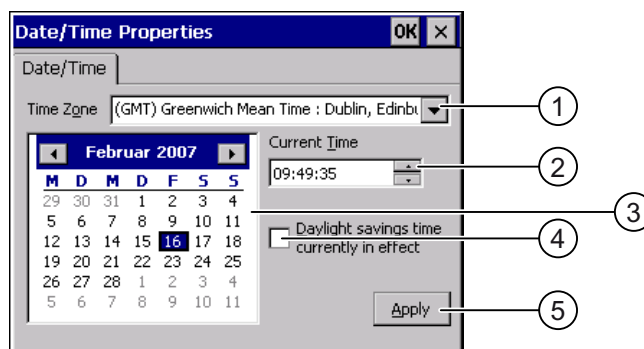

- ① Time zone selection box
- ② Input field for the time
- ③ Date selection box
- ④ "Daylight savings" check box
- ⑤ Button for applying changes

Procedure

Proceed as follows:

1. Select the appropriate time zone for the HMI device from the "Time Zone" selection field.
2. Touch the "Apply" button to confirm your entry.

The time of day shown in the "Current Time" field is adjusted correspondingly to the selected time zone.

3. Set the date in the selection box.
4. Set the current time of day in the "Current Time" text box.

5. Confirm your input by clicking on the "Apply" button.

The values you have set are now in effect.

Note

The system does not automatically switch between winter and summer time.

6. If you want to switch from winter to summer time, activate the "Daylight savings time currently in effect" check box.
When you press the "Apply" button, the time is brought forward by one hour.
7. If you want to switch from summer to winter time, deactivate the "Daylight savings time currently in effect" check box.
When you press the "Apply" button, the time is taken backward by one hour.
8. Confirm your entries.
The dialog closes.

Result

The settings for the date and time of day have now been changed.

Internal clock

The HMI device has an internal buffered clock.

Synchronizing the date and time with the PLC

The date and time of the HMI device can be synchronized with the PLC if this has been configured in the project and the PLC program.

Further information on this subject is available in the "WinCC flexible" system manual.

NOTICE
Time-dependent reactions You have to synchronize the date and time when time-controlled responses are triggered in the PLC by the HMI device.

6.8.2 Changing regional settings

Introduction

In different countries, for example, the date, time and decimal points are displayed differently. You can adjust this display to meet the requirements of different regions.

The country-specific settings apply to the current project. If the project language is changed, the country-specific settings are also changed.

Requirements

You have opened the "Regional and Language Settings" dialog with the "Regional Settings"  icon.



① Region selection box

Procedure

Proceed as follows:

1. Select the region from the selection box.
2. Change to the "Number", "Currency", "Time" and "Date" tabs and set the selection boxes to the desired settings.
3. Confirm your entries.
The dialog closes.

Result

The HMI device's regional settings have been changed.

6.8.3 Backup registry information

Registry information and temporary data

You can install and uninstall your own programs on the HMI devices under Windows CE. You must save the registry settings after installation or uninstallation.

You can save the following data to the flash memory:

- Registry Information
- Temporary files

Restoring the file system of a memory card

If memory cards are used, the file system on the memory card may become damaged, perhaps due to a power failure. The HMI device detects the defective file system on start-up or when the memory card is inserted. The HMI device can restore the file system automatically or on request.

Requirements

You have opened the "OP Properties" dialog, "Persistent Storage" tab with the "OP"  icon.

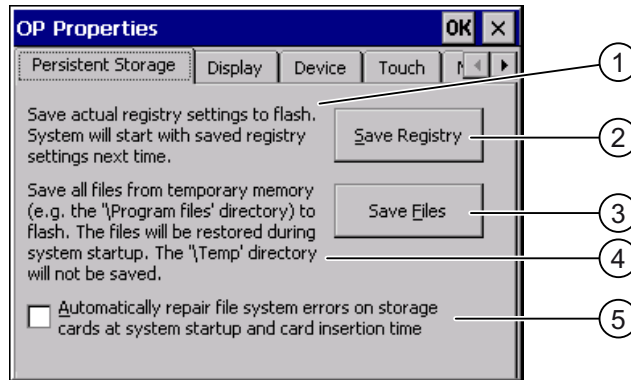

- ① Significance of the text:
Saves the current registry information to the flash memory. The HMI device loads the saved registry information the next time it boots.
- ② Button for saving registry information
- ③ Button for saving temporary files
- ④ Significance of the text:
Saves all the files in temporary storage to the flash memory (for example, from the "Program Files" directory). These files are written back when the HMI device is started. The "\\Temp" directory is not saved.
- ⑤ Automatically restores the file system on the memory card when the HMI device starts up and when a memory card is inserted.

Procedure

Proceed as follows:

1. If you want the system to be restored automatically, activate the "Automatically repair file system errors ..." check box.
If the check box is unchecked, the system is only restored once prompted to do so.
2. Click on the necessary buttons.
3. Confirm your entries.
The dialog closes.

Result

The HMI device uses the saved registry information the next time it starts. The temporary files are copied back.

6.8.4 Changing monitor settings

Requirements

You have opened the "OP Properties", dialog "Display" tab with the "OP"  icon.

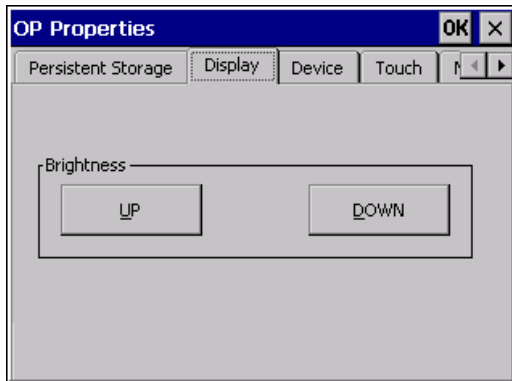

Procedure

Proceed as follows:

1. If you want to increase the brightness, press the "UP" button.
2. If you want to decrease the brightness, press the "DOWN" button.
3. Confirm your entries.

The dialog closes.

Result

The screen settings have been changed.

6.8.5 Setting the screen saver

Introduction

You can set the following time intervals on the HMI device:

- For the automatic activation of the screen saver
- For the automatic reduction in the screen's backlighting

When you do not undertake an operation within the configured interval, the configured function will be activated automatically.

The screen saver and the reduced screen backlighting functions are switched back off by means of the following actions:

- By pressing any key
- By touching the touch screen

The function associated to the key or button will not be executed by this.

NOTICE

Reduce backlighting

The brightness of the backlighting decreases incrementally during its operational life.

In order to not shorten the operational lifetime of the backlighting unnecessarily, activate the backlighting reduction.

Activating the screen saver

Screen contents may occasionally leave a burn-in effect in the background if they appear too long.

This burn-in effect will automatically disappear after a certain amount of time if the screensaver is activated, for example. The longer the same content is displayed on the screen, the longer it will take for the burn-in effect to disappear.

Generally, you should always activate the screen saver.

When the screen saver is active, the backlighting is reduced at the same time.

Requirement

You have opened the "Screensaver" dialog with the "ScreenSaver"  icon.

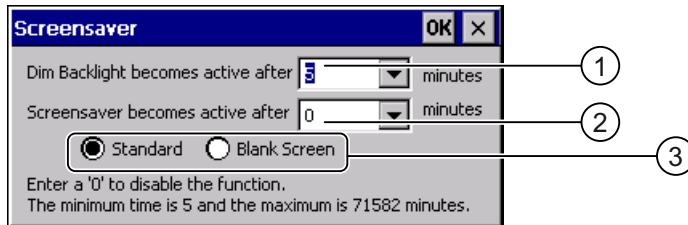

- ① Time interval in minutes until backlighting is reduced
- ② Period of time in minutes before the screen saver is activated
- ③ Radio buttons for the screensaver

Procedure

Proceed as follows:

1. Enter the interval in minutes after which the backlighting is to be reduced.
Entering "0" will deactivate the backlighting reduction.
2. Enter the number of minutes before the screen saver is to be activated.
The minimum time is 5 minutes and the maximum time is 71582 minutes. Entering "0" disables the screen saver.
3. Select either the screen saver or an empty screen.
 - If you want the screen saver to function, activate the "Standard" radio button.
 - If you do not want the screen saver to function, activate the "Blank Screen" radio button.
4. Confirm your entries.
The dialog closes.

Result

The screen saver and the reduced backlighting for the HMI device is set.

6.8.6 Changing the printer properties

Introduction

The HMI device can print on local printers or network printers. You can print hardcopies and reports on a network printer. Line printing of alarms is not possible on a network printer.

You can find the list of current printers and required settings for HMI devices in the Internet at "<http://support.automation.siemens.com/WWW/view/en/11376409>".

Requirement

You have opened the "Printer Properties" dialog with the "Printer"  icon.

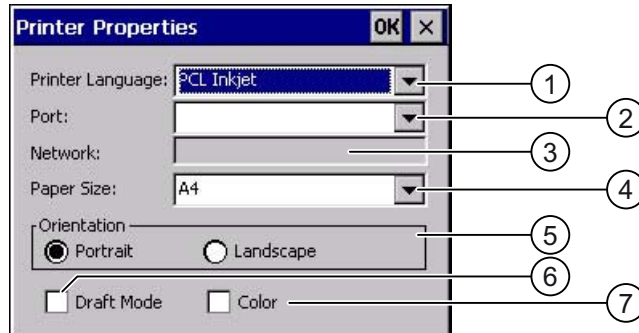

- ① Selection box for the printer
- ② Interface selection box
- ③ Network address of the printer
- ④ Paper format selection box
- ⑤ Group orientation with radio buttons for print orientation
- ⑥ Print quality check box
- ⑦ Color printing check box

Procedure

Proceed as follows:

1. Select a printer from the "Printer Language" selection box.
2. Select the port for the printer from the "Port" selection box.
3. If you wish to print via the network, enter the printer's network address in the "Network" text box.
4. Select the paper format from the "Paper Size" selection box.
5. Activate a radio button in the "Orientation" group.
 - "Portrait" for portrait
 - "Landscape" for landscape
6. Select the print quality.
 - Select the "Draft Mode" check box if you wish to print in draft mode.
 - Clear the "Draft Mode" check box if you wish to print with higher quality.
7. If the printer selected can print in color and you wish it to do so, activate the "Color" check box.
8. Confirm your entries.

The dialog closes.

Result

The settings for the printer have now been changed.

6.8.7 Enabling sound and setting sound volume

Introduction

You can activate an acoustic feedback for keyboard and touch screen operations. With each touch or activation of a key, a sound is emitted.

Requirements

You have opened the "Volume & Sounds Properties" dialog, "Volume" tab with the "Volume & Sounds"  icon.

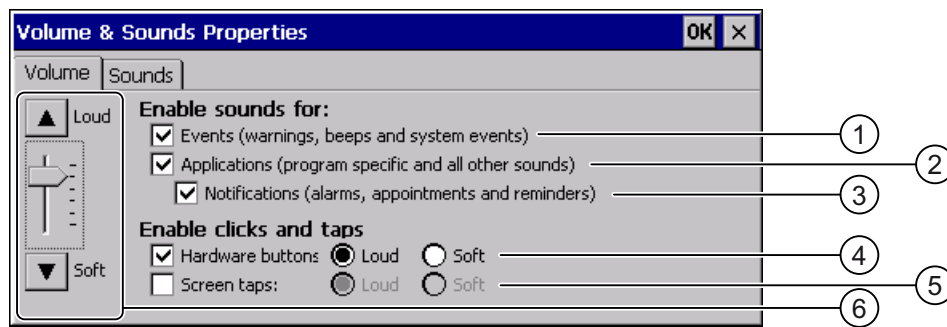

- ① Acoustic warnings and system events
- ② Program-specific sounds
- ③ Notification sounds
- ④ Acoustic feedback when using keys
- ⑤ Acoustic feedback when using touch screen
- ⑥ Keys and controller for setting volume for the "Enable sounds for" group

Note

If you deactivate the settings under "Enable sounds for", no more acoustic signals will be emitted during inadvertent operations.

Procedure

Proceed as follows:

1. Activate the check boxes needed in the "Enable sounds for" group.
If no check boxes are activated, no acoustic feedback will be output.
2. If you want signaling for entries to be audible, activate the following check box:
 - With key control: "Hardware buttons".
 - With touch control: "Screen taps".
3. Use the "Loud" and "Soft" radio buttons to select between loud and quiet signaling.
4. If you want to change the volume for acoustic messages, use the controller or "Loud" and "Soft" keys to do this.
5. Confirm your entries.
The dialog closes.

Result

The properties of the acoustic operation feedback are now set up.

6.8.8 Assigning sound to an event

Introduction

When acoustic feedback is activated, a sound is used to report an event. You can select the sound to reflect the event.

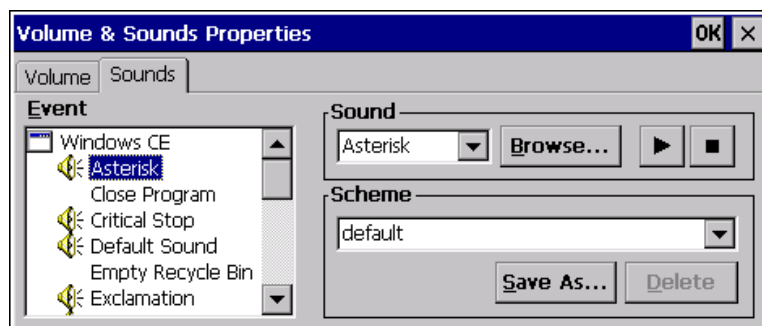

Requirements

- A loudspeaker is connected to the HMI device.
- You have opened the "Volume & Sounds Properties", dialog "Sound" tab with the "Volume & Sounds"  icon.



Procedure

Proceed as follows:

1. Select a suitable sound from the "Event" group.
The sound selected is displayed in the "Sound" group in the associated list box.
2. If you want to listen to the sound, press the "" button.
The sound is output by a loudspeaker connected to the HMI device. Use the  button to stop the output.
3. If you haven't managed to find a suitable sound, you can use the "Browse" button to switch to a folder of your choice.
The sound selected is displayed in the "Sound" group in the associated list box.
4. Confirm your entries.
The dialog closes.

Result

The sound is set for acoustic feedback on operations.

6.8.9 Restarting the HMI device

Introduction

You can restart the HMI device or reset the factory settings before rebooting. Further information on this can be found in the section "Resetting factory settings (Page 174)".

Required restart

The HMI device must be restarted in the following cases:

- You have activated or deactivated the PROFINET IO direct keys.
- You have changed the time zone setting.
- You have changed the automatic daylight savings and standard setting

NOTICE
Data loss when the HMI device is restarted
All volatile data is lost when the HMI device is restarted.
Check the following:
<ul style="list-style-type: none">• The project on the HMI device is complete.• No data is being written to the flash memory.

The HMI device must be restarted in the following cases:

Requirement

- You have opened the "OP Properties" dialog box, "Device" tab, by touching

the "OP"  icon.

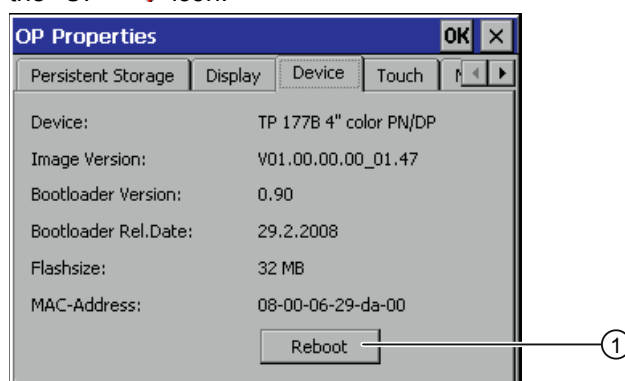

① Button for restarting the HMI device

- If you want to reset the HMI device to the factory settings: the HMI device is connected to a configuration PC via PROFINET.

Procedure

1. If you want to restart the HMI device, press the "Reboot" button.

The following message is displayed:

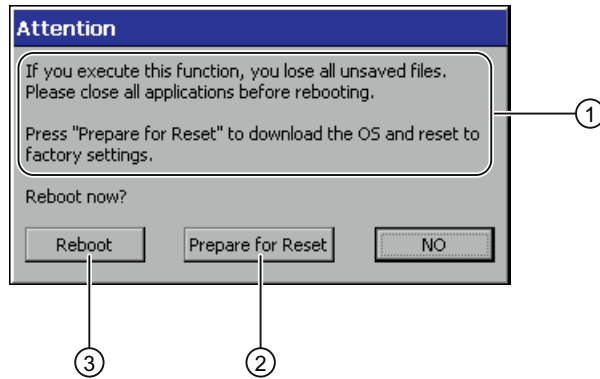

- ① If you run this function, all data which has not been backed up will be lost. Please close all applications before restarting.
 - ② Button for reset to factory settings and subsequent restart
 - ③ Button for restart
2. Press one of the buttons.
 - If you want to restart the HMI device, press the "Reboot" button.
The HMI device restarts without delay.
 - If you want to reset the HMI device to the factory settings and then restart, press the "Prepare for Reset" button.
You are given the option of resetting the HMI device to the factory settings through ProSave. The HMI device then restarts.
 - If you do not want to restart the HMI device, press the "No" button.
The message closes. There will be no restart.

Result

The HMI device starts.

6.8.10 Displaying information about the HMI device

Introduction

You will need the device-specific information if you contact Technical Support.

Requirement

You have opened the "OP Properties" dialog box, "Device" tab, by touching the "OP"  icon.

The following figure applies to the MP 377 15" Touch. The data displayed are device-specific and may therefore deviate from that of your HMI device.

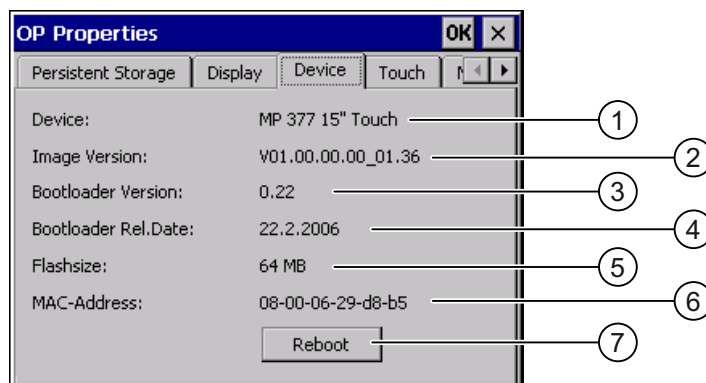

- ① HMI device name
- ② Version of the HMI device image
- ③ Version of the boot loader
- ④ Boot loader release date
- ⑤ Size of the internal flash memory in which the HMI device image and project are stored
- ⑥ MAC address of the HMI device
- ⑦ See section "Restarting HMI device"

The HMI device-specific information is displayed in the "Device" tab.

Note

The size of internal flash memory is not equivalent to application memory available for a project.

See also

Restarting the HMI device (Page 125)

6.8.11 Displaying system properties

Introduction

The general system-specific information provides you with information about the processor, operating system and memory.

Requirements

You have opened the "System Properties", dialog "General" tab with the "System"  icon. The data displayed are device-specific and may therefore deviate from that of your HMI device.

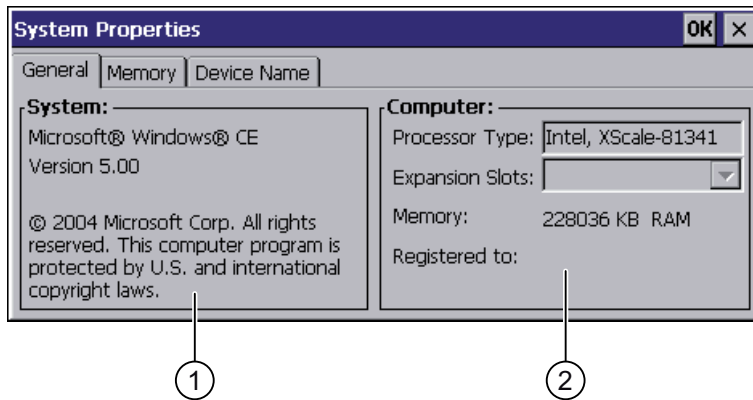

- ① Copyright to Microsoft Windows CE
- ② Details on processor and size of internal Flash memory

Displaying system properties

The system properties are displayed. This dialog is read-only. Close the dialog.

6.8.12 Displaying memory distribution

Introduction

The "Memory" system-specific information provides you with information about the distribution and size of the memory in the HMI device.

NOTICE

"Memory" tab

Do not change the memory distribution in the "Memory" tab.

Applies for the usage of options:

An alteration to the memory distribution may be necessary. Please refer to the accompanying documentation for further information.

Requirements

You have opened the "System Properties", dialog "Memory" tab with the "System"  icon.

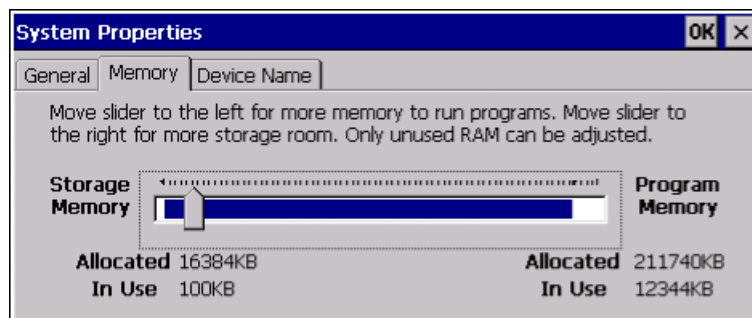

Procedure

1. Determine the HMI device's current memory structure
2. Close the dialog.

6.9 Setting storage location

Introduction

There are various storage locations available for storing the compressed source file of your project. The following describes how you can set the storage location.

Requirements

You have opened the "Transfer Settings", dialog "Directories" tab with the "Transfer"  icon.

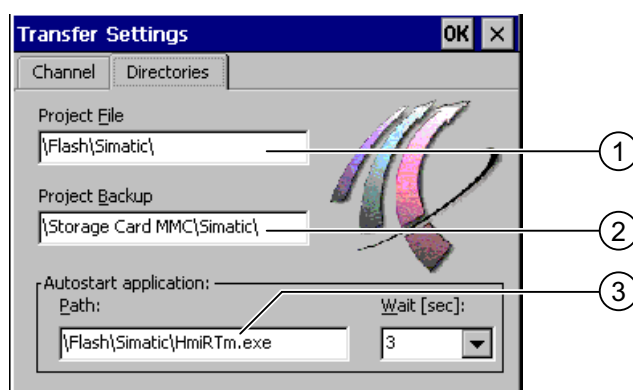

- ① Directory where the project file is saved
- ② Directory where the compressed source file of your project is saved
- ③ Storage location and initialization file of the HMI device for process operation

NOTICE

Settings under "Project File" and "Path"

The project may not open the next time the HMI device is started if changes are made in the "Project File" and "Path" text boxes.

Do not change the entries in the "Project File" and "Path" text boxes.

Procedure

1. Select a memory location from the "Project Backup" text box.
The external memory card or the location in the data network can be defined as the storage location. During the next backup process, the project's source file is stored in the specified location.
2. Confirm your entries.
The dialog closes.

Result

The storage location for the HMI device is now set.

6.10 Setting the delay time

Introduction

Once the HMI device has been switched on, a project can be started after a delay. The Loader is displayed during the delay time.

Requirements

You have opened the "Transfer Settings", dialog "Directories" tab with the "Transfer"  icon.

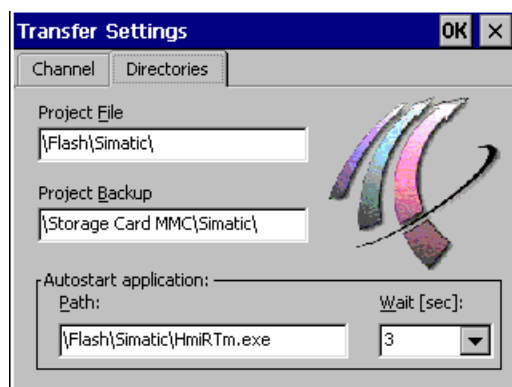

NOTICE

Settings under "Project File" and "Path"

The project may not open the next time the HMI device is started if changes are made in the "Project File" and "Path" text boxes.

Do not change the entries in the "Project File" and "Path" text boxes.

Procedure

1. Select the desired delay time in seconds from the "Wait [sec]" selection box.
With the value "0", the project starts immediately. It is then no longer possible to call the Loader after switching on the HMI device. If you still wish to access the Loader, an operating element must be configured to close the project.
2. Confirm your entries.
The dialog closes.

Result

The delay time for the HMI device is now set.

See also

Overview (Page 163)

6.11 Setting the uninterruptible power supply

Introduction

UPS monitoring is an option you load as an add-on with ProSave.

A UPS ensures that the HMI device is shut down in a controlled manner after a buffer time in the event of a power failure. This avoids the loss of data.

The following uninterruptible power supplies are supported:

SITOP DC UPS modules as of a rated power value of 6 A, e.g. 6EP1931-2DC42

Connect the UPS to the 24-V input and a USB port. Configure the USB port for UPS monitoring.

Requirements

You have opened the "UPS Properties", dialog "Configuration" tab with the "UPS"  icon.

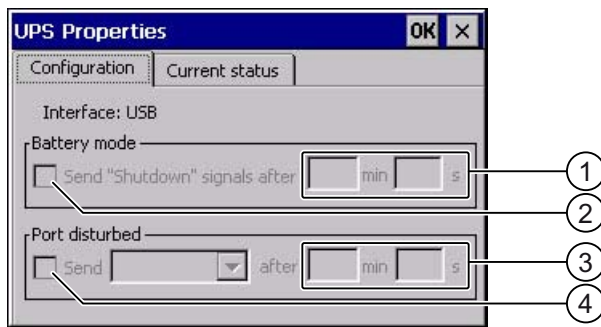

- ① Text box for the time after which the "Battery mode activated" message is displayed
- ② Check box for enabling battery mode
- ③ Text box for the time after which the "Faulty port" message is displayed
- ④ Check box for the "Faulty port" message

Procedure

Proceed as follows:

1. If you want to enable battery mode, activate the "Battery mode" check box.
2. Enter the time for terminating applications in the "min" and "s" text boxes.

You will receive a message when UPS takes effect. Applications such as HMI Runtime and WinAC MP are then terminated depending on the time entered.

3. If the port to which the UPS is connected is faulty and you therefore want to receive a message, activate the "Port disturbed" check box.
4. Select the message you want from the list box.
5. Enter the time after which the "Faulty port" message is displayed in the "min" and "s" text boxes.

Result

Port monitoring for the UPS is set.

See also

State of uninterruptible power supply (Page 133)

6.12 State of uninterruptible power supply

Introduction

If you have connected a UPS to a USB port, you can display the monitoring state of this port.

Requirements

You have opened the "UPS Properties", dialog "Current status" tab with the "UPS"  icon.

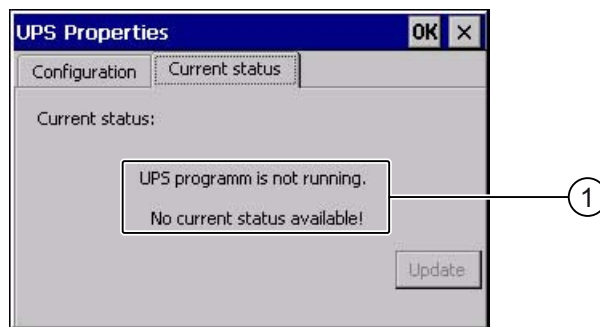

- ① The "UPS program is not running. No current status available." message appears when the UPS is not connected.

Procedure

Proceed as follows:

1. Installing the UPS monitoring software.
2. Connect the UPS.
3. If you want to update the monitoring state, press the "Update" button.

The message is changed according to the current setting. The message will remain unchanged if no check boxes in the "Configuration" tab have been activated.

Result

The current monitoring state for the UPS is displayed.

See also

Setting the uninterruptible power supply (Page 132)

6.13 Enabling PROFINET IO

PROFINET IO

If the HMI device is connected to the PLC via PROFINET, function keys or buttons, for example, can be configured as PROFINET IO direct keys. If PROFINET IO direct keys are used in the project, they must be enabled.

Note

If you enable PROFINET IO direct keys, you cannot use the RS 422/RS 485 port for serial communication.

PROFINET IO direct keys and PROFIBUS DP direct keys are mutually exclusive.

Requirements

You have opened the "PROFINET" dialog with the "PROFINET"  icon.

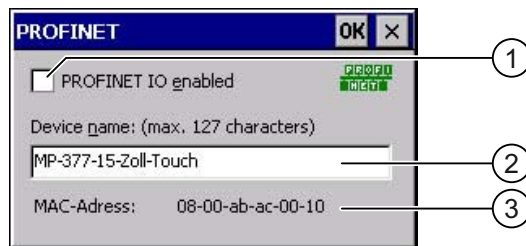

- ① Activating or deactivating the PROFINET IO direct keys
- ② Text box for the device name
- ③ MAC address of the HMI device

NOTICE

Inconsistent device name

If the device name does not match the device name entered in the HW Config of STEP 7, the direct keys do not work.

Use the device name from the HW Config of STEP 7. This device name does not correspond to the device name used under Windows CE.

Within the ETHERNET data network, the device name must be unique and satisfy the DNS conventions. These include:

- Restriction to 127 characters in total (letters, digits, hyphen or point)
- A name component within the device name, e.g. a string between two points, may not exceed 63 characters.
- Special characters such as umlauts, brackets, underscores, slashes, spaces etc. are not permitted. The hyphen is the one exception.
- The device name must not start or end with a the "-" character.
- The device name must not take the form n.n.n.n (n = 0 to 999).
- The device name must not start with the character sequence "port-xyz-" (x, y, z = 0 to 9).

Procedure

Proceed as follows:

1. If you want to enable the PROFINET IO direct keys, activate the "PROFINET IO enabled" check box.
2. Enter the device name of the HMI device.
3. Confirm your entries.

The dialog closes.

Result

The PROFINET IO direct keys are enabled.

6.14 Changing transfer settings

6.14.1 Configuring the data channel

Introduction

If you block all data channels, the HMI device is protected against unintentional overwriting of the project data and HMI device image.

Note

A project can only be transferred from the configuring PC to the HMI device when at least one of the data channels is enabled on the HMI device.

Requirements

The "Transfer Settings" dialog, "Channel" tab has been opened with the "Transfer Settings"  icon.

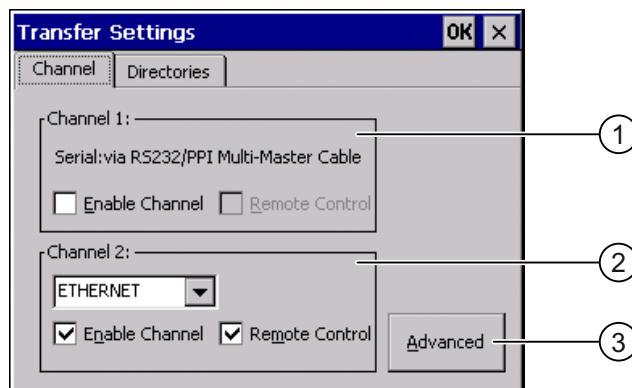

- ① Group for the data channel 1 (Channel 1)
- ② Group for the data channel 2 (Channel 2)
- ③ Button for the "MPI/DP-Transfer Settings" and/or "Network and Dial-Up Connections" dialog

WARNING

Unintentional transfer mode

Unintentional transfer mode could cause unintentional actions to be triggered in the plant. Ensure that the configuring PC does not inadvertently switch the HMI device to transfer mode during the open project.

NOTICE

"Remote control" for "Channel 1"

If the "Remote Control" check box is activated during "Online" operating mode, the X10 port cannot be used for communication.

The "Remote Control" check box must be deactivated for "Online" operating mode. Once the serial transfer is complete, in the "Channel 1" group you must therefore deactivate the "Remote Control" check box.

Transfer mode using "Channel 2"

When the project on the HMI device starts, transfer parameters, e.g. HMI device address, for MPI/PROFIBUS DP are overwritten with the values from the project.

You can change the settings for the transfer via "Channel 2".

The following steps are required:

- Close the project.
- Change the settings on the HMI device.
- Then return to "Transfer" mode.

The next time the project is started on the HMI device, the settings will be overwritten by the values from the project.

Note

If the HMI device is in "Transfer" mode while changes are made to the transfer settings, the settings only go into effect after the transfer function is restarted.

This may occur if the Control Panel is opened to change the transfer properties in an active project.

Procedure

Proceed as follows:

1. If you want to enable a data channel, activate the "Enable Channel" check box in the "Channel 1" or "Channel 2" group.

In the "Channel 1" group, the RS-422/RS-485 port is enabled for the serial data transfer. The network port is enabled in the "Channel 2" group.
2. If you want to enable the automatic transfer, activate the associated "Remote Control" check box.
3. If you have enabled the data channel for "Channel 2", select the log from the selection box.
4. Enter further parameters if required.

Applies to "MPI/PROFIBUS DP":
 - Press the "Advanced" button to switch to the "S7-Transfer Settings" dialog box. You can change the settings for MPI/PROFIBUS DP there.
 - Confirm your entries.
 - The "S7-Transfer Settings" dialog box closes.Applies to "ETHERNET":
 - Use the "Advanced" button to change to "Network&Dial-Up Connections".
 - Open the "ERTEC400" entry. You can change the TCP/IP settings there.
 - Confirm your entries.
 - Close "Network&Dial-Up Connections".Applies to "USB":
 - No settings are needed for "USB".
5. Confirm your entries.

The dialog closes.

Result

The data channel is configured.

See also

- Overview (Page 163)
- Backup and restore using WinCC flexible (Page 169)
- Backup and restore using ProSave (Page 171)
- Changing MPI/PROFIBUS DP settings (Page 139)
- Changing the network configuration (Page 145)

6.14.2 Changing MPI/PROFIBUS DP settings

Introduction

The communication settings for MPI or PROFIBUS DP are defined in the HMI device project. In the following cases, the transfer settings might have to be changed:

- The first time the project is transferred
- If changes are made to the project but are only applied later

<p>NOTICE</p> <p>Transfer mode using MPI/PROFIBUS DP</p> <p>The bus parameters are read from the project currently loaded on the HMI device. The settings for MPI/PROFIBUS DP transfer can be modified. The following steps are required:</p> <ul style="list-style-type: none">• Close the project.• Change the settings on the HMI device.• Then return to "Transfer" mode. <p>The changed MP/PROFIBUS DP settings will be overwritten in the following cases:</p> <ul style="list-style-type: none">• The project is started again• A project is transferred and started <p>Transfer settings</p> <p>If the HMI device is in "Transfer" mode while changes are made to the transfer settings, the settings only go into effect after the transfer function is restarted.</p>

Requirements

You have opened the "S7-Transfer Settings" dialog with the "S7-Transfer Settings"  icon.

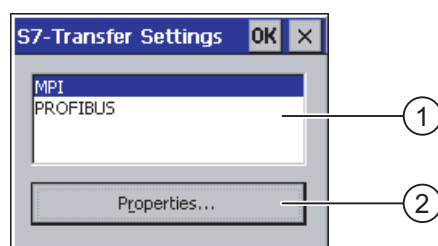

- ① Network selection
- ② Button for opening the properties dialog

Procedure

Proceed as follows:

1. Select a network.
2. Use the "Properties" button to open the "MPI" or "PROFIBUS" dialog.

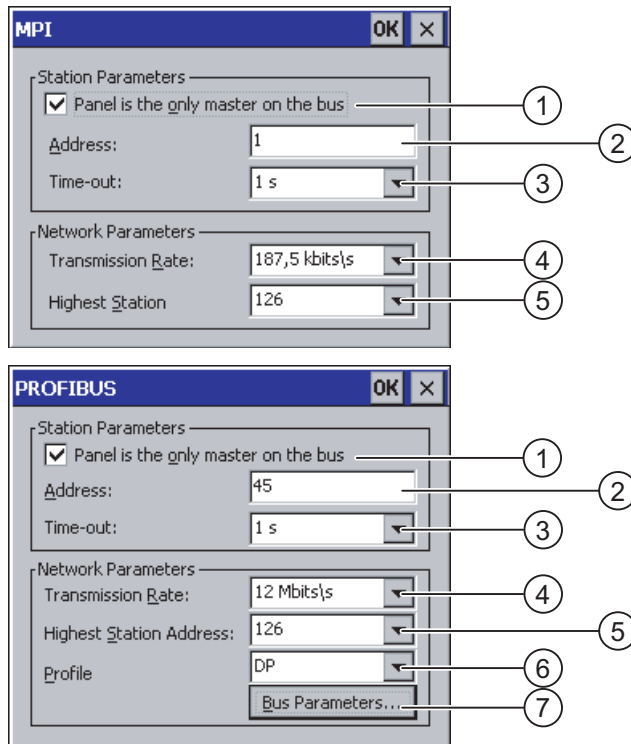

- ① The HMI device is the only master on the bus.
- ② Bus address of the HMI device
- ③ Time-out
- ④ Data transmission rate in total network
- ⑤ Highest station address in the network
- ⑥ Profile
- ⑦ Button for displaying the bus parameters

3. If there are several masters connected on the bus, deactivate the "Panel is the only master on the bus" check box.
4. Enter the bus address for the HMI device in the "Address" text box.

NOTICE

The bus address in the "Address" text box must be unique throughout the MPI/PROFIBUS DP network.

5. Select the transmission rate from the "Transmission Rate" text box.
6. Enter the highest station address on the bus in the "Highest Station Address" or "Highest Station" text box.
7. Select the desired profile from the "Profile" selection box.

8. If you want to view the profile data, press the "Busparameter" button of the PROFIBUS dialog.

The profile data are displayed. The "Profile" dialog is read-only.

NOTICE
The bus parameters must be the same for all stations in the MPI/PROFIBUS DP network.

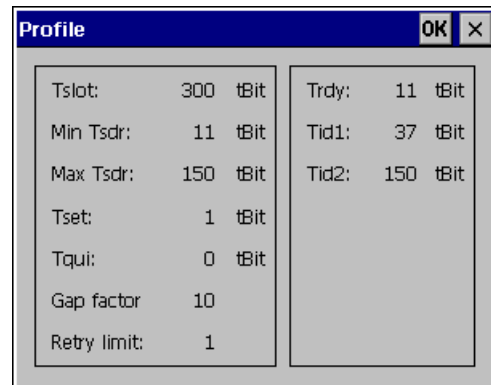

9. Close the "Profile" dialog.
10. Confirm your entries.

The dialog closes.

Result

The MPI/PROFIBUS DP settings of the HMI device have been changed.

See also

Configuring the data channel (Page 136)

6.15 Configuring network operation

6.15.1 Overview of network operation

Introduction

You can connect the HMI device to a PROFINET network via the Ethernet port.

NOTICE
The HMI device only has client functionality in the PC network. This means that users can access files of a node with TCP/IP server functionality from the HMI device via the network. However, you cannot, for example, access files of the HMI device from a PC via the network.

Note

Information on communication using SIMATIC S7 via PROFINET is provided in the "WinCC flexible communication" user manual.

The connection to a network offers, for example, the following options:

- Printing via a network printer
- Saving, exporting and importing of recipe data records on or from a server
- Setting up of message and data archives
- Transferring a project
- Saving data

Addressing

Within a PROFINET network, computers are usually addressed using computer names. These device names are translated from a DNS or WINS server to TCP/IP addresses. This is why a DNS or WINS server is needed for addressing via computer names when the HMI device is in a PROFINET network.

The corresponding servers are generally available in PROFINET networks.

Note

The use of TCP/IP addresses to address PCs is not supported by the operating system.

Consult your network administrator if you have questions in this regard.

Printing via a network printer

The HMI device's operating system does not support line by line alarm logging via a network printer. All other printing functions, for example, hardcopy or logs, are available without restriction via the network.

Preparation

Before beginning the configuration, request the following network parameters from your network administrator.

- Does the network use DHCP for dynamic assignment of network addresses?
If not, get a new TCP/IP network address for the HMI device.
- Which TCP/IP address does the default gateway have?
- If a DNS network is used, what are the addresses of the name server?
- If a WINS network is used, what are the addresses of the name server?

General procedure for configuring the network

The HMI device must be configured prior to network operation. The configuration is basically divided into the following steps:

Proceed as follows:

1. Enter the device name of the HMI device.
2. Configure the network address.
3. Set the logon information.
4. Save the settings.

6.15.2 Setting the device name of the HMI device

Introduction

The HMI device uses the device name to identify itself in the communication network.

Requirements

You have opened the "System Properties", dialog "Device Name" tab with the "System"  icon.

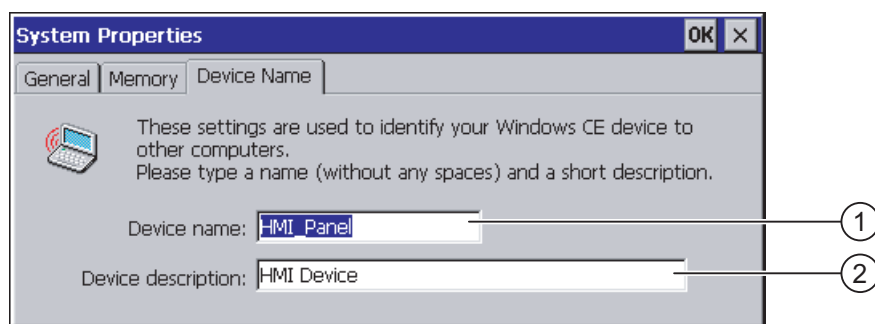

- ① Device name of the HMI device
- ② Description for the HMI device (optional)

Note

To activate the network functions, enter a unique computer name in the "Device name" text box.

Procedure

Proceed as follows:

1. Enter the device name for the HMI device in the "Device name" text box.
2. If necessary, enter a description for the HMI device in the "Device description" text box.
3. Confirm your entries.

The dialog closes.

Result

The device name for the HMI device is now set.

6.15.3 Changing the network configuration

Introduction

You can change the network settings for the LAN connection under "Network&Dial-Up Connections".

Requirements

You have opened the following display using the "Network&Dial-Up Connections"  icon.



Procedure

Proceed as follows:

1. Open the "ERTEC400" entry.

The "'ERTEC400 Ethernet Driver' Settings" dialog is opened.

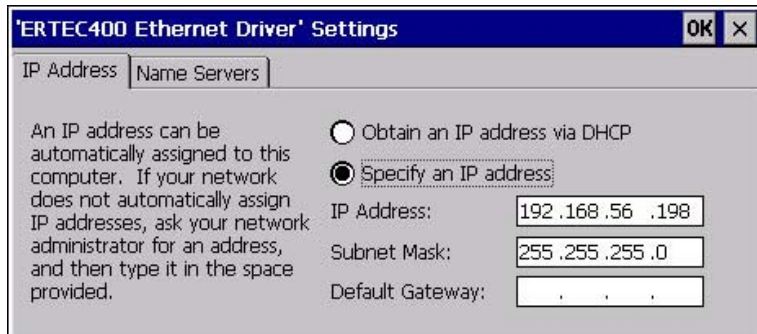

2. If you need automatic issuing of addresses, select the "Obtain an IP address via DHCP" radio button.
3. If you need manual issuing of addresses, select the "Specify an IP address" radio button.
4. If you have selected manual issuing of addresses, enter the corresponding addresses in the "IP Address", "Subnet Mask" text boxes and if necessary in "Default Gateway".
5. If a name server is used in the network, change to the "Name Servers" tab.

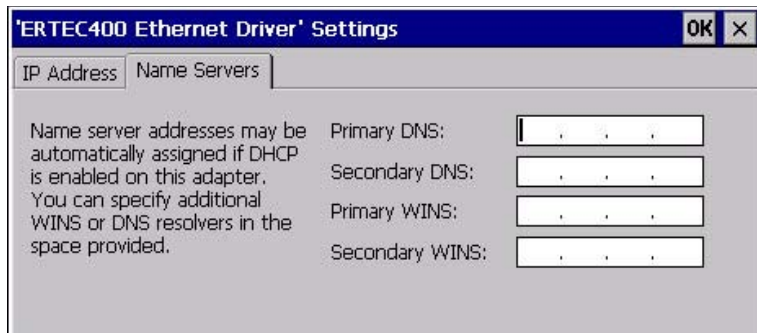

6. Enter the respective addresses in the text boxes.
7. Confirm your entries.
The dialog closes.
8. Close the "Network&Dial-Up Connections" display.
The Control Panel is displayed again.

Result

The LAN connection parameters for the HMI device have been changed.

See also

Configuring the data channel (Page 136)

6.15.4 Changing the logon data

Introduction

Windows CE uses this information to gain access to the network resources. Enter the user name, password and domain you have received from your administrator.

Requirements

You have opened the "Network ID" dialog with the "Network ID"  icon.

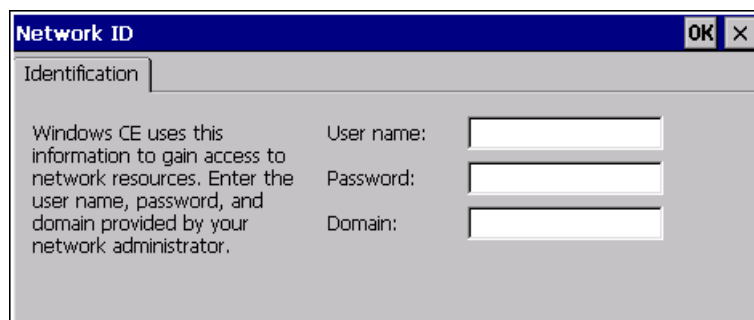

Procedure

Proceed as follows:

1. Enter the user name in the "User name" text box.
2. Enter your password in the "Password" text box.
3. Enter the domain name in the "Domain" text box.
4. Confirm your entries.

The dialog closes.

Result

The logon information has now been set.

6.15.5 Changing e-mail settings

Requirements

You have opened the "WinCC flexible Internet Settings" dialog with the "WinCC Internet Settings"  icon.

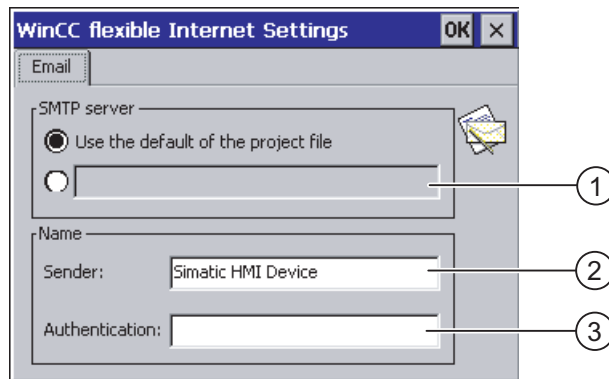

- ① Setting the SMTP server
- ② Name for the sender
- ③ E-mail account

Note

Additional tabs may appear in the "WinCC flexible Internet Settings" dialog. This depends on the options that have been enabled for network operation in the project.

Procedure

Proceed as follows:

1. Specify the SMTP server.
 - Activate the "Use the default of the project file" radio button if you want to use the SMTP server configured in the project.
 - Deactivate the "Use the default of the project file" radio button if you do not want to use the SMTP server configured in the project. Specify the required SMTP server.
2. Enter the name for the sender in the "Sender" text box.
3. Enter the e-mail account for your e-mail in the "Authentication" text box.

Some e-mail providers only allow you to send mail if you specify the e-mail account. The "Authentication" text box can remain empty if your e-mail provider allows you to send mail without checking the account.

4. Confirm your entries.

The dialog closes.

Result

The e-mail settings have been changed.

6.15.6 Changing Internet settings

6.15.6.1 Changing general Internet settings

Requirements

You have opened the "Internet Options", dialog "General" tab with the "Internet Options"  icon.

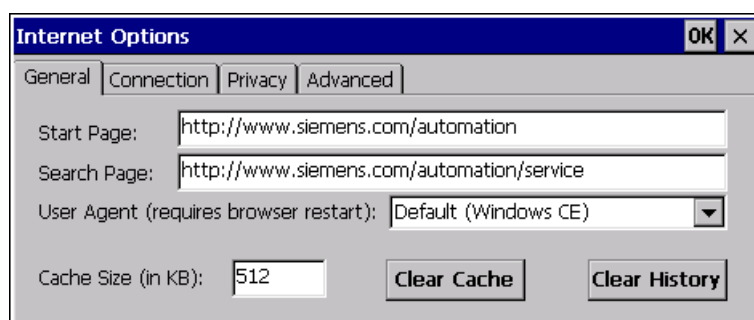

Note

Do not change the settings in the "User Agent" field.

Procedure

Proceed as follows:

1. Enter the homepage for the Internet browser in the "Start Page" text box.
2. Enter the address of the required search engine in the "Search Page" text box.
3. Enter the required cache memory size in the "Cache" text box.
4. If you want to delete the cache memory, press the "Clear Cache" button.
5. If you want to delete the history, press the "Clear History" button.
6. Confirm your entries.

The dialog closes.

Result

The general parameters for the Internet browser have been set.

6.15.6.2 Setting the proxy server

Requirements

You have opened the "Internet Options", dialog "Connection" tab with the "Internet Options"  icon.



Procedure

Proceed as follows:

1. Select the "Use LAN (no autodial)" check box.
2. If you are using a proxy server, in the "Network" group, activate the "Access the Internet using a proxy server" check box.
Specify the address of the proxy server and the port.
3. If you want to bypass the proxy server for local addresses, activate the "Bypass proxy server for local addresses" check box.

4. Confirm your entries.

The dialog closes.

6.15.6.3 Changing privacy settings

Cookies and encryption

Cookies are pieces of information sent by a web server to a browser. In the event of subsequent access to the web server, the cookies are sent back. This enables information to be stored between the accesses.

In order to ensure a high level of privacy, data are sent via the Internet in encrypted form. Common encryption protocols include SSL and TLS. You can activate or deactivate the usage of encryption protocols.

The required settings can be obtained from your network administrator.

Requirements

You have opened the "Internet Options" dialog, "Privacy" tab with the "Internet Options"  icon.



Procedure

Proceed as follows:

1. Select the required cookie behavior by means of the radio buttons.
 - "Accept"
Cookies are stored without request.
 - "Block"
Cookies will not be stored.
 - "Prompt"
Cookies will be stored on request.
2. If you want allow cookies which are restricted to a single session, activate the "Always allow session cookies" check box.
3. Change to the "Advanced" tab.

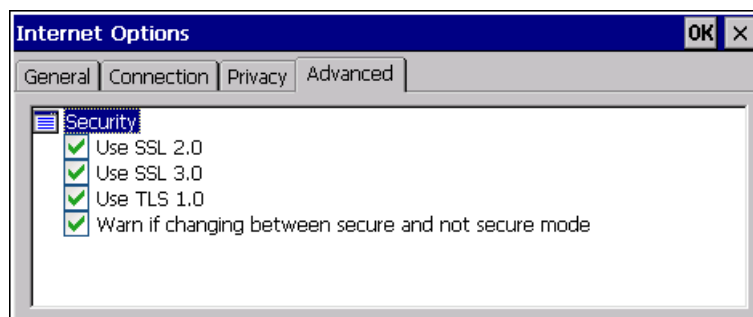

4. Activate the required encryption protocol.
5. Confirm your entries.
The dialog closes.

Result

The logon information has now been set.

6.15.6.4 Importing and deleting certificates

Overview

You can import, view and delete certificates that have been imported for the HMI device. The certificates differ in the following ways:

- Certificates that you trust
- Own certificates
- Other certificates

You can import additional certificates and delete certificates that are not required.

The required settings can be obtained from your network administrator.

Requirements

You have opened the "Certificates" dialog with the "Certificates"  icon.



Procedure

Proceed as follows:

1. Select the type of certificate from the selection box:
 - "Trusted Authorities"
 - "My Certificates"
 - "Other Certificates"
2. If required, start the importing process with the "Import" button.
A dialog with source details will open.
3. If required, delete certificates with the "Remove" button.
Mark the desired certificate.
4. If you want to list the properties of the certificate marked, press the "View" button.
5. Confirm your entries.
The dialog closes.

Result

The changes to the certificates have been undertaken.

6.16 Saving to external storage device (backup)

Introduction

A backup involves copying the operating system, applications and data from the internal in flash memory of the HMI device to an external storage device.

The following external storage devices are possible:

- External memory
- USB memory stick

Requirements

- The HMI device features an external storage device with sufficient free space.
- You have opened the "Backup/Restore" dialog with the "Backup/Restore"  icon.



Procedure - using a memory card for the first time

NOTICE

Loss of data possible

The first time you use a memory card the HMI device will request that you format the card. Save a backup copy of memory card data to a PC before formatting.

Proceed as follows:

1. Cancel the formatting procedure by pressing "ESC".
2. Remove the memory card from the HMI device.
3. Save a backup copy of vital data to a PC.
4. Insert the memory card into the HMI device.
5. Format the memory card on the HMI device.

Procedure

Proceed as follows:

1. Press the "BACKUP" button to open the "Select Storage Card" dialog.

The "--- no storage card available ---" message appears if there is no external memory in the HMI device or if this memory is defective. Insert an external memory or a different one.

2. Select the external memory for backup from the "Please select a Storage Card" list box.
3. Click on the "Start Backup" button.

The HMI device checks the external memory.

If the "This storage card..." message appears, an external memory with a greater memory capacity is needed. Acknowledge this message. Backup is aborted. Insert an external memory with a greater memory capacity and restart the backup process.

If the "You may have an old backup on the storage card. Do you want to delete it?" message appears, there is already a backup on the external memory. If you do not want to overwrite the backup, press the "No" button. Otherwise click on the "Yes" button.

Several messages are displayed in sequence during the backup process:

- Saving registry data
- Copy files

A progress bar shows the status of the backup process. When the backup process is completed, the following message is displayed:

"The operation completed successfully."

4. Acknowledge this message.

The dialog closes.

Result

The HMI device data is now saved on the external memory.

6.17 Restoring from external storage device

Introduction

A restore operation deletes the old data from flash memory of the HMI device on confirmation. The data stored on the external memory is then copied to the internal flash memory.

Requirements

- The external memory holding the backed up data is inserted in the HMI device.
- You have opened the "Backup/Restore" dialog with the "Backup/Restore"  icon.

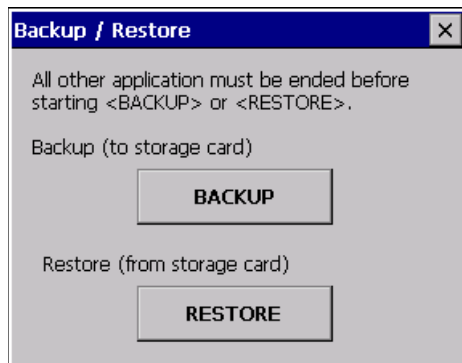

NOTICE

Loss of data possible

All data on the HMI device will be deleted during a restore operation. License keys are deleted after counter-inquiry.

Back up the HMI device's data before restoring if required.

External memory with data backup

If several external memories with data backups are plugged in, the data cannot be restored.

Remove the external memory with the data backups not needed.

Procedure

Proceed as follows:

1. Press the "RESTORE" button to open the "Storage Card" dialog.



- ① No storage card available
 - ② Only one storage card containing backup is allowed. No storage card detected. Insert a storage card and press the "Refresh" button.
2. Select the external memory with the backup from the "Storage Card with Backup detected" selection box.
The "--- no storage card available ---" message appears if there is no external memory in the HMI device or if this memory is defective.
3. If the "--- no storage card available ---" message appears, press the "Cancel" button.
Restoring is then aborted.
 - Insert a memory card or a different one.
 - Click on the "Refresh" button.
The content of the selection box will be changed.
 - Select the external memory with the backup from the "Storage Card with Backup detected" selection box.
4. Click on the "Start Restore" button.
Restoring is started.

5. The data to be restored is checked.

The following messages are displayed in sequence during the check.

- "Starting Restore"
- "Checking data"

When the data has been checked, the following message is displayed:

"You are starting RESTORE now. All files (except files on storage cards) and the registry will be erased. Are you sure?"

The message means that the restore process can be started. All files except those located on the external memory will be deleted. Tab entries are also deleted. Are you sure?

6. If you do not want to allow the data to be deleted from the HMI device, abort the restore process by pressing the "ESC" button.
7. Start to restore the data by selecting "Yes".

The following messages are displayed in sequence during the restore:

- "Deleting files on flash"
- "Restore CE Image"

A progress bar shows the status of the restore process.

When restore is completed, the following message is displayed:

"Restore successfully finished. Press ok, remove your storage card and reboot your device."

8. Remove the external memory.
9. Acknowledge this message.

The HMI device starts.

Result

The data from the external memory is now on the HMI device.

Note

Calibrating the touch screen

After the reset, you may have to recalibrate the touch screen.

6.18 Activate memory management

Memory management

Provided the memory management is activated, the HMI device will automatically close the project if the memory needs reorganizing during an active project.

The project is shut down and the HMI device will display a message. You have to restart the project.

NOTICE
Memory management
If you do not activate memory management, undefined states can occur during the runtime of the project.
Active memory management from the "OP Properties" dialog.

Requirements

You have opened the "OP Properties" dialog, "Memory Monitoring" tab with the "OP"  icon.

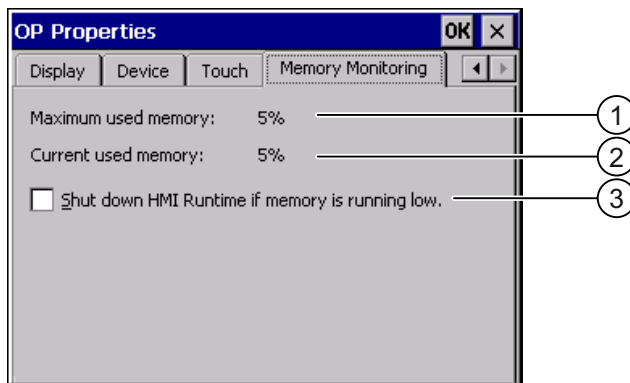

- ① Maximum memory used since the HMI device was last switched on
- ② Percentage of memory currently used
- ③ Activate memory management

Procedure

Proceed as follows:

1. If you want to enable memory management, activate the check box.
If memory management is active and there is not enough working memory, the SIMATIC HMI runtime and therefore the current project will be closed.
2. Confirm your entries.
The dialog closes.

Result

Memory management is activated.

Commissioning a project

7.1 Overview

Configuration phase

A project – the process image of the working process – is produced during configuration to visualize automated working processes. The process displays for the project contain displays for values and messages which provide information about process statuses. The process control phase follows the configuration phase.

Process control phase

The project must be transferred to the HMI device if it is to be used in process control. Another precondition for process control is that the HMI device is connected online to a controller. Current working processes - operating and observing - can then be subject to process control.

Transferring the project to the HMI device

You can transfer a project to an HMI device as follows:

- Transfer from the configuring PC
- Restore from a PC using ProSave

In this case, an archived project is transferred from a PC to the HMI device. The configuration software need not be installed on this PC.

Commissioning and recommissioning

Initial and re-start-ups differ in the following respects:

- When the HMI device is commissioned there is no project at first.
The HMI device is also in this state after the operating system has been updated.
- When recommissioning, any project already on the HMI device is replaced.

7.2 Operating modes

Operating modes

The HMI device may be in the following operating modes:

- Offline
- Online
- Transfer

"Offline mode" and "Online mode" can be set on both the configuring PC and the HMI device. To set these modes on the HMI device, use a corresponding operating element of the project.

Changing the operating mode

The configuration engineer must have configured an appropriate operating element to allow a change of the operating mode on the HMI device during ongoing operation.

Further information on this may be available in your plant documentation

"Offline" operating mode

In this mode, there is no communication between the HMI device and PLC. Although the HMI device can be operated, it cannot exchange data with the PLC.

"Online" operating mode

In this mode, the HMI device and PLC communicate. You can operate the plant on the HMI device according to your system configuration.

"Transfer" mode

In this mode, you can transfer a project from the configuring PC to the HMI device or backup and restore HMI device data, for example.

The following options are available for setting "Transfer" mode on the HMI device:

- When the HMI device starts up

Start "Transfer" mode manually in the HMI device Loader.

- During ongoing operation

Start the "Transfer" mode manually within the project using an operating element. The HMI device toggles to "Transfer" mode when automatic mode is set and a transfer is initiated on the configuring PC.

See also

Backup and restore using WinCC flexible (Page 169)

Backup and restore using ProSave (Page 171)

7.3 Using existing projects

The following table shows how you can reuse existing projects, while observing the screen size:

HMI device in the existing project	New HMI device
MP 370 12" Touch	MP 377 12" Touch
MP 370 12" Key	MP 377 12" Key
MP 370 15" Touch	MP 377 15" Touch, MP 377 PRO 15" Touch

The following cases are possible:

1. Project exists in ProTool
Migrate the project to WinCC flexible and then replace the HMI device.
2. Project exists in WinCC flexible
Carry out an HMI device switch in WinCC flexible.

If you migrate existing projects from HMI devices with a different screen size, images which have already been configured are converted during the migration.

Further information on the subject can be found in the WinCC flexible Online Help or in the "WinCC flexible Migration" manual.

7.4 Data transmission options

Overview

The following table shows the options for data transfer between the MP 377 and the configuring PC.

Type	Data channel	MP 377
Backup	Serial ¹⁾	Yes
	MPI/PROFIBUS DP	Yes
	USB	Yes
	PROFINET	Yes
Restoring	Serial ¹⁾	Yes
	MPI/PROFIBUS DP	Yes
	USB	Yes
	PROFINET	Yes
Updating the operating system	Serial ¹⁾	Yes
	MPI/PROFIBUS DP	Yes
	USB	Yes
	PROFINET	Yes
	PROFINET with restore to factory setting	Yes
Transferring a project	Serial ¹⁾	Yes
	MPI/PROFIBUS DP	Yes
	USB ²⁾	Yes
	PROFINET	Yes
Installing or removing an option	Serial ¹⁾	Yes
	MPI/PROFIBUS DP	Yes
	USB	Yes
	PROFINET	Yes
License key transferring or transferring back	Serial ¹⁾	Yes
	MPI/PROFIBUS DP	Yes
	USB	Yes
	PROFINET	Yes

¹⁾ Applies when PC/PPI cable 6ES7 901-3CB30-0XA0 is used

²⁾ You must not connect the HMI device to a USB 2.0 hub.

See also

Overview (Page 163)

Backup and restore using WinCC flexible (Page 169)

Backup and restore using ProSave (Page 171)

7.5 Transfer

7.5.1 Overview

Transfer

Transfer the executable project from the configuring PC to the HMI device.

You can start the "Transfer" mode manually or automatically on the HMI device.

Transferred data is written directly to the internal flash memory on the HMI device. For the transfer, you use a data channel which you have to configure before starting a transfer.

Backtransfer

You have the option to transfer the compressed project file together with the runtime project to the HMI device. If necessary, the compressed project file can be transferred back to the configuring PC and edited.

The HMI device must be equipped with an external memory card to which the compressed project file can be saved.

NOTICE
Compressed project file
WinCC flexible does not check whether the compressed project file stored on the HMI device corresponds to the existing runtime project.

See also

Setting the delay time (Page 131)

Configuring the data channel (Page 136)

Data transmission options (Page 162)

7.5.2 Starting manual transfer

Introduction

You can manually switch the HMI device to "Transfer" mode as follows:

- With a configured operating element during ongoing operation.
- In the Loader of the HMI device.

Requirements

- The project "*.hmi" is opened in WinCC flexible.
- The HMI device is connected to a configuring PC.
- The data channel is configured on the HMI device.
- The HMI device is in "Transfer" mode.

Procedure

Proceed as follows:

1. On the configuring PC, select the "Transfer settings" command in the menu "Project > Transfer" in WinCC flexible.

The "Select devices for transfer" dialog opens.

2. Select the HMI device in the left area of the dialog.
3. Select the type of connection between the HMI device and the configuring PC.

Set the connection parameters.

4. Set the transfer parameters in the right area of the dialog.

5. If you wish to transfer the compressed project file together with the runtime project to the HMI device:

Select the "Enable backtransfer" check box.

6. Start transfer in WinCC flexible with "Transfer".

The configuring PC checks the connection to the HMI device. The project is transferred to the HMI device. If the connection is not available or is defective, an error message is displayed on the configuring PC.

Result

When the transfer is completed successfully, the project can be found on the HMI device. The transferred project is then started automatically.

7.5.3 Starting automatic transfer

Introduction

If automatic transfer is activated, the HMI device automatically changes into "Transfer" mode during operations as soon as a transfer starts on the configuring PC connected.

Note

With automatic transfer, the HMI device only changes into "Transfer" mode when the project is running on the HMI device.

Automatic transfer is particularly suited for the test phase of a new project since transfer is completed without interfering with the HMI device.

NOTICE

If the automatic transfer has been activated on the HMI device and a transfer is initiated on the configuring PC, the project currently running is automatically stopped. The HMI device then automatically switches to "Transfer" mode.

After the commissioning phase, deactivate the automatic transfer so that the HMI device cannot be inadvertently switched to transfer mode. The transfer mode can trigger unintentional actions in the device.

You can issue a password in the control panel to restrict access to the transfer settings and thus avoid unauthorized modifications.

Requirements

- The project *.hmi is opened in WinCC flexible.
- The HMI device is connected to a configuring PC.
- The data channel is configured on the HMI device.
- The automatic transfer is activated in the data channel for the transfer.
- The project is started on the HMI device.

Procedure

Proceed as follows:

1. On the configuring PC, select the "Transfer settings" command in the menu "Project > Transfer" in WinCC flexible.
The "Select devices for transfer" dialog opens.
2. Select the HMI device in the left area of the dialog.
3. Select the type of connection between the HMI device and the configuring PC.
Set the connection parameters.
4. Set the transfer parameters in the right area of the dialog.
5. If you wish to transfer the compressed project file together with the runtime project to the HMI device:
Select the "Enable backtransfer" check box.
6. Start transfer in WinCC flexible with "Transfer".
The configuring PC checks the connection to the HMI device. The HMI device shuts down the current project and automatically switches to "Transfer" mode. The project is transferred to the HMI device. If the connection is not available or is defective, an error message is displayed on the configuring PC.

Result

When the transfer is completed successfully, the project can be found on the HMI device. The transferred project is then started automatically.

7.5.4 Starting backtransfer

Requirements

- No project is open in WinCC flexible.
- The HMI device is connected to a configuring PC.
- The data channel is configured on the HMI device.
- The HMI device is in "Transfer" mode.
- The memory card containing the compressed project file is inserted into the HMI device.

Procedure

Proceed as follows:

1. On the configuring PC, select the "Communication settings" command in the menu "Project > Transfer" in WinCC flexible.

The "Communication Settings" dialog opens.

2. Select the type of HMI device.
3. Select the type of connection between the HMI device and the configuring PC.

Set the connection parameters.

4. Close the dialog with "OK".
5. Select the "Transfer" > "Backtransfer" command in the "Project" menu.

The "Backtransfer" dialog opens.

6. Click "OK" to start the backtransfer process.

The configuring PC checks the connection to the HMI device. The compressed project file is transferred back from the HMI device to the configuring PC. If the connection is not available or is defective, an error message is displayed on the configuring PC.

Result

After successful backtransfer, the project is opened on the configuring PC in WinCC flexible.

7.5.5 Testing a project

Introduction

There are two options to test a project:

- Test the project on the configuring PC

You can test a project at a configuring PC, using a simulator. For detailed information, refer to the "WinCC flexible" user manual and to the WinCC flexible Online Help.

- Offline testing of the project on the HMI device

Offline testing means that communication between the HMI device and PLC is down while the test is being carried out.

- Online testing of the project on the HMI device

Online testing means that the HMI device and PLC communicate with each other during testing.

Perform the tests, starting with the "Offline test", followed by the "Online test".

Note

You should always test the project on the HMI device on which the project will be used.

Check the following:

1. Check the correct layout of the screens
2. Check the screen navigation
3. Check the input objects
4. Enter the tag values

The test increases the certainty that the project will run error-free on the HMI device.

Requirements for offline testing

- The project has been transferred to the HMI device.
- The HMI device is in "Offline" mode.

Procedure

In "Offline" mode, you can test individual project functions on the HMI device without them being affected by the PLC. PLC tags, therefore, are not updated.

Test the operating elements and visualization of the project as far as possible without connecting to the PLC.

Requirements for online testing

- The project has been transferred to the HMI device.
- The HMI device is in "Online" mode.

Procedure

In "Online" mode, you can test individual project functions on the HMI device without them being affected by the PLC. PLC tags are updated in this case.

You have the option to test all communication-dependent functions, for example alarms, etc.

Test the operating elements and views of the project.

7.6 Backup and restore

7.6.1 Overview

Backup and restore

You can back up and restore the following data in the internal flash memory of the HMI device with a PC:

- Project and HMI device image
- Password list
- Recipe data
- License keys

Use one of the following tools for backup and restore:

- WinCC flexible
- ProSave

Note

Alternatively, use the control panel to back up to an external memory device.

General information

NOTICE
Power failure If a complete restore operation is interrupted due to power failure on the HMI device, the operating system of the HMI device may be deleted! In this case, you have to reset the HMI device to its factory settings.
Compatibility conflict If a message is output on the HMI device warning of a compatibility conflict during the restore operation, the operating system must be updated.

See also

Saving to external storage device (backup) (Page 153)

7.6.2 Backup and restore using WinCC flexible

Requirements

- No project is open on the configuring PC in WinCC flexible.
- The HMI device is connected to this configuring PC.
- The data channel is configured on the HMI device.

Procedure for backup

Proceed as follows:

1. On the configuring PC, select the "Communication settings" command in the menu "Project > Transfer" in WinCC flexible.
The "Communication Settings" dialog opens.
2. Select the type of HMI device.
3. Select the type of connection between the HMI device and the configuring PC.
Set the connection parameters.
4. Close the dialog with "OK".
5. Select the "Backup" command in the menu "Project > Transfer" in WinCC flexible.
The "Backup Settings" dialog opens.
6. Select the data to be backed up.
7. Select a destination folder and a file name for the "*.psb" backup file.
8. Set "Transfer" mode on the HMI device.
If automatic transfer mode is enabled on the HMI device, the HMI device automatically sets "Transfer" mode when a backup is initiated.
9. Start the backup operation in WinCC flexible with "OK" on the configuring PC.
Follow the instructions in WinCC flexible.
A status view opens to indicate the progress of the operation.

Result

The system outputs a message when the backup is completed.
The relevant data is now backed up on the configuring PC.

Procedure for restore

Proceed as follows:

1. On the configuring PC, select the "Communication settings" command in the menu "Project > Transfer" in WinCC flexible.

The "Communication Settings" dialog opens.

2. Select the type of HMI device.
3. Select the type of connection between the HMI device and the configuring PC.
4. Set the connection parameters.
5. Close the dialog with "OK".

6. Select the "Restore" command in the menu "Project > Transfer" in WinCC flexible.

The "Restore Settings" dialog opens.

7. Select the "*.psb" backup file to be restored from the "Open" field.

You can see the HMI device for which the backup file was created and the type of backup data the file contains.

8. Set "Transfer" mode on the HMI device.

If automatic transfer mode is enabled on the HMI device, the device automatically sets "Transfer" mode when a restore operation is initiated.

9. Start the restore operation in WinCC flexible with "OK" on the configuring PC.

If there are license keys both on the HMI device and in the backup, a dialog will appear. Use this dialog to establish whether you want to overwrite the license keys or abort the restore process.

- If necessary, abort the backup and first back up the HMI device's license keys.
- Then restart the restore process.

Follow the instructions in WinCC flexible.

A status view opens to indicate the progress of the operation.

Result

When the restore is successfully completed, the data backed up on the configuring PC is now on the HMI device.

See also

Transferring and transferring back license keys (Page 186)

Configuring the data channel (Page 136)

Operating modes (Page 160)

Data transmission options (Page 162)

7.6.3 Backup and restore using ProSave

Requirements

- The HMI device is connected to a PC on which ProSave is installed.
- The data channel is configured on the HMI device.

Procedure for backup

Proceed as follows:

1. From the Windows Start menu, start ProSave on the PC.
2. Select the HMI device type in the "General" tab.
3. Select the type of connection between the HMI device and the PC.
Set the connection parameters.
4. Select the data to be backed up in the "Backup" tab.
5. Select a destination folder and a file name for the "*.psb" backup file.
6. Set "Transfer" mode on the HMI device.

If automatic transfer mode is enabled on the HMI device, the HMI device automatically sets "Transfer" mode when a backup is initiated.

7. Start the backup operation in ProSave with "Start Backup".
Follow the instructions in ProSave.
A status view opens to indicate the progress of the operation.

Result

The system outputs a message when the backup is completed.
The relevant data is now backed up on the PC.

Procedure for restore

Proceed as follows:

1. From the Windows Start menu, start ProSave on the PC.
2. Select the HMI device type in the "General" tab.
3. Select the type of connection between the HMI device and the PC.
4. Set the connection parameters.
5. Select the "*.psb" backup file to be restored from the "Restore" tab.

You can see the HMI device for which the backup file was created and the type of backup data the file contains.

6. Set "Transfer" mode on the HMI device.

If automatic transfer mode is enabled on the HMI device, the device automatically sets "Transfer" mode when a restore operation is initiated.

7. Start the restore operation in ProSave on the PC with "Start Restore".

If there are license keys both on the HMI device and in the backup, a dialog will appear. Use this dialog to establish whether you want to overwrite the license keys or abort the restore process.

- If necessary, abort the backup and first back up the HMI device's license keys.
- Then restart the restore process.

8. Follow the instructions in ProSave.

A status view opens to indicate the progress of the operation.

Result

When the restore is successfully completed, the data backed up on the PC is now on the HMI device.

See also

Configuring the data channel (Page 136)

Operating modes (Page 160)

Data transmission options (Page 162)

Transferring and transferring back license keys (Page 186)

7.7 Updating the operating system

7.7.1 Overview

Updating the operating system

A compatibility conflict may occur when transferring a project to the HMI device. This is caused by different versions of the configuration software used and the HMI device image available on the HMI device. If there are different versions, the transfer is aborted. A message indicating a compatibility conflict is displayed on the configuration PC.

There are two ways to match the versions:

- Update the HMI device image if the project was created with the most recent version of the configuration software.
- Transfer a matching version of the HMI device image if you do not want to adapt the project for the HMI device to the most recent version of the configuration software for the project.

NOTICE
Data loss
All data on the HMI device, such as the project and licenses, will be deleted when you update the operating system.

Note

When WinAC MP is used, all data channel parameters are reset.

Note**Calibrating the touch screen**

After the update, you may have to recalibrate the touch screen.

7.7.2 Resetting factory settings

In ProSave or WinCC flexible, you can update the operating system with or without resetting to factory settings.

- Updating the operating system without resetting to factory settings

First, switch into "Transfer" mode on the HMI device or use the automatic transfer function if the project is active. Then start the operating system update in ProSave or WinCC flexible.

- Updating the operating system with resetting to factory settings

NOTICE
Loss of license keys The license keys on the HMI device will be deleted when resetting to factory settings. The license keys on the HMI device will be retained when updating the operating system without resetting to factory settings.

NOTICE
Data channels When resetting to factory settings, all data channel parameters are reset. The transfer can only be started following reconfiguration of the data channels.

Note

You have to perform an operating system update with reset to factory settings if the HMI device does not yet have an operating system or if the HMI device's operating system is corrupt.

First, start the operating system update in ProSave or WinCC flexible and switch the power on the HMI device off and on again when prompted.

7.7.3 Updating the operating system using WinCC flexible

Requirements

- No project is open on the configuring PC in WinCC flexible.
- The HMI device is connected to this configuring PC.
- The data channel is configured on the HMI device.

Procedure

Proceed as follows:

1. On the configuring PC, select the "Communication settings" command from the "Projekt > Transfer" menu in WinCC flexible.
The "Communication Settings" dialog opens.
2. Select the type of HMI device.
3. Select the type of connection between the HMI device and the configuring PC.
4. Set the connection parameters.
5. Close the dialog with "OK".
6. In WinCC flexible, select the command "OS Update" from the "Projekt > Transfer" menu.
7. In "Image path", select the HMI device image file "*.img".
The HMI device image files are available under "WinCC flexible Images" in the WinCC flexible installation folder or on the WinCC flexible installation CD.
In the output area, you are provided information on the version of the HMI device image file after it is opened.
8. Switch into "Transfer" mode on the HMI device.
If you have activated automatic transfer mode for the HMI device, the device automatically switches to "Transfer" mode when an update is initiated.
9. In WinCC flexible, select "Update OS" on the configuring PC to run the operating system update.
10. Follow the instructions in WinCC flexible.
During the operating system update a status view opens to indicate progress.

Result

A message is displayed when the operating system update is successfully completed.
This operation has deleted the project data from the HMI device.

7.7.4 Updating the operating system using ProSave

Requirements

- The HMI device is connected to a PC on which ProSave is installed.
- The data channel is configured on the HMI device.

Procedure

Proceed as follows:

1. From the Windows Start menu, start ProSave on the PC.
2. Select the HMI device type in the "General" tab.
3. Select the type of connection between the HMI device and the PC.
4. Set the connection parameters.
5. Select the "OS Update" tab.

6. In "Image path", select the HMI device image file "*.img".

The HMI device image files are available under "WinCC flexible Images" in the WinCC flexible installation folder or on the WinCC flexible installation CD.

In the output area, you are provided information on the version of the HMI device image file after it is opened.

7. Switch into "Transfer" mode on the HMI device.

If you have activated automatic transfer mode for the HMI device, the device automatically switches to "Transfer" mode when an update is initiated.

8. Select "Update OS" on the PC to run the operating system update.
9. Follow the instructions in ProSave.

During the operating system update a status view opens to indicate progress.

Result

A message is displayed when the operating system update is successfully completed.

This operation has deleted the project data from the HMI device.

7.7.5 Resetting to factory settings with WinCC flexible

Requirements

- No project is open on the configuring PC in WinCC flexible.
- The HMI device is connected to this configuration PC over the standard Ethernet cable.
- Have the MAC address of the Ethernet interface on your HMI device to hand.
 - The MAC address is displayed briefly when the HMI device is turned on.
 - The MAC address is displayed in the "PROFINET" dialog in the Control Panel.

Procedure - Setting the PC interface

1. Select "Start > Control Panel > Set PG / PC interface" on the configuration PC.
2. Select "S7ONLINE (STEP7) -> TCP / IP" from the "Application access point" area.
3. Select the interface which is connected to the HMI device from the "Interface parameterization used" area.
4. Confirm your entries.

Procedure - Restoring factory settings

Proceed as follows:

1. On the configuring PC, select the "Communication settings" command in the menu "Project > Transfer" in WinCC flexible.

The "Communication Settings" dialog opens.

2. Select the HMI device type from the "General" tab, and select "Ethernet" from the "Connection" area.
3. Enter an IP address.

Note

Possible address conflicts with incorrect IP address

Do not use a dynamic IP configuration for "Reset to factory settings".

Specify a unique IP address in which the configuration PC is located. For the duration of the update process, the HMI device is automatically assigned to the specified address.

If the HMI device has already been used with WinCC flexible or ProSave you can use the existing IP address for "Reset to factory settings."

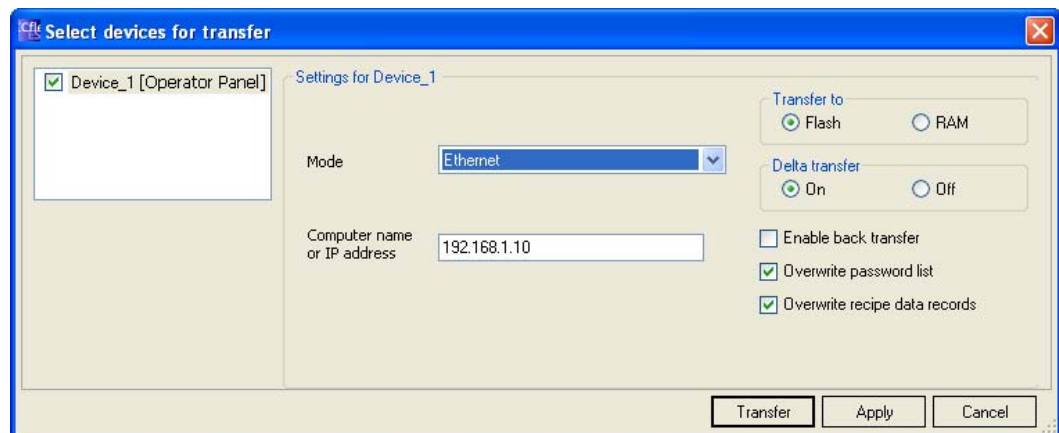

4. Confirm your entries.
5. In WinCC flexible, select the command "Update OS" in the "Project > Transfer" menu.
6. Activate the "Reset to factory settings" check box.

A text box opens where you can enter the MAC address.

7. Enter the HMI device's MAC address in the text box.
8. In "Image path", select the HMI device image file "*.img".

The HMI device image files are available under "WinCC flexible Images" in the WinCC flexible installation folder or on the WinCC flexible installation CD.

In the output area, you are provided information on the version of the HMI device image file after it is opened.

9. In WinCC flexible, select "Update OS" on the configuring PC to run the operating system update.
10. In the Control Panel of the HMI device, open the "OP Properties" dialog and select the "Device" tab.
11. Click on the "Reboot" button.
A query is opened.
12. Click on the "Prepare for Reset" button.
13. On the configuration PC, follow the instructions in WinCC flexible.
During the operating system update a status view opens to indicate progress.

Result

A message is displayed when the operating system update is successfully completed.

This operation has deleted the project data from the HMI device. The factory settings are reset.

Note

If you can no longer call the Control Panel on the HMI device, as the operating system is missing, switch off the HMI device. Then reset to factory settings and restart the HMI device.

If the HMI device doesn't start up, switch it off and then on again.

Note

Calibrating the touch screen

After the reset, you may have to recalibrate the touch screen.

7.7.6 Resetting to factory settings with ProSave

Requirement

- The HMI device is connected over the Ethernet to a PC on which ProSave is installed.
- Have the MAC address of the Ethernet interface on your HMI device to hand.
 - The MAC address is displayed briefly when the HMI device is turned on.
 - The MAC address is displayed in the "PROFINET" dialog in the Control Panel.

Procedure - Setting the PC interface

1. Select "Start > Control Panel > Set PG / PC interface" on the configuration PC.
2. Select "S7ONLINE (STEP7) -> TCP / IP" from the "Application access point" area.
3. Select the interface which is connected to the HMI device from the "Interface parameterization used" area.
4. Confirm your entries.

Procedure - Restoring factory settings

Proceed as follows:

1. From the Windows Start menu, start ProSave on the PC.
2. Select the HMI device type from the "General" tab, and select "Ethernet" from the Connection area.
3. Enter an IP address.

Note

Possible address conflicts with incorrect IP address

Do not use a dynamic IP configuration for "Reset to factory settings".

Specify a unique IP address of the subnet in which the configuration PC is located. For the duration of the update process, the HMI device is automatically assigned to the specified address of ProSave.

If the HMI device has already been used with WinCC flexible or ProSave you can use the existing IP address for "Reset to factory settings."

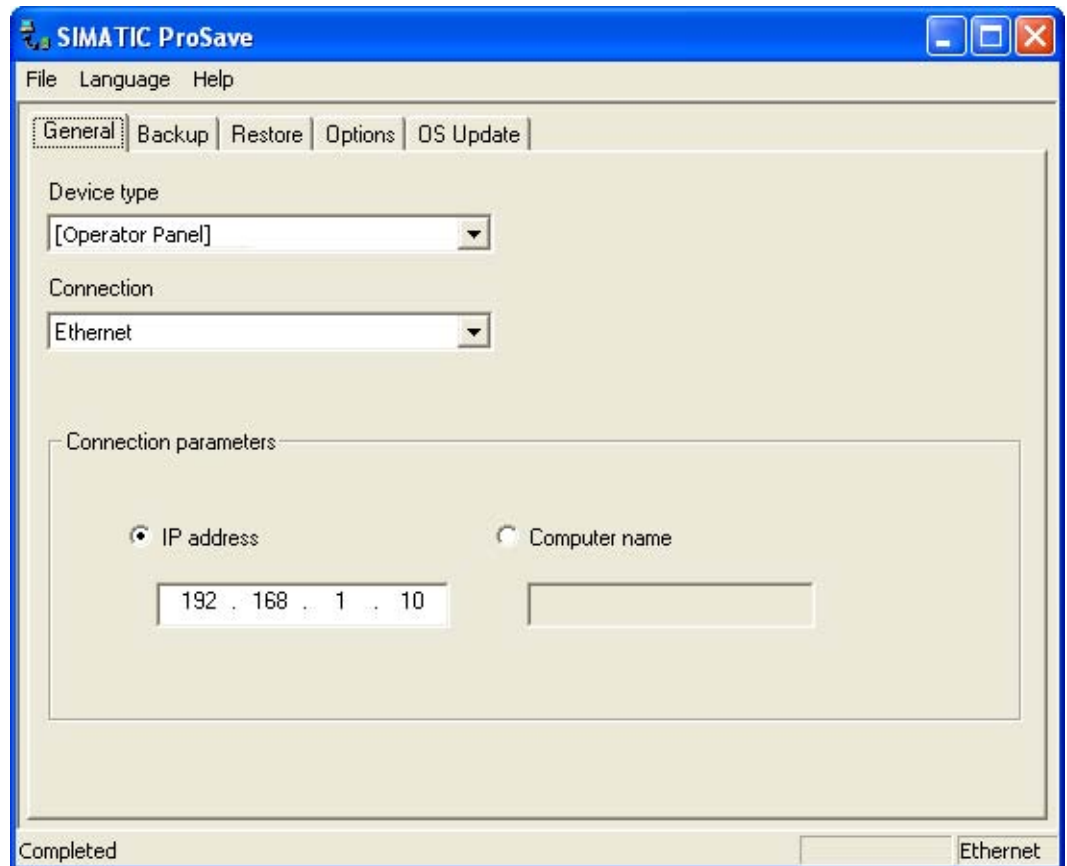

4. Change to the "OS Update" tab.
5. Activate the "Reset to factory settings" check box.
A text box opens where you can enter the MAC address.
6. Enter the HMI device's MAC address in the text box.
7. In "Image path", select the HMI device image file "*.img".
The HMI device image files are available under "WinCC flexible Images" in the WinCC flexible installation folder or on the WinCC flexible installation CD.
In the output area, you are provided information on the version of the HMI device image file after it is opened.
8. Select "Update OS" on the PC to start the "Reset to factory settings" process.
9. In the Control Panel of the HMI device, open the "OP Properties" dialog and select the "Device" tab.
10. Click on the "Reboot" button.
A query is opened.
11. Click on the "Prepare for Reset" button.
12. Follow the instructions in ProSave.
During the operating system update a status view opens to indicate progress.

Result

A message is displayed when the operating system update is successfully completed.

This operation has deleted the project data from the HMI device. The factory settings are reset.

Note

If you can no longer call the Control Panel on the HMI device, as the operating system is missing, switch off the HMI device. Then reset to factory settings and restart the HMI device.

If the HMI device doesn't start up, switch it off and then on again.

Note

Calibrating the touch screen

After the reset, you may have to recalibrate the touch screen.

7.8 Installing and removing options

7.8.1 Overview

Installing and removing options

You can install options on the HMI device, for example, additional programs developed especially for the HMI device.

You can also remove the option from the HMI device again.

Note

License key

A license key may be needed to run an option. The license key unlocks the option for use.

7.8.2 Installing and removing options using WinCC flexible

Requirements

- No project is open on the configuring PC in WinCC flexible.
- The HMI device is connected to this configuring PC.
- The data channel is configured on the HMI device.

Procedure for installing an option

Proceed as follows:

1. On the configuring PC, select the "Communication settings" command in the menu "Project > Transfer" in WinCC flexible.
The "Communication Settings" dialog opens.
2. Select the type of HMI device.
3. Select the type of connection between the HMI device and the configuring PC, then set the connection parameters.
4. Close the dialog with "OK".
5. Select the "Options" command in the menu "Project > Transfer" in WinCC flexible.
6. Select the desired option under "Available options".
7. Set "Transfer" mode on the HMI device.
If automatic transfer mode is enabled on the HMI device, the device automatically sets "Transfer" mode when the installation of an option is initiated.
8. Start the installation of the option in WinCC flexible on the configuring PC with the ">>" button.
Follow the instructions in WinCC flexible.
A status display appears indicating the progress of the installation.

Result

The option has now been installed on the HMI device.

Procedure for removing an option

Proceed as follows:

1. On the configuring PC, select the "Communication settings" command in the menu "Project > Transfer" in WinCC flexible.

The "Communication Settings" dialog opens.

2. Select the type of HMI device.
3. Select the type of connection between the HMI device and the configuring PC, then set the connection parameters.
4. Close the dialog with "OK".
5. Select the "Options" command in the menu "Project > Transfer" in WinCC flexible.
6. Press the "Device status" button to update the display.
7. Select the desired option under "Installed options".
8. Set "Transfer" mode on the HMI device.

If automatic transfer mode is enabled on the HMI device, the device automatically sets "Transfer" mode when the removal of an option is initiated.

9. Start the removal of the option in WinCC flexible on the configuring PC with the "<<" button.

Follow the instructions in WinCC flexible.

A status display appears indicating the progress of the removal.

Result

The option has now been removed on the HMI device.

7.8.3 Installing and removing options using ProSave

Requirements

- The HMI device is connected to a PC on which ProSave is installed.
- The data channel is configured on the HMI device.

Procedure for installing an option

Proceed as follows:

1. From the Windows Start menu, start ProSave on the PC.
2. Select the HMI device type in the "General" tab.
3. Select the type of connection between the HMI device and the PC, then set the connection parameters.
4. Select the "Options" tab.
5. Select the desired option under "Available options".
6. Set "Transfer" mode on the HMI device.

If automatic transfer mode is enabled on the HMI device, the device automatically sets "Transfer" mode when the installation of an option is initiated.

7. Start the installation of the option in ProSave with the ">>" button.

Follow the instructions in ProSave.

A status display appears indicating the progress of the installation.

Result

The option has now been installed on the HMI device.

Procedure for removing an option

Proceed as follows:

1. From the Windows Start menu, start ProSave on the PC.
2. Select the HMI device type in the "General" tab.
3. Select the type of connection between the HMI device and the PC, then set the connection parameters.
4. Select the "Options" tab.
5. Press the "Device status" button to update the display.
6. Select the desired option under "Installed options".
7. Set "Transfer" mode on the HMI device.

If automatic transfer mode is enabled on the HMI device, the device automatically sets "Transfer" mode when the removal of an option is initiated.

8. Start the removal of the option in ProSave with the "<<" button.

Follow the instructions in ProSave.

A status display appears indicating the progress of the removal.

Result

The option has now been removed on the HMI device.

7.9 Transferring and transferring back license keys

7.9.1 Overview

Transferring and transferring back license keys

With the purchase of an optional package, you obtain a specific user license with an associated license key. Once you have installed an option, transfer a license key to the HMI device. The license key unlocks an option for use.

You can also transfer back the license key from the HMI device to the storage location.

Note

You only transfer license keys with the Automation License Manager or WinCC flexible.

7.9.2 Transferring and transferring back license keys

Requirements

- When transferring or transferring back using WinCC flexible:
No project is open on the configuring PC in WinCC flexible.
- The HMI device is connected to this configuring PC.
- The data channel is configured on the HMI device.
- The storage location and the license key awaiting transfer are ready.

Procedure for transferring a license key

Proceed as follows:

1. Switch to "Transfer" mode on the HMI device.
2. When transferring using WinCC flexible:
Select the "License Keys" command in the menu "Project > Transfer".
The Automation License Manager opens.

When transferring using the Automation License Manager:
Start the Automation License Manager via the Windows Start menu.
3. In the Automation License Manager, select the command "Connect HMI device" in the menu "Edit > Connect target system".
The "Connect Target System" dialog opens.
4. Under "Device Type", select the appropriate HMI device type.
5. Select the type of connection from the "Connection" box.
6. Set the connection parameters.
7. Select "OK".

The connection to the HMI device is established. The connected HMI device is displayed in the left window of the Automation License Manager.
8. In the left window, select the source drive.

The right window displays the available license keys.
9. Drag one or more license keys from the right window and drop them on the HMI device in the left window.

The license keys are then transferred to the HMI device.

Result

The license key is transferred from the storage location to the HMI device.

Procedure for transferring a license key back

Proceed as follows:

1. Switch to "Transfer" mode on the HMI device.

2. When transferring back using WinCC flexible:

Select the "License Keys" command in the menu "Project > Transfer".
The Automation License Manager opens.

When transferring back using the Automation License Manager:

Start the Automation License Manager via the Windows Start menu.

3. In the Automation License Manager, select the command "Connect HMI device" in the menu "Edit > Connect target system".

The "Connect Target System" dialog opens.

4. Under "Device Type", select the appropriate HMI device type.

5. Select the type of connection from the "Connection" box.

6. Set the connection parameters.

7. Select "OK".

The connection to the HMI device is established. The connected HMI device is displayed in the left window of the Automation License Manager.

8. In the left window, select the HMI device.

The right window displays the available license keys.

9. Drag one or more license keys from the right window and drop them on the destination drive in the left window.

The license keys are transferred back to the storage location.

Result

The license key is transferred back from the HMI device to the storage location.

Operating a project

8.1 Overview

Configuration and process control phase

HMI devices can be used to operate and monitor tasks in process and production automation. The plant screens on the HMI devices are used to provide a clear overview of the active processes.

The HMI device project, which includes the plant screens, is created during the configuration phase. The configuration engineer defines which tasks the HMI device has in the process and defines the following in detail:

- Which process data is displayed on the individual HMI device
- Which plant components are controlled by this HMI device

The configuration engineer stores this information in the project's screens. The project is transferred to the HMI device during commissioning.

After transfer to the HMI device, current processes can be operated and monitored in the project's screens. The screens enable you to observe, for example, operational states, current process data and faults in a plant. Operating elements which are used to operate the process, for example buttons, I/O fields and alarm windows, are displayed in the screens.

Operator input options

The hardware of the HMI device determines which of the following operator control options are available:

- Touch screen

The operating elements shown in the dialogs are touch-sensitive. Touch objects are basically operated in the same way as mechanical keys. You activate operating elements by touching them with your finger. To double-click them, touch an operating element twice in succession.

- HMI device keyboard

The operating elements shown in the screens are selected and operated using the keys of the HMI device.

- External keyboard, connected via USB
- External mouse, connected via USB

CAUTION

Do not use any pointed or sharp objects when operating the touch screen. Otherwise this may damage the plastic membrane of the touch screen.

The following provides instructions for operating a project with the touch screen and the keyboard.

Operating a project with an external keyboard

An external keyboard can be used to operate a project in exactly the same way as with the HMI keyboard or screen keyboard.

Note

The function keys of the external keyboard are disabled.

Use the other keys of the external keyboard, which correspond to the HMI device keys in the description.

Operating a project with an external mouse

An external mouse can be used to operate a project in exactly the same way as with the HMI touch screen. Click the described operating elements with the mouse.

Unintentional actions

 CAUTION
Do not carry out several operations simultaneously. You may otherwise trigger unintentional actions. <ul style="list-style-type: none">• With touch control: Always touch only one operating element on the screen• With key control: Do not press more than two keys simultaneously

Observing the plant documentation

Some operations with the project may require in-depth knowledge about the specific plant on the part of the operator. Proceed with caution, for example, when you use jog mode. Further information on this may be available in your plant documentation.

Operation feedback from operating elements

The HMI device provides operation feedback as soon as it detects that an operating element has been selected. This operation feedback is independent of any communication with the PLC. Therefore, this operation feedback does not indicate whether the relevant action is actually executed or not.

Optical feedback from operating elements

The operating element receives the focus and is selected. The configuration engineer can also configure the selection of an operating element so that it deviates from the standard. Further information on this may be available in your plant documentation.

The type of optical feedback depends on the operating element:

- Buttons

The HMI device outputs different views of the "Pressed" and "Unpressed" states, provided the configuration engineer has configured a 3D effect:

- "Pressed" state:

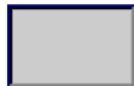

- "Unpressed" state:



The configuration engineer determines the appearance of a selected field, for example, line width and color for the focus.

- Invisible buttons

By default, invisible buttons are not displayed as pressed when they are touched. No optical operation feedback is provided in this case.

The configuration engineer may, however, configure invisible buttons so that their outline appears as lines when touched. This outline remains visible until you select another operating element.

- I/O fields

When you select an I/O field, the content of the I/O field is displayed against a colored background. With touch operation, a screen keyboard is displayed for the entering of values.

Acoustic feedback from operating elements

As soon as the HMI device detects a touch of the touch screen or that a key has been pressed, an acoustic signal is issued. You can activate or deactivate this acoustic operation feedback.

Note

The acoustic feedback is only possible if you interact with the project directly on the touch screen or press one of the keys of the HMI device. If you use an external mouse or keyboard for interaction, no acoustic signal is issued.

Acoustic signal for inadvertent operations

If you try to enter an invalid character, the HMI device issues an acoustic signal in accordance with the setting.

8.2 Direct keys

Introduction

Direct keys on the HMI device are used to set bits in the I/O area of a SIMATIC S7.

Direct keys enable operations with short reaction times that are, for example, a jog mode requirement.

NOTICE

Direct keys are still active when the HMI device is in "offline" mode.
--

NOTICE

If you operate a function key with direct key functionality in a running project, the direct key function is always executed, independent of the current screen contents.

Note

You can only use direct keys when there is a connection via PROFIBUS DP or PROFINET IO.

Direct keys result in additional basic load on the HMI device.

Direct keys

The following objects can be configured as a direct key:

- Buttons
- Function keys

You can also define image numbers in the case of HMI devices with touch operation. In this way, the project engineer can configure the direct keys on an image-specific basis.

Further information on configuring direct keys can be found in the "WinCC flexible Communication" system manual.

8.3 Setting the project language

Introduction

The HMI device supports multilingual projects. You must have configured a corresponding operating element which lets you change the language setting on the HMI device during runtime.

The project always starts with the language set in the previous session.

Requirements

- The required language for the project must be available on the HMI device.
- The language switching function must be logically linked to a configured operating element such as a button.

Selecting a language

You can change project languages at any time. Language-specific objects are immediately output to the screen in the new language when you switch languages.

The following options are available for switching the language:

- A configured operating element switches from one language to the next in a list
- A configured operating element directly sets the desired language

Further information on this may be available in your plant documentation

8.4 Entries using the touch screen

8.4.1 Overview

Screen keyboard

When you touch an operating element requiring entry on the HMI device touch screen, a screen keyboard appears. The screen keyboard is displayed in the following cases:

- An I/O field is selected for input
- A password must be entered for accessing a password-protected function

The screen keyboard is automatically hidden again when input is complete.

Based on the configuration of the operating element, the system displays different screen keyboards for entering numerical or alphanumerical values.

Note

The screen keyboard display is independent of the configured project language.

General procedure

The operating elements of a screen are operated by touching the touch screen.

Proceed as follows:

1. Touch the desired operating element within the screen.
2. Depending on the operating element, perform further actions. Detailed descriptions can be found under the respective operating element.

Examples:

- I/O field: Enter numerical, alphanumeric or symbolic values in the I/O field
- Symbolic I/O field: Select an entry from the drop down list box
- Slider control: Move the slider control

Procedure for text boxes

Values are entered in the project text boxes. Based on your configuration, the values are saved to tags and transferred, for example, to the PLC.

Proceed as follows:



1. Touch the desired text box within the screen.

The screen keyboard opens.

Depending on your configuration, you can enter values in the text box in the following manner:

- Numerical values, for example decimal numbers, hexadecimal numbers, binary values
- Alphanumerical values, for example digits and letters
- Date/time

2. Enter the value.

3. Confirm your entry with  or discard your entry with the button .

8.4.2 Entering and editing numerical values

Numerical screen keyboard

When you touch an operating element for numerical input on the HMI-device touch screen, the numerical screen keyboard appears. This is the case, for example, for a text box. The screen keyboard is automatically hidden again when input is complete.



Note

Opened screen keyboard

PLC job 51 "Select screen" has no effect while the screen keyboard is open.

Formats for numerical values

You can enter values in numerical text boxes based on the following formats:

- Decimal
- Binary
- Hexadecimal

Note

Entry of hexadecimal values

When you enter values in hexadecimal format, the alphanumerical screen keyboard opens.

Checking numerical value limits

Tags can be assigned limit values. If you enter a value that lies outside of this limit, it will not be accepted, for example, 80 with a limit value of 78. In this case the HMI device will deliver a system alarm, if an alarm window is configured. The original value is displayed again.

Decimal places of numerical values

The configuration engineer can define the number of decimal places for a numerical text box. The number of decimal places is checked when you enter a value in this type of I/O field.

- Decimal places in excess of the limit are ignored
- Empty decimal places are filled with "0"

Procedure

Numerical values can be entered character-by-character via the buttons on the numerical screen keyboard.

Proceed as follows:

1. Touch the desired operator control on the screen.



The numerical screen keyboard opens. The existing value is displayed in the screen keyboard and is selected.

2. Enter the value.

The keys with for example the letters G to Z are available to enter a hexadecimal value; however, the characters are not entered. Depending on the settings, the HMI device outputs an audible signal.

You have the following options to enter a value:

- The selected value is deleted when you enter the first character. Completely reenter the value.



- Use the  and  keys to move the cursor within the current value. You can now edit the characters of the current value or add characters.

Use the  key to delete the character to the left of the cursor. If the value is selected, use this key to delete the selected part of the value.

The  key deletes the character positioned to the right of the cursor. If the value is selected, use this key to delete the selected part of the value.

- Use the  key to display the infotext of the I/O field.

This key is only enabled if infotext has been configured for the input object or the current screen.

3. Use the  key to confirm your entry or cancel it with . Either action closes the screen keyboard.

Result

You have changed the numerical value or entered a new one.

8.4.3 Entering and editing alphanumerical values

Alphanumerical screen keyboard

When you touch an operating element for alphanumerical input on the HMI-device touch screen, the alphanumerical screen keyboard appears. This is the case, for example, for a text box. The screen keyboard is automatically hidden again when input is complete.



Note

Opened screen keyboard

PLC job 51 "Select screen" has no effect while the screen keyboard is open.

Language change

Language change in the project has no influence on the alphanumerical screen keyboard. This means you cannot enter Cyrillic or Asian characters.

Keyboard levels

The alphanumerical screen keyboard has various levels.

- Normal level
- Shift level

If you change the levels with key , the key assignments change.

Procedure

Alphanumerical values can be entered character-by-character via the buttons on the alphanumerical screen keyboard.

Proceed as follows:



1. Touch the desired operator control on the screen.

The alphanumerical screen keyboard opens. The existing value is displayed in the screen keyboard and is selected.

2. Enter the value.

You have the following options to enter a value:

- The selected value is deleted when you enter the first character. Completely reenter the value.

- Use the  and  keys to move the cursor within the current value. You can now edit the characters of the current value or add characters.



Use the  key to delete the character to the left of the cursor. If the value is selected, use this key to delete the selected part of the value.

The  key deletes the character positioned to the right of the cursor. If the value is selected, use this key to delete the selected part of the value.

- Using key  it is possible to switch between the keyboard levels of the screen keyboard. On switchover, the key assignments of the screen keyboard change.

- Use the  key to display the infotext of the I/O field.

This key is only enabled if infotext has been configured for the input object or the current screen.

3. Use the  key to confirm your entry or cancel it with . Either action closes the screen keyboard.

Result

You have changed the alphanumeric value or entered a new one.

8.4.4 Entering the date and time

Entering the date and time

Enter the date and time in the same way you enter alphanumerical values.

Note

When entering the date and time, please note that the format is determined by the configured project language.

8.4.5 Entering symbolic values

Drop down list

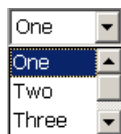

Operating elements for entering symbolic values offer you a list from which you can select the input values. When you touch a symbolic I/O field on the HMI device touch screen, the following drop down list opens.



Procedure

Proceed as follows:

1. Touch the required operating element.

The drop down list of the operating element opens. Select  and  to scroll in the drop down list.

2. Touch the required entry in the drop down list.

The selected entry is accepted as an entry.

Result

You have changed the symbolic value or entered a new one.

8.4.6 Displaying infotext

Purpose

The configuration engineer uses infotext to provide additional information and operating instructions. The configuration engineer can configure infotext on screens and operating elements.

The infotext of an I/O field may contain, for example, information on the value to be entered.

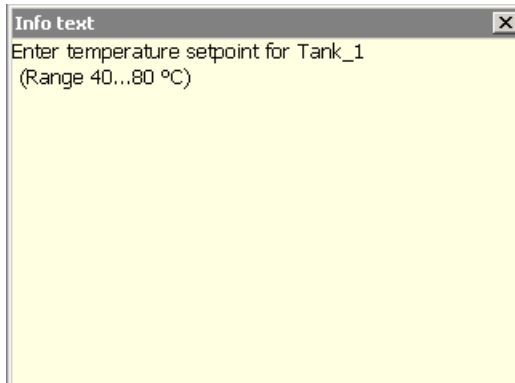

Opening infotext for operating elements

1. Touch the required operating element.

The screen keyboard opens. You can see from the appearance of the **Help** key whether infotext has been configured for the operating element or the current screen.

2. Touch the **Help** key on the screen keyboard.

The infotext for the operating element is displayed. If there is no infotext for the selected screen object, the infotext for the current screen is displayed, if it has been configured.

You can scroll through the contents of long infotext with  and .

Note

Switching between displayed infotext

The configuration engineer can configure infotext for an I/O field and the associated screen. You can switch between two infotexts by touching the infotext window.

3. Close the displayed infotext by pressing .

Alternative procedure

Depending on your configuration, infotext can also be called via a configured operating element.

Refer to your plant documentation to find any additional information on this topic.





8.5 Entries using the keys

8.5.1 Control keys



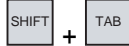











Introduction







The following tables show the control keys with which you operate the project. You will also find detailed descriptions under the individual operating elements.

Select operating elements





Key	Functions	Description
 	Tabulator	Selects the next/previous operating element in the tab sequence.
   	Cursor keys	Selects the next operating element to the left, right, above or below the current screen object. Navigates in the operating element.

Using operating elements

Key	Functions	Description
   	Position the cursor	Positions the cursor within an operating element, for example in the I/O field.
 	Scroll back	Scrolls back a page in a list.
  	Scroll to the beginning	Scrolls to the beginning of a list.
 	Scroll forward	Scrolls one page forward in a list.
  	Scroll to the end	Scrolls to the end of a list.

Key	Functions	Description
	Enter key	<ul style="list-style-type: none"> Operates buttons. Accepts and ends an entry. Opens a drop down list box. Toggles within a text box between character mode and normal mode. <p>In character mode, a single character is selected. In this mode, you can advance in the character set using the cursor keys.</p>
	Cancel	<ul style="list-style-type: none"> Deletes the characters of a value entry and restores the original value. Closes the active dialog.
	Delete characters	Deletes the character to the right of the current cursor position.
	Delete characters	Deletes the character to the left of the current cursor position.
	Open drop down list box	Opens a drop down list box.
	Accept value	Accepts the selected value in the drop down list box without closing the list.

Enter key combinations

Key	Functions	Purpose
	Toggle key assignment	<p>Switches over key assignment of keys with multiple assignment.</p> <ul style="list-style-type: none"> No LED is lit: The number assignment is enabled. Pressing the button once toggles to letter assignment. An LED is lit: The left or right letter assignment is enabled. <p>Each time the key is pressed, the system toggles between the left letter assignment, the right letter assignment and the number assignment.</p>
	Toggle between upper-case and lower-case	Used in key combinations, for example for entering upper-case letters.
	Switch to additional key assignment	<p>Some of the keys contain a blue imprinted key assignment, for example the "%" character.</p> <p>Used in key combinations for the blue key assignment.</p>
	General control function	Used in key combinations
	General control function	Used in key combinations

Acknowledge alarms

Key	Functions	Description
	Acknowledge	Acknowledges the currently displayed fault alarm or all the alarms of an alarm group as group acknowledgment. The LED lights up as long as unacknowledged fault alarms are active.

Displaying infotext

Key	Functions	Description
	Displaying infotext	Opens a window with the configured infotext at the selected object, for example alarm or I/O field. If an infotext exists for the selected object, the LED lights up.





Multi-key operation

Unwanted actions may be triggered, if the operator unintentionally actuates a key combination.



 CAUTION
<p>Unintentional actions</p> <p>In "Online" mode, simultaneous operation of more than two keys may cause unintentional actions in the plant.</p> <p>Never press more than two keys simultaneously.</p>

8.5.2 Example: enter characters using the alphanumeric keyboard

Using the same keys of the alphanumeric keyboard you can enter up to six different characters. The entry result depends on the combination of the keys pressed.

The values "5", "M", "m", "N", "n" and "%" are entered using the same key  of the keyboard. You can use the keys ,  and  to switch between the different assignments.

The following table shows the entry options using the key .

Key 	Key 	Key 	Result
No LED is lit	Not pressed	Not pressed	5
Left LED is illuminated.	Not pressed	Not pressed	m
Left LED is illuminated.	Pressed	Not pressed	M
Right LED is illuminated.	Not pressed	Not pressed	n
Right LED is illuminated.	Pressed	Not pressed	N
Not relevant	Not relevant	Pressed	%

8.5.3 Function keys

Function keys

Function key assignment is defined during configuration. The configuration engineer can assign function keys globally and locally.

Function keys with global function assignment

A globally assigned function key always triggers the same action on the HMI device or in the PLC irrespective of the screen displayed. Such an action could be, for example, the activation of a screen or the closure of an alarm window.

Function keys with local function assignment

A function key with local function assignment is screen-specific and is therefore only effective within the active screen.

The function assigned locally to a function key can vary from screen to screen.

The function key of a screen can be assigned one function only, either a global or local one. The local assignment function takes priority over the global setting.

The configuration engineer can assign function keys in such a way that you can operate operating elements with function keys, for example, the alarm view, trend view, recipe view or Status Force.

8.5.4 General procedures

Introduction

The control keys and function keys of the HMI device are available for key control

General procedure

The operating elements of a screen are operated using the control keys of the HMI device.

Proceed as follows:

1. Continue to press the key  or the cursor keys until the required operating element is selected on the screen.
2. Depending on the operating element, perform further actions. Detailed descriptions can be found under the respective operating element.

Examples:

- I/O field: Enter numerical, alphanumeric or symbolic values in the I/O field
- Slider control: Move the slider control

3. Confirm the operation with the key  or abort the operation with the key .

8.5.5 Entering and editing numerical values

Formats for numerical values

You can enter values in numerical text boxes based on the following formats:

- Decimal
- Hexadecimal
- Binary

Limit value test of numerical values

Tags can be assigned limit values. If you enter a value that lies outside of this limit, it will not be accepted, for example, 80 with a limit value of 78. In this case the HMI device will deliver a system alarm, if an alarm window is configured. The original value is displayed again.

Procedure

Numerical and alphanumeric values can be entered in character mode using the system keys.

Proceed as follows:



1. Select the desired text box within the screen with .

The existing value is selected in the text box.

2. Enter the value using the numerical keypad.

You have the following options to enter a value:

- The existing value is deleted when you enter the first character. Completely reenter the value.
- Press  and a cursor key simultaneously. The selection of the field content is canceled. Move the cursor in the existing value. You can now edit the characters of the current value or add characters.

The  key deletes the character positioned to the right of the cursor. Use the  key to delete the character to the left of the cursor.

To enter the hexadecimal characters "A" to "F", switch the numerical keypad to letter assignment using the key .

- If the LED of the  key is lit, infotext is available for the selected object or the current screen.

Use the key  to display the infotext for the operating element or current screen.

3. Select  to confirm your entry.

Result

You have changed the numerical value or entered a new one.

8.5.6 Entering and editing alphanumerical values

Procedure

Alphanumerical values can be entered in character mode using the system keys.

Proceed as follows:



1. Select the desired text box within the screen with .

The existing value is selected in the text box.

2. Enter the value using the system keys.

You have the following options to enter a value:

- The existing value is deleted when you enter the first character. Completely reenter the value.
- Press  and a cursor key simultaneously. The selection of the field content is canceled. Move the cursor in the existing value. You can now edit the characters of the current value or add characters.

The  key deletes the character positioned to the right of the cursor. Use the  key to delete the character to the left of the cursor.

To enter letters, switch the numerical keypad to letter assignment using the key .

- If the LED of the  key is lit, infotext is available for the selected object or the current screen.

Use the key  to display the infotext for the operating element or current screen.

3. Select  to confirm your entry.

Result

You have changed the alphanumeric value or entered a new one.

8.5.7 Entering the date and time

Entering the date and time

Enter the date and time in the same way you enter alphanumerical values.

Note

When entering the date and time, please note that the format is determined by the configured project language.

8.5.8 Entering symbolic values

Drop down list



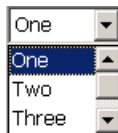



When you select a symbolic I/O field, a drop down list opens.



Procedure

Symbolic values are selected from the entries of a drop down list.

Proceed as follows:

1. Select the desired symbolic text box within the screen with .
2. Open the drop down list using the key . The drop down list opens.
3. Select the required entry using the cursor keys ,  or .
4. Select  to confirm your entry.

Result

You have changed the symbolic value or entered a new one.

8.5.9 Displaying infotext

Purpose

The configuration engineer uses infotext to provide additional information and operating instructions. The configuration engineer can configure infotext on screens and operating elements.

The infotext of an I/O field may contain, for example, information on the value to be entered.

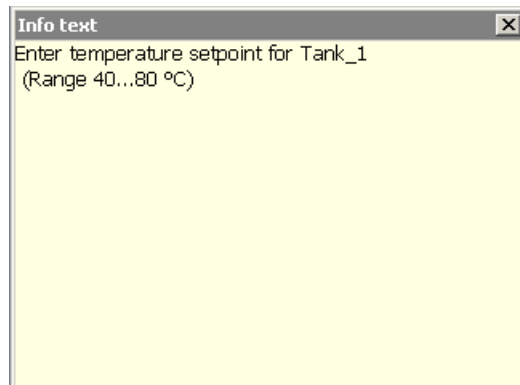

If the LED of the key  lights up, an infotext has been configured for the selected display object or for the current screen.

Procedure

1. Press .

The infotext for the selected screen object is displayed. If there is no infotext for the selected screen object, the infotext for the current screen is displayed, if it has been configured.

You can scroll through the contents of long infotexts using the cursor keys  and .

Note

Switching between displayed infotext

The configuration engineer can configure infotext for an I/O field and the associated screen. You can switch between two infotexts by pressing the key .

2. Close the infotext by pressing key .

Alternative procedure

Depending on your configuration, infotext can also be called via a function key or via an existing operating element.

Refer to your plant documentation to find any additional information on this topic.

8.6 Bar and gauge

Bar

The bar is a dynamic display object. The bar displays a value from the PLC as a rectangular area. The bar allows you to recognize the following at a glance:

- The distance of the current value from the configured limit values
- Whether a set point value has been reached

The bar can display values such as fill levels or batch counts.

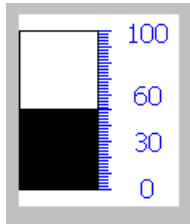

Layout

The layout of the bar depends on the configuration:

- The bar may feature a scale of values
- The configured limit values can be indicated by lines
- Color changes can signal when a limit value has been exceeded or has not been reached

Gauge

The gauge is a dynamic display object. The gauge displays numeric values in analog form by means of a pointer. This enables an operator at the HMI device to see at a glance if the boiler pressure is in the normal range, for example.

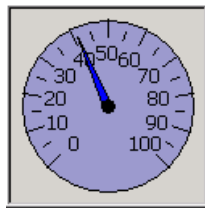

Layout

The layout of the gauge depends on the configuration:

- A trailing pointer can display the maximum value reached so far on the scale. The trailing pointer is reset when the screen is reloaded
- The label on the scale can show the measured variable, for example boiler pressure and the physical unit, for example bar

Operation

The bar and the gauge are for display only. Both objects cannot be controlled by the operator.

8.7 Operating the switch

Introduction

The switch is an operating element and display object with two predefined switching states, for example "On" and "Off". Switches can signalize the state of a plant section, for example if a motor is running or not. At the same time, you can use the switch to change the state of the corresponding plant section via the HMI device, for example from "On" to "Off".

Layout

The layout of the switch depends on the configuration:

- Switch with slider

The two states are displayed by the position of the slider

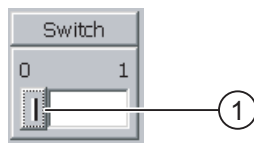

① Slider

- Switch with text or graphic

The two states are displayed by the label on the slider

Depending on the switching state, the switch is labeled with one of two texts or one of two graphics.

Examples:

"Backward" or "Forward"

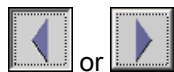

Procedure using the touch screen

- Switch with slider

Proceed as follows:

Move the slider to the other position or double-click the slider area



- Switch with text or graphic

Proceed as follows:

Touch the switch

Procedure using the keys

Proceed as follows:

1. Select the desired switch within the screen with .
2. Press .

Result

The switch changes its appearance. The associated value is switched.

8.8 Operating the trend view

Trends

Trends continuously display the current process data or process data from a log.

Trend view

Trends are displayed in the trend view. A trend view can display several trends simultaneously.

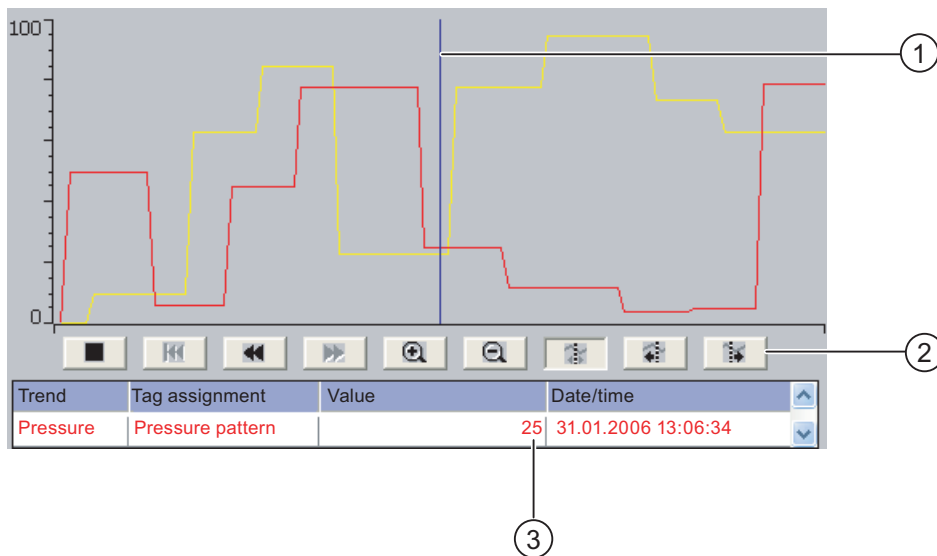

- ① Ruler
- ② Buttons for trend operation
- ③ Trend value in the value table

Layout and operation

The layout and operation of the trend view depends on the configuration. The configuration engineer determines, for example, the following:

- Appearance of the trend view, the axes, value ranges and labels
- Operating options of the trend view
- Limit values for the trend values
- The change of color of the trend in the event of limit violation

Refer to your plant documentation to find any additional information on this topic.

Value table

The trend values can be read from the value table if this is configured:

- When the ruler is displayed, the trend values are shown at a position of the ruler in the value table
- When the ruler is hidden, the latest trend values are displayed in the value table

Ruler

When configured, a ruler is available to provide an exact reading of the trend values in the value table.

















You can move the ruler to the desired position of the trend view.

Operation

The trend view can be operated as follows:

- Enlarge or reduce the time interval displayed
- Scroll forward or back by one display width
- Stop and resume trend recording
- Move the ruler
- Hide and display the ruler

The following table shows the trend view buttons:

Buttons	Key combination	Function
		Stops or continues trend recording.
	CTRL +  + 	Enlarges the displayed time section.
	CTRL +  + 	Reduces the displayed time section.
	SHIFT + 	Scrolls one display width backwards (to the left)
	SHIFT + 	Scrolls one display width forwards (to the right)
	CTRL + ENTER	Scrolls back to the beginning of the trend recording. The start values of the trend recording are displayed there.
	CTRL + ALT + 	Moves the ruler backwards (to the left)
	CTRL + ALT + 	Moves the ruler forwards (to the right)
		Shows or hides the ruler.

In addition, the configuration engineer can configure function keys or operating elements with which you can control trend views.

Refer to your plant documentation to find any additional information on this topic.



Touch operation

Touch the required button in the trend view.

The position of the ruler can also be changed by means of touching and dragging the ruler on the touch screen.

Procedure using the keys

Proceed as follows:

1. Using the key  select the desired button within the trend view.
2. Confirm your entry by pressing the key .

8.9 Operating the slider control

Introduction

The slider control can be used to monitor and change process values within a defined range. The slider control can also be configured without a slider. In this case, you cannot enter a value. The slider control is then only used for displaying values.

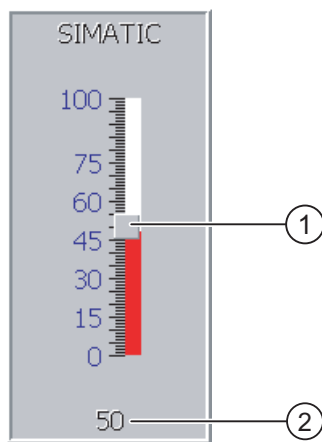

- ① Slider control for entering values
- ② Value display with current value

Layout

The layout of the slider control depends on the configuration:

- The slider control can contain a label and a setting range
- The current value can be displayed below the area of the slider control

Procedure using the touch screen

Proceed as follows:

1. Touch the slider of the desired slider control.
2. Move the slider to the required value.
If a value display has been configured, you can check the exact value that has been set.
3. Release the slider.

Key control

The following table shows the control keys used to set the slide to a desired value:

Key combination	Description
SHIFT + ▲ or SHIFT + ►	Increase value by 1
SHIFT + ▼ or SHIFT + ◀	Reduce value by 1
▲ HOME	Increase value in 5% increments.
▼ END	Decrease value in 5% increments.
F _N + ▲ HOME	Set maximum value
F _N + ▼ END	Set minimum value

Procedure using the keys

Proceed as follows:

1. Using the key TAB mark the desired switch within the screen.
2. Move the slider to the required value.
If a value display has been configured, you can check the exact value that has been set.

Result

The set value is applied.

8.10 Operating the Status Force

8.10.1 Overview

Application

You read or write access values of the connected PLC directly with Status Force. Status Force allows you to monitor or change addresses of the PLC program, etc. You don't need to connect an additional programming device or additional PC to the PLC.

Note

Status Force can only be used in combination with SIMATIC S5 or SIMATIC S7.

Layout

The layout of Status Force depends on the configuration.

The figure shows the general layout of Status Force. A value can be monitored or controlled on every line.

The following figure shows an example of Status Force.

Connection	Type	Offset	Format	Control Value
PLC_1	M	120	DEC	33
PLC_1	T	40	T	24,00
PLC_1	O	50	DEC	0
PLC_1	O	50	HEX	0A0D

The configuration engineer specifies which columns appear in Status Force.



The table shows the significance of all configurable columns.

Column	Functions
"Connection"	The PLC whose address ranges must be displayed.
"Type", "DB Number", "Offset", "Bit"	The address range of the value
"Data Type", "Format"	The data type of the value
"Status Value"	The value read from the specified address.
"Control Value"	The value to be written to the specified address.

Further information on this may be available in your plant documentation

Operating elements

Depending on your configuration, you can operate the Status Force using the following buttons:

Buttons	Functions
	"Read" button Updates the display in the "Status Value" column. This button engages when it is pressed. You cannot operate any text boxes until the button is actuated again and the refresh is stopped.
	"Write" button Applies the new value in the "Control Value" column. The control value is written to the PLC.

8.10.2 Touch operation

Operator input options

Status Force can be operated as follows:

- Change the column sequence
- Read the status values of the connected PLC
- Enter values and transfer them to the PLC

Change column sequence

Depending on the configuration, you can change the column sequence of Status Force.

Proceed as follows:

1. Touch the column header which you wish to exchange with a different column header
2. Keeping the touch screen pressed, move the column heading to the column heading you wish to exchange it with

Result

The columns are displayed in the modified sequence.

Procedure for reading the status value

Proceed as follows:

1. Enter the address and the desired format of a value for each line. Touch the respective columns to display the screen keyboard.
2. Once you have entered all of the desired values, touch the  button.

Result

All values are read cyclically by the PLC and entered in the "Status Value" column until the  button is touched again.

Requirements for forcing

The following requirements must be fulfilled in order to force values:

- The "Control Value" column must be available
- The "Write" button must be available

Procedure for forcing a value

Proceed as follows:

1. Enter the address of a value for each line. Enter the desired value in the "Control Value" column. Touch the respective columns to display the screen keyboard.
2. Once you have entered all of the desired values, touch the  button.

Result

The values from the "Control Value" column are transferred once to the PLC.

8.10.3 Key control









Operator input options

Status Force can be operated as follows:

- Change the column width.
- Read the status values of the connected PLC
- Enter values and transfer them to the PLC

Key control

The following table lists the key combinations for operating the Status Force:

Keys	Functions
CTRL + 	Operates the "Read" button.
CTRL + ENTER	Operates the "Write" button.
CTRL +  CTRL + 	Selects the first/last field in the current line.
CTRL +  CTRL + 	Selects the first/last field in the current column.
CTRL + 	Deletes the current line. Otherwise: Do not select a PLC in the "Connection" column.
ENTER	Opens selection box.
CTRL + ALT + 	Increases the width of the current column.
CTRL + ALT + 	Decreases the width of the current column.
CTRL + 	Optimizes column width.



Procedure for reading the status value

Proceed as follows:

1. Enter the address and format of the status value for each status value you wish to read in one line. Select the respective fields and enter the values using the keyboard.

2. Press  + .

Result

All status values are read cyclically from the PLC and entered in the "Status Value" column until the  +  keys are pressed again.



Requirements for forcing

The following requirements must be fulfilled in order to force values:

- The "Control Value" column must be available
- The "Write" button must be available

Procedure for forcing a value

Proceed as follows:

1. Enter the address of a value for each line. Enter the desired control value in the "Control Value" column. Select the respective fields and enter the values using the keyboard.
2. Once you have entered all of the desired control values, press the  +  key.

Result

The values from the "Control Value" column are transferred once to the PLC.

Alternative procedure

Alternatively, you can also select the buttons  and  using the key  and operate it using key .

8.11 Operating the Sm@rtClient view

8.11.1 Overview

Application

The Sm@rtClient view enables you to monitor and remotely operate the current project of a remote HMI device. With the correct configuration, several equal priority HMI devices can access a remote HMI device.

Note

If another HMI device accesses your HMI device via the Sm@rtClient view, this leads to an additional load on your HMI device.

Layout

In the Sm@rtClient view, the remote HMI is displayed with the complete layout.

Depending on the configuration, you can monitor and also operate this screen.

You can also operate the function keys like buttons on an HMI device with a touch screen.

Monitoring mode

On a Sm@rtClient view which is configured for monitoring mode, you can only monitor the remote HMI device. You cannot control its operation.

Operation

Note

It is not possible to operate the direct keys of the remote HMI device from the local HMI device.

The available operating elements depend on the HMI devices used:

- Same type of HMI devices
You can operate the project of the remote HMI device with the operating elements of your HMI device
- Operate keys from a local touch screen
All the keys of the remote HMI device are displayed as buttons on the touch screen. You can also touch them to operate them
- Touch operation from a local HMI device using keys
You operate the buttons in the usual manner.

8.11.2 Touch operation

Operator input options

The Sm@rtClient view can be operated as follows:

- Starting remote control
- Forcing permission
- Ending remote operation

Procedure for starting remote operation

Proceed as follows:

1. On the HMI device change to the screen with the Sm@rtClient view.

The following options are available for establishing the connection to the remote HMI device:

- The connection is established automatically.
- The connection must be established by touching the appropriate button.

Depending on the configuration, you may be required to enter the address of the remote HMI device and a password.

2. The current screen of the project running on the remote device is displayed on the screen of your HMI device.
3. You can now monitor and control this screen depending on your configuration.

Scroll bars are displayed if the screen of the remote HMI device is larger than that of the current HMI device.

Procedure for forcing permissions

If several HMI devices have access to a HMI device, only one HMI device has operating permission at any one time.

Two cases must be distinguished for this case:

- If another HMI device is already controlling the remote HMI device, if configured accordingly, you can force operating permission for the remote HMI device
 - You are trying to operate the remote HMI device
 - A dialog appears in which you are prompted to enter the appropriate password for forcing remote control
 - You are now authorized to operate the remote HMI device
- If another HMI device is accessing your HMI device via the Sm@rtClient view, you can force local operating permission for your HMI device
 - Touch the screen of your HMI device five times consecutively
 - You are given permission to operate your local HMI device

Procedure for ending remote control

You can end monitoring and control of a remote HMI device with one of the following methods depending on the configuration:

- Touch a button configured for this action
- Exit the screen containing the Sm@rtClient view
- If configured, a menu is displayed after you have touched an empty space over a longer period. Select the "Close" menu item.

Further information on this may be available in your plant documentation

8.11.3 Key control

Operator input options

The Sm@rtClient view can be operated as follows:

- Starting remote control
- Forcing permission
- Ending remote control

Procedure for starting remote operation

Proceed as follows:





1. On the HMI device change to the screen with the Sm@rtClient view.

The following options are available for establishing the connection to the remote HMI device:

- The connection is established automatically.
- Continue to press the key  until the Sm@rtClient view is selected.

Depending on the configuration, you may be required to enter the address of the remote HMI device and a password.

The connection is established. The current screen of the project running on the remote device is displayed on the screen of your HMI device.

2. You can now monitor and control this screen depending on your configuration.
3. Scroll bars are displayed if the screen of the remote HMI device is larger than that of the current HMI device. Move the scroll bars in the direction required using keys  + 
or  + .

Procedure for forcing permissions

If several HMI devices access an HMI device, only one HMI device has permission to operate.

Two cases must be distinguished for this case:



- If another HMI device is already controlling the remote HMI device, if configured accordingly, you can force operating permission for the remote HMI device
 - You are trying to operate the remote HMI device
 - A dialog appears in which you are prompted to enter the appropriate password for forcing remote control

You are now authorized to operate the remote HMI device
- If another HMI device is accessing your HMI device via the Sm@rtClient view, you can force local operating permission for your HMI device
 - Press  five times consecutively.

You are given permission to operate your local HMI device

Procedure for ending remote control

You can end monitoring or control of a remote HMI device with one of the following methods depending on the configuration:

- Press the key configured for this
- Exit the screen containing the Sm@rtClient view
- If configured, display a menu with  + . Select the desired menu command with  and the respective identification letter.

Further information on this may be available in your plant documentation.

8.12 Project security

8.12.1 Overview

Design of the security system

The configuration engineer can protect the operation of a project by implementing a security system.

The security system is based on authorizations, user groups and users.

If operating elements protected by a password are operated, the HMI device first requests that you log on. A logon screen is displayed in which you enter your user name and password. After logging on, you can operate the operating elements for which you have the necessary authorizations.

The logon dialog can be set up by the configuration engineer via an individual operating element.

In the same way, the configuration engineer can set up an operating element to log off. After logging off, objects assigned password protection can no longer be operated; to do so, log on again.

Further information on this may be available in your plant documentation.

User groups and authorizations

Project-specific user groups are created by the configuration engineer. The "Administrators" and "PLC User" groups are included in all projects by default. User groups are assigned authorizations. Authorization required for an operation is specifically defined for each individual object and function in the project.

Users and passwords

Each user is assigned to exactly one user group.

The following people are allowed to create users and assign them passwords:

- The configuration engineer during configuration
- The administrator on the HMI device
- A user with user management authorization on the HMI device

Irrespective of the user group, each user is allowed to change his own password.

Logoff times

A logoff time is specified in the system for each user. If the time between any two user actions, such as entering a value or changing screens, exceeds this logoff time, the user is automatically logged off. The user must then log on again to continue to operate objects assigned password protection.

Backup and restore

The user data is encrypted and saved on the HMI device to protect it from loss due to power failure.

The users, passwords, group assignments and logoff times set up on the HMI device can be backed up and restored. This prevents you having to enter all of the data again on another HMI device.

NOTICE

The currently valid user data is overwritten in the following cases:

- Depending on the transfer settings, when the project is transferred again
- Upon restore of a backed-up project
- Upon import of the user administration via an operating element. Further information on this may be available in your plant documentation

The retransferred or restored user data and passwords are valid with immediate effect.

Limits for user, password and user View

	Number of characters
Length of user name, maximum	40
Length of password, minimum	3
Length of password, maximum	24
Entries in user view, maximum	50

8.12.2 User view

Application

The user view is used to display the users on the HMI device:

- All users on the HMI device are displayed in the user view to the administrator or to a user with administrator authorizations
- If you are a user without user management authorization, you can only see your personal user entry

The authorizations of a user after logging on depends on the user group to which the user is assigned.

Further information on this may be available in your plant documentation

Layout

The configuration engineer can implement a simple or enhanced user view.

The two user views offer the same functions. They differ only in the display of information.

Simple user view

If you are not logged on to the HMI device, the only entry contained in the simple user view is "<ENTER>".

If you are logged on to the HMI device, the simple user view only displays the user name and user group.

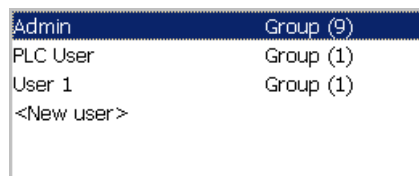

Admin	Group (9)
PLC User	Group (1)
User 1	Group (1)
<New user >	

Enhanced user view

The enhanced user view displays information about the users.

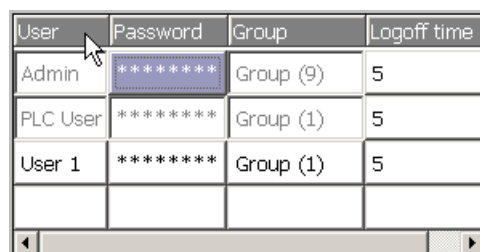

User	Password	Group	Logoff time
Admin	*****	Group (9)	5
PLC User	*****	Group (1)	5
User 1	*****	Group (1)	5

The enhanced user view contains the following columns:

- Users
- Password
- Group
- Logoff time

The passwords are encrypted by appear as asterisks.

8.12.3 User logon

Logon dialog

Use the logon dialog to log on to the security system of the HMI device. Enter your user name and password in the logon dialog.

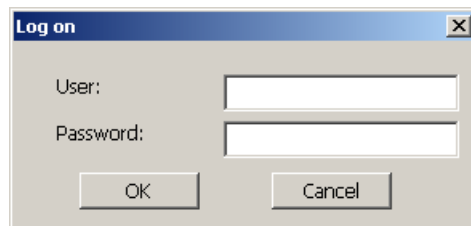

The logon dialog opens in the following cases:

- You are operating an operating element with password protection
- You are operating an operating element that was configured for displaying the logon dialog
- You activate the "<ENTER>" entry in the simple user view
- You activate a blank entry in the extended user view
- The logon dialog will be automatically displayed when the project is started, depending on the configuration

Further information on this may be available in your plant documentation.

Requirements

The logon dialog is open.

Procedure using the touch screen

Proceed as follows:

1. Enter the user name and password.
Touch the corresponding text box. The alphanumerical screen keyboard is displayed.
2. Select "OK" to confirm logon.

Procedure using the keys

Proceed as follows:

1. Using the key  select the "User" text box within the logon dialog.
2. Enter the user name using the system keys.

To enter letters, switch the numerical keypad to letter assignment using the key .

3. Using the key  select the "Password" text box.
4. Enter the password using the system keys.
5. Touch the "OK" button to confirm your entries.

Note

The user name is not case-sensitive.

The password is case-sensitive.

Result

After successful logon to the security system, you can execute password-protected functions on the HMI device for which you have authorizations.

If you enter a wrong password, an error message is displayed when an alarm window has been configured.

8.12.4 User logoff

Requirements

You have logged into the security system of the HMI device.

Procedure

You have the following options for logging off:

- You operate an operating element that was configured for logoff
- You will be logged off automatically if you are not operating the project and if the logoff time has been exceeded

You will also be automatically logged off if you enter an incorrect password.

Result

You are no longer logged into the project. In order to operate an operating element with password protection, you must first log on again.

8.12.5 Creating users

8.12.5.1 Creating users with touch operation

Requirements

You have opened a screen containing the user view.

You have user management authorization or you are the administrator.

NOTICE
The following characters cannot be used in passwords: <ul style="list-style-type: none">• Blank• Special characters * ? . % / \ ' "

Procedure for creating a user in the simple user view

Proceed as follows:

1. Touch the "<New User>" entry in the user view.

The following dialog opens:

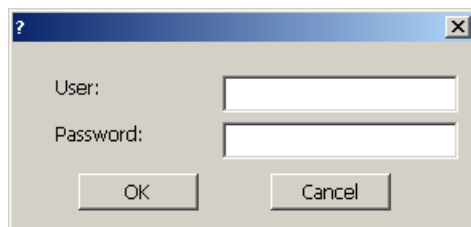

2. Enter the desired user name and password.



Touch the corresponding text box. The alphanumerical screen keyboard is displayed.

3. Touch the "OK" button.

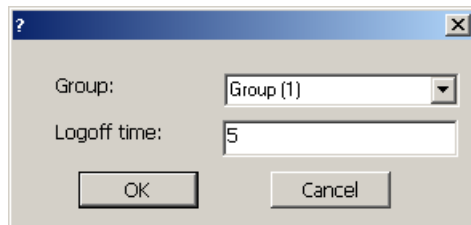
The following dialog opens:



4. Assign the user to a group.

In order to do so, open the "Group" drop down list box by means of the  button. Select  and  to scroll in the drop down list box.

5. Touch the required entry in the drop down list box.

The selected entry is then accepted as input.

6. Touch the text box "Logoff time". The screen keyboard is displayed.
7. Enter a value between 0 and 60 for the logoff time in minutes. The value 0 stands for "no automatic logoff."
8. Touch the "OK" button to confirm your entries.

Procedure for creating a user in the enhanced user view

Proceed as follows:

1. Touch the desired field in the blank line of the user view.
The appropriate screen keyboard is displayed.
2. Switch into input mode by means of the  key.
3. Enter the respective user data in the field:
 - Assign the user to one of the groups from the drop down list box.
 - Enter a value between 0 and 60 for the logoff time in minutes. The value 0 stands for "no automatic logoff."

Result

The new user is created.

8.12.5.2 Creating users with key operation

Requirements



You have opened a screen containing the user view.

You have user management authorization or you are the administrator.

NOTICE
The following characters cannot be used in passwords: <ul style="list-style-type: none">• Blank• Special characters * ? . % / \ ' "

Procedure for creating a user in the simple user view

Proceed as follows:

1. Select the user view using the key  or using the cursor keys.
2. Select the entry "<New user>" in the user view with the cursor keys and confirm with .



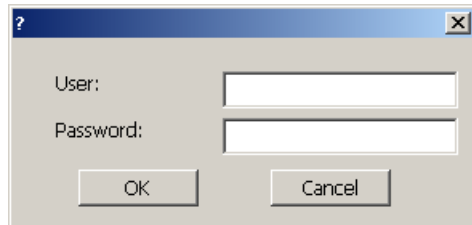



The following dialog opens:

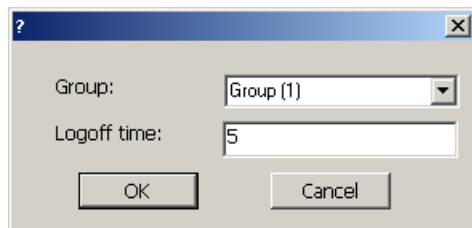

3. Enter the desired user name using the system keys.
4. Select the next text box with the  key and enter a password using the system keys.
5. Touch the "OK" button to confirm your entries.

The following dialog opens:













6. Select the "Group" selection box with .
7. Assign the user to a group.
 - Select  to open the drop down list box. The drop down list box opens.
 - Select the required entry using  or .
 - Confirm your entry by pressing the key .
8. Select the text box "Logoff time" with .
9. Enter the desired logoff time using the system keys.

Enter a value between 0 and 60 for the logoff time in minutes. The value 0 stands for "no automatic logoff."
10. Touch the "OK" button to confirm your entries.

Procedure for creating a user in the enhanced user view

Proceed as follows:

1. Select the user view with the  key via the configured tab order.
2. Select a blank line with the  or  keys.
3. Select the desired field in the blank line of the user view with the  or  keys.
4. Confirm your entry by pressing the key .
5. Enter the desired user data:
 - Enter the data using the system keyboard. To enter letters, switch the numerical keypad to letter assignment using the key .
 - Assign the user to one of the groups from the drop down list box. Open the drop down list box with the  key and select the desired entry with the  or  keys.
 - Enter a value between 0 and 60 for the logoff time in minutes. The value 0 stands for "no automatic logoff."
6. Confirm your entry by pressing the key .

Result

The new user is created.

8.12.6 Changing user data

8.12.6.1 Changing user data with touch operation

Requirements

You have opened a screen containing the user view.

Which data you are allowed to change depends on your authorization:

- You are an administrator or a user with user management authorization. In these cases you are allowed to change the data for all the users on the HMI device in the user view:
 - User name
 - Group assignment
 - Password
 - Logoff time
- You are a user without user management authorization. In this case you are only allowed to change your personal user data:
 - Password
 - Logoff time, if configured

Note

You can only change the logoff time and password for the "Admin" user.

You can only change the logoff time for the "PLC_User". This user is used for logging on via the PLC.

Procedure for changing user data in the simple user view

Proceed as follows:

1. In the user view, touch the user whose user data you want to change
2. When entering the data, use exactly the same procedure as for creating a user

Procedure for changing user data in the enhanced user view

Proceed as follows:

1. In the user view, touch the user whose user data you want to change
2. When entering the data, use exactly the same procedure as for creating a user

Result

The user data for the user is changed.

8.12.6.2 Changing user data with key operation

Requirements

You have opened a screen containing the user view.

Which data you are allowed to change depends on your authorization:

- You are an administrator or a user with user management authorization. In these cases you are allowed to change the data for all the users on the HMI device in the user view:
 - User name
 - Group assignment
 - Password
 - Logoff time
- You are a user without user management authorization. In this case you are only allowed to change your personal user data:
 - Password
 - Logoff time, if configured



Note

You can only change the logoff time and password for the "Admin" user.

You can only change the logoff time for the "PLC_User". This user is used for logging on via the PLC.



Procedure for changing user data in the simple user view

Proceed as follows:

1. Confirm your entry by pressing the key .
2. In the user view, use the cursor keys to select the user whose user data you want to change. Confirm your entry by pressing the key .
3. When entering the data, use exactly the same procedure as for creating a user.

Procedure for changing user data in the enhanced user view

Proceed as follows:

1. Confirm your entry by pressing the key .
2. Use the cursor keys to select the field in which you want to change data. Confirm your entry by pressing the key .
3. When entering the data, use exactly the same procedure as for creating a user

Result

The user data for the user is changed.

8.12.7 Deleting users

Requirements

You have opened a screen containing the user view.

To delete a user, you must be an administrator or have user management authorization.

Note

The "Admin" and "PLC_User" users exist by default. These users cannot be deleted.

Procedure

To delete a user, delete the user name entered.

Result

The user has been deleted and may no longer log onto the project.

8.13 Closing the project

Procedure

Proceed as follows:

1. Use the corresponding operating element object to close the project.
Wait for the Loader to open after you closed the project.
2. Switch off power to the HMI device.

Operating alarms

9.1 Overview

Alarms

Alarms indicate events and states on the HMI device which have occurred in the system, in the process or on the HMI device itself. A status is reported when it is received.

An alarm could trigger one of the following alarm events:

- Incoming
- Outgoing
- Acknowledge

The configuration engineer defines which alarms must be acknowledged by the user.

An alarm may contain the following information:

- Date
- Time
- Alarm text
- Location of fault
- State
- Alarm class
- Alarm number
- Alarm group
- Diagnostics capability

Alarm classes

Alarms are assigned to various alarm classes:

- Error
Alarms in this class must always be acknowledged. Error alarms normally indicate critical errors within the plant such as "Motor temperature too high"
 - Operation
Warning alarms usually indicate states of a plant such as "Motor switched on"
 - System
System alarms indicate states or events which occur on the HMI device
 - SIMATIC diagnostic alarms
SIMATIC diagnostic alarms show states and events of the SIMATIC S7 or SIMOTION PLCs
 - User-specific alarm classes
The properties of this alarm class must be defined in the configuration
- Further information on this may be available in your plant documentation.

Alarm groups

The configuration engineer can group alarms into alarm groups. When you acknowledge an individual alarm of an alarm group, you acknowledge all alarms which belong to the same alarm group.

Alarm buffer

The alarm events are stored in an internal buffer. The size of this alarm buffer depends on the HMI device type.

Alarm report

The configuration engineer can activate alarm reporting on the project. In this case, alarm events are output directly on the connected printer.

The configuration engineer can define whether each individual alarm is logged. An alarm of this type is printed when the alarm events "Incoming" and "Outgoing" occur.

If you want to print alarms of the "System" alarm class, you have to print the contents of the associated alarm buffer. For this case the configuration engineer has to configure an operating element for printing the alarm buffer.

Alarm log

Alarm events are stored in an alarm log, provided this log file is configured. The capacity of the log file is limited by the storage medium and system limits.

9.2 Detecting queued alarms

Introduction

You can recognize the presence of alarms which must be acknowledged by the following:

- For an HMI device with keys: The LED in the key  lights up.
- Depending on the configuration: An alarm indicator is displayed on screen.

The configuration determines whether an alarm has to be acknowledged or not. This is also defined by the alarm class which an alarm belongs to.

LED in the "ACK" key

On an HMI device with keys, an LED is integrated in the key . The LED is lit if there are alarms requiring acknowledgment which must still be acknowledged.

The LED goes out when you acknowledge all alarms requiring acknowledgment.

Alarm indicator

The alarm indicator is a graphic symbol indicating pending alarms or alarms requiring acknowledgment, depending on the configuration.



The alarm indicator flashes as long as alarms are pending for acknowledgment. The number displayed indicates the number of pending alarms. The configuration engineer can assign functions to be executed when the alarm indicator is operated.

Usually, the alarm indicator is only used for error alarms. Further information may be available in your plant documentation.

9.3 Message display

Displaying alarms

Alarms are displayed in the alarm view or in the alarm window on the HMI device.

Alarm view

Depending on the configuration, the alarm view is displayed as follows:

- As a single line. Alarm numbers and alarm texts are displayed as single lines
- As simple alarm view
- As enhanced alarm view

In the simple or enhanced alarm views the configuration engineer specifies the alarm information to be displayed.

Depending on the configuration, alarms from alarm logs are also displayed in the alarm view.

Simple alarm view

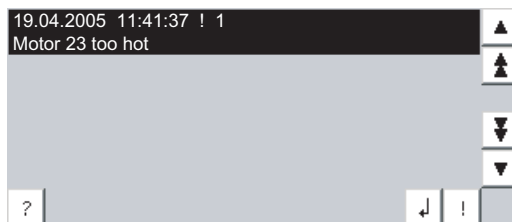



The buttons have the following functions:

Buttons	Functions
	Displaying infotext for an alarm.
	Process alarm.
	Acknowledge alarm.
	Select the next or previous alarm in the list.
	Scroll one page up or down.

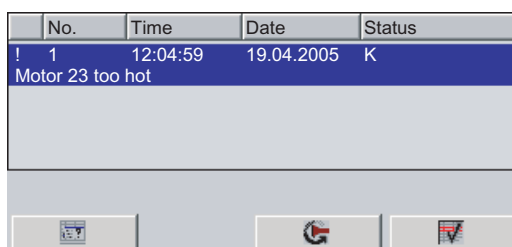
Enhanced alarm view



The buttons have the following functions:

Buttons	Functions
	Displaying infotext for an alarm.
	Process alarm.
	Acknowledging alarms.

Changing the column sequence and sorting in the enhanced alarm view

Depending on the configuration, you can change the column sequence and sorting order on HMI devices with touch operation.

- Change column sequence
 - Touch the column header which you wish to exchange with a different column header
 - Keeping the touch screen pressed, move the column heading to the column heading you wish to exchange it with
- Change sorting order

To change the sorting order of the alarms, touch the respective column header on the touch screen

Alarm class layout

The various alarm classes are identified in order to distinguish between them in the alarm view.

Icon	Alarm class
!	Error
Without a symbol	Operation
Symbol depending on the configuration	User-defined alarm classes
S7	SIMATIC or SIMOTION diagnostic alarms
\$	System

The configuration engineer can change the symbols for the alarm classes. Further information on this may be available in your plant documentation.

Alarm window

The alarm window is independent of the process screen. Depending on the configuration, the alarm window opens automatically as soon as a new alarm is pending for acknowledgment. The alarm window can be configured so that it only closes after all the alarms have been acknowledged.

The layout and the operation of the alarm window are the same as for the alarm view.

Further information on this may be available in your plant documentation.

9.4 Displaying infotexts

Displaying infotext

The configuration engineer can also provide infotext for alarms.

Procedure using the touch screen

Proceed as follows:

1. Touch the desired alarm in the alarm view or the alarm window.

The alarm is selected.

2. Touch the  button in the simple alarm view or  in the enhanced alarm view.

If configured, the infotext assigned to this alarm is displayed.

3. Close the screen for displaying the Infotext by means of the  button.

Procedure using the keys

Proceed as follows:

1. Select the desired alarm in the alarm view.

2. Press .

If configured, the infotext assigned to this alarm is displayed.

3. Close the infotext by pressing key .

9.5 Acknowledge alarm

Requirements

The alarm to be acknowledged is displayed in the alarm window or the alarm view.

Procedure using the touch screen

Proceed as follows:







1. Touch the desired alarm in the alarm view or the alarm window.

The alarm is selected.

2. Touch the  button in the simple alarm view or  in the enhanced alarm view.

Procedure using the keys

The alarm view and the alarm window have a tab sequence with which you can select operating elements and the last selected alarm using the keyboard.

1. Select the desired alarm view or alarm window with .
2. Select the desired alarm. Use the , ,  or  keys.
3. Press .

Alternative operation

Depending on the configuration, you can also acknowledge an alarm with a function key.

Result

The alarm is acknowledged. If the alarm belongs to an alarm group, all the alarms of the associated group are acknowledged.

More information on acknowledgment and on available alarm groups may be found in your plant documentation.

9.6 Editing alarms

Introduction

The configuration engineer can assign additional functions to each alarm. These functions are executed when the alarm is processed.

Note



When you edit an unacknowledged alarm, it is acknowledged automatically.

Requirements

The alarm to be edited is displayed in the alarm window or the alarm view.









Procedure using the touch screen

Proceed as follows:

1. Touch the desired alarm in the alarm view or the alarm window. The alarm is selected.
2. Touch the  button in the simple alarm view or  in the enhanced alarm view.

Procedure using the keys

Proceed as follows:

1. Select the desired alarm view or alarm window with .
2. Select the desired alarm. Use the , ,  or  keys.
3. Continue to press the key  until the button  is selected in the simple alarm view or  in the extended alarm view.
4. Confirm your entry by pressing the key .

Result

The system executes the additional functions of the alarm. Further information on this may be available in your plant documentation.

Operating recipes

10.1 Overview

Introduction

Recipes are used when different variants of a product are manufactured with the same process. In this case, the product variants differ in terms of their type and quantity of the components, but not in terms of the manufacturing process sequence. The configuration engineer can store the combination of each individual product variant in a recipe.

Field of application

Recipes can be used everywhere the same product components are used in variable combinations to create different product variants.

Examples:

- Beverage industry
- Food processing industry
- Pharmaceutical industry
- Paint industry
- Building materials industry
- Steel industry

10.2 Structure of a recipe

Recipes

The recipe collection for the production of a product family can be compared to a file cabinet. A recipe which is used to manufacture a product corresponds to a drawer in a file cabinet.

Example:

In a plant for producing fruit juice, recipes are required for different flavors. There is a recipe, for example, for the flavors orange, grape, apple and cherry.

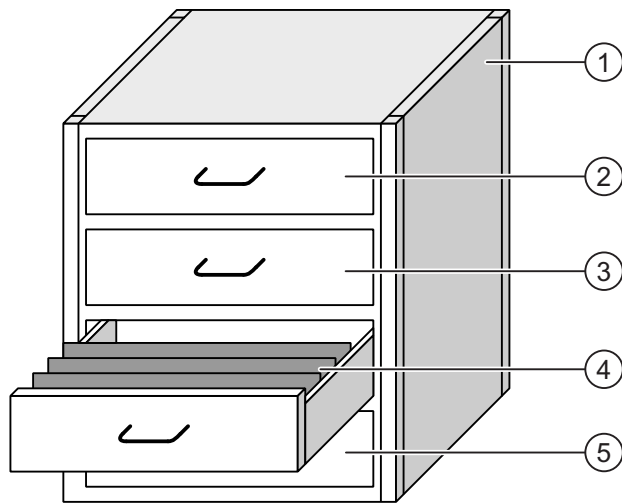

①	File cabinet	Recipe collection	Recipes for a fruit juice plant
②	Drawer	Recipe	Orange flavored drinks
③	Drawer	Recipe	Grape flavored drinks
④	Drawer	Recipe	Apple flavored drinks
⑤	Drawer	Recipe	Cherry flavored drinks

Recipe data records

The drawers of the file cabinet are filled with suspension folders. The suspension folders in the drawers represent records required for manufacturing various product variants.

Example:

Product variants of the flavor apple might be a soft drink, a juice or nectar, for example.

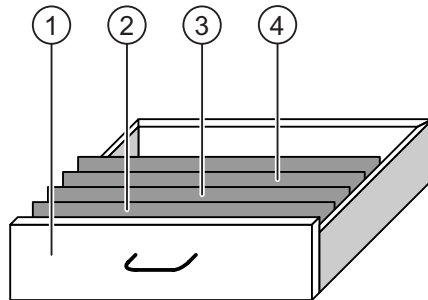

①	Drawer	Recipe	Product variants of apple flavored drinks
②	Suspension folder	Recipe data record	Apple drink
③	Suspension folder	Recipe data record	Apple nectar
④	Suspension folder	Recipe data record	Apple juice

Elements

In the figure showing the file cabinet, each suspension folder contains the same number of sheets. Each sheet in the suspension folder corresponds to an element of the recipe data record. All the records of a recipe contain the same elements. The records differ, however, in the value of the individual elements.

Example:

All drinks contain the same components: water, concentrate, sugar and flavoring. The records for soft drink, fruit juice or nectar differ, however, in the quantity of sugar used in production.

10.3 Recipes in the project

Overview

If recipes are used in a project, the following components interact:

- Recipe view / recipe screen

On the HMI device, recipes are displayed and edited in the recipe view or in a recipe screen.

- The recipe data records from the internal memory of the HMI device are displayed and edited in the recipe view.
- The values of the recipe tags are displayed and edited in the recipe screen

Depending on the configuration, the values displayed in the recipe view are synchronized with the values of recipe tags.

- HMI device recipe memory

Recipes are saved in the form of data records in the HMI device recipe memory.

The recipe data can also be saved in recipe tags.

- Recipe tags

The recipe tags contain recipe data. When you edit recipes in a recipe screen, the recipe values are stored in recipe tags. Depending on the configuration, the values of the recipe tags are exchanged with the PLC.

The recipe tags can be synchronized with the recipe data records so that the same values are saved in both.

- Memory card

The memory card is an external storage medium for recipe data records. The recipe data records are exported from the HMI device recipe memory and are saved on the memory card in a *.csv file. The records can be reimported from the memory card to the recipe memory.

Data flow

The following figure shows the data flow in a project with recipes.

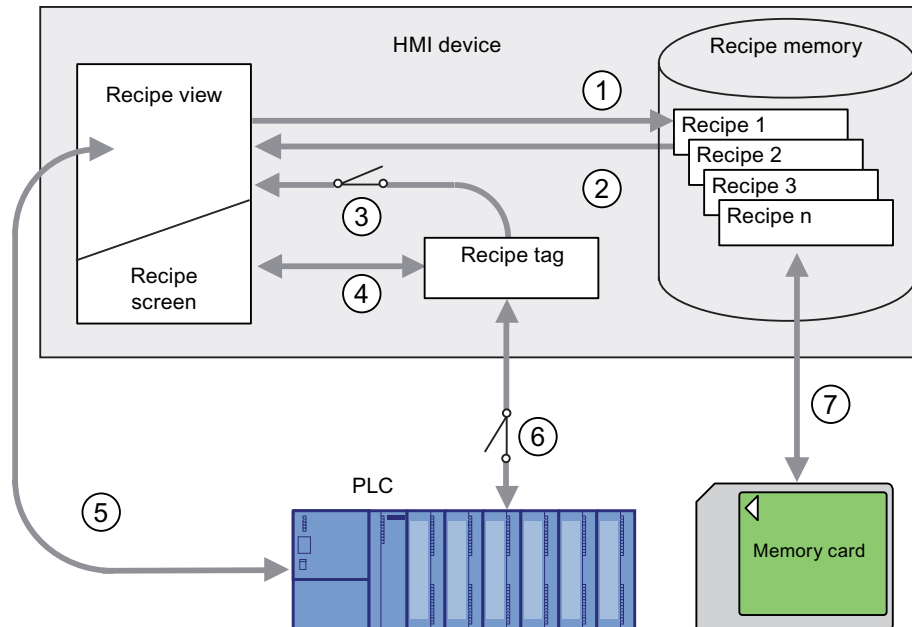

- ① Editing, saving or deleting a recipe data record
- ② Display recipe data record
- ③ Synchronize or do not synchronize recipe tags
- ④ Display and edit recipe tags in the recipe screen
- ⑤ Write records from the recipe view to the PLC or read records from the PLC and display them in the recipe view
- ⑥ Recipe tags are to the PLC online or offline
- ⑦ Export or import recipe data record to memory card

10.4 Recipe displays

Displaying recipes

You can display and edit recipes on the HMI device with a recipe view or recipe screen.

Recipe view

A recipe view is a screen object used to manage recipe data records. The recipe view shows recipe data records in tabular form.

Depending on the configuration, the recipe view is displayed as follows:

- As enhanced recipe view
- As simple recipe view

The configuration engineer also defines which operating elements are displayed in the recipe view.

Enhanced recipe view

The following figure shows an example of the enhanced recipe view.

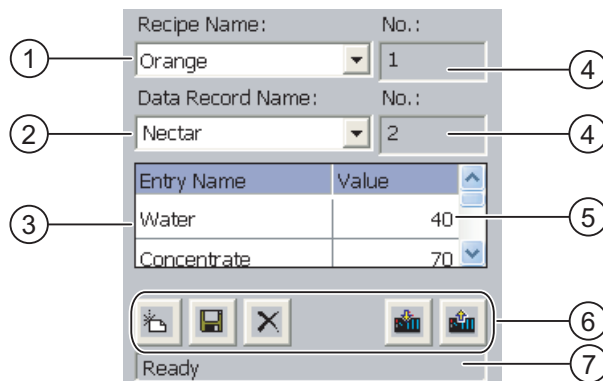

- ① Selection box for the recipe
- ② Selection box for the recipe data record
- ③ Element name
The element name designates a specific element in the recipe data record
- ④ Display field
This show the number of the selected recipe or the selected recipe data record
- ⑤ Value of the element
- ⑥ Buttons for editing a recipe data record
- ⑦ Status bar for display of the status messages

Simple recipe view

The simple recipe view consists of three areas:

- Recipe list
- Record list
- Element list

In the simple recipe view, each area is shown separately on the HMI device. Depending on the configuration, the simple recipe view starts with the recipe list or data record list.

The following figure shows an example of the record list.

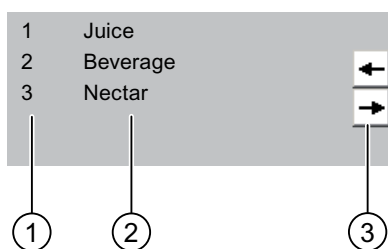

- ① Number of the recipe data record
- ② Recipe data records
- ③ Buttons for changing the displayed list and calling the menu

Display of values

NOTICE

Changing the recipe data record in the background

Applies to the processing of a recipe data record:

If values of the corresponding recipe data record are changed by a PLC job, the recipe view is not updated automatically.

To update the recipe view, reselect the respective recipe data record.

Recipe screen

A recipe screen allows the correlation between the plant and the recipe data to be displayed in graphic form. The configuration engineer combines I/O fields and screen objects to form a custom input screen. The configuration engineer can distribute the I/O fields of a recipe over several recipe screens, thus allowing recipe elements to be arranged by subject. The recipe screen can be operated using buttons configured accordingly.

The following figure shows an example of the recipe screen.

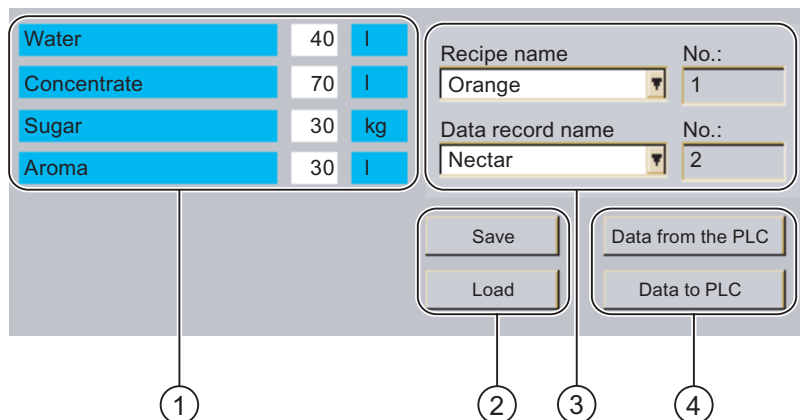

- ① Element name and associated values
The element name designates a specific element in the recipe data record
- ② Buttons for editing a recipe data record
- ③ Modified recipe view
- ④ Buttons for transferring recipe data

The values displayed or entered in the recipe screen are saved in recipe tags. The recipe values are exchanged with the PLC immediately or later via these tags.

A configured recipe view can itself be a component of a recipe screen. You must synchronize the tags in order to synchronize data between the tags of the recipe screen and the recipe data records displayed in the recipe view. Synchronization of tags is only possible in the enhanced recipe view.

Further information on this may be available in your plant documentation.

10.5 Recipe values in the HMI device and the PLC

Introduction

You can change the values of a recipe on the HMI device and therefore influence the manufacturing process or a machine.

Depending on the configuration, the recipe values are displayed, edited and saved in different ways:

- If you are editing recipes with a recipe view in your project, the values are saved in recipe data records
- If you are editing recipes in a recipe screen in your project, the values are saved in recipe tags

Differences may occur between the display values in the recipe view and the values saved in the associated tags in an ongoing project when you edit recipes with a recipe view and in a recipe screen. To prevent this, the recipe data record values must be synchronized with the values of the recipe tags.

You have however the option to perform synchronization operations at any time. Synchronization only takes place if the configuration engineer has activated the respective settings for a recipe.

Note

Recipe tags can only be synchronized in the enhanced recipe view.

Synchronizing recipe tags

Synchronization of the recipe tags depends on the configuration:

- Automatic synchronization:

The values of the recipe view are synchronized with the associated recipe tags. In this case, changes to values in the recipe view have an immediate effect on the values of the associated recipe tags. The values are only synchronized, when an operating element that is outside the recipe view is operated.

- Synchronization by the user:

The values of the recipe view and the associated recipe tags are not synchronized automatically. The configuration engineer has assigned the same function to the  button or a different operating element in the recipe view. The recipe tags and the recipe view are only synchronized when you operate the buttons or the appropriate operating element.

Recipe tags online / offline

The configuration engineer can configure a recipe so that changes to the values of the recipe tags do not have an immediate effect on the current process.

Synchronization of the recipe values between the HMI device and the PLC depends on whether the configuration engineer has selected the settings "Tags online" or the setting "Tags offline" for a recipe.

- "Tags online":

This setting has the following effect:

- When you change recipe values in the recipe screen, these changes are applied immediately by the PLC and immediately influence the process
- If recipe values are changed in the PLC, the changed values are displayed immediately in the recipe screen

- "Tags offline":

With this setting, changed recipe values are not synchronized immediately between the HMI device and the PLC

In this case, the configuration engineer must configure operating elements for transferring the values to the PLC or reading them from the PLC in a recipe screen. The recipe values are only synchronized between HMI device and PLC when you operate the appropriate operating element

10.6 Operating the recipe view

10.6.1 Overview











Operation

The recipe view can be operated as follows:

- Enter values for the recipe elements
- Create recipe data records
- Save recipe data records or save them under a new name
- Delete recipe data records
- Synchronize values of the recipe view with the associated recipe tags
- Transfer recipe data records from the PLC and to the PLC

Operating elements of the recipe view

The following table shows the operating elements of the recipe view.

Buttons	Key combination	Functions
	CTRL + 	Creates a new recipe data record. If a start value is configured, it is shown in the text box.
	CTRL + ENTER	Saves the displayed values of the recipe data record. The storage location is predefined by the project.
	CTRL + *	The recipe data record is saved under a different name irrespective of the recipe view. A dialog box opens in which the name is entered.
	CTRL + 	The displayed recipe data record is deleted.
	CTRL + =	The values of the recipe view are synchronized with the associated recipe tags. The values changed during editing are written to the associated recipe tags. Subsequently all the values of the tags are read out and updated in the table.
	CTRL + 	The recipe values from the PLC are displayed in the recipe view.
	CTRL + 	The values of the set recipe data record displayed in the recipe view are transferred to the PLC.

Operating the recipe screen

You operate the recipes in a recipe screen with the operating elements provided by the configuration engineer.

Further information on this may be available in your plant documentation.

10.6.2 Creating a recipe data record

Introduction

You create a new recipe data record by modifying an existing record. You then save the modified data record under a new name.

Requirements

A screen with a recipe view is displayed.

Procedure using the touch screen

Proceed as follows:

1. If the recipe view contains several recipes: Select the recipe for which you want to create a new recipe data record.

2. Touch .

A new recipe data record with the next available number is created.

If you change the new data record number to an existing data record number, the existing data record is overwritten.

3. Enter values for the elements of the data record.

The elements of the recipe data record can be assigned default values depending on the configuration.

4. Touch .

5. Enter a name for the data record.

The data record is saved under the new name.

If the recipe data record already exists, a dialog is opened. In this dialog, specify whether the existing data record is to be overwritten.

Procedure using the keys

Proceed as follows:

1. If the recipe view contains several recipes: Select the recipe for which you want to create a new recipe data record.

2. Press  + .

A new recipe data record with the next available number is created.

If you change the new data record number to an existing data record number, the existing data record is overwritten.

3. Enter values for the elements of the data record.

The elements of the recipe data record can be assigned default values depending on the configuration.

4. Press  + .

5. Enter a name for the data record.

6. Confirm your entry.

The data record is saved under the new name.

If the recipe data record already exists, a dialog is opened. In this dialog, specify whether the existing data record is to be overwritten.

Result

The new recipe data record is saved to the selected recipe.

10.6.3 Editing a recipe data record

Introduction

Edit the values of the recipe data records and save them in a recipe view.

Synchronization with the PLC

If you want to display the current recipe values from the PLC in the recipe view, you first have to read the current values from the PLC with .

The values changed in the recipe view only become effective when the amended data record is transferred to the PLC by means of the  button.

Requirements

A screen with a recipe view is displayed.

Procedure using the touch screen

Proceed as follows:



1. If the recipe view contains several recipes: Select the recipe which contains the desired recipe data record.
2. Select the recipe data record you want to change.
3. Change the data record as required.
4. Save your changes by means of the  button.



If you want to save the recipe data record under a different name, touch the  key.

5. The recipe data record is saved.

Procedure using the keys

Proceed as follows:

1. If the recipe view contains several recipes: Select the recipe which contains the desired recipe data record.
2. Select the recipe data record you want to change.
3. Change the data record as required.
4. Save your changes with  + .

If you want to save the recipe data record under a different name, press  + .

The recipe data record is saved.

Result

The edited recipe data record has now been saved in the selected recipe.

10.6.4 Deleting a recipe data record

Introduction

You can delete all the data records of a recipe which are not required.

Requirements

A screen with a recipe view is displayed.



Procedure using the touch screen

Proceed as follows:

1. If the recipe view contains several recipes: Select the recipe which contains the desired recipe data record.
2. Select the recipe data record you want to delete.
3. Touch .

Procedure using the keys

Proceed as follows:

1. If the recipe view contains several recipes: Select the recipe which contains the desired recipe data record.
2. Select the recipe data record you want to delete.
3. Press  + .

Result

The recipe data record is deleted.

10.6.5 Synchronizing tags

Introduction

The values of the recipe elements can be saved to recipe tags, depending on the configuration.

Differences may occur between the display values in the recipe view and the actual values of tags in an ongoing project. Synchronize the tags to equalize such differences.

Synchronization always includes all the variables which belong to a recipe data record.

NOTICE
Changed tag name
Tags and the value of the recipe data record cannot be assigned to each other if the tag name of the tag to be synchronized has been changed. The tags in question are not synchronized.

Note

Recipe tags can only be synchronized in the enhanced recipe view.

Requirements

A screen with a recipe view is displayed.



Procedure using the touch screen

Proceed as follows:

1. If the recipe view contains several recipes: Select the recipe which contains the desired recipe data record.
2. Select the recipe data record you want to synchronize.
3. Touch .

Procedure using the keys

Proceed as follows:

1. If the recipe view contains several recipes: Select the recipe which contains the desired recipe data record.
2. Select the recipe data record you want to synchronize.
3. Press  + .

Result

The elements of the recipe data record are synchronized with the recipe tags.

If the values of the recipe view and the tag do not match, the more current value is accepted.

10.6.6 Reading a recipe data record from the PLC

Introduction

In the current project, the values which are also stored in the recipes in the HMI device can be changed directly in the plant. This is the case, for example, if a valve was opened further directly at the plant than is stored in the recipe. The values of the recipe data records saved in the HMI device possibly no longer match the values in the PLC.

To synchronize the recipe values, read the values from the PLC and display them in the recipe view.

Requirements

A screen with a recipe view is displayed.

Procedure using the touch screen

Proceed as follows:

1. If the recipe view contains several recipes: Select the recipe which contains the desired recipe data record.
2. Select the recipe data record to which you want to apply the values from the PLC.

3. Touch .

The values are read from the PLC.

4. If you want to store the displayed values in the HMI device, touch the  button.



Procedure using the keys

Proceed as follows:

1. If the recipe view contains several recipes: Select the recipe which contains the desired recipe data record.
2. Select the recipe data record to which you want to apply the values from the PLC.

3. Press  + .

The values are read from the PLC.

4. If you want to store the displayed values in the HMI device, press the keys  + .

Result

The values were read from the PLC, displayed on the HMI device and saved to the selected recipe data record.

10.6.7 Transferring a recipe data record to the PLC

Introduction

In order for an edited recipe data record to take effect in the process, you must transfer the values to the PLC.

The display values in the recipe view are always transferred to the PLC.

Requirements

A screen with a recipe view is displayed.



Procedure using the touch screen

Proceed as follows:

1. If the recipe view contains several recipes: Select the recipe which contains the desired recipe data record.
2. Select the recipe data record whose values you want to transfer to the PLC.
3. Touch .

Procedure using the keys

Proceed as follows:

1. If the recipe view contains several recipes: Select the recipe which contains the desired recipe data record.
2. Select the recipe data record whose values you want to transfer to the PLC.
3. Press  + .

Result

The display values in the recipe view were transferred to the PLC and take effect in the process.

10.7 Operating the simple recipe view

10.7.1 Overview

Introduction

The simple recipe view consists of three areas:

- Recipe list
- Record list
- Element list

You can use the context menu to operate each of these display areas.

Operation





The simple recipe view can be operated as follows:

- Enter values for the recipe elements
- Create recipe data records
- Save recipe data records or save them under a new name
- Delete recipe data records
- Transfer recipe data records from the PLC and to the PLC



Operating elements of the simple recipe view

Toggle between the display areas and the context menus to operate the simple recipe views.

The following table shows the operation of the display area.

Touch operation	Key control	Functions
Touching an entry		The next lower display area opens.
		The next higher display area opens.
		The context menu of the display area opens.

The following table shows the operation of the context menu.

Touch operation	Key control	Functions
		The menu is closed. The display area opens.
Touch the menu command	Input of the number of the menu command	The menu command is executed.



Context menus of the simple recipe view

A number is assigned to each menu command which you can use to call the menu command with key control.

With touch operation, touch the menu command to execute it.

Some menu functions can also be called directly in the lists of the simple recipe view using the keys.

- Recipe list

No.	Menu command	Key combination	Functions
0	New		A new recipe data record is created for the selected recipe. If a start value is configured, it is shown in the text box.
1	Displaying infotext		The infotext configured for the simple recipe view is displayed.
2	Open		The record list of the selected recipe opens.

- Record list

No.	Menu command	Key combination	Functions
0	New		A new recipe data record is created for the selected recipe. If a start value is configured, it is shown in the text box.
1	Delete		The selected record is deleted.
2	Save as		The selected record is saved under a different name irrespective of the simple recipe view. A dialog box opens in which the name is entered.
3	Rename		The selected record is renamed. A dialog box opens in which the name is entered.



- Element list

No.	Menu command	Key combination	Functions
0	Save		The selected record is renamed.
1	To PLC		The display values of the selected record are transferred from the HMI device to the PLC.
2	From PLC		The recipe values from the PLC are displayed on the HMI device in the recipe view.
3	Save as		The selected record is renamed. A dialog box opens in which the name is entered.

Touch operation of the menu

Touch the desired menu command. The command is executed.

Key control of the menu

Select the required entry using  or . Press .

Alternatively, press the numerical key with the number of the desired menu command.

The command is executed.

Operating the recipe screen

You operate the recipes in a recipe screen with the operating elements provided by the configuration engineer.

Further information on this may be available in your plant documentation.

10.7.2 Creating a recipe data record

Introduction

Create a new recipe data record in the recipe list or in the record list. Then enter the values for the new record in the element list and save the record.

Requirements

A screen with a simple recipe view is displayed.

Procedure

Proceed as follows:

1. If the recipe list contains several recipes: Select the recipe for which you want to create a new recipe data record.
2. Open the recipe list menu.
3. Select the menu command "0 New".

A new record is created.

The element list of the new record opens.

4. Enter values for the elements of the data record.
The tags of the record can be assigned default values depending on the configuration.
5. Open the element list menu and select the menu command "0 Save".
6. Enter a name for the new record.
7. Confirm your entries.

If you change the new data record number to an existing data record number, the existing data record is overwritten.

Result

The new recipe data record is saved to the selected recipe.

10.7.3 Editing a recipe data record

Introduction

Edit the values of the recipe data records in a simple recipe view.

Synchronization with the PLC

If you want to display the current recipe values from the PLC in the simple recipe view, you first have to read the current values from the PLC with the menu command "2 from PLC" in the element list.

The values changed in the recipe view only take effect in the PLC when you transfer the edited data record to the PLC with the menu command "1 to PLC".

Requirements

A screen with a simple recipe view is displayed.

Procedure

Proceed as follows:

1. If the recipe list contains several recipes: Select the recipe which contains the desired recipe data record.
2. Open the data record list.
3. Select the recipe data record you want to change.
4. Open the element list.
5. Change the values of the records as required.
6. Save your changes with the menu command "0 Save".

The recipe data record is saved.

Result

The edited recipe data record has now been saved in the selected recipe.

10.7.4 Deleting a recipe data record

Introduction

You can delete all the data records which are not required.

Requirements

A screen with a simple recipe view is displayed.

Procedure using the touch screen

Proceed as follows:

1. If the recipe list contains several recipes: Select the recipe which contains the desired recipe data record.
2. Open the data record list.
3. Select the data record you want to delete.
4. Open the menu.
5. Select the menu command "1 Delete".

Procedure using the keys

Proceed as follows:

1. If the recipe list contains several recipes: Select the recipe which contains the desired recipe data record.
2. Open the data record list.
3. Select the data record you want to delete.
4. Press .

Result

The data record is deleted.

10.7.5 Reading a recipe data record from the PLC

Introduction

The values of recipe elements are exchanged with the PLC via tags.

In the current project, the values which are also stored in the recipes in the HMI device can be changed directly in the plant. This is the case, for example, if a valve was opened further directly at the plant than is stored in the recipe. The values of the tags on the HMI device possibly no longer match the values in the PLC.

To synchronize the recipe values, read the values from the PLC and display them in the recipe view.

Requirements

A screen with a simple recipe view is displayed.

Procedure

Proceed as follows:

1. If the recipe list contains several recipes: Select the recipe which contains the desired recipe data record.
2. Select the element list of the recipe data record to which you want to apply the values from the PLC.
3. Open the menu.
4. Select the menu command "2 from PLC".
The values are read from the PLC.
5. If you want to save the display values in the HMI device, select the menu command "0 Save".

Result

The values were read from the PLC, displayed on the HMI device and saved to the selected recipe data record.

10.7.6 Transferring a recipe data record to the PLC

Introduction

In order for an edited recipe data record to take effect in the process, you must transfer the values to the PLC.

The display values in the recipe view are always transferred to the PLC.

Requirements

A screen with a simple recipe view is displayed.

Procedure

Proceed as follows:

1. If the recipe list contains several recipes: Select the recipe which contains the desired recipe data record.
2. Select the element list of the recipe data record whose values you want to transfer to the PLC.
3. Open the menu.
4. Select the menu command "1 To PLC".

Result

The values of the recipe data record were transferred to the PLC and take effect in the process.

10.8 Importing a recipe data record

Introduction

You can import values from a CSV file to a recipe data record, depending on the configuration.

Requirements

- An operating element with the function "Import data record" has been configured, for example a button
- A screen with a recipe view is displayed.

Procedure

Proceed as follows:

1. If the recipe view contains several recipes: Select the recipe which contains the recipe data record to be imported.
2. Operate the operating element with the function "Import data record".

The record is imported from an external data medium as a CSV file and then displayed in the recipe view after import.

Result

The imported recipe data record is saved on the HMI device.

Deviating structure

If the structure of the CSV file differs from the structure of the recipe, deviations are handled as follows:

- Any additional values in the CSV file will be rejected
- The system applies the configured default value to the recipe data record if the CSV file contains an insufficient number of values
- If the CSV file contains values of the wrong data type, the configured default value is set in the recipe data record

Example:

The imported CSV file contains values that were entered as floating point numbers.

However, the corresponding tag expects an integer value. In this case, the system discards the imported value and uses the configured default.

10.9 Exporting a recipe data record

Introduction

You can export one or more recipe data records to a CSV file, depending on the configuration. After export, the values in the recipe data record can be further processed in a spreadsheet program such as MS Excel. The degree to which you can influence the export depends on the configuration.

Requirements

- A screen with a recipe view is displayed.
- An operating element with the function "Export record" has been configured.
- The following tags are configured equally in the recipe view and for the "Export record" operating element:
 - Recipe number
 - Data record number

Procedure

Proceed as follows:

1. If the recipe view contains several recipes: Select the recipe which contains the desired recipe data record.
2. Select the recipe data record you want to export.
3. Operate the operating element which was configured for export, for example the "Export data record" button.

The data record is exported as a CSV file to an external data medium.

Further information on this may be available in your plant documentation.

Result

The recipe data record is exported.

10.10 Examples

10.10.1 Entering a recipe data record

Introduction

You would like to enter production data on the HMI device without interrupting the process in the machine or plant. For this reason, the production data should not be transferred to the PLC.

Procedure

Proceed as follows:

1. Call the recipe view or a recipe screen.
2. Select the desired recipe data record.
3. Enter the values of the elements.
4. Save the recipe data record.

The recipe data record is saved in the internal memory of the HMI device.

The following figure shows the data flow schematically.

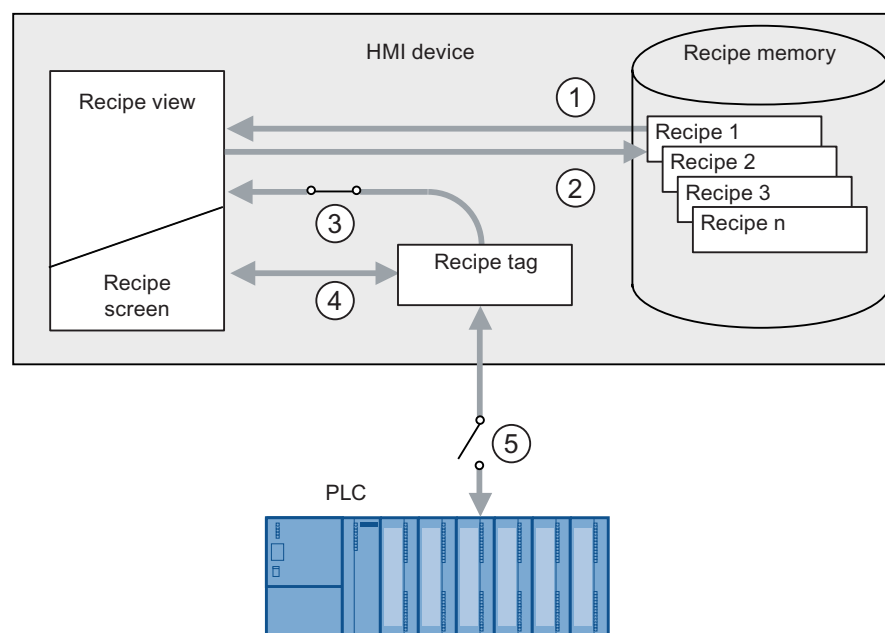

- ① Display recipe data record
- ② Save recipe data record
- ③ Tags are synchronized
- ④ Display and edit recipe tags in the recipe screen
- ⑤ Tags are offline

10.10.2 Manual production sequence

Introduction

You request the production data of different workpieces from the PLC and display this data on the screen of the HMI device for inspection. You want to correct the transferred production data in the recipe view or the recipe screen if necessary.

Procedure

A scanner connected to the PLC reads the barcode of a workpiece. The barcode names correspond to the names in the recipe data record. Based on the barcode name, the PLC can read the required recipe data record. The recipe data record is displayed for inspection on the HMI device. You can now edit and save the recipe data record. Then transfer the edited recipe data record to the PLC again.

The following figure shows the data flow schematically.

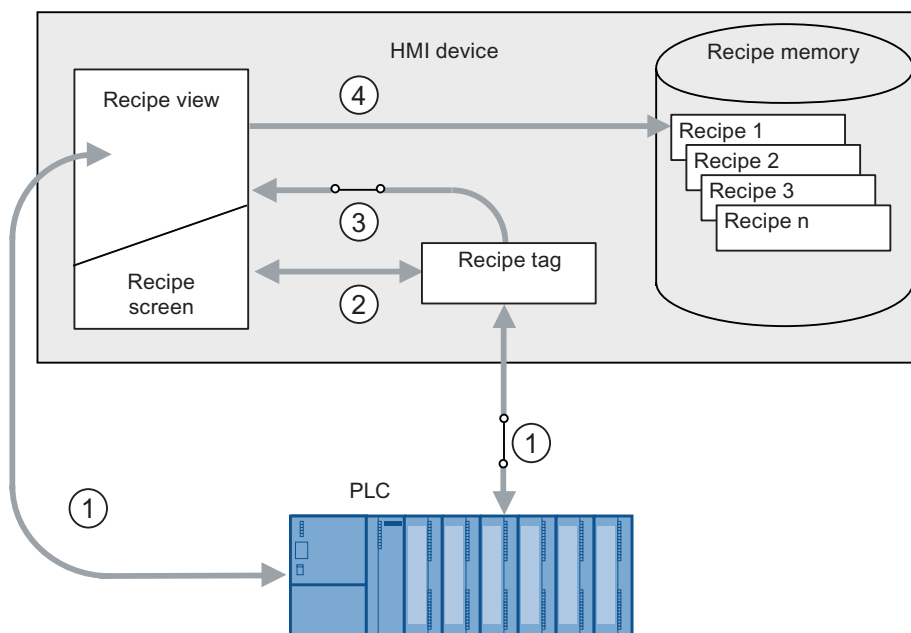

- ① The recipe data record is read from the PLC and written to the PLC again following changes
- ② Display and edit recipe tags in the recipe screen
- ③ Tags are synchronized
- ④ Recipe data records are saved in the recipe memory of the HMI device

Maintenance and care

11.1 Maintaining and caring for the touch screen and keyboard overlay

Introduction

The HMI device is designed for maintenance-free operation. The touch screen and keyboard overlay should nevertheless be cleaned regularly.

Requirement

- Damp cleaning cloth
- Washing up liquid or foaming screen cleaning agent

Procedure

NOTICE**Unintentional response**

If you clean the touch screen or an HMI device with a keyboard overlay when it is switched on, you may cause maloperations.

Switch off the HMI device, or if the HMI device is running, clean the touch screen only in a blocked state! Note that the touch screen block automatically ends after 15 seconds.

Damage caused by unauthorized cleaning products

Using compressed air or steam cleaners, or aggressive solutions or scouring agents will damage the HMI device.

Do not clean the HMI device with compressed air or steam jet blowers. Do not use aggressive solvents or scouring powder.

Proceed as follows:

1. Switch off the HMI device or block the touch screen.
2. Spray the cleaning solution onto a cleaning cloth.
Do not spray directly onto the HMI device.
3. Clean the HMI device.
When cleaning the display wipe from the screen edge inwards.

11.2 Clean screen on MP 377 Touch

Introduction

The HMI touch screen can be cleaned when it is switched on and a project is running. An operating element must be available in the project that can be used to call the "clean" screen. Once the clean screen is activated, touch screen operation is locked for a configured period of time. The time the touch screen is locked can be set between 5 and 30 seconds. The time remaining for the lockout is indicated by a progress bar.

NOTICE

Unintentional responses

When cleaning the touch screen, an unintentional response in the controller can be triggered by touching keys.
--

Always open the clean screen or switch off the HMI device before you clean the touch screen while the system is running!
--

Once the period for the clean screen has passed, operations are again possible. Avoid data inadvertent operations.
--

Cannot be operated when the clean screen is active

When the clean screen is active, operations on the HMI device are not possible.

Wait for the period for the clean screen to lapse. Then you can operate the plant again with the HMI device.
--

11.3 Spare parts and repairs

Repairs

In case of repair, the HMI device must be shipped to the Return Center in Fürth. Repairs may only be carried out at the Return Center in Fürth.

Depending on the work necessary to repair the device, the Center may decide to give you a credit note. A credit note is only granted when the sender orders a new HMI device.

The address is:

Siemens AG
Industry Sector
Returns Center
Siemensstr. 2
90766 Fürth
Germany

Spare parts

You can find spare parts and accessories for the HMI devices in the section Accessories (Page 26).

Technical specifications

12.1 Dimension drawings

12.1.1 Dimension drawings of the MP 377 12" Touch

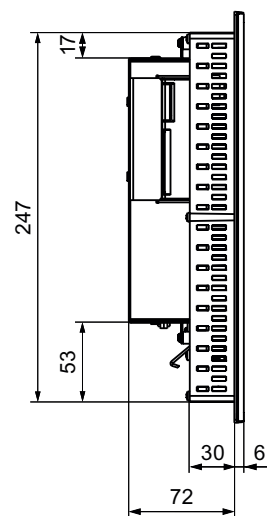
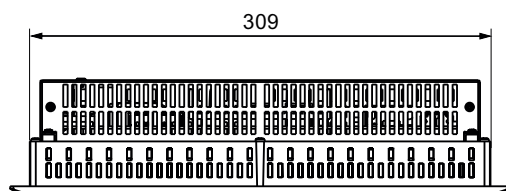
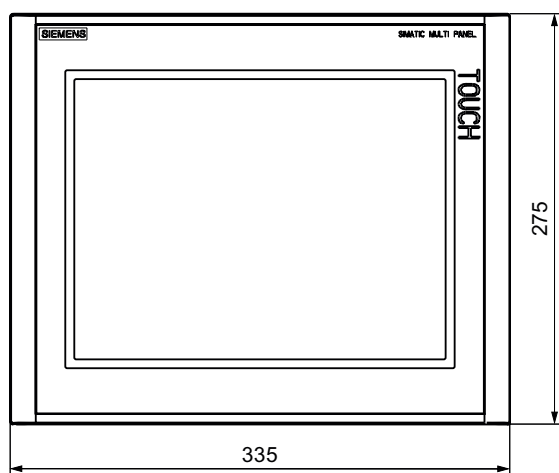

All dimensions in mm.
Tolerance ± 1 mm

12.1.2 Dimension drawings of the MP 377 12" Key

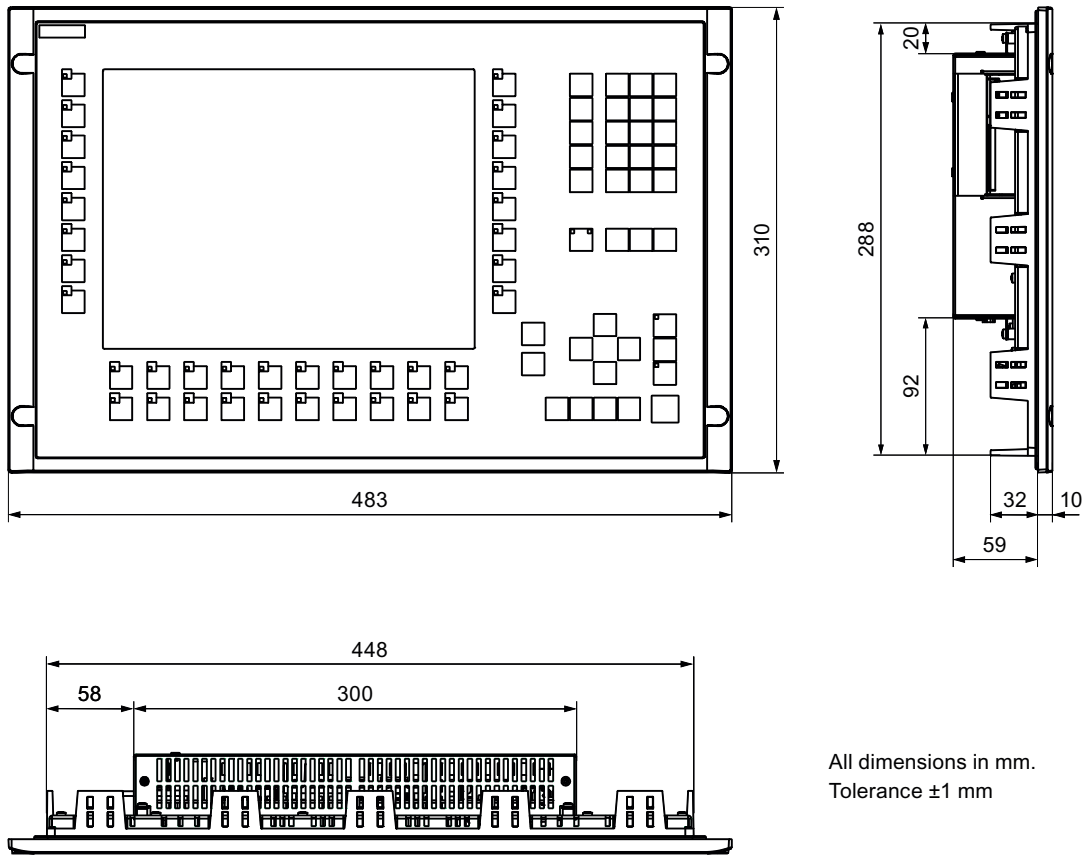

All dimensions in mm.
Tolerance ± 1 mm

12.1.3 Dimension drawings of the MP 377 15" Touch

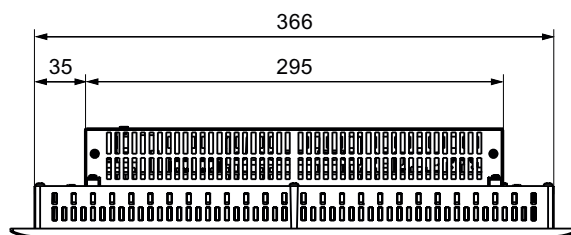
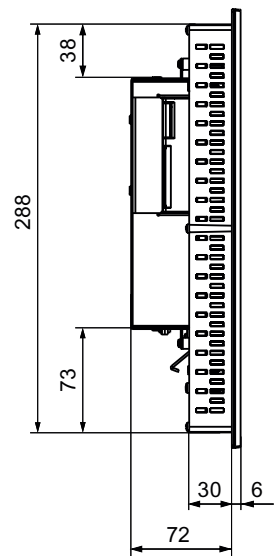
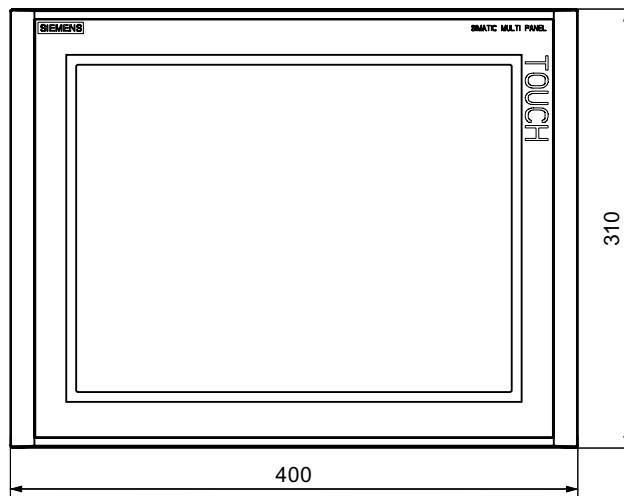

All dimensions in mm.
Tolerance ± 1 mm

12.1.4 Dimension drawings of the MP 377 19" Touch

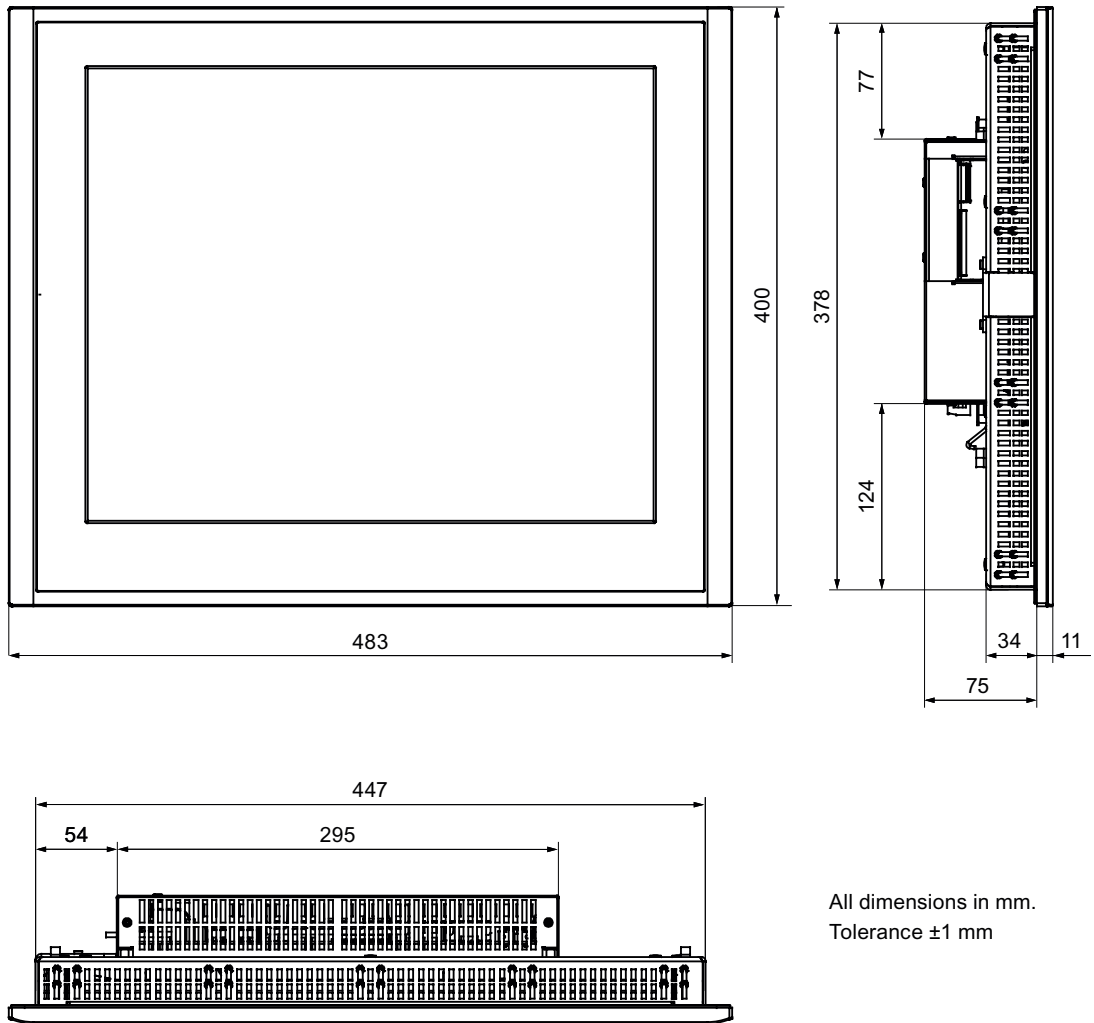

All dimensions in mm.
Tolerance ± 1 mm

12.1.5 Dimension drawings of the MP 377 PRO 15" Touch

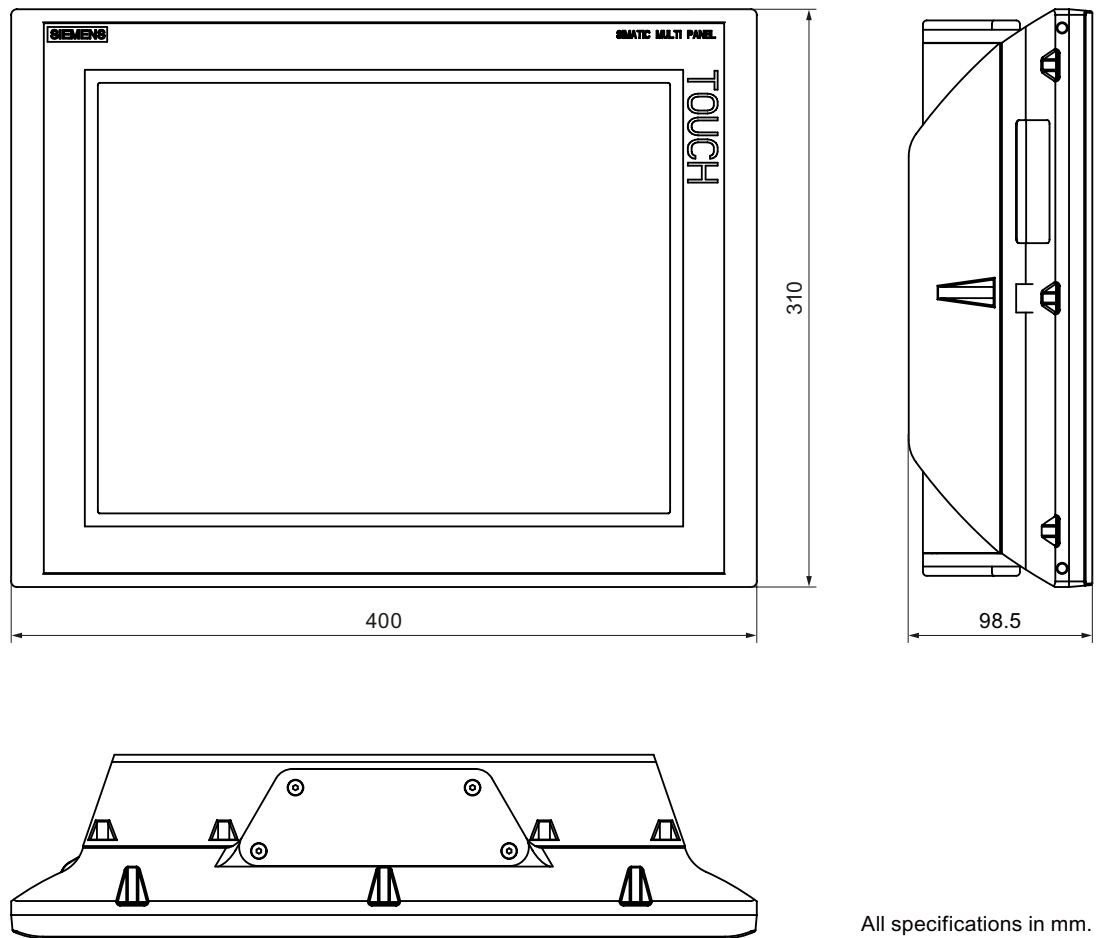

All specifications in mm.

12.2 Specifications

HMI device

	MP 377 12" Touch	MP 377 12" Key	MP 377 15" Touch	MP 377 PRO 15" Touch	MP 377 19" Touch
Weight without packaging	3.75 kg	5.41 kg	4.69 kg	Approx. 7.3 kg, with basic adapter approx. 7.7 kg	7.65 kg

Display

	MP 377 12" Touch	MP 377 12" Key	MP 377 15" Touch	MP 377 PRO 15" Touch	MP 377 19" Touch
Type	LCD TFT				
Display area, active	246 mm x 184.5 mm (12.1")		304.1 mm x 228.1 mm (15")		376.3 mm x 301.1 mm (19")
Resolution	800 x 600 pixels		1 024 x 768 pixels		1 280 x 1 024 pixels
Colors, displayable	64 K				
Brightness control	Yes				
Backlighting	CCFL				
Half brightness life time, typical	50 000 h				
Pixel error class according to DIN EN ISO 13406-2	II				

Input device

	MP 377 12" Touch	MP 377 12" Key	MP 377 15" Touch	MP 377 PRO 15" Touch	MP 377 19" Touch
Type	Touch screen, analog, resistive	Keyboard	Touch screen, analog, resistive		

Memory

	MP 377 12" Touch	MP 377 12" Key	MP 377 15" Touch	MP 377 PRO 15" Touch	MP 377 19" Touch
Application memory	12 MB				

Interfaces

	MP 377 12" Touch	MP 377 12" Key	MP 377 15" Touch	MP 377 PRO 15" Touch	MP 377 19" Touch
1 x RS 422/RS 485	Max. 12 Mbps, applies to DP operations				
2 x USB 2.0	USB host Conforms to USB standard 2 (supporting low-speed and full-speed USB devices), maximum load 500 mA				
2 x Ethernet	RJ45 10/100 Mbps				
Audio	Line out				

Supply voltage

	MP 377 12" Touch	MP 377 12" Key	MP 377 15" Touch	MP 377 PRO 15" Touch	MP 377 19" Touch
Rated voltage	+24 V DC				
Voltage range, permissible	19.2 to 28.8 V (-20%, +20%)				
Transients, maximum permissible	35 V (500 ms)				
Time between two transients, minimum	50 s				
Current consumption					
<ul style="list-style-type: none"> • Typical • Constant current, maximum • Power on current surge I²t 	Approx. 1 300 mA Approx. 1 800 mA Approx. 4 A ² s		Approx. 1 700 mA Approx. 2 500 mA Approx. 4 A ² s		Approx. 2 200 mA Approx. 3 100 mA Approx. 4 A ² s
Fuse, internal	Electronic				

Miscellaneous

	MP 377 12" Touch	MP 377 12" Key	MP 377 15" Touch	MP 377 PRO 15" Touch	MP 377 19" Touch
Realtime clock, buffered ¹⁾	Yes				
Loudspeaker	Onboard				
Magnetic field intensity	50/60 Hz; 100 A/m RMS				

¹⁾ Bridging time of the buffering - approx. 6 weeks.

12.3 Bit assignment of the direct keys

The following figures show the assignment of the keys and LEDs to the bytes in the PLC process image.

Further information may be available in your plant documentation.

Note

Do not use the LED bits "ACK", "A-Z", and "HELP" when a project is running on the HMI device.

Bit assignment of the direct keys for the MP 377 12" Key

Button bits								Byte	LED bits							
7	6	5	4	3	2	1	0		7	6	5	4	3	2	1	0
S8	S7	S6	S5	S4	S3	S2	S1	"n"	S8	S7	S6	S5	S4	S3	S2	S1
S16	S15	S14	S13	S12	S11	S10	S9	n + 1	S16	S15	S14	S13	S12	S11	S10	S9
F8	F7	F6	F5	F4	F3	F2	F1	n + 2	F8	F7	F6	F5	F4	F3	F2	F1
F16	F15	F14	F13	F12	F11	F10	F9	n + 3	F16	F15	F14	F13	F12	F11	F10	F9
ACK	ALT	CTRL	SHIFT	F20	F19	F18	F17	n + 4	ACK	A-Z ¹⁾	A-Z ²⁾	INFO	F20	F19	F18	F17

- 1) Left LED
- 2) Right LED

Bit assignment of the direct keys for the MP 377 12" Touch, MP 377 15" Touch and MP 377 19" Touch

Touch assignment								Byte
7	6	5	4	3	2	1	0	
7	6	5	4	3	2	1	0	n
15	14	13	12	11	10	9	8	n + 1
23	22	21	20	19	18	17	16	n + 2
31	30	29	28	27	26	25	24	n + 3
39	38	37	36	35	34	33	32	n + 4

12.4 Description of the ports

12.4.1 Power supply

Plug connector, 2-pin



Pin	Assignment
1	+24 VDC (L+)
2	GND 24 V (M)

12.4.2 X10/IF 1B (RS 422/RS 485)

Sub-D socket, 9-pin, with screw lock

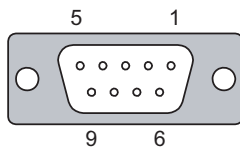

Pin	Assignment for the RS 422	Assignment for the RS 485
1	n. c.	n. c.
2	GND 24 V	GND 24 V
3	TxD+	Data channel B (+)
4	RD+	RTS ¹⁾
5	GND 5 V, floating	GND 5 V, floating
6	+5 VDC, floating	+5 VDC, floating
7	+24 VDC, out (max. 100 mA)	+24 VDC, out (max. 100 mA)
8	TxD-	Data channel A (-)
9	RxD-	RTS ¹⁾

¹⁾ On pin 4 or pin 9, can be set with DIP switch on the rear of the device

12.4.3 X1 (PROFINET)

RJ45 plug connector

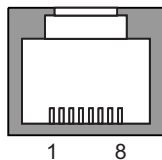

Pin	Assignment
1	Tx+
2	Tx-
3	Rx+
4	n. c.
5	n. c.
6	Rx-
7	n. c.
8	n. c.

12.4.4 X20, X21 (USB)

USB socket

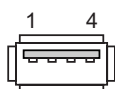

Pin	Assignment
1	+5 VDC, out (max. 500 mA)
2	USB-DN
3	USB-DP
4	GND

12.4.5 X40 (line out)

Line out connector

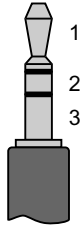

Pin	Assignment
1	Left audio channel
2	Right audio channel
3	GND

Appendix

A.1 ESD guideline

Definition of ESD

All electronic modules are equipped with large-scale integrated ICs or components. Due to their design, these electronic elements are highly sensitive to overvoltage, and thus to any electrostatic discharge. These electronic components are therefore specially identified as ESDs.

Abbreviations

The following abbreviation is commonly used for electrostatic sensitive devices:

- EGB – Elektrostatisch Gefährdete Bauteile/Baugruppen (Germany)
- ESD – Electrostatic Sensitive Device (internationally recognized term)

Labeling

ESDs are labeled with the following symbol:



Electrostatic charging

CAUTION**Electrostatic charging**

ESDs may be destroyed by voltages far below the level perceived by human beings. Voltages of this kind develop when a component or an assembly is touched by a person who is not grounded against static electricity. Usually, it is unlikely that damage to an ESD as a result of overvoltage is detected immediately but may become apparent only after a longer period of operation.

Prevent electrostatic charging of your body before you touch the ESD!

Anyone who is not connected to the electrical potential of their surroundings is subjected to electrostatic charging.

The following figure indicates the maximum electrostatic charge anyone is subjected to when coming into contact with the materials shown. These values correspond with specifications to IEC 801-2.

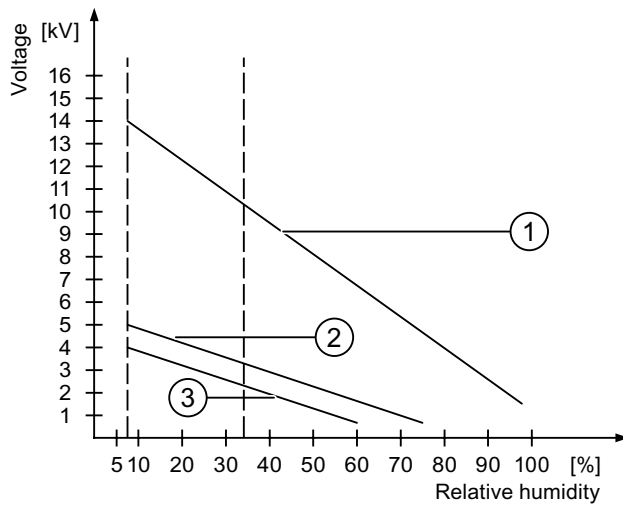

- ① Synthetic materials
- ② Wool
- ③ Antistatic materials such as wood or concrete

Protective measures against electrostatic discharge

CAUTION

Observe grounding measures

When working with electrostatic sensitive devices, make sure that the person, the workplace and the packaging are properly grounded. This helps to avoid electrostatic charging.

As a rule, only touch the ESD if this is unavoidable, for example for maintenance. When you touch modules, make sure that you do not touch the pins on the modules or the PCB tracks. In this way, the discharged energy can not affect the sensitive devices.

Discharge electrostatic electricity from your body if you are performing measurements on an ESD. Do so by touching grounded metallic parts.

Always use grounded measuring instruments.

A.2 System alarms

Introduction

System alarms on the HMI device provide information about internal states of the HMI device and PLC.

The following overview shows the causes of system alarms and how to eliminate the cause of error.

Some of the system alarms described in this section are relevant to individual HMI devices based on their range of features.

Note

System alarms are only indicated if an alarm window was configured. System alarms are output in the language currently set on your HMI device.

System alarm parameters

System alarms may contain encrypted parameters which are relevant to troubleshooting because they provide a reference to the source code of the runtime software. These parameters are output after the text "Error code:"

Meaning of the system alarms

All the system alarms that can be displayed are listed below. The system alarms are divided into different ranges:

10000 - Printer alarms

Number	Effect/cause	Remedy
10000	The print job could not be started or was canceled due to an unknown error. Faulty printer setup. Or: No authorization is available for accessing the network printer. Power supply failure during data transfer.	Check the printer settings, cable connections and the power supply. Set up the printer once again. Obtain a network printer authorization. If the error persists, contact the Hotline!
10001	No printer is installed or a default printer has not been set up.	Install a printer and/or select it as the default printer.
10002	Overflow of the graphics buffer for printing. Up to two images are buffered.	Allow sufficient intervals between successive print jobs.
10003	Images can now be buffered again.	--
10004	Overflow of the buffer for printing lines in text mode (e.g. alarms). Up to 1000 lines are buffered.	Allow sufficient intervals between successive print jobs.
10005	Text lines can now be buffered again.	--
10006	The Windows printing system reports an error. Refer to the output text and the error ID to determine the possible causes. Nothing is printed or the print is faulty.	Repeat the action if necessary.

20000 - Global script alarms

Number	Effect/causes	Remedy
20010	An error has occurred in the specified script line. Execution of the script was therefore aborted. Note the system alarm that may have occurred prior to this.	Select the specified script line in the configuration. Ensure that the tags used are of the allowed types. Check system functions for the correct number and types of parameters.
20011	An error has occurred in a script that was called by the specified script. Execution of the script was therefore aborted in the called script. Note the system alarm that may have occurred prior to this.	In the configuration, select the script that has been called directly or indirectly by the specified script. Ensure that the tags used are of the allowed types. Check system functions for the correct number and types of parameters.
20012	The configuration data is inconsistent. The script could therefore not be generated.	Recompile the configuration.
20013	The scripting component of WinCC flexible Runtime is not correctly installed. Therefore, no scripts can be executed.	Reinstall WinCC flexible Runtime on your PC. Rebuild your project with "Project > Generator > Generate" and transfer the project to the HMI device.
20014	The system function returns a value that is not written in any return tag.	Select the specified script in the configuration. Check whether the script name has been assigned a value.
20015	Too many successive scripts have been triggered in short intervals. When more than 20 scripts are queued for processing, any subsequent scripts are rejected. In this case, the script indicated in the alarm is not executed.	Find what is triggering the scripts. Extend the times, e.g. the polling time of the tags which trigger the scripts.

30000 - Alarms for IFwSetValue: SetValue()

Number	Effect/causes	Remedy
30010	The tag could not accept the function result, e.g. when it has exceeded the value range.	Check the tag type of the system function parameter.
30011	A system function could not be executed because the function was assigned an invalid value or type in the parameter.	Check the parameter value and tag type of the invalid parameter. If a tag is used as a parameter, check its value.
30012	A system function could not be executed because the function was assigned an invalid value or type in the parameter.	Check the parameter value and tag type of the invalid parameter. If a tag is used as a parameter, check its value.

40000 - Linear scaling alarms

Number	Effect/causes	Remedy
40010	The system function could not be executed since the parameters could not be converted to a common tag type.	Check the parameter types in the configuration.
40011	The system function could not be executed since the parameters could not be converted to a common tag type.	Check the parameter types in the configuration.

50000 - Data server alarms

Number	Effect/causes	Remedy
50000	The HMI device is receiving data faster than it is capable of processing. Therefore, no further data is accepted until all current data have been processed. Data exchange then resumes.	--
50001	Data exchange has been resumed.	--

60000 - Win32 function alarms

Number	Effect/causes	Remedy
60000	This alarm is generated by the "DisplaySystemAlarms" function. The text to be displayed is transferred to the function as a parameter.	--
60010	The file could not be copied in the direction defined because one of the two files is currently open or the source/target path is not available. It is possible that the Windows user has no access rights to one of the two files.	Restart the system function or check the paths of the source/target files. Using Windows NT/2000/XP: The user executing WinCC flexible Runtime must be granted access rights for the files.
60011	An attempt was made to copy a file to itself. It is possible that the Windows user has no access rights to one of the two files.	Check the path of the source/target file. Using Windows NT/2000/XP with NTFS: The user executing WinCC flexible Runtime must be granted access rights for the files.

A.2 System alarms

70000 - Win32 function alarms

Number	Effect/causes	Remedy
70010	The application could not be started because it could not be found in the path specified or there is insufficient memory space.	Check whether the application exists in the specified path or close other applications.
70011	The system time could not be modified. The error alarm only appears in connection with area pointer "Date/time PLC". Possible causes: <ul style="list-style-type: none"> An invalid time was transferred in the job mailbox. The Windows user has no right to modify the system time. If the first parameter in the system alarm is displayed with the value 13, the second parameter indicates the byte containing the incorrect value.	Check the time which is to be set. Using Windows NT/2000/XP: The user executing WinCC flexible Runtime must be granted the right to change the system time of the operating system.
70012	An error occurred when executing the function "StopRuntime" with the option "Runtime and operating system". Windows and WinCC flexible Runtime are not closed. One possible cause is that other programs cannot be closed.	Close all programs currently running. Then close Windows.
70013	The system time could not be modified because an invalid value was entered. Incorrect separators may have been used.	Check the time which is to be set.
70014	The system time could not be modified. Possible causes: <ul style="list-style-type: none"> An invalid time was transferred. The Windows user has no right to modify the system time. Windows rejects the setting request.	Check the time which is to be set. Using Windows NT/2000/XP: The user executing WinCC flexible Runtime must be granted the right to change the system time of the operating system.
70015	The system time could not be read because Windows rejects the reading function.	--
70016	An attempt was made to select a screen by means of a system function or job. This is not possible because the screen number specified does not exist. Or: A screen could not be generated due to insufficient system memory. Or: The screen is blocked. Or: Screen call has not been executed correctly.	Check the screen number in the function or job with the screen numbers configured. Assign the number to a screen if necessary. Check the details for the screen call and whether the screen is blocked for specific users.
70017	Date/time is not read from the area pointer because the address set in the PLC is either not available or has not been set up.	Change the address or set up the address in the PLC.
70018	Acknowledgment that the password list has been successfully imported.	--
70019	Acknowledgment that the password list has been successfully exported.	--
70020	Acknowledgment for activation of alarm reporting.	--
70021	Acknowledgment for deactivation of alarm reporting.	--

Number	Effect/causes	Remedy
70022	Acknowledgment to starting the Import Password List action.	--
70023	Acknowledgment to starting the Export Password List action.	--
70024	The value range of the tag has been exceeded in the system function. The calculation of the system function is not performed.	Check the desired calculation and correct it if necessary.
70025	The value range of the tag has been exceeded in the system function. The calculation of the system function is not performed.	Check the desired calculation and correct it if necessary.
70026	No other screens are stored in the internal screen memory. No other screens can be selected.	--
70027	The backup of the RAM file system has been started.	--
70028	The files from the RAM have been copied in the Flash memory. The files from the RAM have been copied in the Flash memory. Following a restart, these saved files are copied back to the RAM file system.	--
70029	Backup of the RAM file system has failed. No backup copy of the RAM file system has been made.	Check the settings in the "Control Panel > OP" dialog and save the RAM file system using the "Save Files" button in the "Persistent Storage" tab.
70030	The parameters configured for the system function are faulty. The connection to the new PLC was not established.	Compare the parameters configured for the system function with the parameters configured for the PLCs and correct them as necessary.
70031	The PLC configured in the system function is not an S7 PLC. The connection to the new PLC was not established.	Compare the S7 PLC name parameter configured for the system function with the parameters configured for the PLC and correct them as necessary.
70032	The object configured with this number in the tab order is not available in the selected screen. The screen changes but the focus is set to the first object.	Check the number of the tab order and correct it if necessary.
70033	An e-mail cannot be sent because a TCP/IP connection to the SMTP server no longer exists. This system alarm is generated only at the first attempt. All subsequent unsuccessful attempts to send an e-mail will no longer generate a system alarm. The event is regenerated when an e-mail has been successfully sent in the meantime. The central e-mail component in WinCC flexible Runtime attempts, in regular intervals (1 minute), to establish the connection to the SMTP server and to send the remaining e-mails.	Check the network connection to the SMTP server and re-establish it if necessary.
70034	Following a disruption, the TCP/IP connection to the SMTP server could be re-established. The queued e-mails are then sent.	--

Number	Effect/causes	Remedy
70036	No SMTP server for sending e-mails is configured. An attempt to connect to an SMTP server has failed and it is not possible to send e-mails. WinCC flexible Runtime generates the system alarm after the first attempt to send an e-mail.	Configure an SMTP server: In WinCC flexible Engineering System using "Device settings > Device settings" In the Windows CE operating system using "Control Panel > Internet Settings > E-mail > SMTP Server"
70037	An e-mail cannot be sent for unknown reasons. The contents of the e-mail are lost.	Check the e-mail parameters (recipient etc.).
70038	The SMTP server has rejected sending or forwarding an e-mail because the domain of the recipient is unknown to the server or because the SMTP server requires authentication. The contents of the e-mail are lost.	Check the domain of the recipient address or deactivate the authentication on the SMTP server if possible. SMTP authentication is currently not used in WinCC flexible Runtime.
70039	The syntax of the e-mail address is incorrect or contains illegal characters. The contents of the e-mail are discarded.	Check the e-mail address of the recipient.
70040	The syntax of the e-mail address is incorrect or contains illegal characters.	--
70041	The import of the user management was aborted due to an error. Nothing was imported.	Check your user management or transfer it again to the panel.
70042	The value range for the tags has been exceeded while executing the system function. The system function calculation has not been carried out.	Check the desired calculation and correct it if necessary.
70043	The value range for the tags has been exceeded while executing the system function. The system function calculation has not been carried out.	Check the desired calculation and correct it if necessary.

80000 - Archive alarms

Number	Effect/causes	Remedy
80001	The log specified is filled to the size defined (in percent) and must be stored elsewhere.	Store the file or table by executing a 'move' or 'copy' function.
80002	A line is missing in the specified log.	--
80003	The copying process for logging was not successful. In this case, it is advisable to check any subsequent system alarms, too.	--
80006	Since logging is not possible, this causes a permanent loss of the functionality.	In the case of databases, check whether the corresponding data source exists and start up the system again.
80009	A copying action has been completed successfully.	--
80010	Since the storage location was incorrectly entered in WinCC flexible, this causes a permanent loss of the functionality.	Configure the storage location for the respective log again and restart the system when the full functionality is required.

Number	Effect/causes	Remedy
80012	Log entries are stored in a buffer. If the values are read to the buffer faster than they can be physically written (using a hard disk, for example), overloading may occur and recording is then stopped.	Archive fewer values. Or: Increase the logging cycle.
80013	The overload status no longer applies. Archiving resumes the recording of all values.	--
80014	The same action was triggered twice in quick succession. Since the process is already in operation, the action is only carried out once.	--
80015	This system alarm is used to report DOS or database errors to the user.	--
80016	The logs are separated by the system function "CloseAllLogs" and the incoming entries exceed the defined buffer size. All entries in the buffer are deleted.	Reconnect the logs.
80017	The number of incoming events cause a buffer overflow. This can be caused, for example, by several copying actions being activated at the same time. All copy jobs are deleted.	Stop the copy action.
80019	The connection between WinCC flexible and all logs were closed, for example, after executing the system function "CloseAllLogs". Entries are written to the buffer and are then written to the logs when a connection is re-established. There is no connection to the storage location and the storage medium may be replaced, for example.	--
80020	The maximum number of simultaneously copy operations has been exceeded. Copying is not executed.	Wait until the current copying actions have been completed, then restart the last copy action.
80021	An attempt was made to delete a log which is still busy with a copy action. Deletion has not been executed.	Wait until the current copying actions have been completed, then restart the last action
80022	An attempt was made to use the system function "StartSequenceLog" to start a sequence log for a log which is not configured as a sequence log. No sequence log file is created.	In the project, check <ul style="list-style-type: none"> • If the "StartSequenceLog" system function was properly configured • if the tag parameters are properly provided with data on the HMI device
80023	An attempt was made to copy a log to itself. The log is not copied.	In the project, check <ul style="list-style-type: none"> • if the "CopyLog" system function was properly configured • if the tag parameters are properly provided with data on the HMI device
80024	The "CopyLog" system function does not allow copying when the target log already contains data ("Mode" parameter). The log is not copied.	Edit the "CopyLog" system function in the project if necessary. Before you initiate the system function, delete the destination log file.

Number	Effect/causes	Remedy
80025	You have canceled the copy operation. Data written up to this point are retained. The destination log file (if configured) is not deleted. The cancellation is reported by an error entry \$RT_ERR\$ at the end of the destination log.	--
80026	This alarm is output after all logs are initialized. Values are written to the logs from then on. Prior to this, no entries are written to the logs, irrespective whether WinCC flexible Runtime is active or not.	--
80027	The internal Flash memory has been specified as the storage location for a log. This is not permissible. No values are written to this log and the log file is not created.	Configure "Storage Card" or a network path as the storage location.
80028	The alarm returns a status report indicating that the logs are currently being initialized. No values are logged until the alarm 80026 is output.	--
80029	The number of logs specified in the alarm could not be initialized. The logs are initialized. The faulty log files are not available for logging jobs.	Evaluate the additional system alarms related to this alarm. Check the configuration, the ODBC (Open Database Connectivity) and the specified drive.
80030	The structure of the existing log file does not match the expected structure. Logging is stopped for this log.	Delete the existing log data manually, in advance.
80031	The log in CSV format is corrupted. The log cannot be used.	Delete the faulty file.
80032	Logs can be assigned events. These are triggered as soon as the log is full. If WinCC flexible Runtime is started and the log is already full, the event is not triggered. The log specified no longer logs data because it is full.	Close WinCC flexible Runtime, delete the log, then restart WinCC flexible Runtime. Or: Configure a button which contains the same actions as the event and press it.
80033	"System Defined" is set in the data log file as the data source name. This causes an error. No data is written to the database logs, whereas the logging to the CSV logs works.	Install MSDE again.
80034	An error has occurred in the initialization of the logs. An attempt has been made to create the tables as a backup. This action was successful. A backup has been made of the tables of the corrupted log file and the cleared log was restarted.	No action is necessary. However, it is recommended to save the backup files or delete them in order to make the space available again.
80035	An error has occurred in the initialization of the logs. An attempt has been made to create backups of the tables and this has failed. No logging or backup has been performed.	It is recommended to save the backups or to delete them in order to release memory.
80044	The export of a log was interrupted because Runtime was closed or due to a power failure. It was detected that the export needed to be resume when Runtime restarted.	The export resumes automatically.

Number	Effect/causes	Remedy
80045	The export of a log was interrupted due to an error in the connection to the server or at the server itself.	The export is repeated automatically. Check: <ul style="list-style-type: none"> • The connection to the server • If the server is running • If there is enough free space on the server
80046	The destination file could not be written while exporting the log.	Check whether there is enough space on the server and if you have permission to create the log file.
80047	The log could not be read while exporting it.	Check whether the storage medium is correctly inserted.
80049	The log could not be renamed while preparing to export it. The job can not be completed."	Check whether the storage medium is correctly inserted and if there is sufficient space on the medium.
80050	The log which shall be exported is not closed. The job can not be completed.	Make sure the "CloseAll Logs" system function is called before using the "ExportLog" system function. Change the configuration as required.

90000 - FDA alarms

Number	Effect/causes	Remedy
90024	No operator actions can be logged due to lack of space on the storage medium for log. The operator action will therefore not be executed.	Make more space available by inserting an empty storage medium or swapping out the log files on the server using "ExportLog".
90025	No user actions can be logged because of error state of the archive. Therefore the user action will not be executed.	Check whether the storage medium is correctly inserted.
90026	No operator actions can be logged because the log is closed. The operator action will therefore not be executed.	Before further operator actions are carried out, the log must be opened again using the system function "OpenAllLogs". Change the configuration as required.
90028	The password you entered is incorrect.	Enter the correct password.
90029	Runtime was closed during ongoing operation (perhaps due to a power failure) or a storage medium in use is incompatible with Audit Trail. An Audit Trail is not suitable if it belongs to another project or has already be archived.	Ensure that you are using the correct storage medium.
90030	Runtime was closed during ongoing operation (perhaps due to a power failure).	--
90031	Runtime was closed during ongoing operation (perhaps due to a power failure).	--
90032	Running out of space on the storage medium for log.	Make more space available by inserting an empty storage medium or swapping out the log files on the server using "ExportLog".
90033	No more space on the storage medium for log. As of now, no more operator actions requiring logging will be executed.	Make more space available by inserting an empty storage medium or swapping out the log files on the server using "ExportLog".
90039	You do not have the necessary authorization to perform this action.	Adapt or upgrade your authorizations.
90040	Audit Trail is switched off because of a forced user action.	Activate the "Audit Trail" again using the system function "StartLog".

Number	Effect/causes	Remedy
90041	A user action which has to be logged has been executed without a logged on user.	A user action requiring logging should only be possible with permission. Change the configuration by setting a required permission for the input object.
90044	A user action which has to be confirmed was blocked, because there is another user action pending.	Repeat the user action if necessary.

110000 - Offline function alarms

Number	Effect/causes	Remedy
110000	The operating mode was changed. "Offline" mode is now set.	--
110001	The operating mode was changed. "Online" mode is now set.	--
110002	The operating mode was not changed.	Check the connection to the PLCs. Check whether the address area for the area pointer 88 "Coordination" in the PLC is available.
110003	The operating mode of the specified PLC was changed by the system function "SetConnectionMode". The operating mode is now "offline".	--
110004	The operating mode of the specified PLC has been changed by the system function "SetConnectionMode". The operating mode is now "online".	--
110005	An attempt was made to use the system function SetConnectionMode to switch the specified PLC to "online" mode, although the entire system is in "offline" mode. This changeover is not allowed. The PLC remains in "offline" mode.	Switch the complete system to "online" mode, then execute the system function again.
110006	The content of the "project version" area pointer does not match the user version configured in WinCC flexible. WinCC flexible Runtime is therefore closed.	Check: <ul style="list-style-type: none"> • The project ID entered on the PLC. • The project ID entered in WinCC flexible.

120000 - Trend alarms

Number	Effect/causes	Remedy
120000	The trend is not displayed because you configured an incorrect axis to the trend or an incorrect trend.	Change the configuration.
120001	The trend is not displayed because you configured an incorrect axis to the trend or an incorrect trend.	Change the configuration.
120002	The trend is not displayed because the tag assigned attempts to access an invalid PLC address.	Check whether the data area for the tag exists in the PLC, the configured address is correct and the value range for the tag is correct.

130000 - System information alarms

Number	Effect/causes	Remedy
130000	The action was not executed.	Close all other programs. Delete files no longer required from the hard disk.
130001	The action was not executed.	Delete files no longer required from the hard disk.
130002	The action was not executed.	Close all other programs. Delete files no longer required from the hard disk.
130003	No data medium found. The operation is canceled.	Check, for example, if <ul style="list-style-type: none"> • The correct data medium is being accessed • The data medium is inserted
130004	The data medium is write-protected. The operation is canceled.	Check whether access has been made to the correct data carrier. Remove the write protection.
130005	The file is read only. The operation is canceled.	Check whether access has been made to the correct file. Edit the file attributes if necessary.
130006	Access to file failed. The operation is canceled.	Check, for example, if <ul style="list-style-type: none"> • The correct file is being accessed • The file exists • Another action is preventing simultaneous access to the file
130007	The network connection is interrupted. Records cannot be saved or read over the network connection.	Check the network connection and eliminate the cause of error.
130008	The storage card is not available. Records cannot be saved to / read from the storage card.	Insert the storage card.
130009	The specified folder does not exist on the storage card. Any files saved to this directory are not backed up when you switch off the HMI device.	Insert the storage card.
130010	The maximum nesting depth can be exhausted when, for example, a value change in a script results in the call of another script and the second script in turn has a value change that results in the call of yet a further script etc. The configured functionality is not supported.	Check the configuration.

140000 - Connection alarms chns7: Connection + device

Number	Effect/causes	Remedy
140000	An online connection to the PLC is established.	--
140001	The online connection to the PLC was shut down.	--
140003	No tag updating or writing is executed.	Check the connection and if the PLC is switched on. Check the parameter definitions in the Control Panel using "Set PG/PC interface". Restart the system.

Number	Effect/causes	Remedy
140004	No tag update or write operations are executed because the access point or the module configuration is faulty.	Verify the connection and check whether the PLC is switched on. Check the access point or the module configuration (MPI, PPI, PROFIBUS) in the Control Panel with "Set PG/PC interface". Restart the system.
140005	No tag updating or writing is executed because the HMI device address is incorrect (possibly too high).	Use a different HMI device address. Verify the connection and check whether the PLC is switched on. Check the parameter definitions in the Control Panel using "Set PG/PC interface". Restart the system.
140006	No tag updating or writing is executed because the baud rate is incorrect.	Select a different baud rate in WinCC flexible (according to module, profile, communication peer, etc.).
140007	Tags are not updated or written because the bus profile is incorrect (see %1). The following parameters could not be written to the registry: 1: Tslot 2: Tqui 3: Tset 4: MinTsdr 5: MaxTsdr 6: Trdy 7: Tid1 8: Tid2 9: Gap Factor 10: Retry Limit	Check the user-defined bus profile. Check the connection and if the PLC is switched on. Check the parameter definitions in the Control Panel using "Set PG/PC interface". Restart the system.
140008	No tag updating or writing is executed because baud rate is incorrect. The following parameters could not be written to the registry: 0: General error 1: Wrong version 2: Profile cannot be written to the registry. 3: The subnet type cannot be written to the registry. 4: The Target Rotation Time cannot be written to the registry. 5: Faulty Highest Address (HSA).	Check the connection and if the PLC is switched on. Check the parameter definitions in the Control Panel using "Set PG/PC interface". Restart the system.
140009	Tags are not updated or written because the module for S7 communication was not found.	Reinstall the module in the Control Panel using "Set PG/PC interface".
140010	No S7 communication partner found because the PLC is shut down. DP/T: The option "PG/PC is the only master" is not set in the Control Panel under "Set PG/PC interface."	Switch the PLC on. DP/T: If only one master is connected to the network, disable "PG/PC is the only master" in "Set PG/PC interface". If several masters are connected to the network, enable these. Do not change any settings, for this will cause bus errors.
140011	No tag updating or writing is executed because communication is down.	Check the connection and that the communication partner is switched on.

Number	Effect/causes	Remedy
140012	There is an initialization problem (e.g. when WinCC flexible Runtime was closed in Task Manager). Or: Another application (e.g. STEP7) with different bus parameters is active and the driver cannot be started with the new bus parameters (transmission rate, for example).	Restart the HMI device. Or: Run WinCC flexible Runtime, then start your other applications.
140013	The MPI cable is disconnected and, thus, there is no power supply.	Check the connections.
140014	The configured bus address is already in use by another application.	Edit the HMI device address in the PLC configuration.
140015	Wrong transmission rate Or: Faulty bus parameters (e.g. HSA) Or: OP address > HSA or: Wrong interrupt vector (interrupt does not arrive at the driver)	Correct the relevant parameters.
140016	The hardware does not support the configured interrupt.	Change the interrupt number.
140017	The set interrupt is in use by another driver.	Change the interrupt number.
140018	The consistency check was disabled by SIMOTION Scout. Only a corresponding note appears.	Enable the consistency check with SIMOTION Scout and once again download the project to the PLC.
140019	SIMOTION Scout is downloading a new project to the PLC. Connection to the PLC is canceled.	Wait until the end of the reconfiguration.
140020	The version in the PLC and that of the project (FWX file) do not match. Connection to the PLC is canceled	The following remedies are available: Download the current version to the PLC using SIMOTION Scout. Regenerate the project using WinCC flexible ES, close WinCC flexible Runtime and restart with a new configuration.

150000 - Connection alarms chnAS511: Connection

Number	Effect/causes	Remedy
150000	No more data is read or written. Possible causes: <ul style="list-style-type: none"> • The cable is defective • The PLC does not respond, is defective, etc. • The wrong port is used for the connection • System overload 	Ensure that the cable is plugged in, the PLC is operational, the correct port is being used. Restart the system if the system alarm persists.
150001	Connection is up because the cause of the interruption has been eliminated.	--

160000 - Connection alarms IVar (WinLC) / OPC: Connection

Number	Effect/causes	Remedy
160000	No more data is read or written. Possible causes: <ul style="list-style-type: none"> • The cable is defective • The PLC does not respond, is defective, etc. • The wrong port is used for the connection • System overload 	Ensure that the cable is plugged in, the PLC is operational, the correct port is being used. Restart the system if the system alarm persists.
160001	Connection is up because the cause of the interruption has been eliminated.	--
160010	No connection to the server because the server identification (CLS-ID) cannot be determined. Values cannot be read or written.	Check access rights.
160011	No connection to the server because the server identification (CLS-ID) cannot be determined. Values cannot be read or written.	Check, for example, if <ul style="list-style-type: none"> • The server name is correct • The computer name is correct • The server is registered
160012	No connection to the server because the server identification (CLS-ID) cannot be determined. Values cannot be read or written.	Check, for example, if <ul style="list-style-type: none"> • The server name is correct • The computer name is correct • The server is registered Note for advanced users: Interpret the value from HRESULT.
160013	The specified server was started as InProc server. This has not been released and may possibly lead to incorrect behavior because the server is running in the same process area as the WinCC flexible Runtime software.	Configure the server as OutProc Server or Local Server.
160014	Only one OPC server project can be started on a PC/MP. An alarm is output when an attempt is made to start a second project. The second project has no OPC server functionality and cannot be located as an OPC server by external sources.	Do not start a second project with OPC server functionality on the computer.

170000 - S7 dialog alarms

Number	Effect/causes	Remedy
170000	S7 diagnostics events are not indicated because it is not possible to log on to the S7 diagnostics functions at this device. The service is not supported.	--
170001	The S7 diagnostics buffer cannot be viewed because communication with the PLC is shut down.	Set the PLC to online mode.
170002	The S7 diagnostics buffer cannot be viewed because reading of the diagnostics buffer (SSL) was canceled with error.	--
170003	An S7 diagnostics event cannot be visualized. The system returns internal error %2.	--

Number	Effect/causes	Remedy
170004	An S7 diagnostics event cannot be visualized. The system returns an internal error of error class %2, error number %3.	--
170007	It is not possible to read the S7 diagnostics buffer (SSL) because this operation was canceled with an internal error of class %2 and error code %3.	--

180000 - Misc/common alarms

Number	Effect/causes	Remedy
180000	A component/OCX received configuration data with a version ID which is not supported.	Install a newer component.
180001	System overload because too many actions running in parallel. Not all the actions can be executed, some are rejected.	Several remedies are available: <ul style="list-style-type: none"> • Generate the alarms at a slower rate (polling) • Initiate scripts and functions at greater intervals If the alarm appears more frequently: Restart the HMI device.
180002	The screen keyboard could not be activated. Possible causes: "TouchInputPC.exe" was not registered due to a faulty Setup.	Reinstall WinCC flexible Runtime.

190000 - Tag alarms

Number	Effect/causes	Remedy
190000	It is possible that the tag is not updated.	--
190001	The tag is updated after the cause of the last error state has been eliminated (return to normal operation).	--
190002	The tag is not updated because communication with the PLC is down.	Select the system function "SetOnline" to go online.
190004	The tag is not updated because the configured tag address does not exist.	Check the configuration.
190005	The tag is not updated because the configured PLC type does not exist for this tag.	Check the configuration.
190006	The tag is not updated because it is not possible to map the PLC type in the data type of the tag.	Check the configuration.
190007	The tag value is not modified because the connection to the PLC is interrupted or the tag is offline.	Set online mode or reconnect to the PLC.
190008	The threshold values configured for the tag have been violated, for example, by <ul style="list-style-type: none"> • A value entered • A system function • A script 	Observe the configured or current threshold values of the tag.

Number	Effect/causes	Remedy
190009	An attempt has been made to assign the tag a value which is outside the permitted range of values for this data type. For example, a value of 260 was entered for a byte tag or a value of -3 for an unsigned word tag.	Observe the range of values for the data type of the tags.
190010	Too many values are written to the tag (for example, in a loop triggered by a script). Values are lost because only up to 100 actions are saved to the buffer.	The following remedies are available: <ul style="list-style-type: none"> • Increase the time interval between multiple write actions. • Do not use an array tag longer than 6 words when you configure an acknowledgment on the HMI device using "Acknowledgment HMI".
190011	Possible cause 1: The value entered could not be written to the configured PLC tag because the high or low limit was exceeded. The system discards the entry and restores the original value. Possible cause 2: The connection to the PLC was interrupted.	Make sure that the value entered lies within the range of values of the control tags. Check the connection to the PLC.
190012	It is not possible to convert a value from a source format to a target format, for example: An attempt is being made to assign a value to a counter that is outside the valid, PLC-specific value range. A tag of the type Integer should be assigned a value of the type String.	Check the range of values or the data type of the tags.
190013	The user has entered a string that is longer than the tag. The string is automatically shortened to the permitted length.	Only enter strings that do not exceed the permitted tag length.

190100 - Area pointer alarms

Number	Effect/causes	Remedy
190100	The area pointer is not updated because the address configured for this pointer does not exist. Type 1 Warnings 2 Errors 3 PLC acknowledgment 4 HMI device acknowledgment 5 LED mapping 6 Trend request 7 Trend transfer 1 8 Trend transfer 2 No.: Consecutive number displayed in WinCC flexible ES.	Check the configuration.
190101	The area pointer is not updated because it is not possible to map the PLC type to the area pointer type. Parameter type and no.: see alarm 190100	--
190102	The area pointer is updated after the cause of the last error state has been eliminated (return to normal operation). Parameter type and no.: See alarm 190100.	--

200000 - PLC coordination alarms

Number	Effect/causes	Remedy
200000	Coordination is not executed because the address configured in the PLC does not exist/is not set.	Change the address or set up the address in the PLC.
200001	Coordination is canceled because the write access to the address configured in the PLC is not possible.	Change the address or set the address in the PLC at an area which allows write access.
200002	Coordination is not carried out at the moment because the address format of the area pointer does not match the internal storage format.	Internal error
200003	Coordination can be executed again because the last error state is eliminated (return to normal operation).	--
200004	The coordination may not be executed.	--
200005	No more data is read or written. Possible causes: <ul style="list-style-type: none"> • The cable is defective • The PLC does not respond, is defective, etc. • System overload 	Ensure that the cable is plugged in and the PLC is operational. Restart the system if the system alarm persists.

200100 - PLC user version alarms

Number	Effect/causes	Remedy
200100	Coordination is not executed because the address configured in the PLC does not exist/is not set.	Change the address or set up the address in the PLC.
200101	Coordination is canceled because the write access to the address configured in the PLC is not possible.	Change the address or set the address in the PLC at an area which allows write access.
200102	Coordination is not carried out at the moment because the address format of the area pointer does not match the internal storage format.	Internal error
200103	Coordination can be executed again because the last error state is eliminated (return to normal operation).	--
200104	The coordination may not be executed.	--
200105	No more data is read or written. Possible causes: <ul style="list-style-type: none"> • The cable is defective • The PLC does not respond, is defective, etc. • System overload 	Ensure that the cable is plugged in and the PLC is operational. Restart the system if the system alarm persists.

210000 - PLC job alarms

Number	Effect/causes	Remedy
210000	Jobs are not processed because the address configured in the PLC does not exist/has not been set up.	Change the address or set up the address in the PLC.
210001	Jobs are not processed because read/write access to the address configured in the PLC is not possible.	Change the address or set up the address in the PLC in an area which allows read/write access.
210002	Jobs are not executed because the address format of the area pointer does not match the internal storage format.	Internal error
210003	The job buffer is processed again because the last error status has been eliminated (return to normal operation).	--
210004	It is possible that the job buffer will not be processed.	--
210005	A control request with an illegal number was initiated.	Check the PLC program.
210006	An error occurred while attempting to execute the control request. As a result, the control request is not executed. Observe the next/previous system alarms.	Check the parameters of the control request. Recompile the configuration.

220000 - WinCC channel adapter alarms

Number	Effect/causes	Remedy
220001	The tag is not downloaded because the associated communication driver / HMI device does not support the download of Boolean/discrete data types.	Change the configuration.
220002	The tag is not downloaded because the associated communication driver / HMI device does not support write access to the data type BYTE.	Change the configuration.
220003	The communication driver cannot be loaded. The driver may not be installed.	Install the driver by reinstalling WinCC flexible Runtime.

Number	Effect/causes	Remedy
220004	Communication is down and no update data is transferred because the cable is not connected or defective etc.	Check the connection.
220005	Communication is up.	--
220006	The connection between the specified PLC and the specified port is active.	--
220007	The connection to the specified PLC is interrupted at the specified port.	Check whether <ul style="list-style-type: none"> • The cable is plugged in • The PLC is OK • The correct port is used • Your configuration is OK (port parameters, protocol settings, PLC address) Restart the system if the system alarm persists.
220008	The communication driver cannot access or open the specified port. The port may be in use by another application or the port used is not available on the destination device. There is no communication with the PLC.	Close all the applications which access this port and restart the computer. Use another port of the system.

230000 - View alarms

Number	Effect/causes	Remedy
230000	The value entered could not be accepted. The system discards the entry and restores the previous value. Either <ul style="list-style-type: none"> • The value range has been exceeded • Illegal characters have been entered • The maximum permitted number of users has been exceeded 	Enter a practical value or delete any unneeded users.
230002	The currently logged in user has not the required authorization. The system therefore discards the input and restored the previous value.	Log on as a user with appropriate authorization.
230003	Changeover to the specified screen failed because the screen is not available/configured. The current screen remains selected.	Configure the screen and check the screen selection function.
230005	The value range of the tag has been exceeded in the I/O field. The original value of the tag is retained.	Observe the range of values for the tag when entering a value.
230100	During navigation in the web browser, the system returned a message which may be of interest to the user. The web browser continues to run but may not (fully) show the new page.	Navigate to another page.
230200	The connection to the HTTP channel was interrupted due to an error. This error is explained in detail by another system alarm. Data is no longer exchanged.	Check the network connection. Check the server configuration.
230201	The connection to HTTP channel was established. Data is exchanged.	--

Number	Effect/causes	Remedy
230202	<p>WININET.DLL has detected an error. This error usually occurs when an attempt to connect to the server fails or the server refuses to connect because the client lacks the proper authorization. An unknown server certificate may also be the cause if the connection is encrypted by means of SSL. The alarm text provides details. This text is always in the language of the Windows installation because it is returned by the Windows OS. Process values are no longer exchanged.</p>	<p>Depending on the cause:</p> <p>When an attempt to connect fails or a timeout error occurs:</p> <ul style="list-style-type: none"> • Check the network connection and the network • Check the server address • Check whether the WebServer is actually running on the destination station. <p>Faulty authorization:</p> <ul style="list-style-type: none"> • The configured user name and/or password do not match those on the server. Establish consistency <p>When the server certificate is rejected: Certificate signed by an unknown CA ():</p> <ul style="list-style-type: none"> • Either ignore this item in your project, or • Install a certificate that has been signed with a root certificate known to the client computer <p>The date of the certificate is invalid:</p> <ul style="list-style-type: none"> • Either ignore this item in your project, or • Install a certificate with a valid date on the server <p>Invalid CN (Common Name or Computer Name):</p> <ul style="list-style-type: none"> • Either ignore this item in your project, or • Install a certificate with a name that corresponds to that of the server address
230203	<p>Although a connection can be made to the server, the HTTP server refuses to connect because</p> <ul style="list-style-type: none"> • WinCC flexible Runtime is not running on the server, or • The HTTP channel is not supported (503 Service unavailable) <p>Other errors can only occur if the Webserver does not support the HTTP channel. The language of the alarm text depends on the Webserver. Data is not exchanged.</p>	<p>Error 503 Service unavailable:</p> <p>Check that WinCC flexible Runtime is running on the server and the HTTP channel is supported.</p>
230301	<p>An internal error has occurred. An English text explains the error in more detail. This may be caused by insufficient memory. OCX does not work.</p>	--
230302	<p>The name of the remote server cannot be resolved. The attempt to connect failed.</p>	<p>Check the configured server address. Check whether the DNS service is available on the network.</p>
230303	<p>The remote server is not running on the addressed computer. Wrong server address. The attempt to connect failed</p>	<p>Check the configured server address. Check whether the remote server is running on the target computer.</p>
230304	<p>The remote server on the addressed computer is incompatible with VNCOCX. The attempt to connect failed.</p>	<p>Use a compatible remote server.</p>
230305	<p>The authentication has failed because the password is incorrect. The attempt to connect failed.</p>	<p>Configure the correct password.</p>

Number	Effect/causes	Remedy
230306	Error in the connection to the remote server. This may occur as a result of network problems. The attempt to connect failed.	Check whether <ul style="list-style-type: none"> • The bus cable is plugged in • There are network problems
230307	The connection to the remote server was shut down because <ul style="list-style-type: none"> • The remote server was shut down, or • The user instructed the server to close all connections The connection is closed.	--
230308	This alarm provides information on the connection status. An attempt is made to connect.	--

240000 - Authorization alarms

Number	Effect/causes	Remedy
240000	WinCC flexible Runtime is operating in demo mode. You have no authorization or your authorization is corrupted.	Install the authorization.
240001	WinCC flexible Runtime is operating in demo mode. Too many tags are configured for the installed version.	Load an adequate authorization / powerpack.
240002	WinCC flexible Runtime is operating with a time-limited emergency authorization.	Restore the full authorization.
240004	Error while reading the emergency authorization. WinCC flexible Runtime is operating in demo mode.	Restart WinCC flexible Runtime, install the authorization or repair the authorization (see Commissioning Instructions Software Protection).
240005	The Automation License Manager has detected an internal system fault. Possible causes: <ul style="list-style-type: none"> • A corrupt file • A defective installation • No free space for the Automation License Manager etc. 	Reboot the HMI device or PC. If this does not solve the problem, remove the Automation License Manager and install it again.

250000 - S7 Force alarms

Number	Effect/causes	Remedy
250000	The tag in the specified line in "Status Force" is not updated because the address configured for this tag is not available.	Check the set address and then verify that the address is set up in the PLC.
250001	The tag in the specified line in "Status Force" is not updated because the PLC type configured for this tag does not exist.	Check the set address.

Appendix

A.2 System alarms

Number	Effect/causes	Remedy
250002	The tag in the specified line in "Status Force" is not updated because it is not possible to map the PLC type in the tag type.	Check the set address.
250003	An attempt to connect to the PLC failed. The tags are not updated.	Check the connection to the PLC. Check that the PLC is switched on and is online.

260000 - Password system alarms

Number	Effect/causes	Remedy
260000	An unknown user or an unknown password has been entered in the system. The current user is logged off from the system.	Log on to the system as a user with a valid password.
260001	The logged in user does not have sufficient authorization to execute the protected functions on the system.	Log on to the system as a user with sufficient authorization.
260002	This alarm is triggered by the system function "TrackUserChange".	--
260003	The user has logged off from the system.	--
260004	The user name entered into the user view already exists in the user management.	Select another user name because user names have to be unique in the user management.
260005	The entry is discarded.	Enter a shorter user name.
260006	The entry is discarded.	Use a shorter or longer password.
260007	The logon timeout value entered is outside the valid range of 0 to 60 minutes. The new value is discarded and the original value is retained.	Enter a logon timeout value between 0 and 60 minutes.
260008	An attempt was made to read a PTPProRun.pwl file created with ProTool V 6.0 in WinCC flexible. Reading the file was canceled due to incompatibility of the format.	--
260009	You have attempted to delete the user "Admin" or "PLC User". These users are fixed components of the user management and cannot be deleted.	If you need to delete a user, because perhaps you have exceeded the maximum number permitted, delete another user.
260012	The passwords entered in the "Change Password" dialog and the confirmation field are not identical. The password has not been changed. User will be logged off.	You have to log on to the system again. Then enter the identical password twice to be able to change the password.
260013	The password entered in the "Change Password" dialog is invalid because it is already in use. The password has not been changed. User will be logged off.	You have to log on to the system again. Then enter a new password that has not been used before.
260014	You have tried unsuccessfully to log on 3 times in succession. You will be locked out and assigned to group no. 0.	You can log on to the system with your correct password. Only an administrator can change the assignment to a group.
260023	The password you entered does not meet the necessary security guidelines.	Enter a password that contains at least one number.
260024	The password you entered does not meet the necessary security guidelines.	Enter a password that contains at least one character.

Number	Effect/causes	Remedy
260025	The password you entered does not meet the necessary security guidelines.	Enter a password that contains at least one special character.
260028	Upon system start-up, an attempt to log on, or when trying to change the password of a SIMATIC log-on user, the system attempts to access the SIMATIC Logon Server. If attempting to log on, the new user is not logged in. If a different user was logged on before, then this user is logged off.	Check the connection to the SIMATIC Logon Server and its configuration; for example: 1. Port number 2. IP address 3. Server name 4. Functional transfer cable Or use a local user.
260029	The SIMATIC Logon user is not associated to any or several groups. The new user is not logged in. If a different user was logged on before, then this user is logged off.	Check the user data on the SIMATIC Logon Server and the configuration in your WinCC flexible project. A user may only be assigned to one group.
260030	The SIMATIC Logon user could not change his password on the SIMATIC Logon Server. The new password may not comply with the password regulations on the server or the user does not have the right to change his password. The old password remains and the user is logged off.	Log in again and choose a different password. Check the password rules on the SIMATIC Logon Server.
260031	It was not possible to log the user on to the SIMATIC Logon Server. The user name or the password could be incorrect or the user does not have sufficient rights to log on. The new user is not logged in. If a different user was logged on before, then this user is logged off.	Try again. If necessary, check the password data on the SIMATIC Logon Server.
260032	It was not possible to log the user on to the SIMATIC Logon Server as his account is blocked. The new user is not logged in. If a different user was logged on before, then this user is logged off.	Check the user data on the SIMATIC Logon Server.
260033	The action change password or log on user could not be carried out.	Check the configuration of the SIMATIC Logon Server.
260034	The last logon operation has not yet ended. A user action or a logon dialog can therefore not be called. The logon dialog is not opened. The user action is not executed.	Wait until the logon operation is complete.
260035	The last attempt to change the password was not completed. A user action or a logon dialog can therefore not be called. The logon dialog is not opened. The user action is not executed.	Wait until the procedure is complete.
260036	There are insufficient licenses on the SIMATIC Logon Sever. The logon is not authorized.	Check the licensing on the SIMATIC Logon Server.
260037	There is no license on the SIMATIC Logon Sever. A logon is not possible. It is not possible to log on via the SIMATIC Logon Server, only via a local user.	Check the licensing on the SIMATIC Logon Server.

270000 - System alarms

Number	Effect/causes	Remedy
270000	A tag is not indicated in the alarm because it attempts to access an invalid address in the PLC.	Check whether the data area for the tag exists in the PLC, the configured address is correct and the value range for the tag is correct.
270001	There is a device-specific limit as to how many alarms may be queued for output (see the operating instructions). This limit has been exceeded. The view no longer contains all the alarms. However, all alarms are written to the alarm buffer.	--
270002	The view shows alarms of a log for which there is no data in the current project. Wildcards are output for the alarms.	Delete older log data if necessary.
270003	The service cannot be set up because too many devices want to use this service. A maximum of four devices may execute this action.	Reduce the number of HMI devices which want to use the service.
270004	Access to persistent buffer is not possible. Alarms cannot be restored or saved.	If the problems persist at the next startup, contact Customer Support (delete Flash).
270005	Persistent buffer damaged: Alarms cannot be restored.	If the problems persist at the next startup, contact Customer Support (delete Flash).
270006	Project modified: Alarms cannot be restored from the persistent buffer.	The project was generated and transferred new to the HMI device; The error should no longer occur when the device starts again.
270007	A configuration problem is preventing the restore (a DLL is missing, a directory is unknown, etc.).	Update the operating system and then transfer your project again to the HMI device.

280000 - DPHMI alarms Connection

Number	Effect/causes	Remedy
280000	Connection is up because the cause of the interruption has been eliminated.	--
280001	No more data is read or written. Possible causes: <ul style="list-style-type: none"> • The cable is defective • The PLC does not respond, is defective, etc. • The wrong port is used for the connection • System overload 	Check whether <ul style="list-style-type: none"> • The cable is plugged in • The PLC is OK • The correct port is used Restart the system if the system alarm persists.
280002	The connection used requires a function block in the PLC. The function block has responded. Communication is now enabled.	--

Number	Effect/causes	Remedy
280003	The connection used requires a function block in the PLC. The function block has not responded.	Check whether <ul style="list-style-type: none"> • The cable is plugged in • The PLC is OK • The correct port is used Restart the system if the system alarm persists. Remedy depends on the error code: 1: The function block must set the COM bit in the response container. 2: The function block must not set the ERROR bit in the response container. 3: The function block must respond within the specified time (timeout). 4: Go online to the PLC.
280004	The connection to the PLC is interrupted. There is no data exchange at present.	Check the connection parameters in WinCC flexible. Ensure that the cable is plugged in, the PLC is operational, the correct port is being used. Restart the system if the system alarm persists.

290000 - Recipe system alarms

Number	Effect/causes	Remedy
290000	The recipe tag could not be read or written. It is assigned the start value. The alarm can be entered in the alarm buffer for up to four more failed tags if necessary. After that, alarm 290003 is output.	Check in the configuration that the address has been set up in the PLC.
290001	An attempt has been made to assign a value to a recipe tag which is outside the value range permitted for this type. The alarm can be entered in the alarm buffer for up to four more failed tags if necessary. After that, alarm 290004 is output.	Observe the value range for the tag type.
290002	It is not possible to convert a value from a source format to a target format. The alarm can be entered in the alarm buffer for up to four more failed recipe tags if necessary. After that, alarm 290005 is output.	Check the value range or type of the tag.
290003	This alarm is output when alarm number 290000 is triggered more than five times. In this case, no further separate alarms are generated.	Check in the configuration that the tag addresses have been set up in the PLC.
290004	This alarm is output when alarm number 290001 is triggered more than five times. In this case, no further separate alarms are generated.	Observe the value range for the tag type.
290005	This alarm is output when alarm number 290002 is triggered more than five times. In this case, no further separate alarms are generated.	Check the value range or type of the tag.
290006	The threshold values configured for the tag have been violated by values entered.	Observe the configured or current threshold values of the tag.

Number	Effect/causes	Remedy
290007	There is a difference between the source and target structure of the recipe currently being processed. The target structure contains an additional data recipe tag which is not available in the source structure. The data recipe tag specified is assigned its start value.	Insert the specified data recipe tag in the source structure.
290008	There is a difference between the source and target structure of the recipe currently being processed. The source structure contains an additional data recipe tag which is not available in the target structure and therefore cannot be assigned. The value is rejected.	Remove the specified data recipe tag in the specified recipe from the project.
290010	The storage location configured for the recipe is not permitted. Possible causes: Illegal characters, write protection, data carrier out of space or does not exist.	Check the configured storage location.
290011	The record with the specified number does not exist.	Check the source for the number (constant or tag value)
290012	The recipe with the specified number does not exist.	Check the source for the number (constant or tag value)
290013	An attempt was made to save a record under a record number which already exists. The action is not executed.	The following remedies are available: <ul style="list-style-type: none"> • Check the source for the number (constant or tag value) • First, delete the record • Change the "Overwrite" function parameter
290014	The file specified to be imported could not be found.	Check: <ul style="list-style-type: none"> • The file name • Ensure that the file is in the specified directory
290020	Alarm reporting that the download of records from the HMI device to the PLC has started.	--
290021	Alarm reporting that the download of records from the HMI device to the PLC was completed.	--
290022	Alarm reporting that the download of records from the HMI device to the PLC was canceled due to an error.	Check in the configuration whether: <ul style="list-style-type: none"> • The tag addresses are configured in the PLC • The recipe number exists • The record number exist • The "Overwrite" function parameter is set
290023	Alarm reporting that the download of records from the PLC to the HMI device has started.	--
290024	Alarm reporting that the download of records from the PLC to the HMI device was completed.	---
290025	Alarm reporting that the download of records from the PLC to the HMI device was canceled due to an error.	Check in the configuration whether: <ul style="list-style-type: none"> • The tag addresses are configured in the PLC • The recipe number exists • The record number exist • The "Overwrite" function parameter is set

Number	Effect/causes	Remedy
290026	An attempt has been made to read/write a record although the record is not free at present. This error may occur in the case of recipes for which downloading with synchronization has been configured.	Set the record status to zero.
290027	Unable to connect to the PLC at present. As a result, the record can neither be read nor written. Possible causes: No physical connection to the PLC (no cable plugged in, cable is defect) or the PLC is switched off.	Check the connection to the PLC.
290030	This alarm is output after you selected screen which contains a recipe view in which a record is already selected.	Reload the record from the storage location or retain the current values.
290031	While saving, it was detected that a record with the specified number already exists.	Overwrite the record or cancel the action.
290032	While exporting records it was detected that a file with the specified name already exists.	Overwrite the file or cancel the process.
290033	Confirmation request before deleting records.	--
290040	A record error with error code %1 that cannot be described in more detail occurred. The action is canceled. It is possible that the record was not installed correctly on the PLC.	Check the storage location, the record, the "Data record" area pointer and if necessary, the connection to the PLC. Restart the action after a short time. If the error persists, contact Customer Support. Forward the relevant error code to Customer Support.
290041	A record or file cannot be saved because the storage location is full.	Delete files no longer required.
290042	An attempt was made to execute several recipe actions simultaneously. The last action was not executed.	Trigger the action again after waiting a short period.
290043	Confirmation request before storing records.	--
290044	The data store for the recipe has been destroyed and is deleted.	--
290050	Alarm reporting that the export of records has started.	--
290051	Alarm reporting that the export of records was completed.	--
290052	Alarm reporting that the export of records was canceled due to an error.	Ensure that the structure of the records at the storage location and the current recipe structure on the HMI device are identical.
290053	Alarm reporting that the import of records has started.	--
290054	Alarm reporting that the import of records was completed.	--
290055	Alarm reporting that the import of records was canceled due to an error.	Ensure that the structure of the records at the storage location and the current recipe structure on the HMI device are identical.
290056	Error when reading/writing the value in the specified line/column. The action was canceled.	Check the specified line/column.

Number	Effect/causes	Remedy
290057	The tags of the recipe specified were toggled from "offline" to "online" mode. Each change of a tag in this recipe is now immediately downloaded to the PLC.	--
290058	The tags of the specified recipe were toggled from "offline" to "online" mode. Modifications to tags in this recipe are no longer immediately transferred to the PLC but must be transferred there explicitly by downloading a record.	--
290059	Alarm reporting that the specified record was saved.	--
290060	Alarm reporting that the specified record memory was cleared.	--
290061	Alarm reporting that clearing of record memory was canceled due to an error.	--
290062	The record number is above the maximum of 65536. This record cannot be created.	Select another number.
290063	This occurs with the system function "ExportDataRecords" when the parameter "Overwrite" is set to No. An attempt has been made to save a recipe under a file name which already exists. The export is canceled.	Check the "ExportDataRecords" system function.
290064	Alarm reporting that the deletion of records has started.	--
290065	Alarm reporting that the deletion of records has successfully completed.	--
290066	Confirmation request before deleting records.	--
290068	Security request to confirm if all records in the recipe should be deleted.	--
290069	Security request to confirm if all records in the recipe should be deleted.	--
290070	The record specified is not in the import file.	Check the source of the record number or record name (constant or tag value).
290071	During the editing of record values, a value was entered which exceeded the low limit of the recipe tag. The entry is discarded.	Enter a value within the limits of the recipe tag.
290072	When editing record values, a value was entered which exceeds the high limit of the recipe tag. The entry is discarded.	Enter a value within the limits of the recipe tag.
290073	An action (e.g. saving a record) failed due to an unknown error. The error corresponds to the status alarm IDS_OUT_CMD_EXE_ERR in the large recipe view.	--
290074	While saving, it was detected that a record with the specified number already exists but under another name.	Overwrite the record, change the record number or cancel the action.
290075	A record with this name already exists. The record is not saved.	Please select a different record name.

Number	Effect/causes	Remedy
290110	The default values could not be set due to an error.	--
290111	The Recipes subsystem cannot be used. Recipe views have no content and recipe-specific functions will not be performed. Possible causes: <ul style="list-style-type: none"> An error occurred while transferring the recipes. The recipe structure was changed in ES. When the project was downloaded again, the recipes were not transferred with it. This means that the new configuration data is not being transferred to the old recipes on the device. 	Transfer the project to the device again, together with the recipes (the corresponding check box in the Transfer dialog must be checked).

300000 - Alarm_S alarms

Number	Effect/causes	Remedy
300000	Faulty configuration of process monitoring (e.g. using PDiag or S7-Graph): More alarms are queued than specified in the specifications of the CPU. No further ALARM_S alarms can be managed by the PLC and reported to the HMI devices.	Change the PLC configuration.
300001	ALARM_S is not registered on this PLC.	Select a controller that supports the ALARM_S service.

310000 - Report system alarms

Number	Effect/causes	Remedy
310000	An attempt is being made to print too many reports in parallel. Only one log file can be output to the printer at a given time; the print job is therefore rejected.	Wait until the previous active log was printed. Repeat the print job if necessary.
310001	An error occurred on triggering the printer. The report is either not printed or printed with errors.	Evaluate the additional system alarms related to this alarm. Repeat the print job if necessary.

320000 - Alarms

Number	Effect/causes	Remedy
320000	The movements have already been indicated by another device. The movements can no longer be controlled.	Deselect the movements on the other display units and select the motion control screen on the required display unit.
320001	The network is too complex. The faulty addresses cannot be indicated.	View the network in STL.
320002	No diagnosable alarm message (error) selected. The unit associated with the alarm message could not be selected.	Select a diagnostics alarm from the ZP_ALARM alarm screen.
320003	No alarm message (error) exists for the selected unit. The detail view cannot visualize any networks.	Select the defective unit from the overview screen.
320004	The required signal states could not be read by the PLC. The faulty addresses cannot be found.	Check the consistency between the configuration on the display unit and the PLC program.

A.2 System alarms

Number	Effect/causes	Remedy
320005	The project contains ProAgent elements which are not installed. ProAgent diagnostic functions cannot be performed	In order to run the project, install the optional ProAgent package.
320006	You have attempted to execute a function which is not supported in the current constellation.	Check the type of the selected unit.
320007	No error-triggering addresses were found on the networks. ProAgent cannot indicate any faulty addresses.	Switch the detail screen to STL layout mode and check the status of the addresses and exclusion addresses.
320008	The diagnostic data stored in the configuration are not synchronized with those in the PLC. ProAgent can only indicate the diagnostic units.	Transfer the project to the HMI device again.
320009	The diagnostic data stored in the configuration are not synchronized with those in the PLC. The diagnostic screens can be operated as usual. ProAgent may be unable to show all diagnostic texts.	Transfer the project to the HMI device again.
320010	The diagnostic data stored in the configuration are not synchronized with those in STEP7. The ProAgent diagnostics data is not up-to-date.	Transfer the project to the HMI device again.
320011	A unit with the corresponding DB number and FB number does not exist. The function cannot be executed.	Check the parameters of the "SelectUnit" function and the units selected in the project.
320012	The "Step sequence mode" dialog is no longer supported.	Use the ZP_STEP step sequence screen from the corresponding standard project for your project. Instead of calling the Overview_Step_Sequence_Mode function, call the "FixedScreenSelection" function using ZP_STEP as the screen name.
320014	The selected PLC cannot be evaluated for ProAgent. The Alarm view assigned to the "EvaluateAlarmDisplayFault" system function could not be found.	Check the parameters of the "EvaluateAlarmDisplayFault" system function.

330000 - GUI alarms

Number	Effect/causes	Remedy
330022	Too many dialogs are open on the HMI device.	Close all dialogs you do not require on the HMI device.
330026	The password will expire after the number of days shown.	Enter a new password.

350000 - GUI alarms

Number	Effect/causes	Remedy
350000	PROFIsafe packages have not arrived within the necessary period. There is a communication problem with the F-CPU. RT is terminated	Check the WLAN connection.
350001	PROFIsafe packages have not arrived within the necessary period. There is a communication problem with the F-CPU. The PROFIsafe connection is re-established.	Check the WLAN connection.
350002	An internal error has occurred. Runtime is terminated	Internal error
350003	Feedback concerning the connection established with the F-CPU. The Emergency-Off buttons are active immediately.	--
350004	PROFIsafe communication was set and the connection was cleared. The Runtime can be terminated. The Emergency-Off buttons are deactivated immediately.	--
350005	Incorrect address configured for the F-slave. No PROFIsafe connection.	Check and modify the address of the F slave in WinCC flexible ES.
350006	The acknowledgement buttons in the "Acknowledgement" and "Panic" functions were not tested before logging on. It is not possible to log onto the effective range.	Press the two acknowledgement buttons one after another in the "Acknowledgement" and "Panic" positions.
350008	The wrong number of failsafe buttons was configured. No PROFIsafe connection.	Change the number of failsafe buttons in the project.
350009	The device is in Override mode. It may no longer be possible to detect the location because transponder detection fails.	Exit Override mode.
350010	Internal error: The device has no failsafe buttons.	Send the device back. Worldwide contact person

Abbreviations

ANSI	American National Standards Institution
CPU	Central Processing Unit
CSV	Comma Separated Values
CTS	Clear To Send
DC	Direct Current
DCD	Data Carrier Detect
DHCP	Dynamic Host Configuration Protocol
DIL	Dual-in-Line (electronic chip housing design)
DNS	Domain Name System
DP	Distributed I/O
DSN	Data Source Name
DSR	Data Set Ready
DTR	Data Terminal Ready
IO	Input and Output
ESD	Components and modules endangered by electrostatic discharge
EMC	Electromagnetic Compatibility
EN	European standard
ES	Engineering System
ESD	Components and modules endangered by electrostatic discharge
GND	Ground
HF	High Frequency
HMI	Human Machine Interface
IEC	International Electronic Commission
IF	Interface
IP	Internet Protocol
LED	Light Emitting Diode
MAC	Media Access Control
MOS	Metal Oxide Semiconductor
MPI	Multipoint Interface (SIMATIC S7)
MS	Microsoft
MTBF	Mean Time Between Failures
n. c.	Not connected
OP	Operator Panel
PC	Personal Computer
PG	Programming device
PPI	Point-to-Point Interface (SIMATIC S7)
RAM	Random Access Memory
PELV	Protective Extra Low Voltage
RJ45	Registered Jack Type 45
RTS	Request to send

RxD	Receive Data
SD Card	Security Digital Card
SELV	Safety Extra Low Voltage
SP	Service Pack
PLC	Programmable Logic Controller
STN	Super Twisted Nematic
Sub-D	Subminiature D (plug)
TAB	Tabulator
TCP/IP	Transmission Control Protocol/Internet Protocol
TFT	Thin Film Transistor
TTY	Teletype
TxD	Transmit Data
UL	Underwriter's Laboratory
USB	Universal Serial Bus
UPS	Uninterruptible power supply
WINS	Windows Internet Naming Service

Glossary

"Transfer" mode

An operating mode of the HMI device in which an executable project is transferred from the configuring PC to an HMI device.

Acknowledge

Acknowledgment of an alarm confirms that it has been noted.

Alarm logging

Output of user-specific alarms to a printer, in parallel to their output to the HMI device screen.

Alarm, acknowledging

Acknowledgment of an alarm confirms that it has been noted.

Alarm, activated

Moment at which an alarm is triggered by the PLC or HMI device.

Alarm, deactivated

Moment at which the initiation of an alarm is reset by the PLC.

Alarm, user-specific

A user-specific alarm designates a certain operating status of the plant connected to the HMI device via the PLC.

Automation device

PLC of the SIMATIC S5 series, for example the AG S5-115U

Automation system

Controller of the SIMATIC S7 series, for example a SIMATIC S7-300

Bootloader

Used to start the operating system. Automatically started when the HMI device is switched on. After the operating system has been loaded, the Loader opens.

Configuration software

Software used to generate projects used for the purpose of process visualization. An example of configuring software is WinCC flexible.

Configuring PC

A configuring PC is a programming device or PC on which plant projects are created using an engineering software.

Display duration

Defines whether a system alarm is displayed on the HMI device and the duration of the display.

EMC

Electromagnetic compatibility is the ability of electrical equipment to function properly in its electromagnetic environment without influencing this environment.

Event

Functions are triggered by defined incoming events. Events can be configured. Events which can be assigned to a button include "Press" and "Release", for example.

Field array

Area reserved in configured screens for the input and output of values.

Flash memory

Non-volatile memory with EEPROM chips, used as mobile storage medium or as memory module installed permanently on the motherboard.

Function keys

Key on the HMI device which supports user-specific functions. A function is assigned to the key in the configuration. The assignment of the keys may be specific to an active screen or not.

Half Brightness Life Time

Time period after which the brightness reaches 50% of the original value. The specified value is dependent on the operating temperature.

Hardcopy

Output of the screen content to a printer.

HMI device

An HMI device is a device used for the operation and monitoring of machines and plants. The statuses of the machine or plant are indicated by means of graphic elements or by indicator lamps on the HMI device. The operating elements of the HMI device allow the operator to interact with the processes of the machine or plant.

HMI device image

A file that can be transferred from the configuring PC to the HMI device. The HMI device image contains the operating system and elements of the runtime software required to run a project.

I/O field

An I/O field enables the input or output of values on the HMI device which are transferred to the PLC.

Infotext

An infotext is a configured information on objects within a project. Infotext for an alarm, for example, may contain information on the cause of the fault and troubleshooting routines.

Object

An object is a component of a project. Example: screen or alarm. Objects are used to view or enter texts and values on the HMI device.

Operating element

Component of a project used to enter values and trigger functions. A button, for example, is an operating element.

Plant

General term referring to machines, processing centers, systems, plants and processes which are operated and monitored on an HMI device.

PLC

A PLC is a general term for devices and systems with which the HMI device communicates, e.g. SIMATIC S7.

PLC job

A PLC job triggers a function for the PLC at the HMI device.

Process visualization

Visualization of technical processes by means of text and graphic elements. Configured plant screens allow operator intervention in active plant processes by means of the input and output data.

Project

Result of a configuration using a configuration software. The project normally contains several screens with embedded system-specific objects, basic settings and alarms. The project file of a project configured in WinCC flexible is saved under the file name extension *.hmi.

You need to distinguish between a project on the configuring PC and that on an HMI device. A project may be available in more languages on the configuring PC than can be managed on the HMI device. The project on the configuring PC can also be set up for different HMI devices. Only the runtime project that has been generated for the respective HMI device can be transferred to it.

Project file

File generated from the runtime project file for use on the HMI device. The project file is normally not transferred and remains on the configuring PC.

The file name extension of a source file is *.hmi.

Project file, compressed

Compressed format of the project file. The compressed project file can be transferred together with the runtime project file to the respective HMI device. For this purpose, backtransfer must be enabled in the project on the configuring PC. The compressed project file is normally stored on an external memory card.

The file extension of a compressed file is *.pdz.

Recipe

Combination of tags forming a fixed data structure. The data structure configured can be assigned data on the HMI device and is then referred to as a record. The use of recipes ensures that all the assigned data is transferred synchronously to the PLC during the transfer of a record.

Runtime project file

File generated from the project file for a specific HMI device. The runtime project file is transferred to the corresponding HMI device and used to operate and monitor plants.

The extension of a compressed file is *.pdz.

Runtime software

The runtime software is a process visualization software used to test a project on a configuring PC.

Screen

Form of the visualization of all logically related process data for a plant. The visualization of the process data can be supported by graphic objects.

Screen object

Configured object used to display or operate the plant, e.g. rectangle, I/O field or alarm view.

STEP 7

STEP 7 is the programming software for SIMATIC S7, SIMATIC C7 and SIMATIC WinAC PLCs.

STEP 7 Micro/WIN

STEP 7 Micro/WIN is the programming software for SIMATIC S7-200 PLCs.

Symbolic I/O field

A symbolic I/O field is a field for the input and output of the value. Contains a list of default entries from which one can be selected.

System alarm

A system alarm is assigned to the "System" alarm class. A system alarm refers to internal states on the HMI device and the PLC.

Tab sequence

During configuration, this defines the sequence in which objects are activated on pressing the <TAB> key.

Tag

Defined memory location to which values can be written to and read from. This can be done from the PLC or the HMI device. Based on whether the tag is interconnected with the PLC or not, we distinguish between "external" tags (process tags) and "internal" tags.

Transfer

Transfer of a runtime project from the configuring PC to the HMI device.

Index

/

/Audit, 32

A

Accessory kit, 25

ACK, 239

ACK key, 203

Acknowledge

Alarm, 203, 243

Error alarm, 243

Acknowledge key, 203

Acoustic feedback, 191

Acoustic signal, 196

For inadvertent operation, 191

with inadvertent operation, 99

Acoustics

Feedback, 122, 124

Address assignment

TCP/IP network, 145

Addressing, 142

Admin, 233, 234, 235

Alarm, 237

Acknowledge, 203, 243

Editing, 244

Functional scope, 29

LED, 240

Alarm buffer, 238

Functional scope, 29

Alarm class, 238, 241

Alarm event, 237

Alarm group, 238

Alarm indicator, 239

Alarm line, 240

Alarm log, 238

Alarm report, 238

Alarm view, 240

Expanded, 240

Simple, 240

Alarm window, 241

ALARM_S, 29

Alphanumeric

Key assignment, 105, 202

Screen keyboard, 197

Alphanumeric value

Changing, 207

Editing, 198

Entering, 198, 207

ALT key, 105, 202

Ambient conditions

Climatic, 46

Mechanical, 45

Test, 46

Approvals, 39

Authorization, 224

Automatic

Transfer, 164

Automation License Manager, 186

A-Z key, 105, 202

B

Backlighting

Reducing, 119

Setting, 99

Backspace key, 104, 202

Backtransfer, 163, 166

Backup, 98, 155, 162, 168, 169, 171, 225

Registry Information, 98, 116

Temporary files, 116

to external storage device, 98, 153

With ProSave, 171

With WinCC flexible, 169

Bar, 210

Basic adapter, 27

Basic knowledge

Required, 3

Booting, 125

Bottom view, 15, 17, 19, 21, 23

Brightness

Changing, 118

Browser

Home page, 98

Setting, 98

Bus connection, 33

Bus parameters

Profile, 141

C

Cable

Data exchange, 76

Cables

Connecting, 61

Calibrating
 Touch screen, 98, 110
Cancel
 Secure mode, 94
Cancel
 Password protection, 113
Cancel key, 104, 202
Care, 273
CE approval, 39
Certificate
 Delete, 98, 152
 Importing, 98, 152
 LED, 98
Changing
 Brightness, 118
 User data, 233, 234
Character repeat, 98
 Screen keyboard, 107
Clean screen, 274
Cleaning product, 273
Clearance
 MP 377, 49
Climatic
 Storage conditions, 44
 Transport conditions, 44
Closing
 Project, 236
 Rear wall, 80
Column sequence
 Alarm view, 241
Compatibility conflict, 168
Conductor cross-section, 65
 Equipotential bonding, 63
Configuration PC
 Connecting, 71
 Wiring diagram, 71
Configuration phase, 159
Configure
 Screen keyboard, 98, 106
Configuring
 Network, 143
 Operating system, 89
 PC/PPI cable, 72
 RS-422/RS-485 port, 70
Configuring PC, 159
Connecting
 Configuration PC, 71
 Equipotential bonding, 63
 Mains terminal, 66
 PLC, 68
 Power supply, 65, 66
 Printer, 75
 PROFINET, 69

 UPS, 67
 USB device, 74
Connection, 33
Connection graphic
 UPS, 67
Connection sequence, 61
Connections to PLC
 Number, 33
Contact person, 5
Control cabinet
 Working on, 38
Control key, 82
 Keyboard unit, 104
Control panel
 Password protection, 92
Control Panel, 96
 MPI, 140
 Open, 97
 Operating, 100, 102
 PROFIBUS, 140
 Screen keyboard, 101
Conventions, 4
Cookies, 98, 150
Creating
 Recipe data record, 255, 264
 Users, 230
C-Tick mark (Australia), 40
CTRL key, 105, 202
Currency, 98
Cursor key, 82, 104, 201

D

Data channel
 Enabling, 136
 Locking, 136
 Parameter assignment, 99, 136
Data flow, 249
Date, 98
 Entering, 199, 208
 Setting, 114
 Synchronizing, 115
Date format, 98, 116
Date/time properties, 98, 114
Decimal, 195
Default gateway, 146
Degree of protection, 48
 Protection against ingress of solid foreign
 bodies, 50, 52
 Protection against water, 50, 52
Delay time
 Setting, 99, 131

- Delete
 - Certificate, 98, 152
 - Recipe data record, 258, 266
 - Users, 235
 - Delete key, 104, 202
 - Device name
 - For network operation, 144
 - Setting, 99
 - Dewing, 44
 - DHCP, 146
 - DIP switch
 - Setting, 70
 - Direct key, 192
 - Bit assignment, 282
 - Functional scope, 31
 - Display
 - MP 377, 280
 - Display format, 205
 - Displaying
 - Info text, 200, 209
 - Information on the MP 377, 127
 - Infotext, 203
 - Memory information, 129
 - System information, 129
 - Disposal, 5
 - Disturbance
 - Pulse-shaped, 42
 - Sinusoidal, 43
 - DNS, 146
 - Server, 142
 - Documentation
 - Enclosed, 53
 - Double-click, 98
 - Setting, 108
 - Drop down list, 199, 208
 - Drop down list box
 - Open, 104, 202
- E**
- EC Declaration of Conformity, 39
 - Editing
 - Alarm, 244
 - Recipe data record, 257, 265
 - Elbow adapter, 26
 - Electrical isolation
 - Safe, 66
 - Electrical potential difference, 63
 - Electrostatic charging, 287
 - Electrostatic discharge
 - Electrostatic, 287
 - Precautions, 288
 - Element list, 251, 262
 - E-Mail
 - Setting, 99, 148
 - EMC directive, 39
 - Emission, 41, 43
 - Encryption, 150
 - END key, 104, 201
 - Enhanced alarm view, 240
 - Enhanced recipe view, 250
 - Enhanced user view, 226
 - Enter key, 202
 - ENTER key, 104, 202
 - Entering
 - Alphanumerical value, 198, 207
 - Date, 199, 208
 - Key combination, 105, 202
 - Numerical value, 196, 206
 - Recipe data record, 271
 - Symbolic value, 199
 - Text box, 194
 - Time, 199, 208
 - Entry on the HMI device
 - By means of function key, 204
 - Using operating elements, 189
 - Equipotential bonding
 - Cable, 64
 - Connecting, 63
 - Requirements, 63
 - Wiring diagram, 64
 - Equipotential bonding rail, 64
 - Error alarm
 - Acknowledge, 243
 - ESC key, 104, 202
 - ESD
 - Abbreviations, 287
 - Labeling, 287
 - Ethernet settings
 - IP address, 146
 - Excel Viewer, 32
 - Explorer
 - Operating, 91
 - Exporting
 - Recipe data record, 270
 - External
 - Keyboard, 100
 - Mouse, 100
- F**
- Factory setting
 - With ProSave, 180
 - With WinCC flexible, 178

- Factory settings, 73
- Feedback
 - Acoustic, 122, 124, 191
 - Optical, 191
- FM Approval, 40
- FN key, 105, 202
- Front view, 15, 17, 19, 21, 23
- Function
 - Additional, 31
- Function key
 - Labeling, 86
- Function keys, 82
 - Global assignment, 204
 - Local assignment, 204
- Function test, 78
- Functional scope
 - Alarm buffer, 29
 - ALARM_S, 29
 - Alarms, 29
 - Graphics list, 29
 - Info text, 31
 - Limit value monitoring, 29
 - Log, 30
 - Recipe, 30
 - Safety, 31
 - Scaling, 29
 - Screen, 30
 - Tags, 29
 - Text list, 29

G

- Gauge, 210
- Graphics list
 - Functional scope, 29
- Group acknowledgement, 203

H

- High frequency radiation, 37
- HMI device
 - EMC-compatible installation, 42
 - Information, 98
 - Mounting, 57, 59
 - Ports, 62
 - Restart, 125
 - Restarting, 98
 - Shutting down, 78
 - Switching on, 77
 - Technical specifications, 280
 - Testing, 77
- HMI Input Panel

- Options, 106
- HOME key, 104, 201
- Home page
 - Internet, 149
- Host cable
 - Safety instruction, 73

I

- Identification, 147
- Importing
 - Certificate, 98, 152
 - Recipe data record, 269
- Inadvertent operation
 - Acoustic signal, 99, 191
- Info text
 - Displaying, 200, 209
 - Functional scope, 31
- Information
 - For the HMI device, 127
- Infotext
 - Displaying, 203
 - Key, 203
 - LED, 242
- Initial startup, 159
- Input device
 - MP 377, 280
- Input Panel, 98
- Installing
 - Option, 162, 182, 183, 185
- Instructions
 - General, 41
- Insulation test
 - Test voltage, 50, 52
- Interface
 - Rated load, 74
- Interfaces
 - MP 377, 281
- Internal clock, 115
- Internet
 - Browser, 92
 - Explorer, 92
 - Home page, 149
 - Options, 98
 - Search engine, 149
 - Security settings, 98
 - Service, 5
 - Settings, 99, 148
 - Support, 5
- Internet options
 - Privacy, 151
- IP address

Ethernet, 146
Setting, 98

K

Key

ACK, 203
ALT, 105, 202
A-Z, 105, 202
Backspace, 202
Cancel, 104
CTRL, 105, 202
Cursor, 104, 201
Delete, 104, 202
END, 104, 201
ENTER, 104, 202
ESC, 104, 202
FN, 105, 202
HOME, 104, 201
Infotext, 203
Scroll back, 104, 201
Scroll forward, 104, 201
SHIFT, 105, 202
TAB, 104, 201
Tabulator, 104

Key combination

Entering, 105, 202

Key control, 201, 205

Trend view, 214

Keyboard

External, 100
Safety instruction, 82

Keyboard properties, 98

L

Labeling

Approvals, 40
EC Declaration of Conformity, 39
Function key, 86

Labeling strips

Attaching, 87
Dimensions, 86
Printing, 86

LAN connection, 98

Language change

Functional scope, 31

Layout

Slider control, 214
Sm@rtClient view, 220
Trend view, 212

LED

Alarm, 240
Certificate, 98
HMI device information, 98
Infotext, 242
Memory information, 128
System information, 128

LED ACK, 239

License key, 186

Transferring, 162, 187
Transferring back, 162, 188

Limit value

For password, 225
For user, 225
For user view, 225

Limit value check, 195

Limit value monitoring

Functional scope, 29

Limit value test, 205

List of abbreviations, 321

Loader, 89

Opening, 90
Operating, 90

Log

Functional scope, 30

Logoff

Users, 228

Logoff time, 225

Logon

Users, 227

Logon data, 147

M

MAC address, 134

Main dimensions

MP 377 PRO 15" Touch, 279

Mains terminal

Connecting, 66

Maintenance, 273, 274

Manual

Production sequence, 272
Transfer, 163

Mechanical

Storage conditions, 44
Transport conditions, 44

Media Player, 93

Memory

MP 377, 280

Memory card, 27

Backup, 84
First use, 153
Inserting, 83

- Restoring file system, 116
- Unplug, 85
- Memory information, 99
 - Displaying, 129
 - LED, 128
- Memory management, 98, 158
- Menu command
 - Simple recipe view, 263
- Microsoft Excel Viewer, 32
- Microsoft PDF Viewer, 32
- Microsoft Word Viewer, 32
- Monitoring mode
 - Sm@rtClient view, 221
- Mounting, 48
 - EMC-compatible, 42
 - HMI device, 57, 59
 - Mounting clamp, 56
- Mounting clamp
 - Mounting, 55, 56
- Mounting cutout
 - Dimensions, 49
 - Preparing, 49
- Mounting location, 48, 51
- Mounting position, 47
 - Thin Client 15, 51
- Mouse
 - External, 100
- Mouse properties, 98
- MP 377
 - Clearance, 49
 - Display, 280
 - Displaying information, 127
 - Input device, 280
 - Interfaces, 281
 - Memory, 280
 - Operating element, 81
 - Ports, 62
 - Weight, 280
- MP 377 12" Key
 - Bottom view, 17
 - Front view, 17
 - Overall dimensions, 276
 - Rear view, 18
 - Side view, 17
- MP 377 12" Touch
 - Bottom view, 15
 - Front view, 15
 - Overall dimensions, 275
 - Rear view, 16
 - Side view, 15
- MP 377 15 PRO
 - Bottom view, 23
 - Front view, 23

- Rear view, 24
- Side view, 23
- MP 377 15" Touch
 - Bottom view, 19
 - Front view, 19
 - Overall dimensions, 277
 - Rear view, 20
 - Side view, 19
- MP 377 19" Touch
 - Bottom view, 21
 - Front view, 21
 - Overall dimensions, 278
 - Rear view, 22
 - Side view, 21
- MP 377 PRO 15" Touch
 - Main dimensions, 279
- MPI
 - Setting, 99, 140
- Multi-key operation, 190, 203
- Multimedia card, 83

N

- Name server, 146
- Network
 - Configuring, 143
 - Logon data, 98
 - Set up, 142
 - Setting, 145
- Network & dial-up connections, 98
- Network ID, 98
- Network operation
 - Device name, 144
 - Options, 99
- Non-isolated plant configuration, 66
- Notice of protected rights, 3
- Number format, 98, 116
- Numerical
 - Key assignment, 105, 202
 - Screen keyboard, 195
- Numerical value
 - Changing, 206
 - Decimal places, 195
 - Display format, 205
 - Editing, 196
 - Entering, 196, 206
 - Limit value check, 195
 - Limit value test, 205

O

- Office location, 5

- Offline
 - Operating mode, 160
 - Recipe tag, 254
 - Test, 167
 - Online
 - Operating mode, 160
 - Recipe tag, 254
 - Test, 167
 - OP properties, 98
 - Device, 127
 - Memory monitoring, 158
 - Persistent storage, 117
 - Touch, 110
 - OPC server, 32
 - Open
 - Control Panel, 97
 - Drop down list box, 104, 202
 - Opening
 - Loader, 90
 - Operating
 - Control Panel, 100, 102
 - Explorer, 91
 - Feedback, 190
 - Key, 201, 205
 - Loader, 90
 - Operating element, 104, 201
 - Project, 189
 - Recipe screen, 255, 264
 - Slider control, 215
 - Switches, 211
 - Trend view, 213
 - Windows CE interface, 91
 - With external keyboard, 190
 - With external mouse, 190
 - Operating element
 - Operating, 104, 201
 - Recipe view, 255
 - Selecting, 104
 - Simple recipe view, 262
 - Operating instructions
 - Purpose of, 3
 - Scope, 3
 - Operating mode, 160
 - Changing, 160
 - Offline, 160
 - Online, 160
 - Transfer, 77, 160
 - Operating system
 - Configuring, 89
 - Update, 173
 - Update via ProSave, 176
 - Updating using WinCC flexible, 175
 - Operation feedback, 190
 - Setting, 99
 - Operator control options, 99
 - Optical feedback, 191
 - Option
 - Installing, 162, 182
 - Installing with ProSave, 185
 - Installing with WinCC flexible, 183
 - Removing, 162, 182
 - Removing with ProSave, 186
 - Removing with WinCC flexible, 184
 - Options, 32
 - Network operation, 99
 - Overall dimensions
 - MP 377 12" Key, 276
 - MP 377 12" Touch, 275
 - MP 377 15" Touch, 277
 - MP 377 19" Touch, 278
- P**
- Parameter assignment
 - Data channel, 99, 136
 - Password, 225
 - Backup, 225
 - Restoring, 225
 - Specifying, 112
 - Password list, 225
 - Password properties, 98, 112, 113
 - Password protection, 92, 98
 - Cancel, 113
 - Set up, 112
 - Windows CE taskbar, 92
 - PC/PPI
 - Configuring the cable, 72
 - Setting the adapter, 72
 - PDF Viewer, 32
 - PELV, 66
 - Permissions in remote control, 222, 223
 - Plant configuration
 - Non-isolated, 66
 - PLC
 - Configuring the interface, 70
 - Connecting, 68
 - Number of connectable, 33
 - Protocol, 34
 - Reading recipe data record, 260, 267
 - Transferring recipe data record, 261, 268
 - Wiring diagram, 68
 - PLC_User, 233, 234, 235
 - Power failure, 168
 - Power supply
 - Connecting, 65, 66

- Setting, 99
- State, 99
- Wiring diagram, 65
- Precautions
 - Electrostatic discharge, 288
- Printer
 - Connecting, 75
 - Setting properties, 98
 - Wiring diagram, 75
- Printer connection
 - Setting, 120
- Printer properties, 98, 121
- Printing
 - Labeling strips, 86
 - Via network printer, 143
- ProAgent, 32
- Process control phase, 159
- Production sequence
 - Manual, 272
- PROFIBUS DP
 - Setting, 99, 140
- PROFINET, 142
 - Addressing, 142
 - Connecting, 69
- PROFINET IO
 - Communication, 69
 - Communication fault, 33
 - Disabling direct keys, 134
 - Enabling direct keys, 134
 - Setting, 98
- Project
 - Closing, 236
 - in ProTool, 161
 - In WinCC flexible, 161
 - Offline testing, 167
 - Operating, 189
 - Reuse, 161
 - Testing online, 167
 - Transferring, 159, 162
- Proper use, 37
- Protected trademark, 3
- Protection class, 50, 52
- Protective foil, 26
- Protocol
 - PLC, 34
- Proxy
 - Server, 98, 148, 150
 - Setting, 98

R

- Radiation

- High frequency, 37
- Radio interference, 41
 - Emission, 43
- Rated load
 - Interface, 74
- Rated voltage, 50, 52
- Reading out
 - Recipe data record, 260, 267
- Real-time clock
 - Internal, 115
- Rear view, 16, 18, 20, 22, 24
- Rear wall
 - Closing, 80
- Recipe, 246
 - Control, 247
 - Data flow, 249
 - Data record, 247
 - Field of application, 245
 - Functional scope, 30
 - Recipe screen, 250
 - Recipe view, 250
 - Synchronizing tags, 259
- Recipe data record
 - Creating, 255, 264
 - Delete, 258, 266
 - Editing, 257, 265
 - Entering, 271
 - Exporting, 270
 - Importing, 269
 - Reading from PLC, 260, 267
 - Synchronize with PLC, 257
 - Transferring to PLC, 261, 268
- Recipe list, 251, 262
- Recipe screen, 252
 - Operating, 255, 264
 - Overview, 252
- Recipe tag
 - Offline, 254
 - Online, 254
 - Synchronizing, 253, 259
- Recipe view, 250
 - Expanded, 250
 - Operating element, 255
 - Simple, 251
- Recommissioning, 159
- Record list, 251, 262
- Recycling, 5
- Regional and language settings, 98, 116
- Regional settings, 116
- Registered trademark, 3
- Registry Information
 - Backup, 98, 116
- Regulations for the prevention of accidents, 38

- Remote control
 - Forcing permission, 222, 223
 - Start, 222, 223
 - Removing
 - Option, 162, 182, 184, 186
 - Repairs, 274
 - Reset to factory setting, 162
 - Restore, 98, 153, 168
 - Restoring, 162, 170, 172, 225
 - from external storage device, 98, 155
 - From memory card, 116
 - With ProSave, 172
 - With WinCC flexible, 170
 - Restoring factory settings, 73
 - Returns Center, 274
 - Reverse polarity protection, 66
 - RS 422 to RS 232 converter, 26
 - RS-422/RS-485 port
 - Configuring, 70
 - Ruler
 - Trend view, 213
- S**
- S7 transfer settings, 99
 - Safe electrical isolation, 66
 - Safety
 - Functional scope, 31
 - Standards, 39
 - Safety instruction
 - Backlighting, 119
 - Changed tag name, 259
 - Compatibility conflict, 168
 - Compressed project file, 163
 - Damage to the HMI device, 61
 - Data channel, 174
 - Data loss, 153, 173
 - Device name, 134
 - Direct key, 192
 - Electrostatic charging, 287
 - Equipotential bonding cable, 64
 - Functional problem, 74
 - High frequency radiation, 37
 - Keyboard, 82
 - License key, 174, 182
 - Loss of data possible, 155
 - Memory card, 85
 - Memory distribution, 129
 - Multi-key operation, 190
 - Observe grounding measures, 288
 - Path, 130, 131
 - Power failure, 168
 - Preventing inadvertent operation, 273, 274
 - Project file, 130, 131
 - Recipe data record in background, 251
 - Remote control for channel 1, 137
 - Restart, 125
 - Storage, 44
 - Switching infotext, 200, 209
 - Time-dependent reactions, 115
 - Touch screen, 81
 - Transfer mode, 139
 - Transfer mode channel 2, 137
 - Transport, 44
 - Unintentional action, 81, 82, 203
 - Unintentional response, 273, 274
 - Unintentional transfer mode, 136
 - USB connection sequence, 73
 - USB host-to-host cable, 73
 - USB port, 74
 - Working on the control cabinet, 38
 - Safety regulations, 38
 - Scaling
 - Functional scope, 29
 - Screen
 - Functional scope, 30
 - Screen keyboard, 98, 193
 - Alphanumerical, 197
 - Change layout, 102
 - Character repeat, 107
 - Configure, 106
 - For Control Panel, 101
 - Keyboard level, 197
 - Language change, 197
 - Numerical, 195
 - Representation types, 101
 - Screen saver, 99, 120
 - Setting, 119
 - Screen settings
 - Changing, 98
 - Scroll back key, 104, 201
 - Scroll forward key, 104, 201
 - Search engine
 - Internet, 149
 - Secure mode, 94
 - Cancel, 94
 - Security settings, 98
 - Security system, 224
 - Selecting
 - Operating element, 104
 - Service
 - In the Internet, 5
 - Service pack, 274
 - Set up
 - Network, 142

- Password protection, 112
 - Secure mode, 94
- Setting
 - Backlighting, 99
 - Browser, 98
 - Date, 114
 - Date format, 116
 - Date/Time, 98
 - Delay time, 99, 131
 - Device name, 99
 - DIP switch, 70
 - Double-click, 108
 - E-Mail, 99
 - E-mail connection, 148
 - IP address, 98
 - Language, 193
 - MPI, 99, 140
 - Name server, 98
 - Network, 145
 - Number format, 116
 - Operation feedback, 99
 - PC/PPI adapter, 72
 - Power supply, 99
 - Printer connection, 120
 - Printer properties, 98
 - PROFIBUS, 140
 - PROFIBUS DP, 99
 - PROFINET IO, 98
 - Proxy, 98
 - Regional data, 116
 - Screen saver, 119
 - Sound, 124
 - Storage location, 130
 - Time, 114
 - Time format, 116
 - UPS, 132
- Setting language, 193
- Settings
 - Internet, 99
 - Language, 98
 - Regional, 98
 - S7-Transfer, 99
- Shift key, 105
- SHIFT key, 105, 202
- Shutting down
 - HMI device, 78
- Side view, 15, 17, 19, 21, 23
- Siemens HMI input panel options, 98
- Simple alarm view, 240
- Simple recipe view, 251
 - Menu command, 263
 - Operating element, 262
- Simple user view, 226
- Slider control, 214
- Sm@rtAccess, 32
- Sm@rtClient view, 220, 221
 - Monitoring mode, 221
 - Usage, 220
- Sm@rtService, 32
- SMTP server, 148
- Software options, 32
- Sort order
 - Alarm view, 241
- Sound
 - Setting, 99, 124
 - Setting event, 124
- Start
 - HMI device, 98, 125
- Status Force, 216
 - Key control, 219
 - Touch operation, 217
- Storage conditions, 44
- storage device
 - Restoring from external, 155
- Storage device
 - Saving to external, 153
- Storage location
 - Setting, 130
- Strain relief, 79
- Subnet mask, 146
- Supply voltage
 - MP 377, 281
- Support
 - In the Internet, 5
- Support arm system
 - Adapter set CP-L, 27
 - Adapter set PLUS, 27
 - Adapter set VESA 100, 27
 - Adapter set VESA 75, 27
 - Basic adapter, 27
- Switches, 211
- Switching on
 - MP 377, 77
- Symbolic value
 - Editing, 199
 - Entering, 199
- Synchronizing
 - Date and time, 115
 - Recipe tag, 253, 259
- System alarm
 - Meaning, 290
 - Parameters, 289
- System information, 99
 - Displaying, 129
 - LED, 128
- System key, 82

System properties, 99
 Device name, 144
 General, 128
 Memory, 129

T

TAB key, 104, 201
 Tabulator key, 104, 201
 Tags
 Functional scope, 29
 Task planner
 Functional scope, 31
 Taskbar, 89
 TCP/IP address, 145
 Technical specifications
 Display, 280
 Input device, 280
 Interfaces, 281
 Memory, 280
 MP 377, 280
 Supply voltage, 281
 Technical support, 5
 Temporary files
 Backup, 116
 Test
 For ambient conditions, 46
 Test voltage, 52
 Testing
 MP 377, 77
 Text box, 194
 Character mode, 202
 Normal mode, 202
 Text list
 Functional scope, 29
 Time, 98
 Entering, 199, 208
 Setting, 114
 Synchronizing, 115
 Time format, 98, 116
 Time zone
 Setting, 114
 Time-dependent reactions, 115
 Touch operation
 Trend view, 214
 Touch screen
 Calibrating, 98, 110
 Safety instruction, 81
 Trademark, 3
 Training center, 5
 Transfer, 159, 160, 163
 Automatic, 164

Cancel, 77
 Manual, 163
 Transfer mode
 Unintentional, 136
 Via MPI, 139
 Via PROFIBUS DP, 139
 Transfer settings, 99, 136
 Channel, 136
 Directories, 130, 131
 Transferring
 License key, 162, 187
 Project, 159, 162
 Recipe data record, 261, 268
 Transferring back
 License key, 162, 188
 Transport conditions, 44
 Transport damage, 53
 Trend view, 212
 Key control, 214
 Touch operation, 214
 Trends
 Functional scope, 31
 Limit violation, 212

U

UL approval, 40
 Unintentional action, 81, 82, 190
 Unintentional transfer mode, 136
 Update
 Operating system, 173
 Updating
 About ProSave, 176
 using WinCC flexible, 175
 Updating the operating system, 162
 UPS
 Connecting, 67
 Connection graphic, 67
 Setting, 132
 UPS properties
 Configuration, 132
 Current status, 133
 USB
 Connection sequence, 73
 USB connection sequence
 Safety instruction, 73
 USB device
 Connecting, 74
 USB flash drive, 27
 USB memory stick, 27
 Use
 Conditions, 45

- In residential areas, 41
- Industrial, 41
- With additional measures, 45
- User data
 - Backup, 225
 - Changing, 233, 234
 - Restoring, 225
- User group, 224
- User name, 147
- User view, 226
 - Expanded, 226
 - Simple, 226
- Users, 225
 - Admin, 233, 234, 235
 - Changing, 229
 - Creating, key control, 230
 - Delete, 235
 - Logoff, 228
 - Logon, 227
 - PLC_User, 233, 234, 235

V

- Value table
 - Trend view, 213
- VBScript
 - Functional scope, 31

- Volume, 122
 - Setting, 99
- Volume & Sounds Properties, 99

W

- Weight
 - MP 377, 280
- WinCC flexible internet settings
 - E-mail, 148
 - E-Mail, 99
- Windows CE interface
 - Operating, 91
- Windows CE taskbar, 89
 - Password protection, 92
- WINS, 146
 - Server, 142
- Wiring diagram
 - Configuration PC, 71
 - Equipotential bonding, 64
 - PLC, 68
 - Power supply, 65
 - Printer, 75
- Word Viewer, 32
- Working on the control cabinet, 38