

SIEMENS

SIMATIC HMI

HMI device
OP 73micro, TP 177micro
(WinCC flexible)

Operating Instructions

Introduction

Overview

1

Safety instructions and general notes

2

Planning use

3

Mounting and connection

4

Operator control components and LEDs

5

Configuring the operating system

6

Preparing and backing up a project

7

Operating a project

8

Operating alarms

9

Maintenance and servicing

10

Specifications

11

Appendix

A

Abbreviations

B

Order No. 6AV6691-1DF01-0AB0

09/2007

A5E01006740-02

Safety Guidelines

This manual contains notices you have to observe in order to ensure your personal safety, as well as to prevent damage to property. The notices referring to your personal safety are highlighted in the manual by a safety alert symbol, notices referring only to property damage have no safety alert symbol. These notices shown below are graded according to the degree of danger.

⚠ DANGER
indicates that death or severe personal injury will result if proper precautions are not taken.
⚠ WARNING
indicates that death or severe personal injury may result if proper precautions are not taken.
⚠ CAUTION
with a safety alert symbol, indicates that minor personal injury can result if proper precautions are not taken.
CAUTION
without a safety alert symbol, indicates that property damage can result if proper precautions are not taken.
NOTICE
indicates that an unintended result or situation can occur if the corresponding information is not taken into account.

If more than one degree of danger is present, the warning notice representing the highest degree of danger will be used. A notice warning of injury to persons with a safety alert symbol may also include a warning relating to property damage.

Qualified Personnel

The device/system may only be set up and used in conjunction with this documentation. Commissioning and operation of a device/system may only be performed by **qualified personnel**. Within the context of the safety notes in this documentation qualified persons are defined as persons who are authorized to commission, ground and label devices, systems and circuits in accordance with established safety practices and standards.

Prescribed Usage

Note the following:

⚠ WARNING
This device may only be used for the applications described in the catalog or the technical description and only in connection with devices or components from other manufacturers which have been approved or recommended by Siemens. Correct, reliable operation of the product requires proper transport, storage, positioning and assembly as well as careful operation and maintenance.

Trademarks

All names identified by ® are registered trademarks of the Siemens AG. The remaining trademarks in this publication may be trademarks whose use by third parties for their own purposes could violate the rights of the owner.

Disclaimer of Liability

We have reviewed the contents of this publication to ensure consistency with the hardware and software described. Since variance cannot be precluded entirely, we cannot guarantee full consistency. However, the information in this publication is reviewed regularly and any necessary corrections are included in subsequent editions.

(A)

가

Introduction

Purpose of the operating instructions

This operating instruction manual provides information based on the requirements defined by DIN 8418 for mechanical engineering documentation. This information relates to the device, its place of use, transport, storage, installation, use and maintenance.

These operating instructions are intended for:

- Users
- Commissioning engineers
- Service technicians
- Maintenance technicians

Please read the section "Safety instructions and general notes" carefully.

The help integrated in WinCC flexible, the WinCC flexible Information System, contains detailed information. The Information System contains instructions, examples and reference information in electronic form.

Basic knowledge required

General knowledge of automation technology and process communication is needed to understand the operating instructions.

It is also assumed that those using the manual have experience in using personal computers and knowledge of Microsoft operating systems.

Operating instructions' range of validity

The operating instruction manual applies to the OP 73micro and TP 177micro HMI devices in connection with the WinCC flexible software package.

Position in the information landscape

These operating instructions form part of the SIMATIC HMI documentation. The following information provides you with an overview of the SIMATIC HMI information landscape.

User manuals

- WinCC flexible Micro:
Describes basic principles of configuration using the WinCC flexible Micro Engineering System.
- WinCC flexible Compact/Standard/Advanced:
Describes basic principles of configuration using the WinCC flexible Compact Engineering System/WinCC flexible Standard/WinCC flexible Advanced
- WinCC flexible Runtime:
Describes how to commission and operate your runtime project on a PC.
- WinCC flexible Migration:
 - Describes how to convert an existing ProTool project to WinCC flexible.
 - Describes how to convert an existing WinCC project to WinCC flexible.
 - Describes how to convert an existing ProTool project including a change of the HMI device, e.g. from OP7 to OP 77B or OP7 to OP 77B.
 - Describes how to convert an existing ProTool project including a change from a graphics device to a Windows CE device.
- Communication:
 - Communication Part 1 describes the connection of the HMI device to SIMATIC PLCs.
 - Communication Part 2 describes the connection of the HMI device to third-party PLCs.

Operating instructions

- Operating instructions for SIMATIC HMI devices.
 - OP 73micro, TP 177micro
 - OP 73, OP 77A, OP 77B
 - TP 177A
 - TP 170micro, TP 170A, TP 170B, OP 170B
 - Mobile Panel 170
 - TP 270, OP 270
 - MP 270B
 - MP 370
- Operating instructions (compact) for the HMI devices SIMATIC OP 77B and Mobile Panel 170

Getting Started

- WinCC flexible for first time users:
Based on an example project, this is a step-by-step introduction to the basics of configuring screens, alarms, recipes and screen navigation.
- WinCC flexible for advanced users:
Based on an example project, this is a step-by-step introduction to the basics of configuring logs, project reports, scripts, user management and multilingual projects and integration in STEP 7.
- WinCC flexible options:
Based on an example project, this is a step-by-step introduction to the basics of configuring the WinCC flexible Sm@rtServices, Sm@rtAccess and OPC Server options.

Online availability

Technical documentation on SIMATIC products and SIMATIC systems is available in PDF format in various languages at the following addresses:

- SIMATIC Guide Technische Dokumentation in Deutsch:
["http://www.ad.siemens.de/simatic/portal/html_00/techdoku.htm"](http://www.ad.siemens.de/simatic/portal/html_00/techdoku.htm)
- SIMATIC Guide for Technical Documentation in English:
["http://www.ad.siemens.de/simatic/portal/html_76/techdoku.htm"](http://www.ad.siemens.de/simatic/portal/html_76/techdoku.htm)

Conventions

Configuration and runtime software differ with regard to their names as follows:

- "WinCC flexible 2004," for example, refers to the configuration software.
The term "WinCC flexible" is used in a general context. The full name, for example "WinCC flexible 2004", is always used when it is necessary to differentiate between different versions of the configuration software.
- "WinCC flexible Runtime" refers to the runtime software that can run on HMI devices.

Text is highlighted as follows to simplify reading the operating instructions:

Notation	Scope
"Add screen"	<ul style="list-style-type: none"> • Terminology that appears in the user interface, e.g., dialog names, tabs, buttons, menu entries • Inputs required, e.g., limit values, tag values • Path information
"File > Edit"	Operational sequences, e.g., menu commands, context menu commands
<F1>, <Alt+P>	Keyboard operation

Please observe notes labeled as follows:

Note

Notes contain important information concerning the product, its use or a specific section of the documentation to which you should pay particular attention.

Registered trademarks

Names labeled with a ® symbol are registered trademarks of the Siemens AG. Other names used in this documentation may be trademarks, the use of which by third parties for their own purposes could violate the rights of the owner.

- HMI®
- SIMATIC®
- SIMATIC HMI®
- SIMATIC ProTool®
- SIMATIC WinCC®
- SIMATIC WinCC flexible®
- SIMATIC OP 73micro®
- SIMATIC TP 177micro®

Representatives and offices

If you have any further questions relating to the products described in this manual, please contact your local representative at the SIEMENS branch nearest you.

Find your contact partner at:

["http://www.siemens.com/automation/partner"](http://www.siemens.com/automation/partner)

Training center

Siemens AG offers a variety of training courses in order to familiarize you with automation systems. Please contact your regional training center or the central training center in D-90327 Nuremberg, Germany.

Phone: +49 (911) 895-3200

Internet: ["http://www.sitrain.com"](http://www.sitrain.com)

Service & support on the Internet

Service & Support offers online services for additional, comprehensive information on SIMATIC products at

["http://www.siemens.com/automation/support"](http://www.siemens.com/automation/support):

- The newsletter offers you the latest information about your products.
- A large document base is available using our Service & Support search engine.
- A forum for global exchange of information by users and experts
- Current product information, FAQs and downloads
- Your local Automation & Drives representative
- Information about field service, repairs, spare parts and much more under the heading "Services"

Table of contents

	Introduction.....	3
1	Overview.....	11
1.1	Product overview	11
1.2	Design of the OP 73micro HMI device.....	12
1.3	Design of the TP 177micro HMI device	13
1.4	Accessories.....	13
1.5	Miscellaneous	14
1.6	Range of HMI software functions.....	14
1.7	Communication with PLCs.....	16
2	Safety instructions and general notes.....	17
2.1	Safety instructions.....	17
2.2	Standards, Certificates and Approvals	18
2.3	Notes about usage.....	20
2.4	Electromagnetic compatibility	23
2.5	Transport and storage conditions	25
3	Planning use.....	27
3.1	Mounting information	27
3.2	Mounting the OP 73micro	30
3.2.1	Mounting positions and fixation.....	30
3.2.2	Preparing for mounting	31
3.3	Mounting the TP 177micro.....	33
3.3.1	Mounting positions and fixation.....	33
3.3.2	Preparing for mounting	35
3.4	Information on insulation tests, protection class and degree of protection.....	37
3.5	Nominal voltages	38
4	Mounting and connection.....	39
4.1	Checking the package contents.....	39
4.2	Mounting and connecting the OP 73micro.....	39
4.2.1	Mounting the HMI device	39
4.2.2	Connecting the HMI device.....	40
4.2.2.1	Interfaces	41
4.2.2.2	Connecting the equipotential bonding circuit.....	42
4.2.2.3	Connecting the PLC.....	44
4.2.2.4	Connecting the configuration computer	44
4.2.3	Switching on power and testing the HMI device.....	46

4.3	Mounting and connecting the TP 177micro	48
4.3.1	Mounting the HMI device	48
4.3.2	Connecting the HMI device	49
4.3.2.1	Interfaces	50
4.3.2.2	Connecting the equipotential bonding circuit	50
4.3.2.3	Connecting the PLC	53
4.3.2.4	Connecting the configuration computer	53
4.3.3	Switching on power and testing the HMI device	55
4.4	Communication with S7-200	57
4.4.1	Topologies	57
4.4.1.1	Communication via a point-to-point connection	57
4.4.1.2	Communication in the network	58
4.4.1.3	Configuration instructions	60
4.4.2	Configuring communication	60
4.4.2.1	Configuring protocol parameters	61
4.4.3	User data areas	63
4.4.3.1	Communication between HMI device and controller	63
4.4.3.2	Permitted data types	63
4.4.3.3	Time synchronization via area pointer	64
4.4.3.4	Mechanism of error alarm acknowledgment	66
5	Operator control components and LEDs	69
5.1	Front side operator control components and indicators on the OP 73micro	69
5.2	Front side operator control components and LEDs on the TP 177micro	70
6	Configuring the operating system	71
6.1	Configuring the operating system for the OP 73micro	71
6.1.1	Overview	71
6.1.2	"Info/Settings" menu	72
6.1.2.1	Overview	72
6.1.2.2	Setting screen contrast	74
6.1.2.3	Displaying information about the HMI device	74
6.1.2.4	Viewing information about the version of the HMI device image	75
6.1.3	"Settings" menu	75
6.1.3.1	Overview	75
6.1.3.2	Setting the delay	76
6.1.3.3	Setting the screen saver	76
6.1.3.4	Assigning, editing and deleting passwords	77
6.1.3.5	Configure the data channel	79
6.2	Configuring the operating system for the TP 177micro	80
6.2.1	Overview	80
6.2.2	Control Panel	81
6.2.2.1	Overview	81
6.2.2.2	Changing screen settings	82
6.2.2.3	Displaying information about the HMI device	84
6.2.2.4	Calibrating the touch screen	85
6.2.2.5	Changing the password setting for the Control Panel	86
6.2.2.6	Setting the Screen Saver	87
6.2.2.7	Configure the data channel	88
7	Preparing and backing up a project	89
7.1	Overview	89
7.1.1	Setting the operating mode	90
7.1.2	Reusing existing projects	91

7.1.3	Data Transfer Options.....	92
7.2	Transfer.....	92
7.2.1	Overview.....	92
7.2.2	Starting transfer.....	93
7.2.3	Testing a project.....	94
7.3	Backup and restore.....	95
7.3.1	Overview of backup and restoring.....	95
7.3.2	Resetting to Factory Settings for Backup and Restore.....	96
7.3.3	Backup and Restore via WinCC flexible.....	96
7.3.4	Backup and Restore via ProSave.....	98
7.4	Updating the operating system.....	100
7.4.1	Overview.....	100
7.4.2	Updating the operating system using WinCC flexible.....	101
7.4.3	Updating the operating system in ProSave.....	102
8	Operating a project.....	103
8.1	Operating a project on OP 73micro.....	103
8.1.1	Overview.....	103
8.1.2	Setting the project language.....	105
8.1.3	Entries and help within a project.....	105
8.1.3.1	Overview.....	105
8.1.3.2	Entering and Editing Numerical and Alphanumerical Values.....	107
8.1.3.3	Entering and editing symbolic values.....	110
8.1.3.4	Entering and modifying date and time.....	111
8.1.3.5	Viewing infotext.....	112
8.1.4	Project security.....	113
8.1.5	Close the project.....	114
8.2	Operating a project on TP 177micro.....	115
8.2.1	Overview.....	115
8.2.2	Setting the project language.....	116
8.2.3	Entries and help within a project.....	117
8.2.3.1	Overview.....	117
8.2.3.2	Entering and editing numerical values.....	118
8.2.3.3	Entering and editing alphanumerical values.....	120
8.2.3.4	Entering and editing symbolic values.....	121
8.2.3.5	Entering and modifying date and time.....	122
8.2.3.6	Viewing infotext.....	123
8.2.4	Project security.....	124
8.2.5	Close the project.....	125
8.2.6	Operating the Trend View.....	125
8.2.6.1	Overview.....	125
8.2.6.2	Operating the Trend View.....	126
9	Operating alarms.....	127
9.1	Overview.....	127
9.2	Operating alarms on the OP 73micro.....	128
9.2.1	Displaying alarms.....	128
9.2.2	Acknowledging an Alarm.....	131
9.2.3	Editing an Alarm.....	131
9.3	Operating alarms on the TP 177micro.....	132
9.3.1	Displaying alarms.....	132
9.3.2	Acknowledging an Alarm.....	134
9.3.3	Editing an Alarm.....	135

10	Maintenance and servicing	137
10.1	Maintenance and service	137
10.1.1	Cleaning screen	138
10.1.2	Protective membrane	138
10.2	Servicing and spare parts	139
11	Specifications	141
11.1	Dimensional drawings	141
11.1.1	Dimensional drawings, OP 73micro	141
11.1.2	Dimensional drawings, TP 177micro	142
11.2	Specifications	143
11.2.1	Specifications of the OP 73micro	143
11.2.2	Specifications of the TP 177micro	144
11.3	Description of interfaces.....	146
11.3.1	Power supply.....	146
11.3.2	RS485 (IF 1B) on OP 73micro	146
11.3.3	RS 485 (IF 1B) on TP 177micro.....	147
A	Appendix.....	149
A.1	ESD Directives	149
A.2	System alarms	151
B	Abbreviations.....	175
	Glossary	177
	Index.....	183

Overview

1.1 Product overview

Micro Panels OP 73micro and TP 177micro – particularly suitable for SIMATIC S7-200

Our new Micro Panels are tailored to applications with SIMATIC S7-200 Micro PLC and provide operating and monitoring functions for small-scale machines and plants. Short configuration and commissioning times, and their configuration in WinCC flexible form highlights of these panels. In addition, the panels support up to 32 configuration languages and five online languages, including the Asian and Cyrillic character sets.

The mounting dimensions of the Operator Panel OP 73micro with its graphical 3" display unit are compatible with OP3 and TD200.

Touch Panel TP 177micro replaces the Touch Panel TP 070/TP 170micro. It can be mounted vertically to provide additional application. This feature enables its use even when space is restricted.

1.2 Design of the OP 73micro HMI device

Views of the HMI device

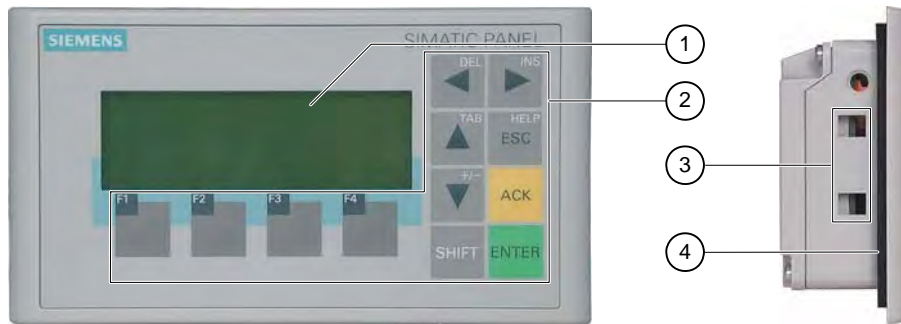

Figure 1-1 Front and side view

- ① Display
- ② Membrane keyboard
- ③ Clamping recess
- ④ Mounting seal



Figure 1-2 Bottom view

1.3 Design of the TP 177micro HMI device

Views of the HMI device

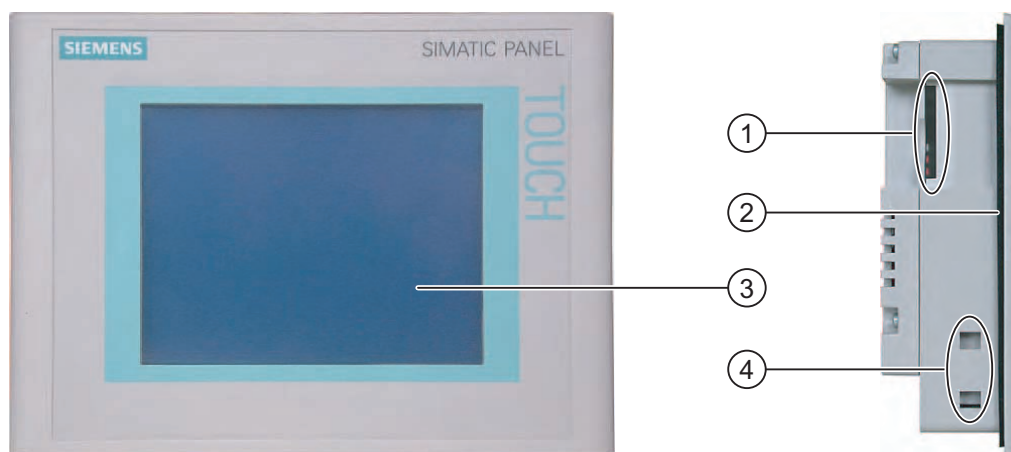

Figure 1-3 Front view and side view

- ① Construction-related opening – not a slot for a memory card
- ② Mounting seal
- ③ Display / Touch screen
- ④ Clamping recess



Figure 1-4 Bottom view

1.4 Accessories

Accessory kit

The accessory kit contains the following:

- A terminal block for the power supply
- Four mounting clamps for installing a TP 177micro
- Two mounting clamps for installing an OP 73

Additional documents may be enclosed with the accessory kit.

1.5 Miscellaneous

PC-PPI adapter

For the conversion from RS 232 to RS 485, order the PC-PPI adapter, Order No. 6ES7 901- 3CB30-0XA0, from Siemens AG. You need the PC-PPI adapter, for example, to update the operating system or to transfer project data.

Protective membrane

A protective membrane is available for TP 177micro, order no. 6AV6 671-2XC00-0AX0.

1.6 Range of HMI software functions

General

The following tables show the objects the user can integrate in a project for an OP 73micro and TP 177micro.

Note

The specified values are maximum values of the individual objects. Simultaneous use of multiple objects with their maximum value can lead to problems in the active project.

Alarms

Table 1-1 Range of functions for alarms

Object	Specification	OP 73micro	TP 177micro
Alarm	Number of discrete alarms	250	500
	Number of analog alarms	5	20
	Length of the alarm text	80 characters	80 characters
	Number of tags in an alarm	Max. 8	Max. 8
	Display	Alarm view, Alarm window	Alarm view, Alarm window
	Acknowledge single error alarms	Yes	Yes
	Acknowledge several error alarms simultaneously (group acknowledgement)	Yes	Yes
	Edit alarm	Yes	Yes
	Alarm indicator	Yes	Yes
Volatile alarm buffer	Alarm buffer capacity	100 alarms	128 alarms
	Simultaneously queued alarm events	Max. 30	Max. 32
	View alarm	Yes	Yes
	Delete alarm buffer	Yes	Yes

Tags, values and lists

Table 1-2 Range of functions for tags, values and lists

Object	Specification	OP 73micro	TP 177micro
Tags	Number	500	250
Limit-value monitoring		Input	Input/Output
Linear Scaling	Input/Output	Yes	Yes
Text lists	Number	150	150

Screens

Table 1-3 Range of functions for screens

Object	Specification	OP 73micro	TP 177micro
Screen	Number	250	250
	Fields per screen	20	20
	Tags per screen	20	20
	Complex objects per screen (e.g. bars)	5	5
	Template	Yes	Yes

Infotext

Table 1-4 Range of functions for infotext

Object	Specification	OP 73micro	TP 177micro
Infotext	Length (no. of characters)	320	320
	For alarms	Yes	Yes
	For screens	Yes	Yes
	For screen objects (e.g. IO fields)	Yes	Yes
	Help indicator	Yes	No

Additional functions

Table 1-5 Range of additional functions

Object	Specification	OP 73micro	TP 177micro
Monitor settings	Contrast	Yes	Yes
	Touch screen calibration	No	Yes
Screen saver	-	Yes	Yes
Language switching	Number of languages	5	5
Graphic object		Graphics	Graphics / vector graphic
Trend views	Number	-	25
Trends per view	Number		4
Text object	Number	2500	500
Password protection	Number of passwords	1	1

1.7 Communication with PLCs

Number of connections

Interconnection	OP 73micro	TP 177micro
Number for MPI/PROFIBUS DP	1	1

Siemens PLCs

The following table shows the Siemens PLCs and protocols or profiles that can be used.

PLC	Protocol / profile	OP 73micro	TP 177micro
S7-200	MPI ¹	yes	yes

¹ If you require a baud rate of 9.6 Kbps, use the "DP" profile in WinCC flexible.

The HMI device can communicate only with one S7-200 at a time. The HMI device can be connected to the S7-200 using a PtP connection or a network.

See also

Communication via a point-to-point connection (Page 57)

Communication in the network (Page 58)

Safety instructions and general notes

2.1 Safety instructions

Working on the cabinet

 WARNING
<p>Open equipment</p> <p>The HMI device is an open equipment. This means that the HMI device may only be installed in cubicles or cabinets, whereby the device can be operated from the front panel.</p> <p>Access to the cubicle or cabinet in which the HMI device is installed should only be possible by means of a key or tool and for personnel who have received instruction or are authorized.</p> <p>Danger, high voltage</p> <p>Opening the cabinet will expose high voltage parts. Contact with these parts could be fatal. Switch off the power supply to the cabinet before opening it.</p>

Hazardous areas

When operating the HMI device in hazardous areas the following warning applies.

 WARNING
<p>Explosion Hazard</p> <p>Do not disconnect while circuit is live unless area is known to be non-hazardous. Substitution of components may impair suitability for Class I, Division 2 or Zone 2.</p>

High frequency radiation

NOTICE
<p>Unintentional operating situations</p> <p>High frequency radiation, from mobile phones for example, can cause unintentional operating situations.</p>

2.2 Standards, Certificates and Approvals

Valid approvals

 CAUTION
Valid approvals The overview below provides information on available approvals The HMI device itself is certified as shown on the label on its rear panel.

CE approval



The automation system meets the general and safety-related requirements of the following EC directives and conforms to the harmonized European standards (EN) for programmable logic controllers published in the official gazettes of the European Union:

- 89/336/EEC "Electromagnetic Compatibility" (EMC guideline)
- 94/9/EG "Equipment and protective systems intended for use in potentially explosive atmospheres" (ATEX).

EC declaration of conformity

The EC declarations of conformity are kept available for the responsible authorities at the following address:

Siemens Aktiengesellschaft
Automation & Drives
A&D AS RD ST PLC
PO Box 1963
D-92209 Amberg

UL certification



Underwriters Laboratories Inc. conforming to

- UL 508 (Industrial Control Equipment)
- CSA C22.2 No. 142, (Process Control Equipment)

or



Underwriters Laboratories Inc. conforming to

- UL 508 (Industrial Control Equipment)
- CSA C22.2 No. 142, (Process Control Equipment)
- UL 1604 (Hazardous Location)
- CSA-213 (Hazardous Location)

Approved for use in

- Class I, Division 2, Group A, B, C, D or
- Class I, Zone 2, Group IIC or
- non-hazardous locations

FM Approval



Factory Mutual Research (FM) conforming to

- Approval Standard Class Number 3611, 3600, 3810

Approved for use in

- Class I, Division 2, Group A, B, C, D T4
- Class I, Zone 2, Group IIC T4

Ex approval



In compliance with EN 50021 (Electrical apparatus for potentially explosive atmospheres;
Type of protection "n")

- II 3 G/D EEx nA II T4
- IP65
- 04 ATEX 1297X

Tick-mark for Australia



The HMI device fulfills the requirements of standard AS/NZS 2064 (Class A).

IEC 61131

The HMI device fulfills the requirements and criteria conforming to IEC 61131-2, Programmable Logic PLCs, Part 2: Operating resource requirements and tests.

2.3 Notes about usage

Use in industry

The HMI device is designed for industrial use. The following standards are met:

- Requirements of the emission of interference EN 61000-6-4: 2001
- Requirements for noise immunity EN 61000-6-2: 2001

Residential use

If the HMI device is used in a residential area, you must take measures to achieve Limit Class B conforming to EN 55011 for RF interference.

Suitable measures to achieve Limit Class B for suppression of radio interference include:

- Installation of the HMI device in a grounded control cabinet
- Use of filters in electrical supply lines

Use in potentially explosive atmosphere, Zone 2



 DANGER
Risk of explosion
Operate the HMI device only in a Zone 2 potentially explosive atmosphere if it has been identified as approved for such environments.



Figure 2-1 Explosion protection label

- II 3 G/D EEx nA II
- IP65
- 04 ATEX 1297X

 WARNING
Personal injury and property damage can occur.
Personal injury and property damage can occur in potentially explosive atmospheres if an electric plug is disconnected from the HMI device while the system is in operation.
In potentially explosive atmospheres, always turn off power to the HMI device before disconnecting any connectors.

Potentially explosive atmosphere, Zone 2

Potentially explosive atmospheres are organized by zones. The zones are classified according to the probability of the presence of an explosive atmosphere.

Zone	Risk of explosion	Example
2	Infrequent and brief development of an explosive gas atmosphere	Areas around flanged pipe joints with flat gaskets in closed rooms
Safe zone	no	<ul style="list-style-type: none"> • Outside Zone 2 • Standard applications of distributed IO

 WARNING
<p>Observe the degree of protection</p> <p>The HMI device must be installed in a metal enclosure or in a cabinet. The minimum degree of protection of these is IP54 (conforming to EN 60529). Make allowances for the ambient conditions under which you install the HMI device. The enclosure must have a manufacturer's declaration for Zone 2 (conforming to EN 50021).</p>

Special conditions for operation in potentially explosive atmospheres of Zone 2

- In situations where the temperature on the cable or at the cable inlet of this enclosure exceeds 70° C or the temperature on the wire branching point exceeds 80° C under operating conditions, the properties of the cables used must ensure that these can withstand the actually measured temperatures.
- The cable inlets must be compliant with the required degree of protection (conforming to 50021.)
- All peripheral devices connected to the HMI device must be certified conforming to explosion protection types EEx nA or EEx nC.
- Measures must be taken to prevent transient voltages from causing the voltage to exceed its nominal value by more than 40%.
- Ambient temperature range: 0° C ... 50° C vertical
- The temperature of the HMI device's cabinet surface should not exceed 60° C.
- The HMI device should be switched off immediately and replaced if damaged.
 - Such damage might be:
 - Tears or detachment of individual membranes
 - A tear in proximity to the viewing window

2.3 Notes about usage

- A label with the following warning must be attached to the inside of the switch cabinet/cubing at a place that is clearly visible upon opening:

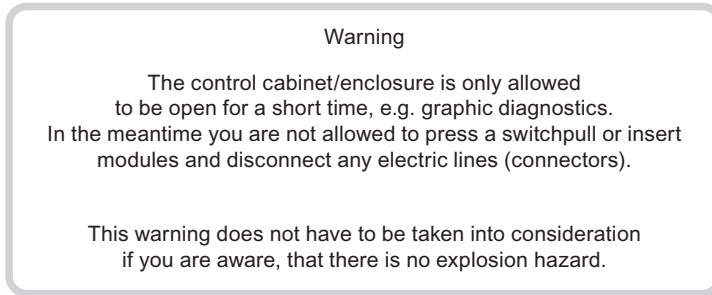

List of approved HMI devices

The list of approved HMI devices is available on the Internet under:

["http://www4.ad.siemens.de/view/cs"](http://www4.ad.siemens.de/view/cs)

under article ID 13702947.

Further information

The "HMI device in potentially explosive atmospheres of Zone 2 and Zone 22" flyer is part of the package and must be complied with.

Maintenance

Defective HMI devices must be returned to the manufacturer for repair. Repair may only be carried out by the manufacturer at his site.

Location of the manufacturer:

Siemens AG
Automation & Drives
Werner-von-Siemens-Straße 50
92224 Amberg
Germany

Approval

Note

HMI devices with approval to II 3 G EEx nA II T4 may only be used on SIMATIC systems of device category 3.

2.4 Electromagnetic compatibility

Introduction

The HMI device fulfills requirements of the EMC Directive of the domestic European market and other requirements.

EMC-compliant installation of HMI devices

An EMC-compliant installation of the HMI device and the use of interference-proof cables form the basis of trouble-free operation. The "Directives for interference-free installation of PLCs" and the "PROFIBUS Networks" manual also apply for the installation of the HMI device.

Pulse-shaped interference

The following table shows the EMC properties of the modules with respect to pulse-shaped interference. A requirement for this is that the HMI device meets the specifications and directives regarding electrical installation.

Table 2-1 Pulse-shaped interference

Pulse-shaped interference	Tested with	Corresponds to test intensity
Electrostatic discharge conforming to IEC 61000-4-2	Air discharge: 8 kV Contact discharge: 4 kV	3
Burst pulses (high-speed transient interference) conforming to IEC 61000-4-4	2 kV power supply cable 2 kV signal cable, > 30 m 1 kV signal cable, < 30 m	3
High-power surge pulses conforming to IEC 61000-4-5, external protective circuit required (refer to S7 300 PLC, Installation, chapter "Lightning and overvoltage protection").		
<ul style="list-style-type: none"> Asymmetric coupling 	2 kV power cable DC voltage with protective elements 2 kV signal/data cable, > 30 m, with protective elements as required	3
<ul style="list-style-type: none"> Asymmetric coupling 	1 kV power cable DC voltage with protective elements 1 kV signal cable, > 30 m, with protective elements as required	3

Sinusoidal interference

The table below shows the EMC properties of the modules with respect to sinusoidal interference. A requirement for this is that the HMI device meets the specifications and directives regarding electrical installation.

Table 2-2 Sinusoidal interference

Sinusoidal interference	Test values	Corresponds to test intensity
RF interference (electromagnetic fields) <ul style="list-style-type: none"> • conforming to IEC 61000-4-3 • conforming to IEC 61000-4-3 	10 V/m with 80 % amplitude modulation of 1 kHz in the range from 80 MHz to 1 GHz and 1.4 GHz to 2 GHz 10 V/m with 50% pulse modulation at 900 MHz 10 V/m with 50% pulse modulation at 1.89 GHz	3
RF interference current on cables and cable shielding conforming to IEC 61000-4-6	Test voltage 10 V with 80% amplitude modulation of 1 kHz in the range from 9 kHz to 80 MHz	3

Emission of radio interference

Emission of electromagnetic interference conforming to 55011, Limit value class A, Group 1, measured at a distance of 10 m:

From 30 to 230 MHz	< 40 dB (V/m) quasi-peak
From 230 to 1000 MHz	< 47 dB (V/m) quasi-peak

Additional measures

Before you connect an HMI device to the public network, ensure that it is compliant with Limit Class B conforming to 55022.

2.5 Transport and storage conditions

Mechanical and climatic transport and storage conditions

The transport and storage conditions of this HMI device exceed requirements conforming to IEC 61131-2. The following specifications apply to the transport and storage of an HMI device in its original packing.

The climatic conditions comply to the following standards:

- IEC 60721-3-3, Class 3K7 for storage
- IEC 60721-3-2, Class 2K4 for transport

The mechanical requirements are compliant with EC 60721-3-2, Class 2M2.

Table 2-3 Transport and storage conditions

Type of condition	Permissible range
Drop test (in transport package)	≤ 1 m
Temperature	from -20° C to +60° C
Atmospheric pressure	from 1080 hPa to 660 hPa, corresponds to an elevation of - 1000 m to 3500 m
Relative humidity	from 10% to 90% without condensation
Sinusoidal vibration conforming to IEC 60068-2-6	5 Hz to 9 Hz: 3.5 mm 9 Hz to 150 Hz: 9.8 m/s ²
Shock conforming to IEC 60068-2-29	250 m/s ² , 6 ms, 1000 shocks

NOTICE

Ensure that no condensation (dewing) develops on or inside the HMI device after transporting it at low temperatures or after it has been exposed to extreme temperature fluctuations.

The HMI device must have acquired room temperature before it is put into operation. Do not expose the HMI device to direct radiation from a heater in order to warm it up. If dewing has developed, wait approximately four hours before you switch on the HMI device.

Prerequisite for the trouble-free and safe operation of the HMI device is proper transport and storage, installation and assembly and careful operation and maintenance.

Warranty for the HMI device is deemed void if these specifications are ignored.

Planning use

3.1 Mounting information

Mechanical and climatic conditions of use

The HMI device is intended for installation in weatherproof permanent locations. The conditions of use are compliant with requirements to DIN IEC 60721-3-3:

- Class 3M3 (mechanical requirements)
- Class 3K3 (climatic requirements)

Use with additional measures

Examples of applications where the use of the HMI device requires additional measures:

- In locations with a high degree of ionizing radiation
- In locations with extreme operating conditions resulting from situations as follows:
 - Corrosive vapors, gases, oils or chemicals
 - Electrical or magnetic fields of high intensity
- In plants requiring special monitoring features, for example:
 - Elevator systems
 - Systems in especially hazardous rooms

Mechanical ambient conditions

The mechanical ambient conditions for the HMI device are specified in the following table in terms of sinusoidal vibration.

Table 3-1 Mechanical ambient conditions

Frequency range in Hz	Continuous	Occasional
$10 \leq f \leq 58$	Amplitude 0.0375 mm	Amplitude 0.075 mm
$58 \leq f \leq 150$	0.5 g constant acceleration	Constant acceleration 1 g

Reduction of vibration

If the HMI device is subjected to greater shocks or vibrations, you must take appropriate measures to reduce acceleration or amplitudes.

We recommend fitting the HMI device to vibration-absorbent material (on metal shock absorbers, for example).

Check of mechanical ambient conditions

The following table provides information on the type and scope of the check of mechanical ambient conditions.

Table 3-2 Check of mechanical ambient conditions

The check includes	Test standard	Remarks
Vibrations	Vibration test conforming to IEC 60068, part 2-6 (sinusoidal)	Type of vibration: Transitional rate of the frequency: 1 octave/minute. $10 \leq f \leq 58$, Constant amplitude 0.075 mm $58 \leq f \leq 150$, Constant acceleration 1 g Vibration duration: 10 frequency cycles per axis in each of the three axes vertical to each other
Shock	Shock test conforming to IEC 60068, part 2-29	Type of shock: Half-sine Shock intensity: Peak value 15 g, duration 11 ms Direction of impact: 3 shocks in \pm direction of axis in each of the three axes vertical to each other

Climatic ambient conditions

The HMI device may be used under the following climatic ambient conditions:

Table 3-3 Climatic ambient conditions

Ambient conditions	Permissible range	Remarks
Temperature <ul style="list-style-type: none"> • Vertical mounting • Inclined mounting 	from 0° C to 50° C from 0 °C to 40 °C	See the "Mounting positions and type of fixation" section
Relative humidity	10% to 90%	Without condensation, corresponds to a relative humidity, stress class 2 conforming to IEC 61131, part 2
Atmospheric pressure	1080 hPa to 795 hPa	Corresponds to an elevation of -1000 to 2000 m
Pollutant concentration	SO ₂ : < 0.5 ppm; relative humidity < 60%, no condensation H ₂ S: < 0.1 ppm; relative humidity < 60 %, no condensation	Test: 10 ppm; 4 days Test: 1 ppm; 4 days

3.2 Mounting the OP 73micro

3.2.1 Mounting positions and fixation

Mounting position

The HMI device is designed for mounting in racks, switch cabinets, switchboards and consoles. In the following, all of these mounting options are referred to by the general term "cabinet."

The HMI device is self-ventilated and approved for vertical and inclined mounting in stationary cabinets.

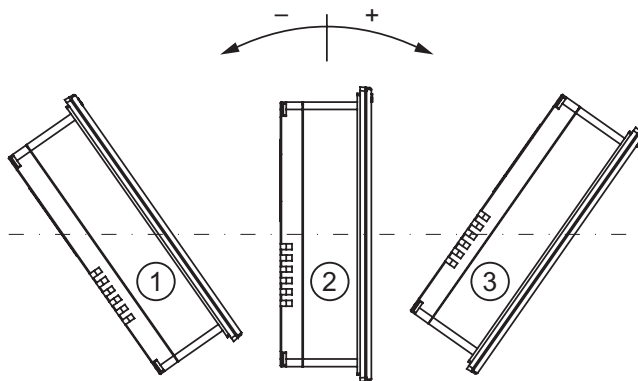

Figure 3-1 Approved deviations from the vertical mounting position of the OP 73micro without auxiliary ventilation

	Mounting position	Deviation from the vertical
①	Inclined	$\leq -80^\circ$
②	Vertical	0°
③	Inclined	$\leq 80^\circ$

CAUTION

Impermissible ambient temperatures

Do not operate the HMI device without auxiliary ventilation if the maximum permissible ambient temperature is exceeded. The HMI device may otherwise get damaged and its approvals and warranty will be void!

Type of fixation

Spring clamps are provided for mounting the device. Hook the clamps into the recesses of the HMI device. The overall HMI device dimensions are not exceeded by this.

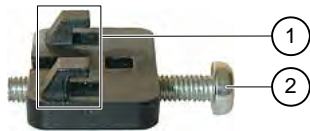

Figure 3-2 View of a mounting clamp

- ① Hook
- ② Recessed head screw

3.2.2 Preparing for mounting

HMI mounting location

What to observe when selecting the mounting location:

- Position the HMI device so that it is not subjected to direct sunlight.
- Position the HMI device to provide an ergonomic position for the operator and select a suitable mounting height.
- Ensure that the air vents are not covered as a result of the mounting.
- Observe the permissible mounting positions for the HMI device.

Preparing the mounting cut-out

The degrees of protection are only guaranteed when the following is observed:

- Material thickness at the mounting cut-out: 2 mm to 4 mm
- The deviation from plane for the panel cut-out is ≤ 0.5 mm.
This condition must be fulfilled for the mounted HMI device.
- Permissible surface roughness in the area of the seal: $\leq 120 \mu\text{m}$ ($R_z 120$)

The figure below shows the required mounting cut-out:

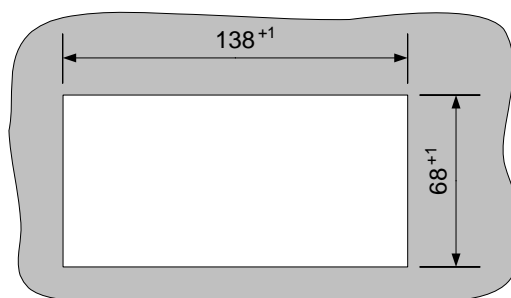

Figure 3-3 Mounting cut-out for OP 73micro

Maintaining clearances

The HMI device must be installed with sufficient clearance:

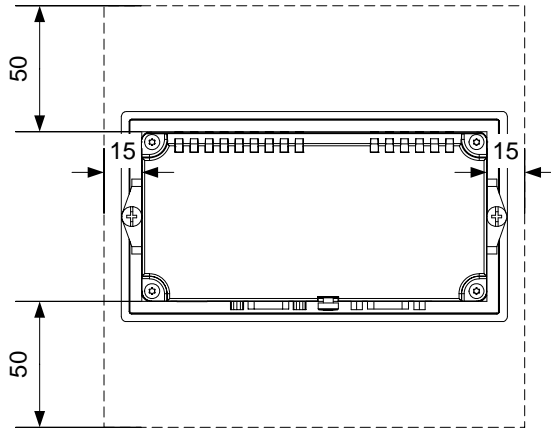

Figure 3-4 Clearance around the OP 73micro

At least 10 mm clearance is required at the rear.

NOTICE
Ensure that the maximum ambient temperature is not exceeded when mounting the device in a cabinet and especially in a closed enclosure.

3.3 Mounting the TP 177micro

3.3.1 Mounting positions and fixation

Mounting position

The HMI device is designed for mounting in racks, cabinets, control boards and consoles. In the following, all of these mounting options are referred to by the general term "cabinet."

The HMI device is self-ventilated and approved for vertical and inclined mounting in stationary cabinets.

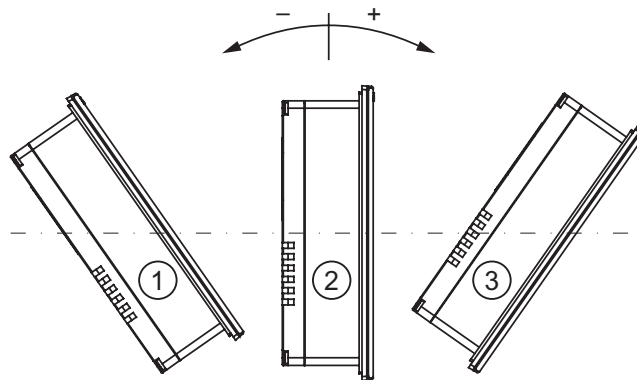

Figure 3-5 Permitted mounting positions

	Mounting position	Deviation from the vertical
①	Inclined	$\leq -35^\circ$
②	Vertical	0°
③	Inclined	$\leq 35^\circ$

CAUTION

Impermissible ambient temperatures

Do not operate the HMI device without auxiliary ventilation if the maximum permissible ambient temperature is exceeded. The HMI device may otherwise get damaged and its approvals and warranty will be void!

Horizontal mounting

When mounted horizontally, the cable inlets are located at the bottom.

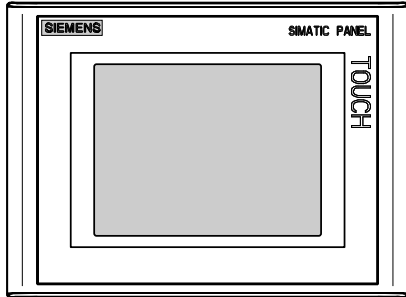

Vertical mounting

When mounted vertically, the cable inlets are on the right.

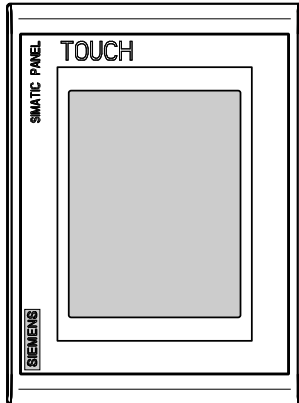

Type of fixation

Spring clamps are provided for mounting the device. Hook the clamps into the recesses of the HMI device. The overall HMI device dimensions are not exceeded by this.

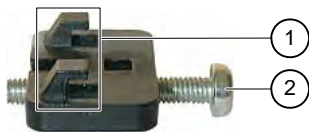

Figure 3-6 View of a mounting clamp

- ① Hook
- ② Recessed head screw

3.3.2 Preparing for mounting

Select the HMI device mounting location

What to observe when selecting the mounting location:

- Position the HMI device so that it is not subjected to direct sunlight.
- Position the HMI device to provide an ergonomic position for the operator and select a suitable mounting height.
- Ensure that the air vents are not covered as a result of the mounting.
- Observe the permissible mounting positions for the HMI device.

Preparing the mounting cut-out

The degrees of protection are only guaranteed when the following is observed:

- Material thickness at the mounting cut-out: 2 mm to 6 mm
- The deviation from plane for the panel cut-out is ≤ 0.5 mm
This condition must be fulfilled for the mounted HMI device.
- Permissible surface roughness in the area of the seal: $\leq 120 \mu\text{m}$ ($R_z 120$)

The figure below shows the required mounting cut-out:

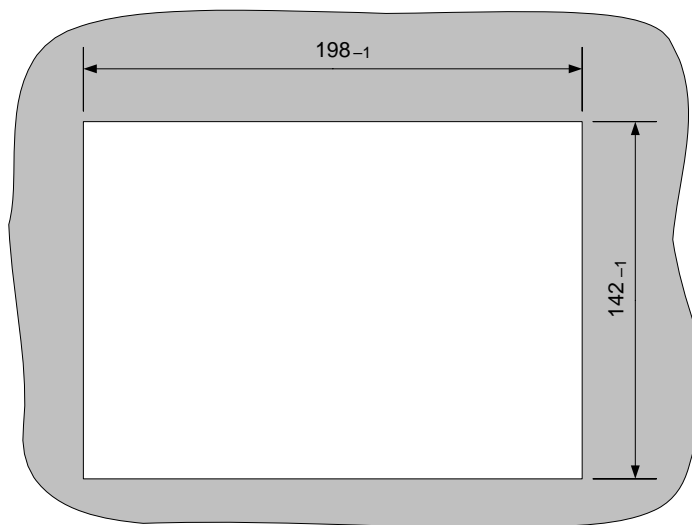

Figure 3-7 Mounting cut-out for the HMI device

Maintaining clearances

The following clearance is required around the HMI device in order to its ensure self-ventilation:

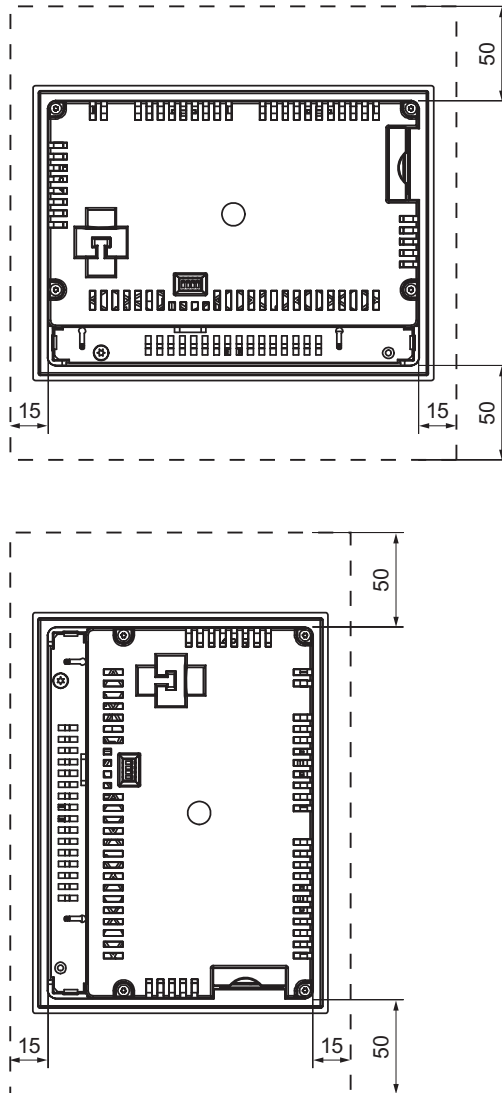

Figure 3-8 Clearance around the HMI device

At least 10 mm clearance is required at the rear.

NOTICE

Ensure that the maximum ambient temperature is not exceeded when mounting the device in a cabinet and especially in a closed enclosure.

3.4 Information on insulation tests, protection class and degree of protection

Test voltages

Insulation strength is demonstrated in the type test with the following test voltages conforming to IEC 61131-2:

Table 3-4 Test voltages

Circuits with a nominal voltage of U_n to other circuits or ground	Test voltage
< 50 V	500 V DC

Class of protection

Protection Class I conforming to IEC 60536, i.e. grounding conductor to profile rail required!

Protection from foreign objects and water

Degree of protection conforming to IEC 60529	Explanation
Front panel Rear panel	IP65 in mounted state IP20 protection against contact with standard test probes There is no protection against ingress by water.

The degree of protection provided by the front side can only be guaranteed when the mounting seal lies completely against the mounting cut-out.

NOTICE
<p>Degree of protection IP65</p> <p>The degrees of protection are only guaranteed when the following is observed:</p> <ul style="list-style-type: none"> • The material strength at the mounting cut-out is at least 2 mm. • The deviation from the plane of the mounting cut-out in an installed HMI device is ≤ 0.5 mm.

3.5 Nominal voltages

The following table shows the permitted nominal voltage and the corresponding tolerance range.

Table 3-5 Permitted nominal voltages

Nominal voltage	Tolerance range
+24 V DC	20.4 V to 28.8 V (-15%, +20%)

Mounting and connection

4.1 Checking the package contents

Check the package contents for visible signs of transport damage and for completeness.

NOTICE
Do not install parts damaged during shipment. In the case of damaged parts, contact your Siemens representative.

Keep the supplied documentation in a safe place. The documentation belongs to the HMI device and is required for subsequent commissioning.

4.2 Mounting and connecting the OP 73micro

4.2.1 Mounting the HMI device

Requirements

Two mounting clamps from the accessories are required for installation. The mounting seal must be available on the HMI device. If the mounting seal is damaged, order a replacement seal.

Mounting

NOTICE
Always mount the HMI device according to the instructions in this manual.

Proceed as follows:

1. Check that the mounting seal is fitted on the HMI device.
Do not install the mounting seal turned inside out. This may cause leaks in the mounting cut-out.
2. Insert the HMI device into the mounting cut-out from the front.
3. Insert the mounting clamps into the recesses on the side of the HMI device.
Adjust and then fasten the clamps.

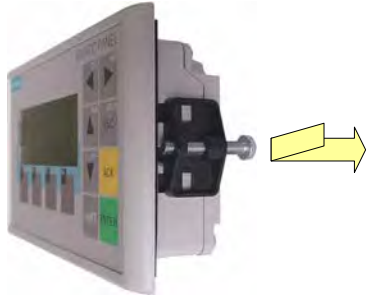

Figure 4-1 Insert the mounting clamp on the OP 73micro.

4. Tighten the clamps by screwing down the recessed head screw; permitted torque: 0.15 N/m.

NOTICE
Check the fit of the mounting seal on the front. The mounting seal must not protrude from the HMI device. Otherwise, repeat steps 1 to 4.

4.2.2 Connecting the HMI device

Requirements

The HMI device must be mounted according to the specifications of these operating instructions.

Connection sequence

Connect the HMI device in the following sequence:

1. Equipotential bonding
2. Power supply
Perform a power-up test to ensure that the correct polarity of the supply voltage.
3. PLC/configuration computer as necessary

NOTICE

Connection sequence

Always follow the correct sequence for connecting the HMI device. Failure to do so may result in damage to the HMI device.

Connecting the cables

When connecting the cables, ensure that you do not bend any of the contact pins.

Secure the connectors with screws.

Always use shielded data cable. Always use standard cables. For further information, refer to the SIMATIC HMI Catalog ST 80.

The pin assignment of the interfaces is described in the specifications.

See also

Safety instructions (Page 17)

4.2.2.1 Interfaces

The figure below shows the interfaces of the HMI device.

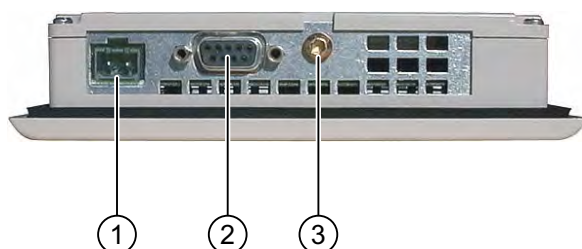

Figure 4-2 Interfaces of the HMI device

- ① Power supply connector
- ② RS 485 interface (IF 1B)
- ③ Chassis ground terminal

See also

Power supply (Page 146)

RS485 (IF 1B) on OP 73micro (Page 146)

4.2.2.2 Connecting the equipotential bonding circuit

Potential differences

Differences in potential between spatially separated system parts can lead to high equalizing currents over the data cables and therefore to the destruction of their interfaces. This situation may arise if the cable shielding is terminated at both ends and grounded at different system parts.

Potential differences may develop when a system is connected to different mains.

General requirements of equipotential bonding

Potential differences must be reduced by means of equipotential bonding in order to ensure trouble-free operation of the relevant components of the electronic system. The following must therefore be observed when installing the equipotential bonding circuit:

- The effectiveness of equipotential bonding increases as the impedance of the equipotential bonding conductor decreases or as its cross-section increases.
- If two system parts are connected to each other via shielded data lines with shielding connected to the grounding/protective conductor on both sides, the impedance of the additionally installed equipotential bonding cables may not exceed 10% of the shielding impedance.
- The cross-section of a selected equipotential bonding conductor must be capable of handling the maximum equalizing current. The best results for equipotential bonding between two cabinets were achieved with a minimum conductor cross-section of 16 mm².
- Use equipotential bonding conductors made of copper or galvanized steel. Establish a large-surface contact between the equipotential bonding conductors and the grounding/protective conductor and protect these from corrosion.
- Terminate the shielding of the data cable on the HMI device flush and near the equipotential busbar using suitable cable clamps.
- Route the equipotential bonding conductor and data cables in parallel with minimum clearance between these. See the wiring diagram.

NOTICE
Equipotential bonding conductor Cable shielding is not suitable for equipotential bonding. Always use the prescribed equipotential bonding conductors. The minimum cross-section of a conductor used for equipotential bonding is 16 mm ² . When you install MPI and PROFIBUS DP networks, always use cables with a sufficient crosssection since otherwise the interface modules may be damaged or destroyed.

Wiring diagram

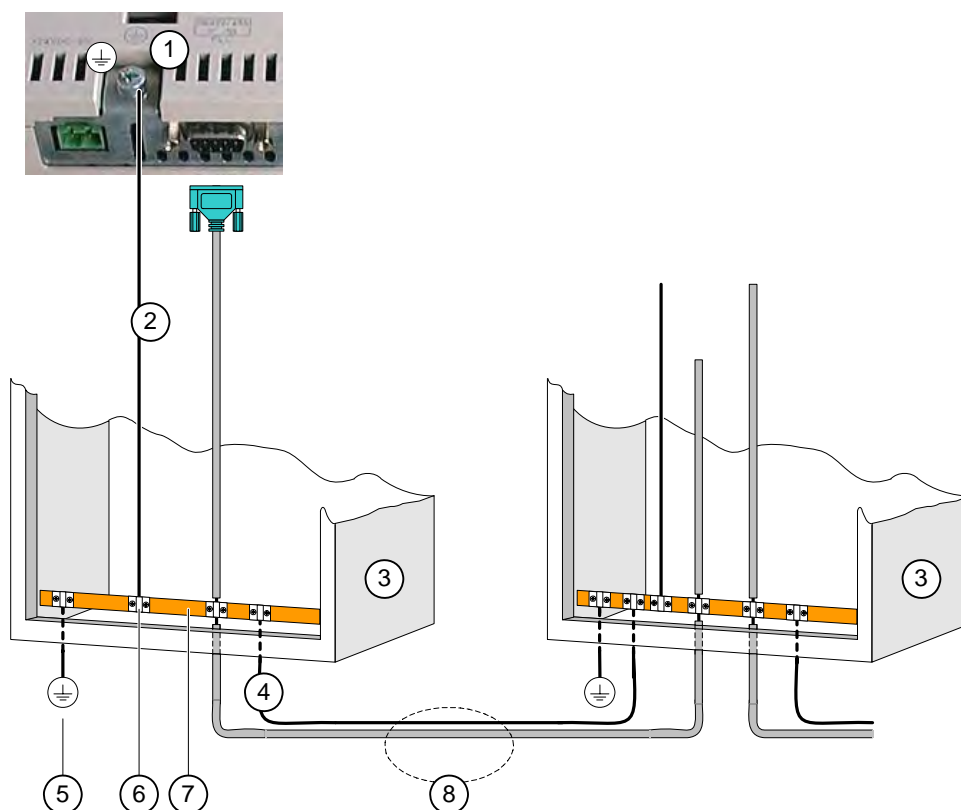

Figure 4-3 Installing the equipotential circuit

- ① Chassis ground terminal on the HMI device (example)
- ② Equipotential bonding conductor cross-section: 4 mm²
- ③ Cabinet
- ④ Equipotential bonding conductor cross-section: min. 16 mm²
- ⑤ Ground terminal
- ⑥ Cable clamp
- ⑦ Voltage bus
- ⑧ Parallel routing of the equipotential bonding conductor and data cable

See also

Electromagnetic compatibility (Page 23)

4.2.2.3 Connecting the PLC

Wiring diagram

The following diagram illustrates the connection between the HMI device and PLC.

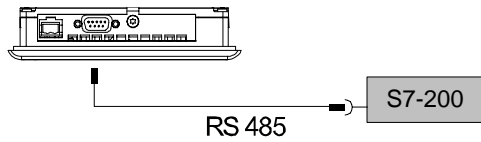

Figure 4-4 Connection to the PLC

The interfaces are described in the Specifications section.

Note when connecting

NOTICE
Always use the approved cables to connect a SIMATIC S7 PLC.

Standard cables are available for the connection. For further information, refer to the SIMATIC HMI Catalog ST 80.

See also

Communication via a point-to-point connection (Page 57)

Communication in the network (Page 58)

Interfaces (Page 41)

4.2.2.4 Connecting the configuration computer

Wiring diagram

The figure below illustrates the connection between the HMI device and configuration computer.

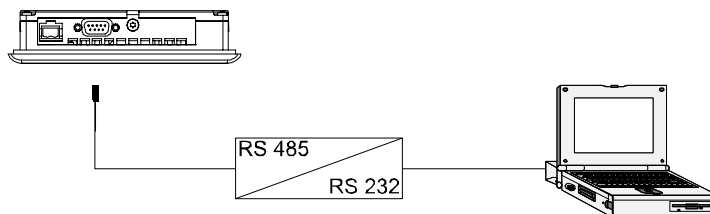

Figure 4-5 Connecting the configuration computer

The interfaces are described in the Specifications section.

See also

Interfaces (Page 41)

Wiring diagram

The figure below illustrates the connection between the power supply and the HMI device.

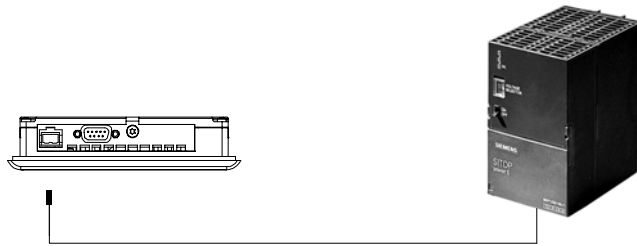

Figure 4-6 Connecting the power supply

The interfaces are described in the Specifications section.

Note when connecting

The power terminal block is included in the assembly kit and is designed for conductors with a maximum cross-section of 1.5 mm².

Connecting the terminal block

NOTICE
Damage Pressure on the screwdriver may damage the HMI device socket if the terminal block is plugged in when you tighten the screws. Always remove the terminal block to connect the wires.

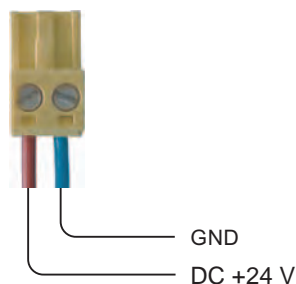

Figure 4-7 Connecting the terminal block

Connect the power supply cables to the terminal block as shown in the figure above. Ensure that the cables are not crossed. Refer to the label showing the pin-out on the rear of the HMI device.

Polarity reversal protection

The HMI device is equipped with a polarity reversal protection circuit.

Connecting the power supply

CAUTION
Ensure safe electrical insulation of the power supply. Always use power supply modules that conform to IEC 364-4-41 or HD 384.04.41 (VDE 0100, Part 410).
Always use power supply modules that comply to SELV (Safety Extra-Low Voltage) and PELV (Protective Extra Low Voltage) standards.
The power supply voltage must always be within the specified range to prevent malfunctions on the HMI device.
Equipotential bonding
Therefore, wire the 24 V output of the power supply to the equipotential circuit.

See also

Interfaces (Page 41)

4.2.3 Switching on power and testing the HMI device

Procedure – Switching on power and testing the HMI device

Proceed as follows:

1. Plug the terminal block into the HMI device.
2. Switch on the power supply.

After power on, the display lights up and the following dialog appears briefly:

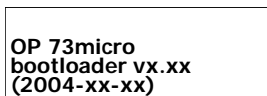

Figure 4-8 Bootloader display

If the HMI device does not start, it is possible the wires on the terminal block have been crossed. Check the connected wires and change the connections if necessary. The Loader opens once the operating system has started.

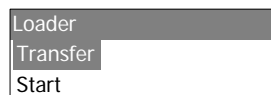

Figure 4-9 Loader view

The HMI device automatically sets transfer mode during initial startup if it does not contain any project data yet. The following dialog appears:

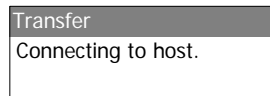



Figure 4-10 "Transfer" dialog

3. Press  to cancel the transfer.

Result

The Loader appears again.





Note

When restarting the system, a project may already be loaded on the HMI device. The system then skips transfer mode and starts the project.

Use the relevant operator control object to close the project.

Further information on this may be available in your plant documentation.

Navigating in the Loader

Button	Action
 or 	Press one of these cursor keys to select the next entry in arrow direction.
	<ul style="list-style-type: none"> • The input is confirmed. • The submenu or dialog shown below opens.
	<ul style="list-style-type: none"> • Move back <p>Returns to the next higher menu layer.</p> <ul style="list-style-type: none"> • Cancel transfer mode

Function test

Perform a function test following commissioning. The HMI device is fully functional when one of the following states is indicated:

- The "Transfer" dialog is displayed.
- The Loader is displayed.
- A project is started.

Switching off the HMI device

Options for switching off the HMI device:

- Switch off the power supply.
- Disconnect the terminal block from the HMI device.

4.3 Mounting and connecting the TP 177micro

4.3.1 Mounting the HMI device

Requirements

Four mounting clamps from the kit are needed to mount the the HMI device. The mounting seal must be available on the HMI device. If the mounting seal is damaged, order a replacement seal. The mounting seal is part of the associated service pack.

Mounting

NOTICE
Always mount the HMI device according to the instructions in this manual.

Proceed as follows:

1. Check that the mounting seal is fitted on the HMI device.
Do not install the mounting seal turned inside out. This may cause leaks in the mounting cut-out.
2. Insert the HMI device into the mounting cut-out from the front.
3. Insert the mounting clamps into the recesses on the side of the HMI device.
Insert and then fasten all four clamps.



Figure 4-11 Installing the mounting clamp on the HMI device

4. Tighten the clamp by screwing down the recessed head screw; permitted torque: 0.15 Nm.

NOTICE

Check the fit of the mounting seal on the front. The mounting seal must not protrude from the HMI device.

Otherwise, repeat steps 1 to 4.

4.3.2 Connecting the HMI device

Requirements

The HMI device must be mounted according to the specifications of these operating instructions.

Connection sequence

Connect the HMI device in the following sequence:

1. Equipotential bonding
2. Power supply

Perform a power-up test to ensure that the correct polarity of the supply voltage.

3. PLC/configuration computer as necessary

NOTICE

Connection sequence

Always follow the correct sequence for connecting the HMI device. Failure to do so may result in damage to the HMI device.
--

Connecting the cables

When connecting the cables, ensure that you do not bend any of the contact pins.

Secure the connectors with screws.

Always use shielded data cable. Always use standard cables. For further information, refer to the SIMATIC HMI Catalog ST 80.

The pin assignment of the interfaces is described in the specifications.

See also

Safety instructions (Page 17)

4.3.2.1 Interfaces

The figure below shows the interfaces of the HMI device.

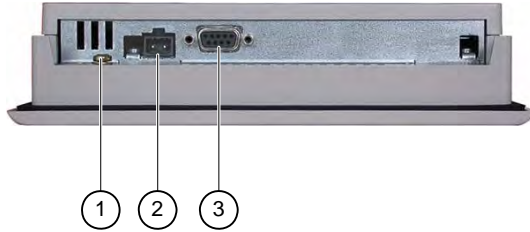

Figure 4-12 Interfaces of the HMI device

- ① Chassis ground terminal
- ② Power supply connector
- ③ RS 485 interface (IF 1B)

See also

Power supply (Page 146)

RS 485 (IF 1B) on TP 177micro (Page 147)

4.3.2.2 Connecting the equipotential bonding circuit

Potential differences

Differences in potential between spatially separated system parts can lead to high equalizing currents over the data cables and therefore to the destruction of their interfaces. This situation may arise if the cable shielding is terminated at both ends and grounded at different system parts.

Potential differences may develop when a system is connected to different mains.

General requirements of equipotential bonding

Potential differences must be reduced by means of equipotential bonding in order to ensure trouble-free operation of the relevant components of the electronic system. The following must therefore be observed when installing the equipotential bonding circuit:

- The effectiveness of equipotential bonding increases as the impedance of the equipotential bonding conductor decreases or as its cross-section increases.
- If two system parts are connected to each other via shielded data lines with shielding connected to the grounding/protective conductor on both sides, the impedance of the additionally installed equipotential bonding cables may not exceed 10% of the shielding impedance.
- The cross-section of a selected equipotential bonding conductor must be capable of handling the maximum equalizing current. The best results for equipotential bonding between two cabinets were achieved with a minimum conductor cross-section of 16 mm².
- Use equipotential bonding conductors made of copper or galvanized steel. Establish a large-surface contact between the equipotential bonding conductors and the grounding/protective conductor and protect these from corrosion.
- Terminate the shielding of the data cable on the HMI device flush and near the equipotential busbar using suitable cable clamps.
- Route the equipotential bonding conductor and data cables in parallel with minimum clearance between these. See the wiring diagram.

NOTICE

Equipotential bonding conductor

Cable shielding is not suitable for equipotential bonding. Always use the prescribed equipotential bonding conductors. The minimum cross-section of a conductor used for equipotential bonding is 16 mm². When you install MPI and PROFIBUS DP networks, always use cables with a sufficient crosssection since otherwise the interface modules may be damaged or destroyed.

Wiring diagram

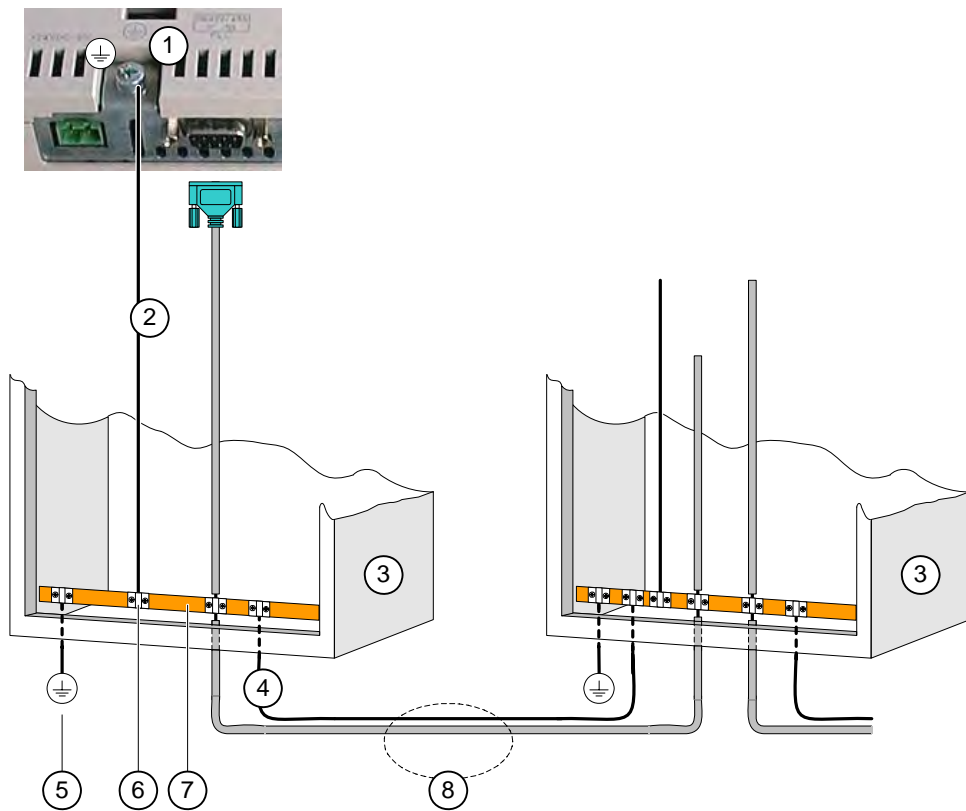

Figure 4-13 Installing the equipotential circuit

- ① Chassis ground terminal on the HMI device (example)
- ② Equipotential bonding conductor cross-section: 4 mm²
- ③ Cabinet
- ④ Equipotential bonding conductor cross-section: min. 16 mm²
- ⑤ Ground terminal
- ⑥ Cable clamp
- ⑦ Voltage bus
- ⑧ Parallel routing of the equipotential bonding conductor and data cable

4.3.2.3 Connecting the PLC

Wiring diagram

The following diagram illustrates the connection between the HMI device and PLC.

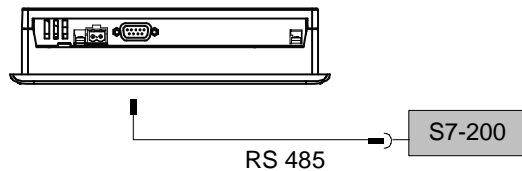

Figure 4-14 Connecting the PLC

The interfaces are described in the Specifications section.

Note when connecting

NOTICE
Always use the approved cables to connect a SIMATIC S7 PLC.

Standard cables are available for the connection. For further information, refer to the SIMATIC HMI Catalog ST 80.

See also

Communication via a point-to-point connection (Page 57)

Communication in the network (Page 58)

Interfaces (Page 50)

4.3.2.4 Connecting the configuration computer

Wiring diagram

The figure below illustrates the connection between the HMI device and configuration computer.

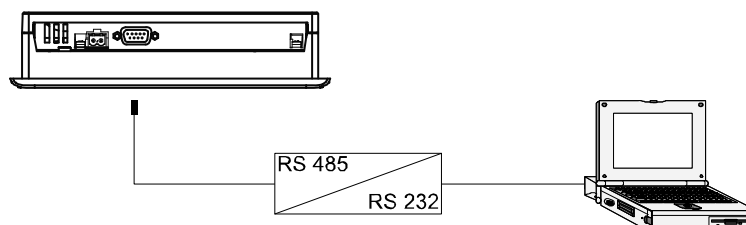

Figure 4-15 Connecting the configuration computer

The interfaces are described in the Specifications section.

See also

Interfaces (Page 50)

Wiring diagram

The figure below illustrates the connection between the power supply and the HMI device.

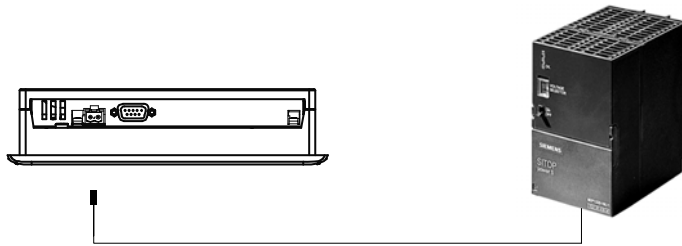

Figure 4-16 Connecting the power supply

Note when connecting

The power terminal block is included in the assembly kit and is designed for conductors with a maximum cross-section of 1.5 mm².

Connecting the terminal block

NOTICE
Damage Pressure on the screwdriver may damage the HMI device socket if the terminal block is plugged in when you tighten the screws. Always remove the terminal block to connect the wires.

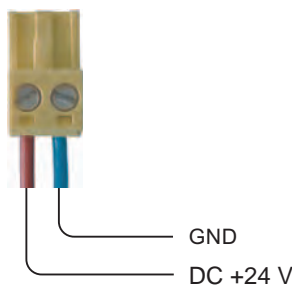

Figure 4-17 Connecting the terminal block

Connect the power supply cables to the terminal block as shown in the figure above. Ensure that the cables are not crossed. Refer to the label showing the pin-out on the rear of the HMI device.

Polarity reversal protection

The HMI device is equipped with a polarity reversal protection circuit.

Connecting the power supply

CAUTION

Ensure safe electrical insulation of the power supply. Always use power supply modules that conform to IEC 364-4-41 or HD 384.04.41 (VDE 0100, Part 410).

Always use power supply modules that comply to SELV (Safety Extra-Low Voltage) and PELV (Protective Extra Low Voltage) standards.

The power supply voltage must always be within the specified range to prevent malfunctions on the HMI device.

Equipotential bonding

Therefore, wire the 24 V output of the power supply to the equipotential circuit.

See also

Interfaces (Page 50)

4.3.3 Switching on power and testing the HMI device

Procedure

Proceed as follows:

1. Plug the terminal block into the HMI device.
2. Switch on the power supply.

The display lights up after power on. A progress bar is shown during startup.

If the HMI device does not start, it is possible the wires on the terminal block have been crossed. Check the connected wires and change the connections if necessary. The Loader opens once the operating system has started.

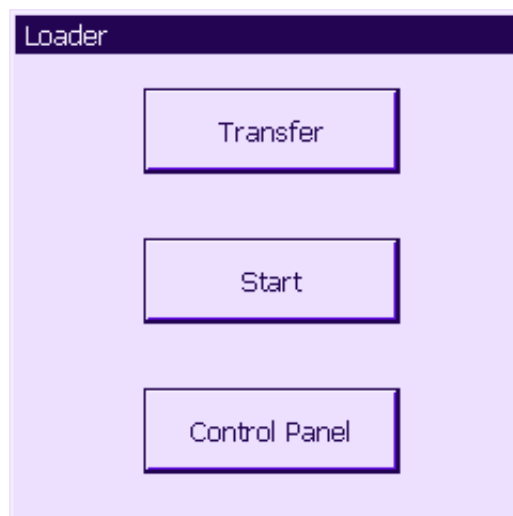

Figure 4-18 Loader view

The HMI device automatically switches to "Transfer" mode during initial startup if no project is already loaded on the device. The following dialog appears:

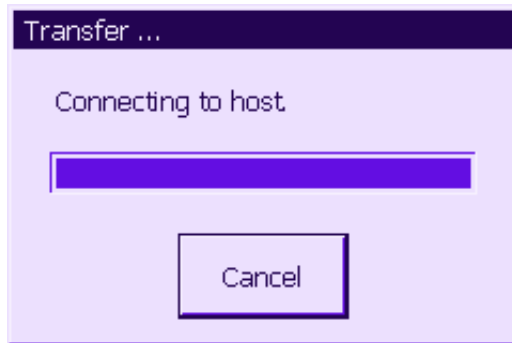

Figure 4-19 "Transfer" dialog

3. Touch "Cancel" to stop the transfer.

Result

The Loader appears again.

Note

When restarting the system, a project may already be loaded on the HMI device. The system then skips "Transfer" mode and starts the project.

Use the relevant operator control object to close the project.

Further information on this may be available in your plant documentation.

Function test

Perform a function test following commissioning. The HMI device is fully functional when one of the following states is indicated:

- The "Transfer" dialog is displayed.
- The Loader is displayed.
- A project is started.

Switching off the HMI device

Options for switching off the HMI device:

- Switch off the power supply.
- Disconnect the terminal block from the HMI device.

4.4 Communication with S7-200

Introduction

This section is intended for configuration engineers of the HMI device.

The following chapter contains information necessary for configuring:

- Connection options to the PLC
- Communication using WinCC flexible

4.4.1 Topologies

Introduction

The HMI device and PLC can communicate using a PtP connection or within a network.

The HMI device can communicate only with one S7-200 at a time.

4.4.1.1 Communication via a point-to-point connection

In a PtP connection, the HMI device is the only device which is connected directly with the S7-200. You need an MPI cable or a PROFIBUS bus cable with two PROFIBUS bus connection plugs to connect the HMI device to the PLC.

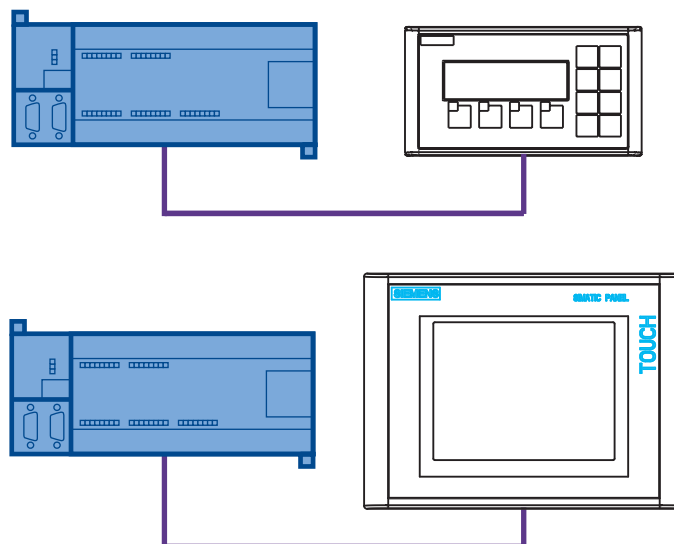

Figure 4-20 Point-to-point connection

See also

Connecting the PLC (Page 44)

Connecting the PLC (Page 53)

4.4.1.2 Communication in the network

Introduction

A network consists of several nodes which are connected to the same bus cable and communicate with each other. All nodes are assigned a unique network address. Which devices communicate with each other is defined when the devices are configured.

A network must contain a master station and active nodes and may contain slave stations and passive nodes. The master actively transmits requests to other devices and can also respond to requests from other masters. A slave only responds to requests.

You need a PROFIBUS bus cable with PROFIBUS bus connector to install a network.

The HMI device always operates as master station.

The HMI device can communicate only with one S7-200 within the network.

S7-200 as active or passive node

The S7-200 station may be operated on the network in master mode (PPI/master mode) and in slave mode (PPI/slave mode). The default setting of the S7-200 station is PPI/slave mode.

The OP 73micro and TP 177micro can communicate with a SIMATIC S7-200 in PPI/slave mode and with a SIMATIC S7-200 in PPI/master mode. The HMI device can be connected via the CPU interface of the SIMATIC S7-200.

Configuration example:

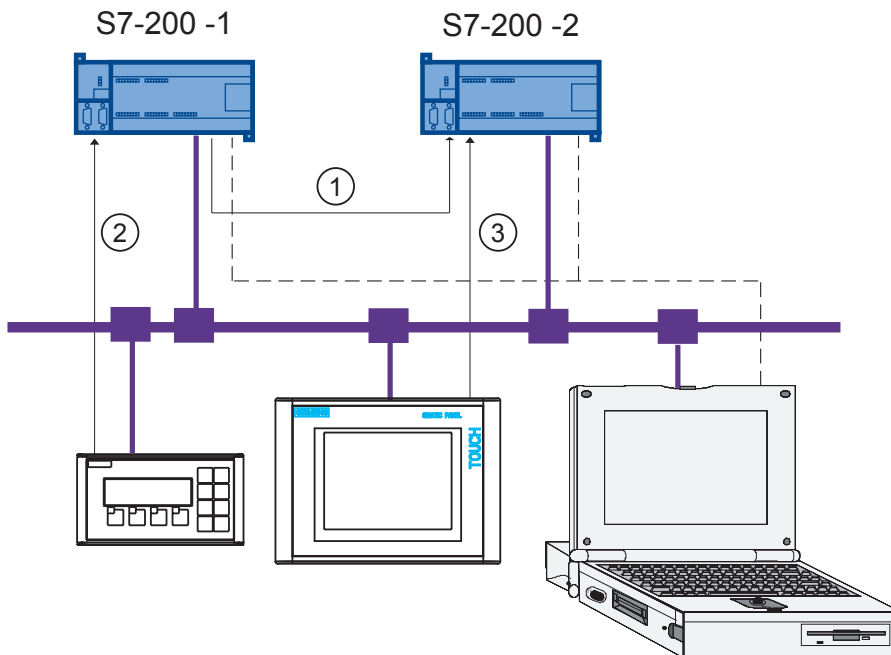

Figure 4-21 Configuration example for communication in the network

- ① The active S7-200-1 (in PPI/master mode) outputs requests to the S7-200-2 station.
- ② OP 73micro communicates with the S7-200-1 in PPI/master mode.
- ③ TP 177micro communicates with the S7-200-2 in PPI/slave mode.
- ④ PG to S7-200-1 or S7-200-2, for example, with control tags

Several HMI devices on one S7-200

An S7-200 PLC supports the connection of up to three HMI devices per CPU interface. The DP interface of a CPU215-2DP supports the connection of up to five HMI devices.

Configuration example:

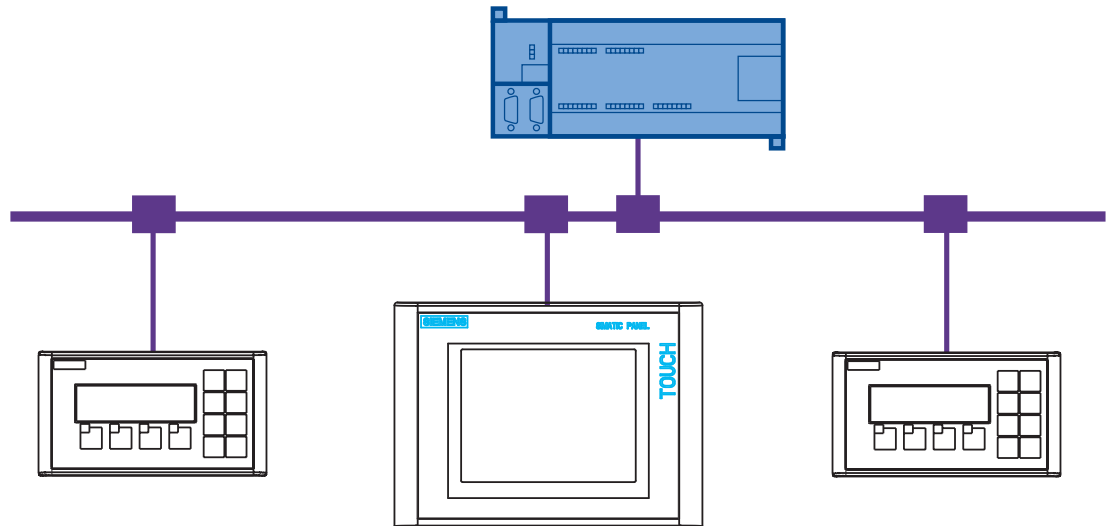

Figure 4-22 Three HMI devices on one S7-200

See also

Connecting the PLC (Page 44)

Connecting the PLC (Page 53)

4.4.1.3 Configuration instructions

Please observe the following configuration instructions:

Note

For a first-generation SIMATIC S7-200 (CPU 214, 215, 216), use the connection at Port 1 for communication via MPI/PROFIBUS DP. When using a CPU 214, set a baud rate of 9.6 Kbps.

Note

A cable must be terminated with its characteristic wave impedance. To do this, enable the terminating resistor on the first and last node of the PROFIBUS/MPI network.

Both nodes must be supplied with power. Of the first and last end nodes of a PROFIBUS/MPI network, only one can be an HMI device! No other HMI devices should be connected to the network as terminal nodes.

The RS485 PROFIBUS terminal and the PROFIBUS connector are equipped with a switch for setting the terminating resistor. Meaning of the ON and OFF switch settings:

OFF: The terminating resistor is disabled, i.e. the bus segment is not terminated.

ON: The terminating resistor is enabled, i.e. the bus segment is terminated.

4.4.2 Configuring communication

Requirements

The following software components are required for communication:

- WinCC flexible configuration software
- STEP 7 MicroWIN configuration software for the SIMATIC S7-200 controller

Driver for the HMI device

The communication driver for S7-200 is supplied with WinCC flexible are installed automatically.

No special blocks are required in the PLC.

4.4.2.1 Configuring protocol parameters

Parameters to be set

To set the parameters, double-click "Communication ► Connections" in the WinCC flexible project screen of the HMI device. From the "Communications driver" column of the working area, select the value "SIMATIC S7-200." Then system automatically writes the default values of the protocol parameters to the properties dialog. You can now customize the protocol parameters of your configuration:

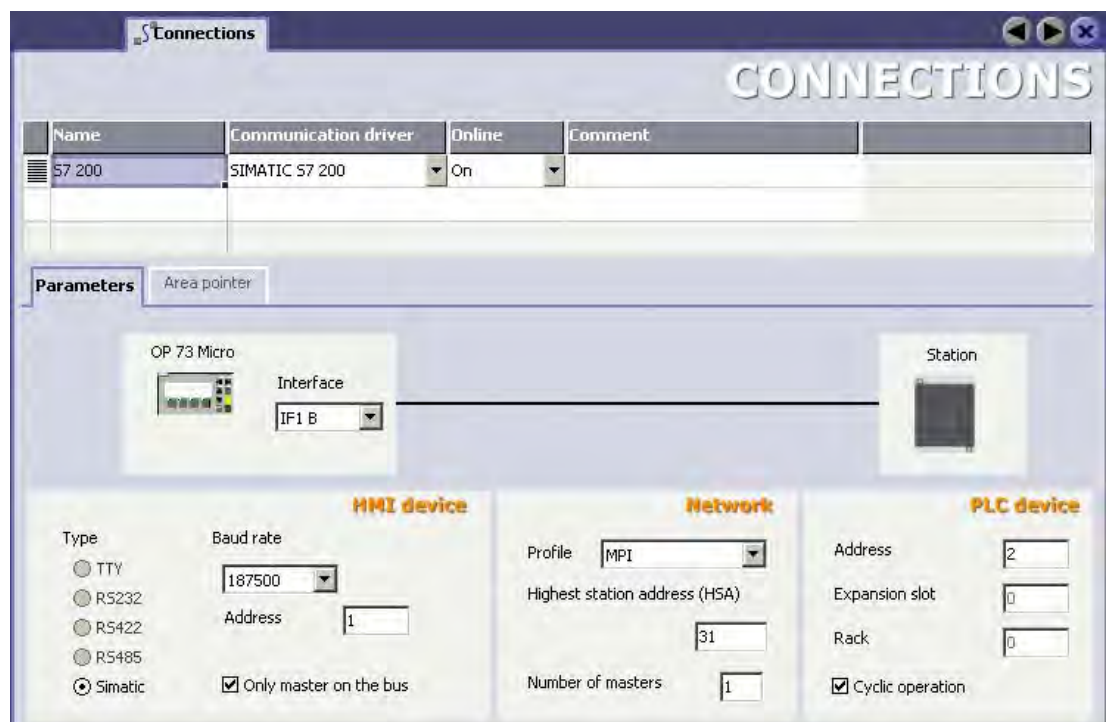

Figure 4-23 Creating an S7-200 connection

Device-specific parameters

Set the network parameters for the HMI device under "HMI device." The setting applies to all communication partners.

- "Interface"
Select the IF1 B interface.

- "Baudrate"
Set the data baud rate for the network here. The baud rate is determined by the slowest HMI device connected to the network. Possible baud rates for the HMI devices OP 73micro and TP 177micro:
 - 9.6 Kbps
 - 19.2 Kbps
 - 187.5 KbpsThe setting must be identical throughout the network.
- "Address"
Set the address of the HMI device here. The address must be unique within the network.
- "Only master on the bus"
na

Network parameters

In the "Network" tab, set the parameters of the network which contains the HMI device.

- "Profile"
Set "MPI" here.
Select "DP" if you need a baud rate of 9.6 Kbps.
- "Highest station address"
Set the highest station address. The highest station address must be equal to or higher than the highest actual address. The setting must be identical throughout the network.
- "Number of masters"
Set the number of masters operating in the network. HMI devices must be operated in master mode. The S7-200 may be operated in master mode.

Communication partners

Under "PLC", assign an address to the S7-200 which is to communicate with the HMI device.

- "Address"
Here, set the address of the S7 module (CPU) that is connected to the HMI device.
- "Slot"
This parameter is not necessary.
- "Rack"
This parameter is not necessary.
- "Cyclic operation"
This parameter is not necessary.

Addressing the SIMATIC S7 PLC

The address of your S7-200 PLC is configured using the STEP 7 MicroWIN tool.

4.4.3 User data areas

4.4.3.1 Communication between HMI device and controller

Communication principle

The HMI device and the S7-200 controller communicate using

- tags and
- user data areas

Tags

The controller and the HMI device exchange data using process values. During configuration, tags are created pointing to addresses in the PLC. The HMI device reads the value from the specified address and displays it. The operator can also make an input on the HMI device that is then written to the address on the controller.

user data areas

In the case of the OP 73micro and TP 177micro, the user data area serves for transmitting the date and time from the PLC to the HMI device.

User data areas are set up when you create the project in the project window in WinCC flexible of the HMI device by selecting "Communication ► Connections" in the "Area pointers" work area. Physically, the user data area is in the PLC.

4.4.3.2 Permitted data types

Permitted data types

The table below lists the data types you may use in the configuration of tags and area pointers.

Table 4-1 Permitted data types

Name	Object	Data type
Tag	V	CHAR, BYTE, INT, WORD, DINT, DWORD, REAL, BOOL, STRINGCHAR
Input	I	CHAR, BYTE, INT, WORD, DINT, DWORD, REAL, BOOL, STRINGCHAR
Output	Q	CHAR, BYTE, INT, WORD, DINT, DWORD, REAL, BOOL, STRINGCHAR
Flag	M	CHAR, BYTE, INT, WORD, DINT, DWORD, REAL, BOOL, STRINGCHAR
Timer	T	Timer
Counter	C	INT

4.4.3.3 Time synchronization via area pointer

Introduction

When the "Date/Time PLC" area pointer is configured, the HMI device reads the date and time cyclically from the PLC. The position of the "Date/Time PLC" user data area is defined in the area pointer.

Procedure

To configure the address of the area pointer, select "Communication ► Connection", then select "Area pointer."

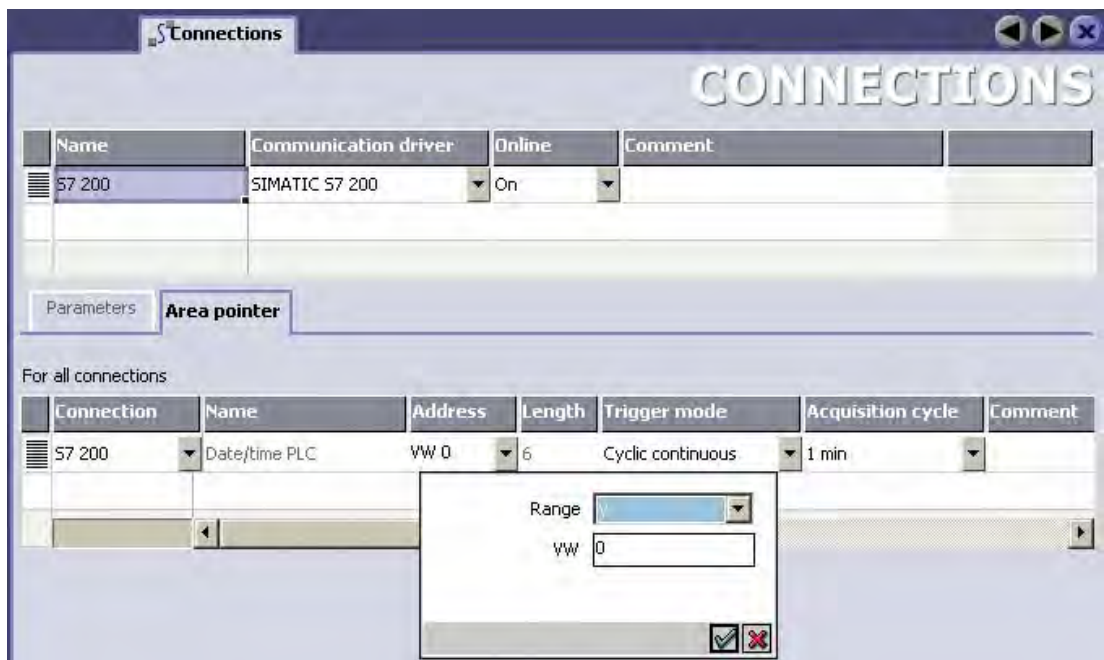

Figure 4-24 Creating an area pointer

- Connection
Name of the connection
- Name
Default name of the area pointer set by WinCC flexible.
- Address
Enter the tag address of the area pointer in the PLC here.
- Length
The default length of the area pointer is set by WinCC flexible.
- Acquisition cycle
Here, define an acquisition cycle to enable the HMI device to read an area pointer cyclically. Make allowances for the fact that a shorter acquisition time may have a negative influence on HMI device performance.

- Comment

This is where you can save a comment which describes the use of the area pointer, for example.

Function

The PLC describes the data area of the "Date/Time PLC" area pointer. All specifications are coded in BCD format.

The HMI device reads the data cyclically based on the configured acquisition cycle and synchronizes itself.

Note

Do not configure an extremely short acquisition cycle for the date/time area pointer because this will have a negative influence on HMI device performance.

Recommendation: Acquisition cycle of 1 minute, if the process allows this.

The HMI device time has a resolution of seconds, regardless of the acquisition cycle.

The date/time data area has the following structure:

DATE_AND_TIME format (in BCD code)

Data word	Most significant byte			Least significant byte		
	7	0	7	0
n+0	Year (80-99/0-29)			Month (1-12)		
n+1	Day (1-31)			Hour (0-23)		
n+2	Minute (0-59)			Second (0-59)		
n+3	Reserved			Reserved	Weekday (1-7, 1=Sunday)	
n+4	Reserved			Reserved		
n+5	Reserved			Reserved		

Note

Note that when you set a Year value, the system sets the years 1980 through 1999 when 80 to 99 is set and the years 2000 through 2029 when 0 to 29 is set.

4.4.3.4 Mechanism of error alarm acknowledgment

Introduction

Alarms indicate the process and plant states on the HMI device.

Alarms are configured in WinCC flexible. Each alarm is assigned an alarm bit in the PLC. Each alarm bit must be a tag or tag element which is configured in WinCC flexible.

Various alarm classes are available. Alarms of the "Error" class must be acknowledged because of their importance.

The following distinctions are made for acknowledgments:

- Acknowledgment on the HMI device
- Acknowledgment by the PLC

Acknowledgment by the PLC

Acknowledgment of error alarms by the PLC requires the "Write acknowledgment tag" function to be configured.

When "Write acknowledgment tag" is set in the PLC, the system automatically acknowledges the corresponding error alarm. This function is identical to the acknowledgment function on the HMI device, for example, triggered with the "ACK" button.

The "Write acknowledgment tag" bit and the alarm bit must be set in the tag.

Reset the acknowledgment bit before the alarm bit is set again in the error alarm area. The figure below shows the pulse diagram.

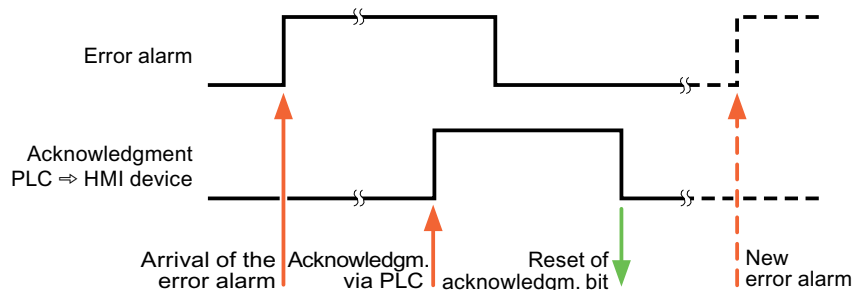

Acknowledgment on the HMI device

The PLC can only detect an error alarm acknowledgment at the HMI device if the "Read acknowledgment tag" bit is configured. The HMI device sets the "Read acknowledgment tag" bit in the PLC after it has acknowledged an alarm.

In order to generate a signal transition each time the acknowledgment bit is set, the HMI device initially resets the corresponding "Read acknowledgment tag" bit when an error alarm bit is set. There is a certain time-based offset between these two operations due to the processing time of the HMI device.

The figure below shows the pulse diagram.

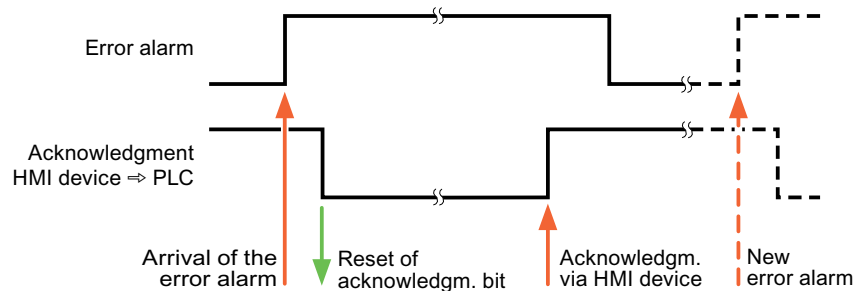

See also

Overview (Page 127)

Acknowledging an Alarm (Page 134)

Acknowledging an Alarm (Page 131)

Operator control components and LEDs

5.1 Front side operator control components and indicators on the OP 73micro



Figure 5-1 Operator control components and LEDs

- ① Soft keys
- ② System keys – control keys

Standard input device at the HMI device is the keyboard. This is basically composed of two key groups:

- Soft keys
F1 to F4

The soft keys can only be assigned within a project and do not have any function in the Loader menu.

- System keys

These include the control keys, for example.

NOTICE

Unintentional actions

Unwanted actions may be triggered if the operator unintentionally actuates several keys at once.

Never press more than two keys simultaneously.

Keyboard damage

Operation of the keys with hard, pointed or sharp objects or hard impact may lead to a considerable reduction of the service life and even to complete failure.

Always use your fingers to operate the keys of your HMI device.

See also

Design of the OP 73micro HMI device (Page 12)

5.2 Front side operator control components and LEDs on the TP 177micro

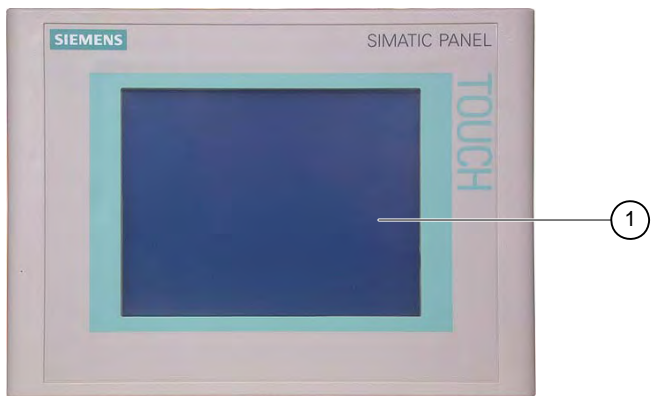

Figure 5-2 Operator control components

- ① Display with touch screen

Standard input unit at the HMI device is the touch screen. All operator control objects required for operator input are displayed on the touch screen once the HMI device has started.

NOTICE
Unintentional actions Never touch more than one point on the display. Never touch more than one touch object at a time, otherwise you may trigger unintentional actions.
Damaging the touch screen The use of with hard, sharp or pointed items or applying excessive pressure when operating the touch screen will substantially reduce its useful life and even lead to total failure. Always operate the HMI device touch screen with your fingers or with a touch pen.

See also

Design of the TP 177micro HMI device (Page 13)

Configuring the operating system

6.1 Configuring the operating system for the OP 73micro

6.1.1 Overview

Loader

The figure below shows the Loader. It appears briefly when the HMI device starts up.

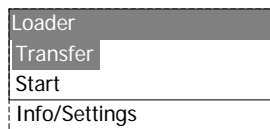





Figure 6-1 Loader

The Loader menu commands have the following functions:





- "Transfer"
Select this menu command to set the HMI device transfer mode.
- "Start"
Select this menu command to start the project which is stored on the HMI device.
- "Info/Settings"
Select this menu command to open the HMI device configuration menu.

The Loader also appears when you close the project.

Navigating in the Loader

Button	Action
 or 	By pressing one of these buttons, you select the next menu command in the direction of the cursor key.
	The corresponding menu opens.
	Returns to the next higher menu layer.

Editing dialog entries

Button	Action
 or 	Selects the previous or next list entry.
	The selected list entry is accepted.
	You can undo your input as long you have not yet confirmed the selected list entry with  .

See also

Switching on power and testing the HMI device (Page 46)

6.1.2 "Info/Settings" menu

6.1.2.1 Overview

Requirements

"Info/Settings" was called in the Loader.

"Info/Settings" menu

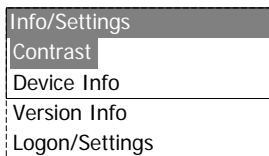

Figure 6-2 "Info/Settings" menu

- "Contrast" Menu command for setting the display contrast
- "Device Info" Menu command with information on the HMI device
- "Version Info" Menu command with information on the version of the HMI device image
- "Logon/Settings" Menu command of the "Logon/Settings" menu

Password protection

You can protect the "Logon/Settings" menu from unauthorized access by assigning a password.

This prevents inadvertent wrong operation and increases security for the plant or machine security because access to the settings is denied. If the user does not enter a password, this user can only access the "Contrast", "Device Info" and "Version Info" menu commands.

When a password is assigned, the following dialog appears when the user attempts to open the "Logon/Settings" menu:



Figure 6-3 Password dialog

You need to enter the password again to access the "Logon/Settings" menu after you closed the previous session.

NOTICE
Password no longer available
If the Loader password is no longer available, you can only call the "Logon/Settings" menu again after you update the operating system.
All data on the HMI device will be overwritten when you update the operating system.

Note

The currently active entry is always indicated in a dialog.

See also

Assigning, editing and deleting passwords (Page 77)

Updating the operating system using WinCC flexible (Page 101)

Updating the operating system in ProSave (Page 102)

6.1.2.2 Setting screen contrast

Requirements

"Info/Settings ► Contrast" was selected from the Loader menu.

Principle

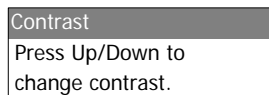

Figure 6-4 "Contrast" dialog

This dialog is used to adjust the contrast and therefore indirectly controls screen brightness.

NOTICE
Screen contrast
The screen contrast can be increased and reduced within a wide range. Note that this may lead to the screen content becoming unrecognizable under unfavorable lighting conditions.



reduces the contrast and



increases the contrast.

6.1.2.3 Displaying information about the HMI device

Requirements

"Info/Settings ► Device Info" was selected from the Loader menu.

Principle

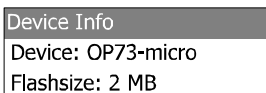

Figure 6-5 "Device Info" dialog

This dialog is used to indicate the name of the HMI device ("Device") and the size of internal Flash memory ("Flashsize"). The Flash memory is used to store the HMI device image and project data. The size of the internal Flash memory does not correspond to the available working memory for a project. This dialog is read only.

6.1.2.4 Viewing information about the version of the HMI device image

Requirements

"Info/Settings ▶ Version Info" was selected from the Loader menu.

Principle

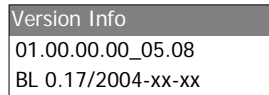

Figure 6-6 "Version Info" dialog – Example

The "Version Info" dialog shows information on the Bootloader and the HMI device image file and therefore the version of the operating system.

This information is required when you contact A&D Technical Support.

6.1.3 "Settings" menu

6.1.3.1 Overview

Requirement

"Info/Settings ▶ Logon/Settings" was selected from the Loader menu. You have entered the password for the "Settings" menu.

"Settings" menu

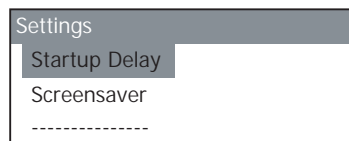

Figure 6-7 "Settings" menu

- "Startup Delay" Menu command for setting the startup delay on the HMI device
- "Screen Saver" Menu command for the screen saver
- "Password" Menu command for the password
- "Transfer Settings" Menu command for transfer settings

Select the "Settings" menu to edit the system settings for your HMI device.

Access to this menu can be protected by a password.

Procedure

Proceed as follows:

1. Close the project.
2. Open the "Logon/Settings" menu.
3. Edit the settings.
4. Close the "Logon/Settings" menu.

6.1.3.2 Setting the delay

Requirements

"Info/Settings ▶ Logon/Settings ▶ Startup Delay" was selected from the Loader menu.

Principle



Figure 6-8 "Startup Delay" dialog

The delay defines the period which the HMI device automatically delays the startup of a stored project.

When the value "0" is set, the project starts immediately. It is then no longer possible to call the Loader after switching on the HMI device. To handle this situation, you must have configured an operator control object you can use to close the project.

Valid range of values: 0 s to 60 s.

6.1.3.3 Setting the screen saver

Requirement

"Info/Settings ▶ Logon/Settings ▶ Screen saver" was selected from the Loader menu.

Principle



Figure 6-9 "Screen saver" dialog

Use this dialog to set the activation delay for the screen saver.

Valid range of values: 5 min to 360 min. The screen saver is disabled when you set 0.

6.1.3.4 Assigning, editing and deleting passwords

Introduction

To restrict access to the "Settings" menu to specific members of staff, define a password in the "Password" dialog.

Requirements

- "Info/Settings ▶ Logon/Settings ▶ Password" was selected from the Loader menu.
- The "Password" dialog opens.

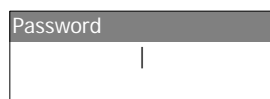

Figure 6-10 "Password" dialog

Procedure – Assigning and editing passwords

Proceed as follows:

1. Enter the password.

Select the first character with  or . Press  to enter additional characters.

Note

Password entry

The last character of the password entered is shown in plain text. The remaining characters are represented by a * character.

2. Press .

You have now completed entry of the password. The "Confirm Password" dialog appears.

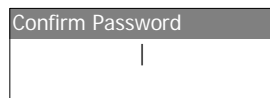

Figure 6-11 "Confirm Password" dialog

You need to enter the password twice to confirm it.

1. Enter the password again.

2. Press .



You have now completed the password confirmation. The password is accepted if both password entries are identical. Otherwise, an error message appears. The "Settings" menu opens. Repeat the password input.

Result

- The "Settings" menu opens.
- The "Settings" menu is password protected.

Procedure – Deleting a password

Proceed as follows:

1. Press  – do not enter any other characters.
The "Confirmation" dialog opens.
2. Press  – do not enter any other characters.
The system confirms the deletion.

Result

- The "Settings" menu opens.
- You have revoked the password protection of the "Settings" menu.

See also

Overview (Page 72)

6.1.3.5 Configure the data channel

Introduction

By disabling a data channel, you can protect the HMI device from unintentional overwriting of project data and of the HMI device image.

Requirements

"Info/Settings ▶ Logon/Settings ▶ Transfer Settings" was selected from the Loader menu.

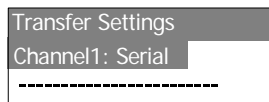

Figure 6-12 "Transfer Settings" menu

Procedure

1. Press .

The "Channel1: Serial" dialog opens.

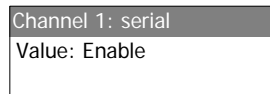





Figure 6-13 "Channel1: Serial" dialog

This dialog is used to configure the RS495 port for serial data transfer.

1. Select the relevant setting using the  and  cursor keys.
 - "Disable"
 - Serial data transfer is disabled.
 - "Enable"
 - Serial data transfer is enabled.
2. Accept the required value with .

Note

Transfer settings

The data channel must be enabled to allow the download of project data from the configuration computer to the HMI device.

6.2 Configuring the operating system for the TP 177micro

6.2.1 Overview

Loader

The figure below shows the Loader. It appears briefly when the HMI device starts up.

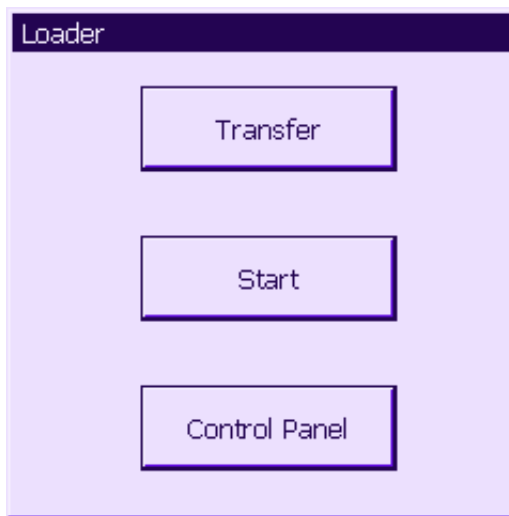

Figure 6-14 HMI device Loader

The Loader buttons have the following functions:

- Use the "Transfer" button to set "Transfer" mode on the HMI device.
- Press the "Start" button to open the project stored on the HMI device.
- Press "Control Panel" to open the HMI device Control Panel.

The Control Panel is used to configure various settings such as the transfer settings.

The Loader also appears when you close the project.

Password protecting the Control Panel

You can protect the Control Panel from unauthorized access. You can read the settings in the Control Panel without entering a password but you cannot edit all settings.

This prevents inadvertent wrong operation and increases security for the plant or machine security because access to the settings is denied.

NOTICE

If the Control Panel password is no longer available, you cannot change settings in the Control Panel unless you update the operating system.

All data on the HMI device will be overwritten when you update the operating system.

See also

Switching on power and testing the HMI device (Page 55)

6.2.2 Control Panel

6.2.2.1 Overview

Control Panel of the HMI device

The HMI device Control Panel can be used to modify the following HMI device settings:

- Screen settings
- Transfer settings

Opening the Control Panel

Open the Control Panel using the HMI device Loader.

The following options are available to open the Loader:

- The Loader appears briefly after starting the HMI device.
- During runtime:

If configured, touch the relevant operator control object to stop the project. The Loader is displayed. Further information on this may be available in your plant documentation.

Touch the "Control Panel" button in the Loader to open the HMI device Control Panel.

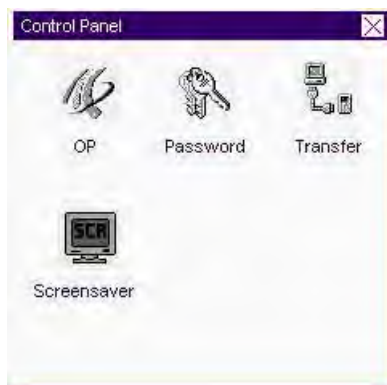

Figure 6-15 HMI device Control Panel

"OP"	Change screen settings, display information on HMI device, calibrate touch screen
"Password"	Set password protection for the Control Panel
"Screen Saver"	Configuring the screen saver
"Transfer"	Configure the data channel

General Procedure

Proceed as follows to change settings in the Control Panel:

1. You must exit the project before changing settings in the Control Panel. Use the relevant operator control object provided in the project.
2. Open the Control Panel as described above.
3. To change settings, touch the respective input field or check box and use the displayed screen keyboard if necessary. Enter the required password if the Control Panel is protected against unauthorized access. Change the HMI device settings in the Control Panel.

Close the Control Panel: Touch the  button.

4. Start the project using the Loader.

6.2.2.2 Changing screen settings

Requirements

The "OP"  icon on the Control Panel has been touched.

Procedure

Proceed as follows:

1. From the "OP Properties" dialog, select the "Display" tab.

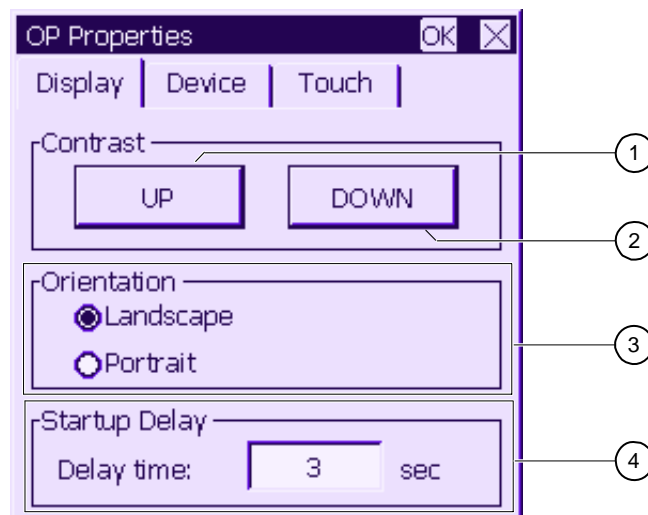

Figure 6-16 "OP Properties" dialog, "Display" tab

- ① Button for increasing the contrast
- ② Button for reducing contrast
- ③ Screen orientation settings
- ④ Input field for the delay time at the startup of the HMI device

2. The "Contrast" group contains the "UP" and "DOWN" buttons. To adjust the screen contrast:
 - Touch the "UP" button to increase screen contrast.
 - Touch the "DOWN" button to reduce screen contrast.
3. The "Orientation" group contains the "Landscape" and "Portrait" buttons. To adjust the screen orientation:
 - Set the "Landscape" check box to set the HMI device screen for horizontal orientation.
 - Set the "Portrait" check box to set the HMI device screen for vertical orientation.
4. The "Startup Delay" group contains the "Delay time" input field you can use to adjust the delay at the startup of your HMI device. The delay represents the interval in seconds which expires between the appearance of the Loader and start of the project.

When the value "0" is set, the project starts immediately. It is then no longer possible to call the Loader after switching on the HMI device. To handle this situation, you need to configure an operator control object with "Close project" function.

The valid value range is 0 s to 60 s.
5. Close the dialog and save your entries with **OK**. Touch **X** to discard the values.

Result

You have completed your HMI device screen settings.

Screen orientation

The orientation of the screen is determined by the configuration engineer when he creates the project. When the project is transferred to the HMI device, the appropriate screen orientation is set automatically.

NOTICE

If there is a project on the HMI device, do not change the screen orientation.
--

You can change the screen orientation in the Control Panel, for example, if you have to operate the Loader on a vertically installed HMI device without the project.

6.2.2.3 Displaying information about the HMI device

Requirements

You have touched the "OP" icon on the Control Panel.

Procedure

Proceed as follows:

1. Open the "OP Properties" dialog and select the "Device" tab.

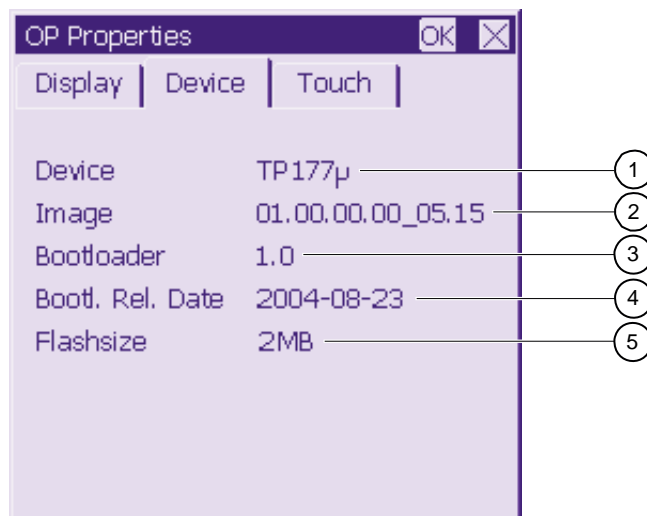

Figure 6-17 "OP Properties" dialog, "Device" tab – example

- ① HMI device name
 - ② Version of the HMI device image
 - ③ Version of the boot loader
 - ④ Boot loader release date
 - ⑤ The Flash memory is used to store the HMI device image and project data.
2. The "Device" tab is used to display specific HMI device information. There are no input options.
This information is required when you contact A&D Technical Support.
 3. Use **X** or **OK** to close the dialog when the information is no longer required.

Note

The size of the internal Flash memory does not correspond to the available working memory for a project.

6.2.2.4 Calibrating the touch screen

Introduction

Depending on the mounting position and viewing angle, it is possible that parallax may occur when operating the HMI device. In order to prevent any operating errors as a result, calibrate the screen again in the startup phase or during runtime.

Requirements

The "OP"  icon on the Control Panel has been touched.

Procedure

Proceed as follows:

1. Open the "OP Properties" dialog, then select the "Touch" tab.

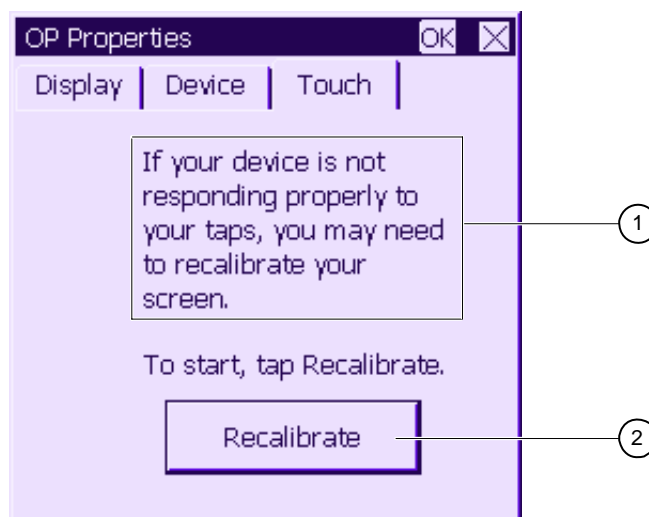

Figure 6-18 "OP Properties" dialog, "Touch" tab

- ① If the HMI device does not react precisely to a touch, the touch screen may require calibration.
- ② Button for calibrating the touch screen

2. Touch the "Recalibrate" button.
3. Follow the instructions on the HMI device screen.
4. Close the dialog with **OK**.

Result

The HMI device touch screen is now recalibrated.

6.2.2.5 Changing the password setting for the Control Panel

Requirements



The "Password" icon in the Control Panel has been touched.

The "Password Properties" dialog is shown.

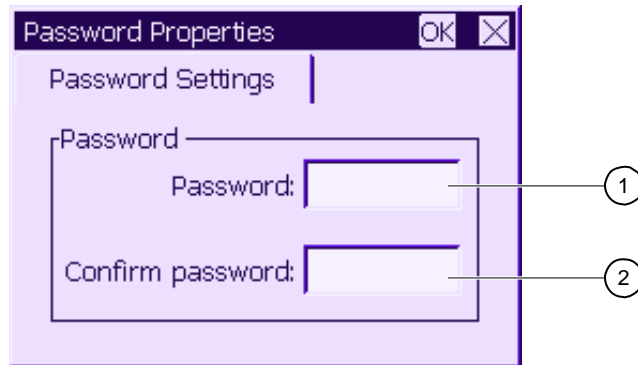

Figure 6-19 "Password Properties" dialog

- ① Password input field
- ② Input field for entering the password a second time

Procedure – Entering a password

Proceed as follows:

1. Enter a password in the "Password" input field.
Touch the input field. The alphanumerical screen keyboard is displayed.
2. Repeat the password entry in the "Confirm Password" input field.
3. Close the dialog with **OK**.

NOTICE

The password may not contain space characters or the special characters * ? . % / \ ' " .

Result

The Control Panel is protected from unauthorized access. Without entering a password, you can read some settings but you cannot change them.

NOTICE

If the Control Panel password is no longer available, you cannot change settings in the Control Panel unless you update the operating system.

All data on the HMI device will be overwritten when you update the operating system.

Procedure – Deleting a password

Proceed as follows:

1. Delete the entries for "Password" and "Confirm Password".
2. Close the dialog with **OK**.

Result

Password protection for the Control Panel menu is revoked.

See also

Overview (Page 80)

6.2.2.6 Setting the Screen Saver

Introduction

You can set a period of time for automatic activation of the screen saver on the HMI device. The screen saver is automatically activated if the HMI device is not operated within the specified period of time.

The screen saver stops in the following situations:

- When you touch the touch screen.
- A message is displayed.

Requirements

The "Screen Saver" dialog has been opened with the "Screen Saver"  icon.

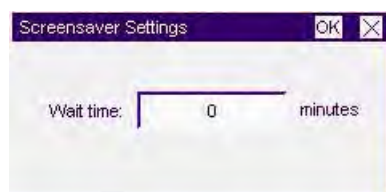

Figure 6-20 "Screen saver" dialog

Procedure

Proceed as follows:

1. Enter the number of minutes before the screen saver is to be activated.
Touch the input field. You can enter a value between 5 and 360 minutes. Entering "0" deactivates the screen saver.
2. Close the dialog and save your entries with **OK**. Touch **X** to discard the entries.

NOTICE
Activating the Screen Saver
You should always activate the screen saver. Otherwise, the screen contents may leave a burn-in effect in the background if they appear too long.
This effect is reversible, however.

Result

The screen saver for the HMI device has now been set.

6.2.2.7 Configure the data channel

Introduction

By disabling a data channel, you can protect the HMI device from unintentional overwriting of project data and of the HMI device image.

Requirements

You have touched the "Transfer" icon on the Control Panel.
The "Transfer Settings" dialog is displayed.

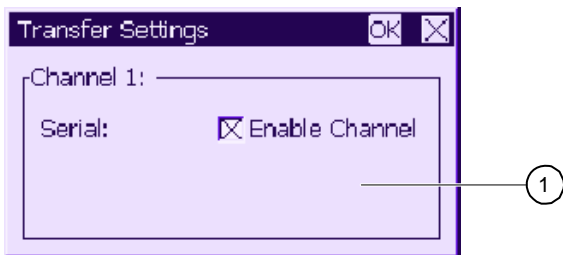

Figure 6-21 "Transfer Settings" dialog

This dialog is used to configure the RS495 port for serial data transfer.

- ① Group for data channel 1 (Channel 1)

Procedure

Enable the "Channel 1" data channel by setting the "Enable Channel" check box:

- Set the "Enable Channel" check box to enable serial transfer.
- Reset the "Enable Channel" check box to disable serial transfer.

Note

Transfer settings

The data channel must be enabled to allow the download of project data from the configuration computer to the HMI device.

Preparing and backing up a project

7.1 Overview

Configuration and process management phases

HMI devices can be used to operate and monitor tasks in process and production automation. The plant screens on the HMI devices are used to provide a clearer overview of active processes. The HMI device project, which includes the plant screens, is created during the configuration phase.

Once the project is transferred to the HMI device and the HMI device is connected to a PLC in the automation system, processes can be operated and monitored in the process management phase.

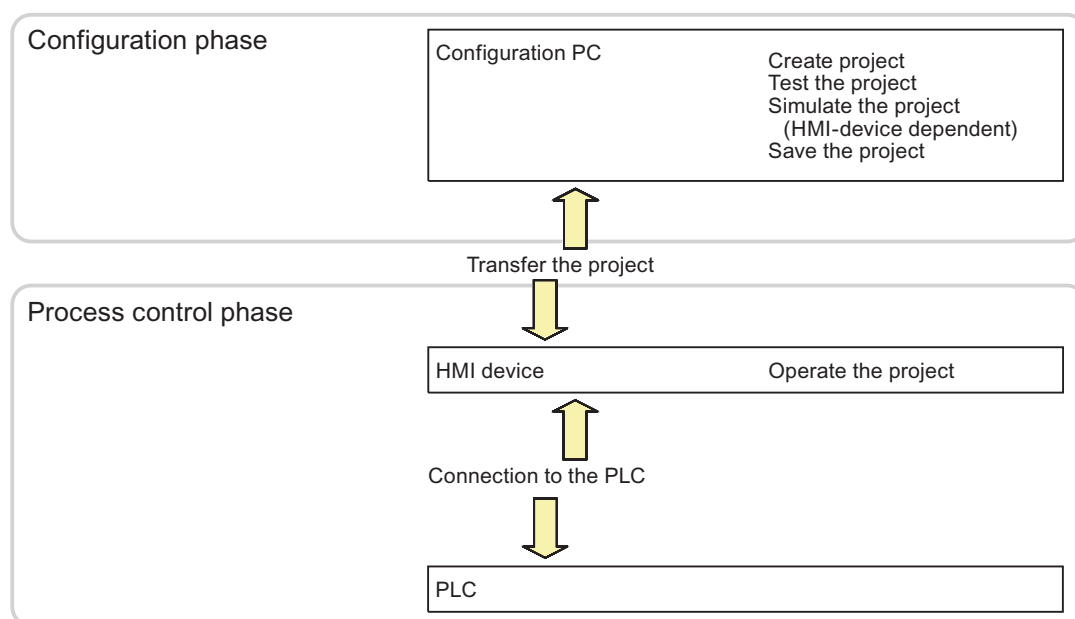

Figure 7-1 Configuration and process management phases

Transferring the project to the HMI device

The following can be performed to transfer a project to an HMI device:

- Transfer the project from the configuration computer
- Restore the project from a PC using ProSave

In this case, an archived project is transferred from a PC to the HMI device. The engineering software need not be installed on this PC.

These procedures can be available for commissioning and recommissioning a project.

Commissioning and recommissioning

- When the HMI device is commissioned there is no project at first.
The HMI device is also in this state after the operating system has been updated.
- When recommissioning, any project on the HMI device is replaced.

7.1.1 Setting the operating mode

Operating modes

Operating modes of the HMI device:

- Offline
- Online
- Transfer

"Offline mode" and "Online mode" can be set on the configuration computer and on the HMI device. To set these modes on the HMI device, use a corresponding operator control object of the project.

Changing the operating mode

The configuration engineer must have configured an appropriate operator control object to allow a change of the operating mode on the HMI device during ongoing operation.

Further information on this may be available in your plant documentation.

"Offline" mode

In this mode, there is no communication between the HMI device and PLC. Although the HMI device can be operated, it cannot exchange data with the PLC.

"Online" mode

In this mode, the HMI device and PLC communicate. You can operate the plant on the HMI device according to your system configuration.

"Transfer" mode

In this mode, you can transfer a project from the configuration computer to the HMI device or backup and restore HMI device data, for example.

The following options are available for setting "Transfer" mode on the HMI device:

- When the HMI device starts up
 - Start "Transfer" mode manually in the HMI device Loader.
- During ongoing operation
 - Start transfer mode manually within the project using an operator control object.

7.1.2 Reusing existing projects

You can reuse existing projects on the HMI devices.

The following cases are possible:

1. Reusing projects on OP 73micro

Existing OP3 projects can be reused on OP 73micro.

Migrate the OP3 project to WinCC flexible (compact, standard, advanced) into an OP 73 project, then replace your HMI device with the OP 73micro.

2. Reusing existing projects on TP 177micro

- TP 170A project available in ProTool

Migrate the TP 170A project to WinCC flexible (compact, standard, advanced) and then replace your HMI devices with a TP 177micro.

- TP 170A project available in WinCC

In WinCC flexible (Compact, Standard, Advanced), replace your HMI device with a TP 177micro.

- TP 170micro project available in WinCC flexible

In WinCC flexible (Compact, Standard, Advanced), replace your HMI device with a TP 177micro.

Note

Projects for TP 070 can not be reused.

For more information, please see the online help for WinCC flexible or the "WinCC flexible Migration" user manual.

7.1.3 Data Transfer Options

Overview

The following table shows the options for transferring data between the configuration computer and OP 73micro or TP 177micro.

Type	Type	OP 73micro	TP 177micro
Backup	Serial (with reset to factory setting)	No	No
	Serial	Yes	Yes
Restore	Serial (with reset to factory setting)	Yes ¹⁾ / No ²⁾	Yes ¹⁾ / No ²⁾
	Serial	No ¹⁾ / Yes ²⁾	No ¹⁾ / Yes ²⁾
Updating the operating system	Serial (with reset to factory setting)	Yes	Yes
	Serial	No	No
Transfer of a project	Serial (with reset to factory setting)	No	No
	Serial	Yes	Yes

- 1) Applies to complete restore
- 2) Applies to restoring the password list

Serial transmission

You can use one of the following adapters for the serial transmission to the configuration PC:

- RS 232/PPI cable MM Multimaster
- USB/PPI cable MM Multimaster (as of manufacturer version 05 of the cable)

7.2 Transfer

7.2.1 Overview

Transfer

During transfer, the project is downloaded from the configuration computer to the HMI device.

"Transfer" mode can be started on the HMI device.

Transferred data is written directly to the flash memory on the HMI device. The data channel must be configured before you start the transfer.

7.2.2 Starting transfer

Introduction

You can set "Transfer" mode manually on the HMI device using a configured operator control object and during ongoing operation.

Requirements

- The *.hmi project is opened in WinCC flexible.
- The HMI device is connected to a configuration computer.
- The data channel is configured on the HMI device.
- The HMI device Loader is opened.

Procedure

Proceed as follows to initiate the transfer:

1. Switch to "Transfer" mode on the HMI device.
2. Proceed as follows on the configuration computer:
 - Select the "Project ▶Transfer ▶Transfer Settings" menu command in WinCC flexible.
 - Select the HMI device and define the parameters for the connection.
 - Start the download with "Transfer".

The configuration computer verifies its connection to the HMI device. If the connection is not available or is faulty, the configuration computer outputs an alarm. If no communication error is detected, the project is transferred to the HMI device.

Result

When the transfer is completed successfully, the data can be found on the HMI device. The transferred project is then started automatically.

See also

Configure the data channel (Page 88)

Configure the data channel (Page 79)

Setting the operating mode (Page 90)

Data Transfer Options (Page 92)

7.2.3 Testing a project

Introduction

There are two options on the HMI device testing a project:

- Offline testing of the project

Offline testing means that communication between the HMI device and PLC is down while the test is being carried out.

- Online testing of the project

Online testing means that the HMI device and PLC communicate with each other during testing.

Perform both tests, starting with the "Offline test", followed by the "Online test".

Note

You should always test the project on the HMI device on which the project will be used.

Check the following:

1. Check the correct layout of the screens.
2. Check the screen structure.
3. Check the input objects.
4. Enter the tag values.

The test increases the certainty that the project will run error-free on the HMI device.

Requirements for the offline test

- The project has been transferred to the HMI device.
- The HMI device is in "Offline" mode.

Procedure

In "Offline" mode, you can test the various project functions on the HMI device without them being affected by the PLC. PLC tags, therefore, are not updated.

Test the operator control objects and visualization of the project as far as possible without connecting to the PLC.

Requirements of the online test

- The project has been transferred to the HMI device.
- The HMI device is in "Online" mode.

Procedure

In "Offline" mode, you can test the various project functions on the HMI device without them being affected by the PLC. PLC tags are updated in this case.

Test the operator control objects and views of the project.

See also

Setting the operating mode (Page 90)

7.3 Backup and restore

7.3.1 Overview of backup and restoring

Introduction

Data located on the HMI device can be backed up using a PC external to the HMI device and can be restored from it.

The following data in the internal Flash memory can be backed up and restored:

- Project and HMI device image
- Password list

Backup and restoring can be performed in the following ways:

- WinCC flexible
- ProSave

General notes

NOTICE

Power failure

If an operation for restoring data is interrupted due to power failure on the HMI device, the operating system of the HMI device may be deleted! The operating system then has to be updated.

Compatibility conflict

If a message is output on the HMI device warning of a compatibility conflict during the restore operation, the operating system must be updated.

7.3.2 Resetting to Factory Settings for Backup and Restore

Reset to factory setting

In ProSave or WinCC flexible, you can perform a restore with or without resetting to factory settings.

- Restoring the password list without reset to factory setting

First, set "Transfer" mode at the HMI device. Then start the restore in ProSave or WinCC flexible.

- Restoring all project data and the HMI device image with reset to factory setting

First, start the restore in ProSave or WinCC flexible and then switch the power on the HMI device off and on again.

Note

Restoring with with reset to factory setting is also possible when the HMI device operating system is corrupt and you can therefore can no longer run the Loader of the HMI device.

Use the "Reset to factor state" check box in ProSave to determine the restoring procedure.

7.3.3 Backup and Restore via WinCC flexible

Introduction

Backup and restore operations transfer the relevant data between flash memory on the HMI device and a configuration computer.

Requirement

- The HMI device is connected to a configuration computer.
- No project is open in WinCC flexible.
- Only for restoring the password list or when backing up the data:
The data channel is configured on the HMI device.

Procedure - backup

Proceed as follows:

1. Select the menu command "Project ► Transfer ► Communication Settings" in WinCC flexible on the configuration computer.
The "Communication Settings" dialog opens.
2. Select the HMI device type.
3. Select the type of connection between the HMI device and the configuration computer, then set the communication parameters.
4. Close the dialog with "OK".

5. In WinCC flexible, select the menu command "Project ► Transfer ► Backup".
The "Backup Settings" dialog opens.
6. Select the data to be backed up.
7. Select a destination folder and a file name for the *.psb backup file.
8. Set "Transfer" mode on the HMI device.
9. Start the backup operation in WinCC flexible with "OK" on the configuration computer.
Follow the instructions in WinCC flexible.
A status view opens to indicate the progress of the operation.

Result

The system outputs a message when the backup is completed.
The relevant data is now backed up on the configuration computer.

Procedure - restore

Proceed as follows:

1. When restoring with reset to factory setting only:
Switch off power to the HMI device.
2. Select the menu command "Project ► Transfer ► Communication Settings" in WinCC flexible on the configuration computer.
The "Communication Settings" dialog opens.
3. Select the HMI device type.
4. Set the connection parameters.
5. Close the dialog with "OK".
6. In WinCC flexible, select the menu command "Project ► Transfer ► Restore".
The "Restore Settings" dialog dialog opens.
7. Select the *.psb backup file to be restored from the "Open" dialog.
The view shows from which HMI device the backup file originates and the type of data it contains.
8. To restore the password list:
Set "Transfer" mode on the HMI device.
9. Start the restore operation in WinCC flexible with "OK" on the configuration computer.
Follow the instructions in WinCC flexible.
A status view opens to indicate the progress of the operation.

Result

The transfer is completed when the backup data is restored from the configuration computer to the HMI device.

See also

- Configure the data channel (Page 88)
- Configure the data channel (Page 79)
- Setting the operating mode (Page 90)
- Overview of backup and restoring (Page 95)
- Data Transfer Options (Page 92)

7.3.4 Backup and Restore via ProSave

Introduction

Backup and restore operations transfer the relevant data between flash memory on the HMI device and a PC.

Requirement

- The HMI device is connected to a PC on which ProSave is installed.
- Only for restoring the password list or when backing up the data:
The data channel is configured on the HMI device.

Procedure - backup

Proceed as follows:

1. From the Windows Start menu, run ProSave on the PC.
2. Select the HMI device type from the "General" tab.
3. Set the connection parameters in the "General" tab.
4. Use the "Backup" tab to select the relevant data.
5. Select a destination folder and a file name for the *.psb backup file.
6. Set "Transfer" mode on the HMI device.
7. Start the backup operation in ProSave with "Start Backup".

Follow the instructions in ProSave.

A status view opens to indicate the progress of the operation.

Result

The system outputs a message when the backup is completed.

The relevant data is now backed up on the PC.

Procedure - restore

Proceed as follows:

1. When restoring with reset to factory setting only:
Switch off power to the HMI device.
2. From the Windows Start menu, run ProSave on the PC.
3. Select the HMI device type from the "General" tab.
4. Set the connection parameters in the "General" tab.
5. Select the *.psb backup file to be restored from the "Restore" tab.

The tool outputs a message showing the HMI device for which the backup copy was created and the type of backup data contained in this file.

6. To restore the password list:
Set "Transfer" mode on the HMI device.
7. Start the restore operation in ProSave with "Start Restore".
Follow the instructions in ProSave.
A status view opens to indicate the progress of the operation.

Result

The transfer is completed when the backup data is restored from the PC to the HMI device.

See also

- Configure the data channel (Page 88)
- Configure the data channel (Page 79)
- Setting the operating mode (Page 90)
- Overview of backup and restoring (Page 95)
- Data Transfer Options (Page 92)

7.4 Updating the operating system

7.4.1 Overview

Overview

A compatibility conflict may occur when transferring a project to the HMI device. This is caused by different versions of the engineering software and the HMI device image. The configuration computer cancels the transfer and triggers an alarm to indicate a compatibility conflict. You must update the operating system of the HMI device.

NOTICE
Data loss An operating system update deletes all data such as projects and passwords from the HMI device.

7.4.2 Updating the operating system using WinCC flexible

Requirements

- The HMI device is connected to a configuration computer.
- No project is open in WinCC flexible.

Procedure

Proceed as follows:

1. Switch off power to the HMI device.
2. Select the menu command "Project ▶ Transfer ▶ Communication Settings" in WinCC flexible on the configuration computer.
This opens the "Communication Settings" dialog.
3. Select the HMI device type.
4. Set the connection parameters.
5. Close the dialog with "OK".
6. In WinCC flexible, select the menu command "Project ▶ Transfer ▶ Update operating system".
7. In "Image path," select the folder which contains the HMI device image file, *.img.
The HMI device image files are available under "WinCC flexible Images" in the WinCC flexible installation folder and on the corresponding WinCC flexible installation CD.
8. Select "Open".
In the output area, you are provided information on the version of the HMI device image file after it is opened.
9. In WinCC flexible, select "Update OS" to run the operating system update.
Follow the instructions in WinCC flexible.
A status view opens to indicate progress.

Result

The system outputs and alarm when the operating system update is completed.
This operation has deleted the project data from the HMI device.

See also

Overview (Page 100)
Data Transfer Options (Page 92)

7.4.3 Updating the operating system in ProSave

Requirements

- The HMI device is connected to a PC on which ProSave is installed.

Procedure

Proceed as follows:

1. Switch off power to the HMI device.
2. From the Windows Start menu, run ProSave on the PC.
3. Select the HMI device type from the "General" tab.
4. Set the connection parameters.
5. Select the "OS Update" tab.
6. In "Image path," select the folder which contains the HMI device image file, *.img.
The HMI device image file is available on the corresponding WinCC flexible installation CD.
7. Select "Open".
In the output area, you are provided information on the version of the HMI device image file after it is opened.
8. On the PC, select "Update OS" to run the operating system update.
Follow the instructions in ProSave.
A status view opens to indicate progress.

Result

The system outputs and alarm when the operating system update is completed.
This operation has deleted the project data from the HMI device.

See also

Overview (Page 100)

Data Transfer Options (Page 92)

Operating a project

8.1 Operating a project on OP 73micro

8.1.1 Overview

Soft keys with global function assignment

A soft key with global function assignment always triggers the same action on the HMI device or in the PLC, regardless of the current screen. An example of such an action is the activation of a screen.

The soft key of a screen can be assigned either a global or a local function. The local function takes priority over the global setting.

Soft keys with local function assignment

A soft key with local function assignment is screen-specific and is therefore only effective within the active screen.

The function assigned to a soft key can vary from screen to screen.

Operation with key combinations

Unwanted actions may be triggered if the operator unintentionally actuates a key combination.

CAUTION

Unintentional actions

















In "Online" mode, simultaneous operation of more than two keys may cause unintentional actions in the plant.

Never press more than two keys simultaneously.

System keys



The system keys (control keys) are used for operator input on the HMI device.

Table 8-1 Overview of control keys

Function	Action
Moving the cursor  , 	Activates the next field in horizontal direction
 , 	Activates the next field in vertical direction
Activate field  + 	Activates the next field in the tab order defined in your project
	Enables an overlay function of a further system key
Viewing infotext  + 	Opens a window containing infotext on the selected object You can press  to toggle between infotext for a screen and an object, for example, for an IO field.
Cancel action. 	<ul style="list-style-type: none"> Undo You can undo your input as long you have not yet confirmed it with . Close the alarm window - if configured. Cancel the output of infotext to return to the previous view.
Acknowledge alarm 	Acknowledges the current indicated or selected alarm or all alarms of an acknowledgment group, depending on your configuration.
	<ul style="list-style-type: none"> Call editing mode – initiates input with  and  Exit editor mode and confirm input

Navigating in lists

Table 8-2 Keys for navigation in lists

Button	Action on pressing
 or 	Selects the previous or next list entry

8.1.2 Setting the project language

Introduction

The HMI device supports multilingual projects. You need to configure a corresponding operator control object which lets you change the language setting on the HMI device during runtime.

The project always starts with the language set in the previous session.

Requirements

- The relevant project language must be available on the HMI device.
- The language changeover function must be logically linked to a configured operator control object such as a button.

Selecting a language

You can change project languages at any time. Language-specific objects are immediately output to the screen in the relevant language when you switch languages.

The following options are available for switching the language:

1. A configured operator control object switches from one project language to the next in a list.
2. A configured operator control directly sets the desired project language.

Further information on this may be available in your plant documentation.

8.1.3 Entries and help within a project

8.1.3.1 Overview

Procedure

Values are entered in the project input fields. The values are transferred from the input fields to the PLC.

Proceed as follows:

1. Select the required input field on the screen.

Based on your configuration, you can enter the following type of values in the input field:



- Numerical
- Alphanumerical
- Symbolic
- Date/time

2. Set the value.

3. Confirm your entries with  or cancel your entries with .

Numerical values

Enter the characters of numerical values using the system keyboard. Press  to edit any character of the value with the help of the cursor keys.

You can delete a value from the field by pressing  + .

Formats for the visualization of numerical values

You can enter values in numerical input fields based on the following formats:

- Decimal
- Hexadecimal
- Binary

The entry can be aligned left or right, depending on the configuration.

Limit value test of numerical values



Tags can be assigned limit values. If an alarm window has been configured, a system alarm is automatically output to indicate any violation of set limits of the input value, for example, 80 exceeds the set limit value of 78. The value entered is rejected. The original value is displayed again.

Decimal places for numerical values

If a numerical input field is configured for a specific number of decimal points, decimal places in excess of the limit are ignored. Empty decimal places are filled with "0" after the number is confirmed.

Alphanumerical values

Enter the alphanumerical values, numbers and letters character by character using the system keyboard. Press  to edit any character of the value with the help of the cursor keys.

You can delete a value from the field by pressing  + .

The extended character set is available for fields with "String" format.

Symbolic values

Symbolic values are by selecting configured entries and not using the keyboard. These entries are stored in symbolic IO fields.

Date and time

Date and time are entered in alphanumerical format.



8.1.3.2 Entering and Editing Numerical and Alphanumerical Values

Requirement

An IO field has been enabled with  +  or using the cursor keys.









Navigating in fields

Table 8-3 Overview of control keys for navigating in fields

Key	Action
 or 	The previous or following character is marked.

Control keys for character input

Table 8-4 Overview of the control keys for character input

Key	Action
 + 	Changes the sign of a numerical value. Press  +  to toggle between the two characters.
	This toggles between upper and lower case letters.
 or 	All characters available in the extended character set are called in succession.
	Validates the input
	Deletes the entry Restores the original value





Options of entering numerical and alphanumerical characters:

- Enters value and thereby fully replace the existing value
- Edit a character in an existing value

Procedure – entering values

To enter a new value instead of editing a character, you can delete the entire contents of the input field.







Proceed as follows:

1.  press to mark the entire field contents
2. Enter the value with  or .
3. Press .

This confirms your entries. To cancel the entry, press .



Procedure – editing specific characters of a value

Proceed as follows:

1. Press .
2. Select the relevant character with  or .
3. Replace the character with  or .
4. Press .

This confirms your entries. To cancel the entry, press .

Call sequence of the characters

When you initially enter a value in an alphanumerical input field, the letter "A" is called by pressing  or . The same applies when you add characters.

The following applies for further entries:



- Press  to enter letters.

Upper and lower case letters are indicated first, followed by the special characters and numbers.



To toggle between an upper and a lower case letter, press .

- Press  to enter numbers.

The list opens with various special characters and continues with the numbers.

Press  or  to view the next value if you already entered a value.

Procedure – deleting a character



1. Press .
2. Position the cursor on the character to be deleted.
3. Press  + .

The selected character will be deleted. The remaining characters to the right of the cursor shift by one position to the left.

If the characters are right aligned:

The selected character will be deleted. The remaining characters to the left of the cursor shift one position to the right.

Procedure – inserting characters

1. Press .
2. Move the cursor to the required position.
3. Press  +  to insert a space character.













The characters already entered move one position to the right from the cursor position.

If the characters are right aligned:

The characters already entered move one position to the left from the cursor position.











Example for numerical input

Activate the the input box. The following table shows the keys you need to press to enter "-12.34":

Key	Instruction	Display
	Press 1 x to begin input	+00.00
	Press 5 x to move the marking five positions to the left	+ 00.00
	Keep pressing until "-" appears	- 00.00
	Press 1 x to move the marking one position to the right	- 0 0.00
	Keep pressing until "1" appears	- 1 0.00
	Press 1 x to move the marking one position to the right	-1 0 .00
	Keep pressing until "2" appears	-1 2 .00
	Press 2 x to move the marking one position to the right	-12. 0 0
	Keep pressing until "3" appears	-12. 3 0
	Press 1 x to move the marking one position to the right	-12.3 0
	Keep pressing until "4" appears	-12.3 4
	Press 1 x to end input	-12.34

Example for alphanumerical input

Activate the the input box. The following table shows the keys you need to press to enter "OP 73":





Key	Instruction	Display
	Press 1 x to begin input	A <input type="text"/>
	Keep pressing until "O" appears	O <input type="text"/>
	Press 1 x to move the marking one position to the right	OA <input type="text"/>
	Keep pressing until "P" appears	OP <input type="text"/>
 + 	Press both keys 1 x simultaneously to create a space character	OP <input type="text"/>
	Press 1 x to move the marking one position to the right	OP A <input type="text"/>
	Keep pressing until "7" appears	OP 7 <input type="text"/>
	Press 1 x to move the marking one position to the right	OP 7 A <input type="text"/>
	Keep pressing until "3" appears	OP 7 3 <input type="text"/>
	Press 1 x to end input	OP 7 3 <input type="text"/>

8.1.3.3 Entering and editing symbolic values

Requirements

A symbolic IO field has been with  +  or using the cursor keys.

Control keys for character input



Button	Action
 , 	Scrolls in a single-line list field until the required entry is found
	Validates the selected entry Disables editing mode
	Restores the original entry Disables editing mode

Procedure

Proceed as follows:



1. Enable the selection list with .

This enables the selection list which contains the configured symbolic entries.

2. Select an entry with  or .
3. Save or cancel the entry.

8.1.3.4 Entering and modifying date and time

Requirements

A date/time input field has been enabled with  +  or using the cursor keys.

Entering the date and time

Use numerical and alphanumerical values to set the date and time.

Note

When entering the date and time, please note that the format is determined by the configured project language.

See also

Entering and Editing Numerical and Alphanumerical Values (Page 107)

Setting the project language (Page 105)

8.1.3.5 Viewing infotext

Introduction

The configuration engineer uses infotext to provide additional information and operating instructions with respect to screens and operable screen objects.

An infotext may contain information on the value to be set in an IO field, for example.

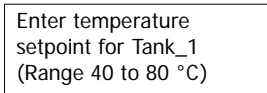

Figure 8-1 Infotext for an IO field, example

A help indicator can also be configured.







Figure 8-2 Help indicator

If there is an infotext available for the active screen, the help indicator is always displayed. If infotext is available for a screen object, the help indicator is displayed as soon as the cursor is placed over the screen object. If there is no infotext for the selected operator control object or the active screen, the help indicator is hidden.

Procedure

To view an infotext on the HMI device, press  + . There are two viewing options:

- If the cursor is positioned in a field for which infotext has been configured, press  +  to view the infotext.
- If  +  is pressed and no infotext is available for the field, the infotext configured for the active screen is shown instead.

If an infotext is not available for this active screen, the system opens the following dialog:

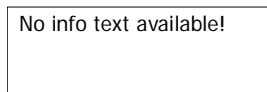

In this dialog, scroll through the list with  or . Press  to close the dialog.

If you have configured screen and IO field infotexts, you can toggle these in your view by pressing .

8.1.4 Project security

Overview

Operation of a project can be protected by the configuration engineer by implementing a security system.









If operator control objects protected by a password are operated, the HMI device requests the entry of a password. A logon dialog opens for you to enter the password.

User:	Admin
Password:	<input type="text"/>
<input type="button" value="OK"/>	<input type="button" value="Cancel"/>

Figure 8-3 Logon dialog

Enter the password in the "Password" input field of the logon dialog.

Proceed as follows:

1. Press .
2. Press and hold the  or  key until the required character appears.
3. To obtain additional characters, press  and select the character with  or .
4. When the password is completed, enable the "OK" button with  +  and press .
. Select "Cancel" to cancel the operation.

You can use the protected control objects after you completed the logon.

The Logon dialog can be set up by the configuration engineer via an individual operator control object.

In the same way, the configuration engineer can set up an operator control object to log off. After logging off, objects assigned password protection can no longer be operated; to do so, log on again.

Further information on this may be available in your plant documentation.

Logoff time

A user logoff timeout can be set in the system. If the time between any two user actions, e.g, entering a value or changing screens, exceeds this logoff time, the user is automatically logged off. The user must then log on again to continue to operate objects assigned password protection.

Password

The password and logoff timeout values are coded in a list and saved to non-volatile memory on the HMI device.

Note

Depending on the transfer settings, changes to the password list are overwritten when the project is transferred again.

Backup and restore

You can backup the password and restore it using ProSave or WinCC flexible.

NOTICE
On restoring, the currently valid password is overwritten. The restored password is immediately valid.

8.1.5 Close the project.

Procedure

Proceed as follows:

1. Use the corresponding operator control object to close the project.
Wait for the Loader to open after you closed the project.
2. Switch off power to the HMI device.

8.2 Operating a project on TP 177micro

8.2.1 Overview

Operating touch objects

Touch objects represent touch-sensitive operator control objects on the HMI device screen such as buttons, IO fields and alarm windows. Touch objects are basically operated in the same way as conventional keys. You operate touch objects by touching them with your finger.

The project may contain operations which require in-depth, device-specific information from the operator and must be executed with particular care, for example, simulation of jog mode. Further information on this may be available in your plant documentation.

 CAUTION
Never touch more than one object on the screen. Never touch more than one touch object at a time, otherwise you may trigger unintentional actions.
CAUTION
Do not use any pointed or sharp objects when operating the touch screen in order to avoid damage to its plastic screen membrane.

Operation feedback

The HMI device provides optical feedback when it detects the operation of a touch object. This feedback is independent of any communication with the PLC. Therefore, this feedback does not indicate whether the relevant action is actually executed or not.

The configuration engineer may also have configured the feedback function in a different manner. Further information on this may be available in your plant documentation.

Optical feedback

The type of optical feedback depends on the operator control object:

- Buttons

The HMI device outputs different views of the "Touched" and "Untouched" states, provided the configuration engineer has configured a 3D effect:

– "Touched" state:



– "Untouched" state:



The configuration engineer defines the appearance of a selected field, for example, its line width and color for the focus.

- Invisible buttons

The focus for invisible buttons is not identified after selection by default.

The configuration engineer may, however, configure invisible buttons so that their outline appears when touched. This outline remains visible until the you select another operator control object.

- IO fields

After you touch an IO field, a screen keyboard appears as feedback.

8.2.2 Setting the project language

Introduction

The HMI device supports multilingual projects. You need to configure a corresponding operator control object which lets you change the language setting on the HMI device during runtime.

The project always starts with the language set in the previous session.

Requirements

- The relevant project language must be available on the HMI device.
- The language changeover function must be logically linked to a configured operator control object such as a button.

Selecting a language

You can change project languages at any time. Language-specific objects are immediately output to the screen in the relevant language when you switch languages.

The following options are available for switching the language:

1. A configured operator control object switches from one project language to the next in a list.
2. A configured operator control directly sets the desired project language.

Further information on this may be available in your plant documentation.

8.2.3 Entries and help within a project

8.2.3.1 Overview

Procedure

Values are entered in the project input fields. The values are transferred from the input fields to the PLC.

Proceed as follows:

1. Touch the input field required on the screen.

The screen keyboard opens.

Based on your configuration, you can enter the following type of values in the input field:

- Numerical
- Alphanumerical
- Symbolic
- Date/time

2. Set the value.

3. Confirm the entry.

Screen keyboard

When you touch an input object such as an IO field on the HMI device touch screen, a screen keyboard appears. This screen keyboard is also shown when it is necessary to enter a password to access protected functions. The keyboard is automatically hidden again when input is complete.

Based on the configuration of the input object, the system opens a screen keyboard for entering numerical, alphanumerical or symbolic values.

Note

The screen keyboard display is independent of the configured project language.

Numerical values

You can enter numerical values character by character using the numerical screen keyboard.

Format patterns of numerical values

You can enter values in numerical input fields based on the following formats:

- Decimal
- Hexadecimal
- Binary

Limit value test of numerical values

Tags can be assigned limit values. The current limit values are indicated in the numerical screen keyboard. If an alarm window has been configured, a system alarm is automatically output to indicate any violation of the configured input value limits. For example, 80 exceeds the configured limit value of 78. The entered value is therefore rejected and the original value is displayed again.

Decimal places for numerical values

If a numerical input field is configured for a specific number of decimal points, decimal places in excess of the limit are ignored. Empty decimal places are filled with "0" after the number is confirmed.

Alphanumerical values

Alphanumerical values (numbers and letters) can be entered character by character using the alphanumerical screen keyboard.

Symbolic values

Symbolic values are entered from a list of predefined entries using the symbolic screen keyboard.

Date and time

You can enter date/time values character by character using the alphanumerical screen keyboard.

8.2.3.2 Entering and editing numerical values

Numerical screen keyboard

When you touch an IO field on the HMI device touch screen, the numerical screen keyboard appears. The keyboard is automatically hidden again when input is complete.



Figure 8-4 Numerical screen keyboard

The layout of the screen keyboard for a vertically mounted HMI device differs slightly from that shown in the figure above.

Procedure

You can enter numerical and hexadecimal values character by character using the numerical screen keyboard

Proceed as follows:

1. Touch the relevant IO field on the screen.



The numerical screen keyboard opens and displays the current value.

2. Set the value.

You can only operate keys which are visualized in 3D format. The type of value to be entered determines whether a key is enabled or disabled.

The following options for entering values are available:

- The current value is deleted when you enter the first character. Enter the value again.



- Use the  and  keys to move the cursor within the current value. You can now edit the characters of the current value or add characters.

Use the  key to delete the character to the left of the cursor.

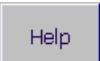
- Use the  key to change the sign of the value.

- Select  to view the infotext of the IO field.

This button is only enabled if infotext has been configured for the IO fields.

3. Select  to confirm your entries or cancel them with . Both actions close the screen keyboard.

Note

Numerical IO fields can be assigned limit values. In this case, values are only accepted if they lie within configured limits. If you enter a value that is outside the configured limits, the system rejects this value and restores the original. The HMI device outputs a system alarm to indicate this situation.

When the screen keyboard appears, the high and low limit values are indicated if configured.

8.2.3.3 Entering and editing alphanumerical values

Alphanumerical screen keyboard

When you touch an IO field on the HMI device touch screen, the alphanumerical screen keyboard appears. The keyboard is automatically hidden again when input is complete.

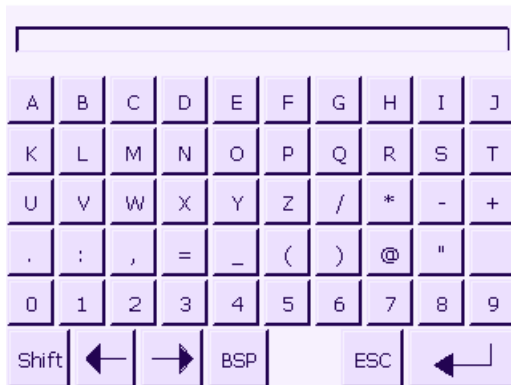

Figure 8-5 Alphanumerical screen keyboard, standard layer

The layout of the screen keyboard for a vertically mounted HMI device differs slightly from that shown in the figure above.

Keyboard layers

The alphanumerical keyboard is organized in several layers:

- Standard layer
- Shift layer

Procedure

You can enter numerical values character by character using the alphanumerical screen keyboard.

Proceed as follows:



1. Touch the relevant IO field on the screen.

The alphanumerical screen keyboard opens and displays the current value.

2. Set the value.

The following options for entering values are available:



- The current value is deleted when you enter the first character. Enter the value again.

- Use the  and  keys to move the cursor within the current value. You can now edit the characters of the current value or add characters.

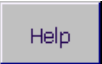
Use the  key to delete the character to the left of the cursor.

- Use the  key to toggle between the Shift layer and standard layer of the keyboard. When you toggle the layer, the key labels on the screen keyboard change.
- Select  to view the infotext of the IO field.

This button is only enabled if infotext has been configured for the IO fields.

3. Select  to confirm your entries or cancel them with . Both actions close the screen keyboard.

8.2.3.4 Entering and editing symbolic values

Symbolic screen keyboard

When you touch a symbolic IO field on the HMI device touch screen, the symbolic screen keyboard appears. The keyboard is automatically hidden again when input is complete.



Figure 8-6 Symbolic screen keyboard

The layout of the screen keyboard for a vertically mounted HMI device differs slightly from that shown in the figure above.

Procedure

Set symbolic values with the help of the symbolic screen keyboard.

Proceed as follows:





1. Touch the relevant IO field on the screen.

The symbolic screen keyboard opens and displays the current value.

2. Select an entry from the selection list.



The following options for selecting the entry are available:

- Position the cursor directly on the entry in the selection list by touching the entry.

- Move the cursor to an entry in the selection list using the , , or  or  keys.

- Select  to view the infotext of the symbolic IO field.

This button is only enabled if infotext has been configured for the symbolic IO field.

3. Select  to confirm your entries or cancel them with . Both actions close the screen keyboard.

8.2.3.5 Entering and modifying date and time

Entering the date and time

Enter the date and time in the same way you enter alphanumerical values.

Note

When entering the date and time, please note that the format is determined by the configured project language.

See also

Entering and editing alphanumerical values (Page 120)

Setting the project language (Page 116)

8.2.3.6 Viewing infotext

Purpose

The configuration engineer uses infotext to provide additional information and operating instructions with respect to screens and operable screen objects.

Infotext can provide information on the value to be entered in an IO field, for example.

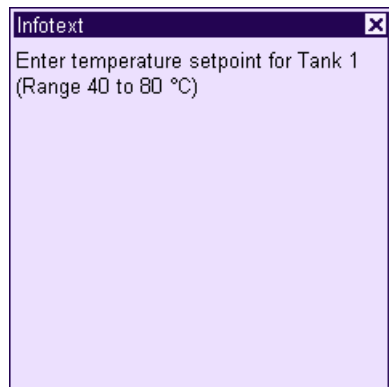
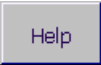

Figure 8-7 Infotext for an IO field, example

Infotext for input objects

Touch the  key on the screen keyboard. This key is only enabled if infotext has been configured for the input object.

Infotext for the current screen

The configuration engineer can also provide infotext for screens. However, the infotext for the current screen is called up by an operator control object assigned to this function and not by the screen keyboard.

Further information on this may be available in your plant documentation.

Closing the infotext

Close the infotext with .

8.2.4 Project security

Overview

Operation of a project can be protected by the configuration engineer by implementing a security system.

If operator control objects protected by a password are operated, the HMI device requests the entry of a password. A logon dialog opens for you to enter the password.

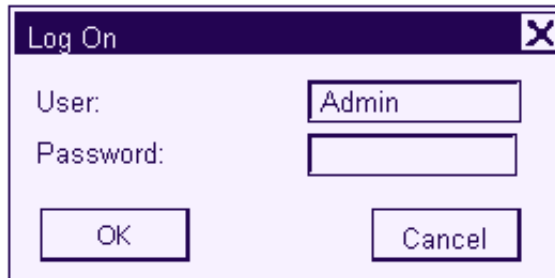

Figure 8-8 Logon dialog

You can use the protected control objects after you completed the logon.

The Logon dialog can be set up by the configuration engineer via an individual operator control object.

In the same way, the configuration engineer can set up an operator control object to log off. After logging off, objects assigned password protection can no longer be operated; to do so, log on again.

Further information on this may be available in your plant documentation.

Logoff time

A user logoff timeout can be set in the system. If the time between any two user actions, e.g, entering a value or changing screens, exceeds this logoff time, the user is automatically logged off. The user must then log on again to continue to operate objects assigned password protection.

Password

The password and logoff timeout values are coded in a list and saved to non-volatile memory on the HMI device.

Note

Depending on the transfer settings, changes to the password list are overwritten when the project is transferred again.

Backup and restore

You can backup the password and restore it using ProSave or WinCC flexible.

NOTICE

On restoring, the currently valid password is overwritten. The restored password is immediately valid.
--

8.2.5 Close the project.

Procedure

Proceed as follows:

1. Use the corresponding operator control object to close the project.
Wait for the Loader to open after you closed the project.
2. Switch off power to the HMI device.

8.2.6 Operating the Trend View

8.2.6.1 Overview

Trends

Trends continuously display the current process data.

Trend View

Trends are displayed in the Trend view. A Trend view can display up to four trends simultaneously. The figure below shows an example of a Trend view:

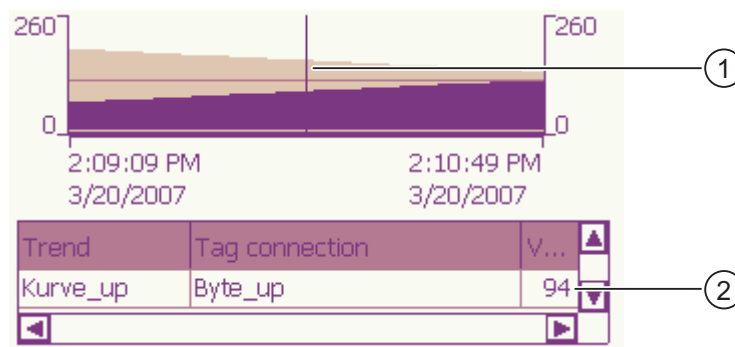

- ① Ruler
- ② Trend value in the value table

The appearance, axes, value range and labels of the Trend view can be set by the configuration engineer.

The configuration engineer can set limits for the trend values. A color transition can be configured when the limits are exceeded.

Further information on this may be available in your plant documentation.

Value Table

The trend values can be read from the value table, if this is configured.

Ruler

The exact trend values can be read from the ruler, if this is configured.

8.2.6.2 Operating the Trend View

Value Table

The trend values are displayed in the value table. When the ruler is displayed, the trend values are shown at a position of the ruler. When the ruler is hidden, the latest trend values are displayed.

Ruler

When configured, a ruler is available to provide an exact reading of the individual values.

The position of the ruler can be changed by touching and dragging it on the touch screen.

The configuration engineer can configure the following actions for operator controls outside the Trend display:

- Display or hide ruler
- Move ruler forward
- Move ruler backward

Further information on this may be available in your plant documentation.

Other Operator Actions

The configuration engineer can configure the following actions for operator controls outside the Trend display:

- Enlarge display of time intervals
- Reduce display of time intervals
- Scroll back by one display width
- Scroll forward by one display width
- Stop or resume trend recording

Further information on this may be available in your plant documentation.

Operating alarms

9.1 Overview

Alarms

Alarms indicate events and states on the HMI device which have occurred in the system, in the process or on the HMI device itself. A status is reported when it is received.

An alarm could trigger one of the following alarm events:

- Activate
- Deactivate
- Acknowledge

The configuration engineer defines which alarms must be acknowledged by the user.

An alarm may contain the following information:

- Date
- Time
- Alarm text
- Location of fault
- Status
- Alarm class
- Alarm number
- Acknowledgement group

Alarm classes

Alarms are assigned to various alarm classes:

- Error
Alarms in this class must always be acknowledged. Alarms normally indicate critical errors within the plant such as "Motor temperature too high".
- Warning
Warning alarms usually indicate states of a plant such as "Motor switched on".
- System
System alarms indicate states or events which occur on the HMI device.
- User-specific alarm classes
The properties of this alarm class must be defined in the configuration.
Further information on this may be available in your plant documentation.

Alarm buffer

Alarm events are saved to an internal, volatile buffer. The size of this alarm buffer depends on the HMI device type.

9.2 Operating alarms on the OP 73micro

9.2.1 Displaying alarms

Alarm view and alarm window

Alarms are indicated in the alarm view or in the alarm window on the HMI device.

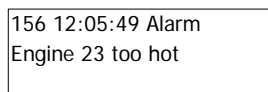

Figure 9-1 Alarm view

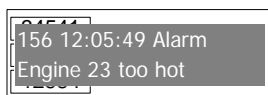

Figure 9-2 Alarm window







The layout and operation of the alarm window correspond to that of the alarm view.

The alarm window is independent of the process screen. Depending on the configuration, the alarm window appears automatically as soon as a new, unacknowledged alarm has been received. The alarm window can be configured so that it only closes after all the alarms have been acknowledged.

Additional information on this may be available in your plant documentation.

Operator control components

Functions of the HMI device keys in the alarm view:

Button	Function
 + 	Show an alarm infotext
	Edit alarm
	Acknowledge alarm
	Show the full text of the selected alarm in a separate window, the alarm text window. You can scroll the alarm text window using the cursor keys.
 , 	Select the next or previous alarm from the alarm view

Alarm class layout

The various alarm classes are identified in order to distinguish between them in the alarm view.

Symbol	Alarm class
!	Error
(empty)	Warning
(depending on the configuration)	User-defined alarm classes
\$	System

The configuration engineer can edit the alarm class symbols. Additional information on this may be available in your plant documentation.

Displaying infotext

An alarm can be assigned an infotext.

Proceed as follows to view the infotext:

1. Select the relevant alarm in the alarm view using the cursor keys.

2. Press  and .

The infotext assigned to this alarm is shown.

3. Press  to close the infotext.



Viewing long alarm text

The alarm text window can be used to view infotexts which can not be output in full length in the alarm view.

1. Select the alarm using the cursor keys.
2. Press .

This opens the alarm text window shown below.

```
502 15:05:49 Alarm
switch off unit 4,
disconnect main linkage,
close by-pass stop valve 2,
start cooling unit 23 and
open pipes 12 and 53,
acknowledge button ACK
```

3. Press  or  to view the full alarm text.
4. Press .

This closes the alarm text window.

Alarm indicator

The alarm indicator is a graphic symbol that shows alarms to be acknowledged.

The following figure shows the alarm indicator:



The alarm indicator flashes as long as alarms are queued for acknowledgment. The alarm indicator is displayed and does not flash as long as acknowledged alarms are still queued. When no alarm is in the queue, the alarm indicator is hidden.

9.2.2 Acknowledging an Alarm

Requirements

- The alarm to be acknowledged is shown in the alarm window or in the alarm view.
- Either the alarm window or the alarm view is enabled.
- The alarm must be acknowledged.

Procedure

Proceed as follows to acknowledge an alarm:

1. From the alarm window or alarm view, select the relevant alarm using the cursor keys.
2. Press .

Result

The alarm or all alarms of the corresponding acknowledgement group are acknowledged.
You may find additional information about acknowledgment groups in your plant documentation.

See also

Displaying alarms (Page 128)

9.2.3 Editing an Alarm

Introduction

The configuration engineer can assign additional functions to each alarm. These functions are executed when the alarm is processed.

Requirements

- The alarm to be edited is indicated in the alarm window or in the alarm view.
- Either the alarm window or the alarm view is enabled.

Procedure

Proceed as follows to edit an alarm:

1. From the alarm view, select the alarm you want to edit using the cursor keys.
2. Press .

Result

The system executes the additional functions of the alarm. You may find additional information on this in your plant documentation.

Note

When you edit an unacknowledged alarm, it is acknowledged automatically.

See also

Displaying alarms (Page 128)

9.3 Operating alarms on the TP 177micro

9.3.1 Displaying alarms

Alarm view and alarm window

Alarms are indicated in the alarm view or in the alarm window on the HMI device.









The layout and operation of the alarm window correspond to that of the alarm view.

The alarm window is independent of the process screen. Depending on the configuration, the alarm window appears automatically as soon as a new, unacknowledged alarm has been received. The alarm window can be configured so that it only closes after all the alarms have been acknowledged.

Further information on this may be available in your plant documentation.

Operator control components

Functions of the alarm view buttons:

Button	Function
	Displays an alarm infotext
	Edits an alarm
	Acknowledges an alarm
	Displays the full text of the selected alarm in a separate window, the alarm text window. If necessary, you can scroll in the alarm text window. In the alarm text window, you can view alarm text that requires more space than is available in the alarm view. Close the alarm text window with  .
	Selects the next or previous alarm from the list.
	Scrolls one page up or down

Alarm class representation

The various alarm classes are identified in order to distinguish between them in the alarm view.

Symbol	Alarm class
!	Error
(empty)	Warning
(depends on the configuration)	User-defined alarm classes
\$	System

The configuration engineer can edit the alarm class symbols. Further information on this may be available in your plant documentation.

Viewing infotext

The configuration engineer can also supply infotext for alarms.

To view an alarm infotext:

1. Select the required alarm in the alarm view.

2. Touch .

The infotext assigned to this alarm is shown.

3. Close the infotext window with .

Alarm indicator

The alarm indicator is a graphical symbol that shows current errors or errors which need to be acknowledged, depending on the configuration.



Figure 9-3 Alarm indicator with three queued alarms

The alarm indicator flashes as long as alarms are queued for acknowledgment. The number indicates the number of queued alarms. The configuration engineer can assign functions to be executed when the alarm indicator is touched.

Usually, the alarm indicator is only used for error alarms. Further information on this may be available in your plant documentation.

9.3.2 Acknowledging an Alarm

Requirements

- The alarm to be acknowledged is shown in the alarm window or in the alarm view.
- Either the alarm window or the alarm view is enabled.
- The alarm must be acknowledged.

Procedure

Proceed as follows to acknowledge an alarm:

1. Select the alarm by touching it in the alarm view or alarm window.
2. Touch .

Result

The alarm or all alarms of the corresponding acknowledgement group are acknowledged.

You may find additional information about acknowledgment groups in your plant documentation.

See also

Displaying alarms (Page 132)

9.3.3 Editing an Alarm

Introduction

The configuration engineer can assign additional functions to each alarm. These functions are executed when the alarm is processed.

Requirements

- The alarm to be edited is indicated in the alarm window or in the alarm view.
- Either the alarm window or the alarm view is enabled.

Procedure

Proceed as follows to edit an alarm:

1. Select the alarm by touching it in the alarm view or alarm window.
2. Touch .

Result

The system executes the additional functions of the alarm. Further information on this may be available in your plant documentation.

Note

When you edit an unacknowledged alarm, it is acknowledged automatically.

See also

Displaying alarms (Page 132)

Maintenance and servicing

10.1 Maintenance and service

Scope of maintenance

The HMI device is designed for maintenance-free operation. Despite this, the touch screen or keyboard membrane and the display must be cleaned regularly.

Preparation

 CAUTION

Faulty operation

Always switch off the HMI device before cleaning it. This will ensure that you do not trigger unintended functions when you touch the keys.

Use a cloth dampened with a cleaning agent to clean the equipment. Only use water with a little liquid soap or a screen cleaning foam.

Procedure

Never spray the cleaning agent directly onto the HMI device. Apply it to a cloth. Never use aggressive solvents or scouring powder.

CAUTION

Do not clean the HMI device with compressed air or steam jet blowers.

10.1.1 Cleaning screen

Cleaning screen

Only applies to HMI devices with touch screen.

The HMI device touch screen can be cleaned when it is switched on and a project is running. The configuration engineer must configure an operator control object for calling the Cleaning Screen. Once the Cleaning Screen is activated, touch screen operation is locked for a configurable period of time. The configuration engineer can lock the touch screen for a duration between 5 and 30 seconds. The time remaining for the lock out is indicated by a progress bar.

 WARNING
Locking operator control objects Always open the Cleaning Screen or switch off the HMI device, before you clean the touch screen while the system is running! Pay attention to the end of the operating lock by the Cleaning Screen function. Ignoring this instruction may lead to inadvertent wrong operation.

10.1.2 Protective membrane

Protective membrane

A protective membrane is available for the HMI device touch screens. The relevant ordering information is provided in the Siemens Catalog ST 80. The protective membrane is not included in the HMI device package.

The self-adhesive membrane prevents the screen from being scratched and soiled. The mat surface of the membrane reduces reflections under unfavorable lighting conditions.

The protective membrane can be removed without leaving any adhesive residue on the screen.

CAUTION
Removing the protective membrane Never use sharp or pointed tools, such as a knife, to remove the protective membrane. This may damage the touch screen.

10.2 Servicing and spare parts

Repairs

A defective device must be returned to the manufacturer's site for repair. The HMI device may only be repaired at the manufacturer's site.

Service pack

A service pack can be ordered for servicing purposes. It contains the following spare parts:

- Mounting seal
- Mounting clamps
- Terminal block (twin block)

The service pack can be ordered from your Siemens representative.

Specifications

11.1 Dimensional drawings

11.1.1 Dimensional drawings, OP 73micro

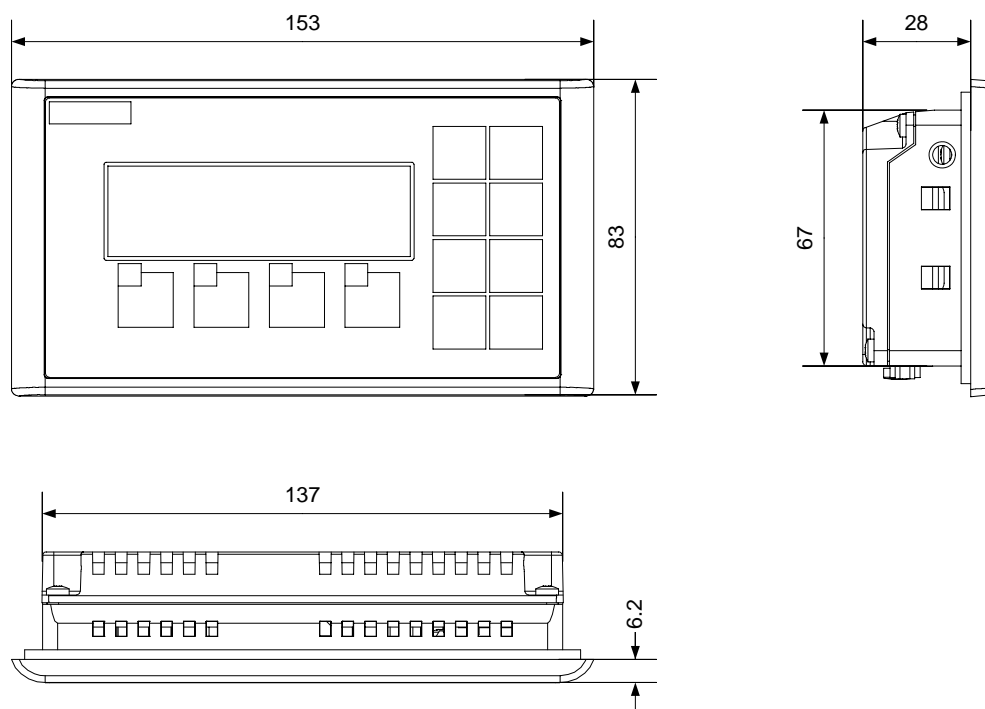

Figure 11-1 Overall dimensions of the HMI device

11.1.2 Dimensional drawings, TP 177micro

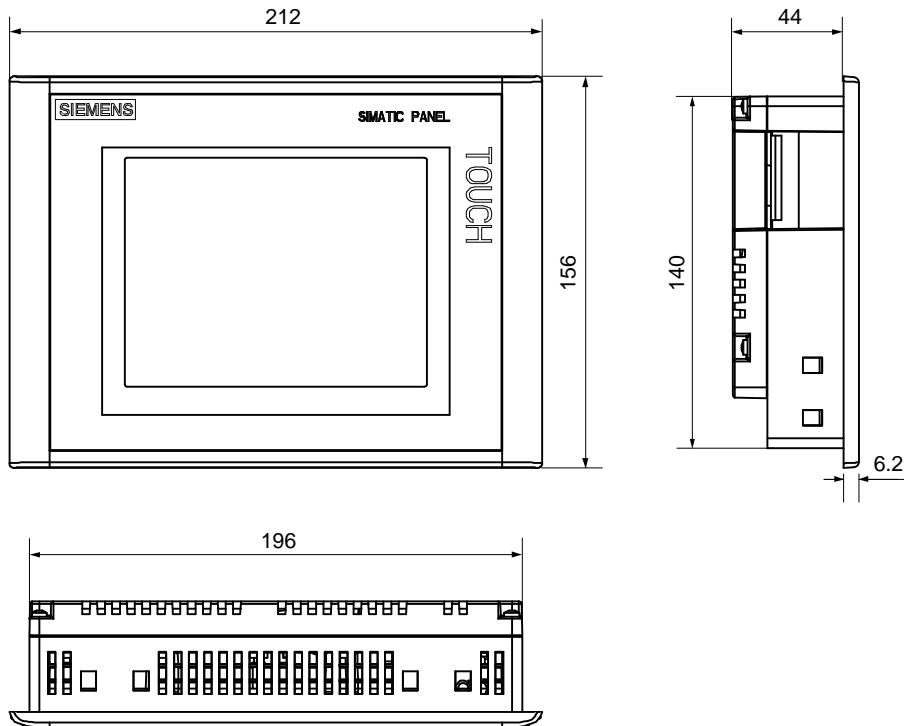

Figure 11-2 Overall dimensions of the HMI device

11.2 Specifications

11.2.1 Specifications of the OP 73micro

Housing

Weight without packing	Approx. 250 g
------------------------	---------------

Display

Type	LCD STN
Display area, active	79.98 mm x 23.98 mm (3")
Resolution	160 x 48 pixels
Colors, displayable	2
Contrast control	yes
Back-lighting	LED green
Half Brightness Life, typical	100 000 h

Input unit

Type	Membrane keyboard
System keys with dedicated functions	8
Soft keys	4
Of those freely configurable	4

Memory

Working memory	128 KB
----------------	--------

Power supply

Nominal voltage	+24 V DC
Range, permissible	20.4 V to 28.8 V (-15%, +20%)
Transients, maximum permissible	35 V (500 msec)
Time between two transients, minimum	50 s
Current consumption at nominal power	
<ul style="list-style-type: none"> • Typical • Constant current, maximum • Power on current surge I²t 	<ul style="list-style-type: none"> • Approx. 80 mA • Approx. 210 mA • Approx. 0.5 A²s
Fuse, internal	Electronic

See also

Standards, Certificates and Approvals (Page 18)

Electromagnetic compatibility (Page 23)

Transport and storage conditions (Page 25)

Mounting information (Page 27)

Mounting positions and fixation (Page 30)

Information on insulation tests, protection class and degree of protection (Page 37)

11.2.2 Specifications of the TP 177micro

Enclosure

Weight without packing	Approx. 750 g
------------------------	---------------

Display

Type	LCD-STN, blue mode
Display area, active	115.18 mm x 86.38 mm (5.7")
Resolution	320 x 240 pixels, 240 x 320 in vertical mounting position
Colors, displayable	4 grades of blue
Contrast control	Yes
Back-lighting Half Brightness Life, typical	CCFL 50,000 h

Input unit

Type	Touch screen, resistive
------	-------------------------

Memory

Working memory	256 KB
----------------	--------

Power supply

Nominal voltage	+24 V DC
Range, permissible	20.4 V to 28.8 V (-15%, +20%)
Transients, maximum permissible	35 V (500 msec)
Time between two transients, minimum	50 s
Current consumption at nominal power <ul style="list-style-type: none"> • Typical • Constant current, maximum • Power on current surge I²t 	<ul style="list-style-type: none"> • Approx. 240 mA • Approx. 300 mA • Approx. 0.5 A²s
Fuse, internal	Electronic

See also

- Standards, Certificates and Approvals (Page 18)
- Electromagnetic compatibility (Page 23)
- Transport and storage conditions (Page 25)
- Mounting information (Page 27)
- Mounting positions and fixation (Page 33)
- Information on insulation tests, protection class and degree of protection (Page 37)

11.3 Description of interfaces

11.3.1 Power supply

Plug connector, 2-pin



Figure 11-3 Power supply pin assignment

PIN	Assignment
1	+24 V DC
2	GND 24 V

11.3.2 RS485 (IF 1B) on OP 73micro

Sub-d socket, 9-pin, with screw lock

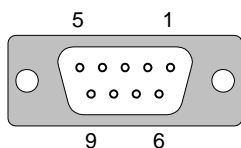

Figure 11-4 RS485 interface pin-out

PIN	Assignment
1	n. c.
2	GND 24 V
3	Data channel B (+)
4	RTS
5	GND 5 V
6	+5 V DC
7	24 V DC, out (max. 100 mA) or 24 V DC in ¹
8	Data channel A (-)
9	n. c.

¹ Applies when power is supplied from the CPU

CAUTION

Power supply

When the HMI device is supplied with power from the CPU, do not connect an external power supply to it.

11.3.3 RS 485 (IF 1B) on TP 177micro

Sub-d socket, 9-pin, with screw lock

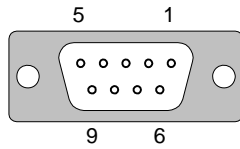

Figure 11-5 RS 485 interface pin assignment

PIN	Assignment
1	n. c.
2	GND 24 V
3	Data channel B (+)
4	RTS
5	GND 5 V
6	+5 V DC
7	+24 V DC, out (max. 100 mA)
8	Data channel A (-)
9	n. c.

Appendix

A.1 ESD Directives

What does ESD mean?

All electronic modules are equipped with highly integrated modules or components. Based on their design, these electronic components are highly sensitive to overvoltage and thus to discharge of static electricity. These electronic components are therefore specially identified as ESD.

Abbreviation

The following abbreviations are commonly used for electrostatic sensitive devices:

- ESD – **E**lectrostatic **S**ensitive **D**evelopments
- ESD – **E**lectrostatic **S**ensitive **D**evice as common international designation

Labeling

ESD modules are labeled with the following symbol:



Figure A-1 ESD label

Electrostatic charge

CAUTION

Electrostatic charge

ESDs may be destroyed by voltages well below the perception threshold of persons. Voltages of this kind develop when a component or an assembly is touched by a person who is not grounded against static electricity. Usually, it is unlikely that damage to an ESD as a result of overvoltage is detected immediately but may become apparent only after a longer period of operation.

Prevent electrostatic charge of your body before you touch the ESD!

Anyone who is not connected to the electrical potential of their surroundings is subjected to electrostatic charge.

The figure indicates the maximum electrostatic charge anyone is subjected to when contacting the materials shown. These values correspond with specifications to IEC 801-2.

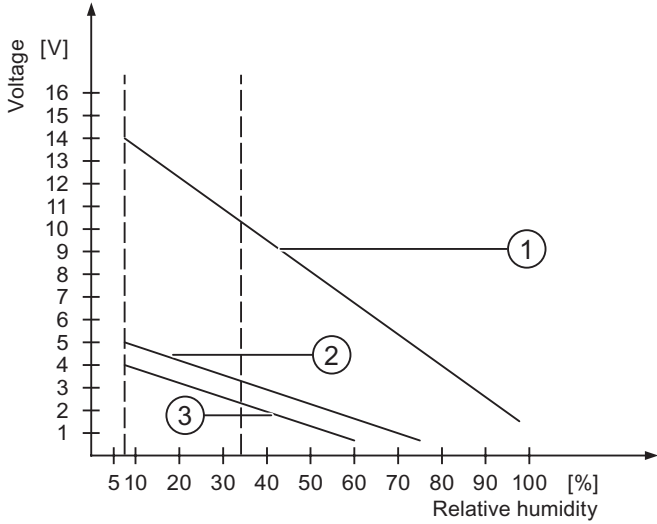

Figure A-2 Electrostatic voltages with which a person can be charged.

- ① Synthetic materials
- ② Wool
- ③ Antistatic materials such as wood or concrete

Protective measures against discharge of static electricity

CAUTION
Grounding measures When working with electrostatic sensitive devices, make sure that the person, the workplace and the packaging are properly grounded. This helps to avoid electrostatic charge.

As a rule, only touch the ESD if this is unavoidable. Example: for maintenance. When you touch modules, make sure that you do not touch the pins on the modules or the PCB tracks. This prevents any discharge of static electricity to sensitive component and thus avoids damage.

Discharge electrostatic electricity from your body if you are performing measurements on an ESD. To do so, touch a grounded metallic object.

Always use grounded measuring instruments.

A.2 System alarms

Introduction

System alarms on the HMI device provide information about internal states of the HMI device and PLC.

The overview below shows the causes of system alarms and how to eliminate the cause of error.

Depending on functionality, only parts of the system alarms described in this section apply to the various HMI devices.

Note

System alarms are only indicated if an alarm window was configured. System alarms are output in the language currently set on your HMI device.

System alarm parameters

System alarms may contain encrypted parameters which are relevant to troubleshooting because they provide a reference to the source code of the Runtime software. These parameters are output after the text "Error code:"

Meaning of the system alarms

Number	Effect/cause	Remedy
10000	The print job could not be started or was canceled due to an unknown error. Faulty printer setup. Or: Access to the network printer is not allowed. Power supply failure during data transfer.	Check the printer settings, cable connections and the power supply. Set up the printer once again. Obtain a network printer authorization. If the error persists, contact the Hotline!
10001	No printer is installed or a default printer has not been set up.	Install a printer and/or select it as the default printer.
10002	Overflow of the graphics buffer for printing. Up to two images are buffered.	Allow sufficient intervals between successive print jobs.
10003	Images can now be buffered again.	-
10004	Overflow of the buffer for printing lines in text mode (e.g.alarms). Up to 1000 lines are buffered.	Allow sufficient intervals between successive print jobs.
10005	Text lines can now be buffered again.	-
10006	The Windows printing system reports an error. Refer to the output text and the error ID to determine the possible causes. Nothing is printed or the print is faulty.	Repeat the action if necessary.
20010	An error has occurred in the specified script line. Execution of the script was therefore aborted. Note the system alarm that may have occurred prior to this.	Select the specified script line in the configuration. Ensure that the tags used are of the allowed types. Check system functions for the correct number and types of parameters.
20011	An error has occurred in a script that was called by the specified script. Execution of the script was therefore aborted in the called script. Take the system alarm that may have occurred prior to this into account.	In the configuration, select the script that has been called directly or indirectly by the specified script. Ensure that the tags used are of the allowed types. Check the system functions for the correct number and type of parameters.
20012	The configuration data is inconsistent. The script could therefore not be generated.	Recompile the configuration.
20013	The scripting component of WinCC flexible Runtime is not correctly installed. Therefore, no scripts can be executed.	Reinstall WinCC flexible Runtime.
20014	The system function returns a value that is not written in any return tag.	Select the specified script in the configuration. Check if the script name has been assigned a value.
20015	Too many successive scripts have been triggered in short intervals. When more than 20 scripts are queued for processing, any subsequent scripts are rejected. In this case, the script indicated in the alarm is not executed.	Find what is triggering the scripts. Extend the times, e.g. the polling time of the tags which trigger the scripts.
30010	The tag could not accept the function result, e.g. when it has exceeded the value range.	Check the tag type of the system function parameter.
30011	A system function could not be executed because the function was assigned an invalid value or type in the parameter.	Check the parameter value and tag type of the invalid parameter. If a tag is used as a parameter, check its value.
40010	The system function could not be executed since the parameters could not be converted to a common tag type.	Check the parameter types in the configuration.

Number	Effect/cause	Remedy
40011	The system function could not be executed since the parameters could not be converted to a common tag type.	Check the parameter types in the configuration.
50000	The HMI device is receiving data faster than it is capable of processing. Therefore, no further data is accepted until all current data have been processed. Data exchange then resumes.	-
50001	Data exchange has been resumed.	-
60000	This alarm is generated by the "DisplaySystemAlarms" function. The text to be displayed is transferred to the function as a parameter.	-
60010	The file could not be copied in the direction defined because one of the two files is currently open or the source/target path is not available. It is possible that the Windows user has no access rights to one of the two files.	Restart the system function or check the paths of the source/target files. Using Windows NT/2000/XP: The user executing WinCC flexible Runtime must be granted access rights for the files.
60011	An attempt was made to copy a file to itself. It is possible that the Windows user has no access rights to one of the two files.	Check the path of the source/target file. Using Windows NT/2000/XP with NTFS: The user executing WinCC flexible Runtime must be granted access rights for the files.
70010	The application could not be started because it could not be found in the path specified or there is insufficient memory space.	Check if the application exists in the specified path or close other applications.
70011	The system time could not be modified. The error alarm only appears in connection with area pointer "Date/time PC". Possible causes: <ul style="list-style-type: none"> An invalid time was transferred in the job mailbox. The Windows user has no right to modify the system time. If the first parameter in the system alarm is displayed with the value 13, the second parameter indicates the byte containing the incorrect value.	Check the time which is to be set. Using Windows NT/2000/XP: The user executing WinCC flexible Runtime must be granted the right to change the system time of the operating system.
70012	An error occurred when executing the function "StopRuntime" with the option "Runtime and operating system". Windows and WinCC flexible Runtime are not closed. One possible cause is that other programs cannot be closed.	Close all programs currently running. Then close Windows.
70013	The system time could not be modified because an invalid value was entered. Incorrect separators may have been used.	Check the time which is to be set.
70014	The system time could not be modified. Possible causes: <ul style="list-style-type: none"> An invalid time was transferred. The Windows user has no right to modify the system time. Windows rejects the setting request. 	Check the time which is to be set. Using Windows NT/2000/XP: The user executing WinCC flexible Runtime must be granted the right to change the system time of the operating system.

Number	Effect/cause	Remedy
70015	The system time could not be read because Windows rejects the reading function.	-
70016	An attempt was made to select a screen by means of a system function or job. This is not possible because the screen number specified does not exist. Or: A screen could not be generated due to insufficient system memory.	Check the screen number in the function or job with the screen numbers configured. Assign the number to a screen if necessary.
70017	Date/Time is not read from the area pointer because the address set in the controller is either not available or has not been set up.	Change the address or set up the address in the controller.
70018	Acknowledgment that the password list has been successfully imported.	-
70019	Acknowledgment that the password list has been successfully exported.	-
70020	Acknowledgment for activation of alarm reporting.	-
70021	Acknowledgment for deactivation of alarm reporting.	-
70022	Acknowledgment to starting the Import Password List action.	-
70023	Acknowledgment to starting the Export Password List action.	-
70024	The value range of the tag has been exceeded in the system function. The calculation of the system function is not performed.	Check the desired calculation and correct it if necessary.
70025	The value range of the tag has been exceeded in the system function. The calculation of the system function is not performed.	Check the desired calculation and correct it if necessary.
70026	No other screens are stored in the internal screen memory. No other screens can be selected.	-
70027	The backup of the RAM file system has been started.	-
70028	The files from the RAM have been copied in the Flash memory. The files from the RAM have been copied in the Flash memory. Following a restart, these saved files are copied back to the RAM file system.	-
70029	Backup of the RAM file system has failed. No backup copy of the RAM file system has been made.	Check the settings in the "Control Panel > OP" dialog and save the RAM file system using the "Save Files" button in the "Persistent Storage" tab.
70030	The parameters configured for the system function are faulty. The connection to the new controller was not established.	Compare the parameters configured for the system function with the parameters configured for the controllers and correct them as necessary.
70031	The controller configured in the system function is not an S7 controller. The connection to the new controller was not established.	Compare the S7 controller name parameter configured for the system function with the parameters configured for the controller and correct them as necessary.

Number	Effect/cause	Remedy
70032	The object configured with this number in the tab order is not available in the selected screen. The screen changes but the focus is set to the first object.	Check the number of the tab order and correct it if necessary.
70033	An e-mail cannot be sent because a TCP/IP connection to the SMTP server no longer exists. This system alarm is generated only at the first attempt. All subsequent unsuccessful attempts to send an e-mail will no longer generate a system alarm. The event is regenerated when an e-mail has been successfully sent in the meantime. The central e-mail component in WinCC flexible Runtime attempts, in regular intervals (1 minute), to establish the connection to the SMTP server and to send the remaining e-mails.	Check the network connection to the SMTP server and re-establish it if necessary.
70034	Following a disruption, the TCP/IP connection to the SMTP server could be re-established. The queued e-mails are then sent.	-
70035	The e-mail queue of the central component in WinCC flexible Runtime responsible for sending e-mails is full. The e-mail could therefore not be entered into the queue and therefore not sent. The cause may be a broken connection to the SMTP server or an overload resulting from too much e-mail traffic. This system alarm is generated only at the first attempt. The next system alarm is only generated when at least one e-mail has been successfully sent to the queue in the meantime.	Check if <ul style="list-style-type: none"> the network connection still exists or the connection is overloaded (for example, due to reoccurring system alarms resulting from disruptions).
70036	No SMTP server for sending e-mails is configured. An attempt to connect to an SMTP server has failed and it is not possible to send e-mails. WinCC flexible Runtime generates the system alarm after the first attempt to send an e-mail.	Configure an SMTP server: In WinCC flexible Engineering System using "Device settings > Device settings" In the Windows CE operating system using "Control Panel > Internet Settings > E-mail > SMTP Server"
70037	An e-mail cannot be sent for unknown reasons. The contents of the e-mail are lost.	Check the e-mail parameters (recipient etc.).
70038	The SMTP server has rejected sending or forwarding an e-mail because the domain of the recipient is unknown to the server or because the SMTP server requires authentication. The contents of the e-mail are lost.	Check the domain of the recipient address or deactivate the authentication on the SMTP server if possible. SMTP authentication is currently not used in WinCC flexible Runtime.
70039	The syntax of the e-mail address is incorrect or contains illegal characters. The contents of the e-mail are discarded.	Check the e-mail address of the recipient.
70040	The syntax of the e-mail address is incorrect or contains illegal characters.	-
80001	The log specified is filled to the size defined (in percent) and must be stored elsewhere.	Store the file or table by executing a 'move' or 'copy' function.
80002	A line is missing in the specified log.	-

Number	Effect/cause	Remedy
80003	The copying process for logging was not successful. In this case, it is advisable to check any subsequent system alarms, too.	-
80006	Since logging is not possible, this causes a permanent loss of the functionality.	In the case of databases, check if the corresponding data source exists and start up the system again.
80009	A copying action has been completed successfully.	-
80010	Since the storage location was incorrectly entered in WinCC flexible, this causes a permanent loss of the functionality.	Configure the storage location for the respective log again and restart the system when the full functionality is required.
80012	Log entries are stored in a buffer. If the values are read to the buffer faster than they can be physically written (using a hard disk, for example), overloading may occur and recording is then stopped.	Archive fewer values. Or: Increase the logging cycle.
80013	The overload status no longer applies. Archiving resumes the recording of all values.	-
80014	The same action was triggered twice in quick succession. Since the process is already in operation, the action is only carried out once.	-
80015	This system alarm is used to report DOS or database errors to the user.	-
80016	The logs are separated by the system function "CloseAllLogs" and the incoming entries exceed the defined buffer size. All entries in the buffer are deleted.	Reconnect the logs.
80017	The number of incoming events cause a buffer overflow. This can be caused, for example, by several copying actions being activated at the same time. All copy jobs are deleted.	Stop the copy action.
80018	All connections between WinCC flexible and the logs have been reestablished, for example, after executing the system function "OpenAllLogs". Entries are written into the logs again.	-
80019	The connection between WinCC flexible and all logs were closed, for example, after executing the system function "CloseAllLogs". Entries are written to the buffer and are then written to the logs when a connection is re-established. There is no connection to the storage location and the storage medium may be replaced, for example.	-
80020	The maximum number of simultaneously copy operations has been exceeded. Copying is not executed.	Wait until the current copying actions have been completed, then restart the last copy action.
80021	An attempt was made to delete a log which is still busy with a copy action. Deletion has not been executed.	Wait until the current copying actions have been completed, then restart the last action

Number	Effect/cause	Remedy
80022	An attempt was made to start a sequence log, which is not a sequence log, from a log using the system function "StartSequenceLog". No sequence log file is created.	In the project, check <ul style="list-style-type: none"> • if the "StartSequenceLog" system function was properly configured • if the tag parameters are properly provided with data on the HMI device
80023	An attempt was made to copy a log to itself. The log is not copied.	In the project, check <ul style="list-style-type: none"> • if the "CopyLog" system function was properly configured • if the tag parameters are properly provided with data on the HMI device
80024	The "CopyLog" system function does not allow copying when the target log already contains data ("Mode" parameter). The log is not copied.	Edit the "CopyLog" system function in the project if necessary. Before you initiate the system function, delete the destination log file.
80025	You have canceled the copy operation. Data written up to this point are retained. The destination log file (if configured) is not deleted. The cancellation is reported by an error entry \$RT_ERR\$ at the end of the destination log.	-
80026	This alarm is output after all logs are initialized. Values are written to the logs from then on. Prior to this, no entries are written to the logs, irrespective whether WinCC flexible Runtime is active or not.	-
80027	The internal Flash memory has been specified as the storage location for a log. This is not permissible. No values are written to this log and the log file is not created.	Configure "Storage Card" or a network path as the storage location.
80028	The alarm returns a status report indicating that the logs are currently being initialized. No values are logged until the alarm 80026 is output.	-
80029	The number of logs specified in the alarm could not be initialized. The logs are initialized. The faulty log files are not available for logging jobs.	Evaluate the additional system alarms, related to this alarm which is also generated. Check the configuration, the ODBC (Open Database Connectivity) and the specified drive.
80030	The structure of the existing log file does not match the expected structure. Logging is stopped for this log.	Delete the existing log data manually, in advance.
80031	The log in CSV format is corrupted. The log cannot be used.	Delete the faulty file.
80032	Logs can be assigned events. These are triggered as soon as the log is full. If WinCC flexible Runtime is started and the log is already full, the event is not triggered. The log specified no longer logs data because it is full.	Close WinCC flexible Runtime, delete the log, then restart WinCC flexible Runtime. Or: Configure a button which contains the same actions as the event and press it.
80033	"System Defined" is set in the data log file as the data source name. This causes an error. No data is written to the database logs, whereas the logging to the CSV logs works.	Install MSDE again.

Number	Effect/cause	Remedy
80034	An error has occurred in the initialization of the logs. An attempt has been made to create the tables as a backup. This action was successful. A backup has been made of the tables of the corrupted log file and the cleared log was restarted.	No action is necessary. However, it is recommended to save the backup files or delete them in order to make the space available again.
80035	An error has occurred in the initialization of the logs. An attempt has been made to create backups of the tables and this has failed. No logging or backup has been performed.	It is recommended to save the backups or to delete them in order to release memory.
110000	The operating mode was changed. "Offline" mode is now set.	-
110001	The operating mode was changed. "Online" mode is now set.	-
110002	The operating mode was not changed.	Check the connection to the controllers. Check if the address area for the area pointer 88 "Coordination" in the controller is available.
110003	The operating mode of the specified controller was changed by the system function "SetConnectionMode". The operating mode is now "offline".	-
110004	The operating mode of the specified controller has been changed by the system function "SetConnectionMode". The operating mode is now "online".	-
110005	An attempt was made to use the system function SetConnectionMode to switch the specified controller to "online" mode, although the entire system is in "offline" mode. This changeover is not allowed. The controller remains in "offline" mode.	Switch the complete system to "online" mode, then execute the system function again.
110006	The content of the "project version" area pointer does not match the user version configured in WinCC flexible. WinCC flexible Runtime is therefore closed.	Check: <ul style="list-style-type: none"> the project version entered on the controller the project version entered in WinCC flexible
120000	The trend is not shown because you configured an incorrect axis to the trend or an incorrect trend.	Change the configuration.
120001	The trend is not shown because you configured an incorrect axis to the trend or an incorrect trend.	Change the configuration.
120002	The trend is not displayed because the tag assigned attempts to access an invalid controller address.	Check if the data area for the tag exists in the controller, the configured address is correct and the value range for the tag is correct.
130000	The action was not executed.	Close all other programs. Delete files no longer required from the hard disk.
130001	The action was not executed.	Delete files no longer required from the hard disk.
130002	The action was not executed.	Close all other programs. Delete files no longer required from the hard disk.
130003	No data medium found. The operation is canceled.	Check, for example, if <ul style="list-style-type: none"> the correct data medium is being accessed the data medium is inserted
130004	The data medium is write-protected. The operation is canceled.	Check if access has been made to the correct data carrier. Remove the write protection.

Number	Effect/cause	Remedy
130005	The file is read only. The operation is canceled.	Check if access has been made to the correct file. Edit the file attributes if necessary.
130006	Access to file failed. The operation is canceled.	Check, for example, if <ul style="list-style-type: none"> • the correct file is being accessed • the file exists • another action is preventing simultaneous access to the file
130007	The network connection is interrupted. Data records cannot be saved or read over the network connection.	Check the network connection and eliminate the cause of error.
130008	The storage card is not available. Data records cannot be saved to / read from the storage card.	Insert the storage card.
130009	The specified folder does not exist on the storage card. Any files saved to this directory are not backed up when you switch off the HMI device.	Insert the storage card.
130010	The maximum nesting depth can be exhausted when, for example, a value change in a script results in the call of another script and the second script in turn has a value change that results in the call of yet a further script etc. The configured functionality is not supported.	Check the configuration.
140000	An online connection to the controller is established.	-
140001	The online connection to the controller was shut down.	-
140003	No tag updating or writing is executed.	Check the connection and if the controller is switched on. Check the parameter definitions in the Control Panel using "Set PG/PC interface". Restart the system.
140004	No tag update or write operations are executed because the access point or the module configuration is faulty.	Verify the connection and check if the controller is switched on. Check the access point or the module configuration (MPI, PPI, PROFIBUS) in the Control Panel with "Set PG/PC interface". Restart the system.
140005	No tag updating or writing is executed because the HMI device address is incorrect (possibly too high).	Use a different HMI device address. Verify the connection and check if the controller is switched on. Check the parameter definitions in the Control Panel using "Set PG/PC interface". Restart the system.
140006	No tag updating or writing is executed because the baud rate is incorrect.	Select a different baud rate in WinCC flexible (according to module, profile, communication peer, etc.).

Number	Effect/cause	Remedy
140007	Tag are not updated or written because the bus profile is incorrect (see %1). The following parameter could not be written to the registry: 1: Tslot 2: Tqui 3: Tset 4: MinTsdr 5: MaxTsdr 6: Trdy 7: Tid1 8: Tid2 9: Gap Factor 10: Retry Limit	Check the user-defined bus profile. Check the connection and if the controller is switched on. Check the parameter definitions in the Control Panel using "Set PG/PC interface". Restart the system.
140008	No tag updating or writing is executed because baud rate is incorrect. The following parameters could not be written to the registry: 0: General error 1: Wrong version 2: Profile cannot be written to the registry. 3: The subnet type cannot be written to the registry. 4: The Target Rotation Time cannot be written to the registry. 5: Faulty Highest Address (HSA).	Check the connection and if the controller is switched on. Check the parameter definitions in the Control Panel using "Set PG/PC interface". Restart the system.
140009	Tags are not updated or written because the module for S7 communication was not found.	Reinstall the module in the Control Panel using "Set PG/PC interface".
140010	No S7 communication partner found because the controller is shut down. DP/T: The option "PG/PC is the only master" is not set in the Control Panel under "Set PG/PC interface."	Switch the controller on. DP/T: If only one master is connected to the network, disable "PG/PC is the only master" in "Set PG/PC interface". If several masters are connected to the network, enable these. Do not change any settings, for this will cause bus errors.
140011	No tag updating or writing is executed because communication is down.	Check the connection and that the communication partner is switched on.
140012	There is an initialization problem (e.g. when WinCC flexible Runtime was closed in Task Manager). Or: Another application (e.g. STEP7) with different bus parameters is active and the driver cannot be started with the new bus parameters (transmission rate, for example).	Restart the HMI device. Or: Run WinCC flexible Runtime, then start your other applications.
140013	The MPI cable is disconnected and, thus, there is no power supply.	Check the connections.
140014	The configured bus address is in already in use by another application.	Edit the HMI device address in the controller configuration.
140015	Wrong transmission rate Or: Faulty bus parameters (e.g.HSA) Or: OP address > HSA or: Wrong interrupt vector (interrupt does not arrive at the driver)	Correct the relevant parameters.

Number	Effect/cause	Remedy
140016	The hardware does not support the configured interrupt.	Change the interrupt number.
140017	The set interrupt is in use by another driver.	Change the interrupt number.
140018	The consistency check was disabled by SIMOTION Scout. Only a corresponding note appears.	Enable the consistency check with SIMOTION Scout and once again download the project to the PLC.
140019	SIMOTION Scout is downloading a new project to the controller. Connection to the controller is canceled.	Wait until the end of the reconfiguration.
140020	The version in the controller and that of the project (FWX file) do not match. Connection to the controller is canceled	The following remedies are available: Download the current version to the PLC using SIMOTION Scout. Regenerate the project using WinCC flexible ES, close WinCC flexible Runtime and restart with a new configuration.
150000	No more data is read or written. Possible causes: <ul style="list-style-type: none"> • The cable is defective. • The PLC does not respond, is defective, etc. • The wrong port is used for the connection. • System overload. 	Ensure that the cable is plugged in, the controller is operational, the correct interface is being used. Restart the system if the system alarm persists.
150001	Connection is up because the cause of the interruption has been eliminated.	-
160000	No more data is read or written. Possible causes: <ul style="list-style-type: none"> • The cable is defective. • The PLC does not respond, is defective, etc. • The wrong port is used for the connection. • System overload. 	Ensure that the cable is plugged in, the controller is operational, the correct interface is being used. Restart the system if the system alarm persists.
160001	Connection is up because the cause of the interruption has been eliminated.	-
160010	No connection to the server because the server identification (CLS-ID) cannot be determined. Values cannot be read or written.	Check access rights.
160011	No connection to the server because the server identification (CLS-ID) cannot be determined. Values cannot be read or written.	Check, for example, if <ul style="list-style-type: none"> • the server name is correct • the computer name is correct • the server is registered
160012	No connection to the server because the server identification (CLS-ID) cannot be determined. Values cannot be read or written.	Check, for example, if <ul style="list-style-type: none"> • the server name is correct • the computer name is correct • the server is registered Note for advanced users: Interpret the value from HRESULT.
160013	The specified server was started as InProc server. This has not been released and may possibly lead to incorrect behavior because the server is running in the same process area as the WinCC flexible Runtime software.	Configure the server as OutProc Server or Local Server.

Number	Effect/cause	Remedy
160014	Only one OPC server project can be started on a PC/MP. An alarm is output when an attempt is made to start a second project. The second project has no OPC server functionality and cannot be located as an OPC server by external sources.	Do not start a second project with OPC server functionality on the computer.
170000	S7 diagnostics events are not indicated because it is not possible to log on to the S7 diagnostics functions at this device. The service is not supported.	-
170001	The S7 diagnostics buffer cannot be viewed because communication with the controller is shut down.	Set the controller to online mode.
170002	The S7 diagnostics buffer cannot be viewed because reading of the diagnostics buffer (SSL) was canceled with error.	-
170003	An S7 diagnostics event cannot be visualized. The system returns internal error %2.	-
170004	An S7 diagnostics event cannot be visualized. The system returns an internal error of error class %2, error number %3.	-
170007	It is not possible to read the S7 diagnostics buffer (SSL) because this operation was canceled with an internal error of class %2 and error code %3.	-
180000	A component/OCX received configuration data with a version ID which is not supported.	Install a newer component.
180001	System overload because too many actions running in parallel. Not all the actions can be executed, some are rejected.	Several remedies are available: <ul style="list-style-type: none"> • Increase the configured cycle times or basic clock. • Generate the alarms at a slower rate (polling). • Initiate scripts and functions at greater intervals. If the alarm appears more frequently: Restart the HMI device.
180002	The on-screen keyboard could not be activated. Possible causes: "TouchInputPC.exe" was not registered due to a faulty Setup.	Reinstall WinCC flexible Runtime.
190000	It is possible that the tag is not updated.	-
190001	The tag is updated after the cause of the last error state has been eliminated (return to normal operation).	-
190002	The tag is not updated because communication with the controller is down.	Select the system function "SetOnline" to go online.
190004	The tag is not updated because the configured tag address does not exist.	Check the configuration.
190005	The tag is not updated because the configured controller type does not exist for this tag.	Check the configuration.
190006	The tag is not updated because it is not possible to map the controller type in the data type of the tag.	Check the configuration.

Number	Effect/cause	Remedy
190007	The tag value is not modified because the connection to the controller is interrupted or the tag is offline.	Set online mode or reconnect to the controller.
190008	The threshold values configured for the tag have been violated, for example, by <ul style="list-style-type: none"> • a value entered • a system function • a script 	Observe the configured or current threshold values of the tag.
190009	An attempt has been made to assign the tag a value which is outside the permitted range of values for this data type. For example, a value of 260 was entered for a byte tag or a value of -3 for an unsigned word tag.	Observe the range of values for the data type of the tags.
190010	Too many values are written to the tag (for example, in a loop triggered by a script). Values are lost because only up to 100 actions are saved to the buffer.	Increase the time interval between multiple write actions.
190011	Possible cause 1: The value entered could not be written to the configured controller tag because the high or low limit was exceeded. The system discards the entry and restores the original value. Possible cause 2: The connection to the controller was interrupted.	Make sure that the value entered lies within the range of values of the control tags. Check the connection to the PLC.
190012	It is not possible to convert a value from a source format to a target format, for example: An attempt is being made to assign a value to a counter that is outside the valid, PLC-specific value range. A tag of the type Integer should be assigned a value of the type String.	Check the range of values or the data type of the tags.
190100	The area pointer is not updated because the address configured for this pointer does not exist. Type 1 Warning alarms 2 Error alarms 3 Controller acknowledgment 4 HMI device acknowledgment 5 LED mapping 6 Trend request 7 Trend transfer 1 8 Trend transfer 2 No.: consecutive number shown in WinCC flexible ES.	Check the configuration.
190101	The area pointer is not updated because it is not possible to map the PLC type to the area pointer type. Parameter type and no.: see alarm 190100	-

Number	Effect/cause	Remedy
190102	The area pointer is updated after the cause of the last error state has been eliminated (return to normal operation). Parameter type and no.: See alarm 190100.	-
200000	Coordination is not executed because the address configured in the controller does not exist/is not set.	Change the address or set up the address in the controller.
200001	Coordination is canceled because the write access to the address configured in the PLC is not possible.	Change the address or set the address in the controller at an area which allows write access.
200002	Coordination is not carried out at the moment because the address format of the area pointer does not match the internal storage format.	Internal fault
200003	Coordination can be executed again because the last error state is eliminated (return to normal operation).	-
200004	The coordination may not be executed.	-
200005	No more data is read or written. Possible causes: <ul style="list-style-type: none"> • The cable is defective. • The PLC does not respond, is defective, etc. • System overload. 	Ensure that the cable is plugged in and the controller is operational. Restart the system if the system alarm persists.
200100	Coordination is not executed because the address configured in the controller does not exist/is not set.	Change the address or set up the address in the controller.
200101	Coordination is canceled because the write access to the address configured in the PLC is not possible.	Change the address or set the address in the controller at an area which allows write access.
200102	Coordination is not carried out at the moment because the address format of the area pointer does not match the internal storage format.	Internal fault
200103	Coordination can be executed again because the last error state is eliminated (return to normal operation).	-
200104	The coordination may not be executed.	-
200105	No more data is read or written. Possible causes: <ul style="list-style-type: none"> • The cable is defective. • The PLC does not respond, is defective, etc. • System overload. 	Ensure that the cable is plugged in and the controller is operational. Restart the system if the system alarm persists.
210000	Jobs are not processed because the address configured in the controller does not exist/has not been set up.	Change the address or set up the address in the controller.
210001	Jobs are not processed because read/write access to the address configured in the controller is not possible.	Change the address or set up the address in the controller in an area which allows read/write access.
210002	Jobs are not executed because the address format of the area pointer does not match the internal storage format.	Internal fault
210003	The job buffer is processed again because the last error status has been eliminated (return to normal operation).	-

Number	Effect/cause	Remedy
210004	It is possible that the job buffer will not be processed.	-
210005	A control request with an illegal number was initiated.	Check the controller program.
210006	An error occurred while attempting to execute the control request. As a result, the control request is not executed. Observe the next/previous system alarms.	Check the parameters of the control request. Recompile the configuration.
220001	The tag is not downloaded because the associated communication driver / HMI device does not support the download of Boolean/discrete data types.	Change the configuration.
220002	The tag is not downloaded because the associated communication driver / HMI device does not support write access to the data type BYTE.	Change the configuration.
220003	The communication driver cannot be loaded. The driver may not be installed.	Install the driver by reinstalling WinCC flexible Runtime.
220004	Communication is down and no update data is transferred because the cable is not connected or defective etc.	Check the connection.
220005	Communication is up.	-
220006	The connection between the specified PLC and the specified port is active.	-
220007	The connection to the specified controller is interrupted at the specified port.	Check if <ul style="list-style-type: none"> • the cable is plugged in • the controller is OK • the correct port is used • the configuration is OK (interface parameters, protocol settings, PLC address). Restart the system if the system alarm persists.
220008	The communication driver cannot access or open the specified port. The port may be in use by another application or the port used is not available on the destination device. There is no communication with the controller.	Close all the applications which access this port and restart the computer. Use another port of the system.
230000	The value entered could not be accepted. The entered value is discarded and the previous value is restored. Either the value range has been exceeded or impermissible characters were entered.	Enter a permissible value.
230002	The currently logged on user is not granted write access rights. The system therefore discards the input and restored the previous value.	Log on as a user with appropriate rights.
230003	Changeover to the specified screen failed because the screen is not available/configured. The current screen remains selected.	Configure the screen and check the screen selection function.
230005	The value range of the tag has been exceeded in the IO field. The original value of the tag is retained.	Observe the range of values for the tag when entering a value.

Number	Effect/cause	Remedy
230100	During navigation in the web browser, the system returned a message which may be of interest to the user. The web browser continues to run but may not (fully) show the new page.	Navigate to another page.
230200	The connection to the HTTP channel was interrupted due to an error. This error is explained in detail by another system alarm. Data is no longer exchanged.	Check the network connection. Check the server configuration.
230201	The connection to HTTP channel was established. Data is exchanged.	-
230202	WININET.DLL has detected an error. This error usually occurs when an attempt to connect to the server fails or the server refuses to connect because the client lacks the proper authorization. An unknown server certificate may also be the cause if the connection is encrypted by means of SSL. The alarm text provides details. This text is always in the language of the Windows installation because it is returned by the Windows OS. Process values are no longer exchanged.	Depending on the cause: When an attempt to connect fails or a timeout error occurs: <ul style="list-style-type: none"> • Check the network connection and the network. • Check the server address. • Check if the web server is actually running on the destination computer. Faulty authorization: <ul style="list-style-type: none"> • The configured user name and/or password do not match those on the server. Establish consistency. When the server certificate is rejected: Certificate signed by an unknown CA (): <ul style="list-style-type: none"> • Either ignore this item in your project, or • Install a certificate that has been signed with a root certificate known to the client computer. The date of the certificate is invalid: <ul style="list-style-type: none"> • Either ignore this item in your project, or • Install a certificate with a valid date on the server. Invalid CN (Common Name or Computer Name): <ul style="list-style-type: none"> • Either ignore this item in your project, or • Install a certificate with a name that corresponds to that of the server address.
230203	Although a connection can be made to the server, the HTTP server refuses to connect because <ul style="list-style-type: none"> • WinCC flexible Runtime is not running on the server, or • the HTTP channel is not supported (503 Service unavailable). Other errors can only occur if the web server does not support the HTTP channel. The language of the alarm text depends on the web server. Data is not exchanged.	Error 503 Service unavailable: Check if WinCC flexible Runtime is running on the server the HTTP channel is supported.
230301	An internal error has occurred. An English text explains the error in more detail. This may be caused by insufficient memory. OCX does not work.	-
230302	The name of the remote server cannot be resolved. The attempt to connect failed.	Check the configured server address. Check if the DNS service is available on the network.

Number	Effect/cause	Remedy
230303	The remote server is not running on the addressed computer. Wrong server address. The attempt to connect failed	Check the configured server address. Check if the remote server is running on the target computer.
230304	The remote server on the addressed computer is incompatible to VNCOCX. The attempt to connect failed.	Use a compatible remote server.
230305	The authentication has failed because the password is incorrect. The attempt to connect failed.	Configure the correct password.
230306	Error in the connection to the remote server. This may occur as a result of network problems. The attempt to connect failed.	Check if <ul style="list-style-type: none"> • the bus cable is plugged in • there are network problems
230307	The connection to the remote server was shut down because <ul style="list-style-type: none"> • the remote server was shut down, or • the user instructed the server to close all connections. The connection is closed.	-
230308	This alarm provides information on the connection status. An attempt is made to connect.	-
240000	WinCC flexible Runtime is operating in demo mode. You have no authorization or your authorization is corrupted.	Install the authorization.
240001	WinCC flexible Runtime is operating in demo mode. Too many tags are configured for the installed version.	Load an adequate authorization / powerpack.
240002	WinCC flexible Runtime is operating with a time-limited emergency authorization.	Restore the full authorization.
240003	Authorization failed. Without authorization, WinCC will run in demo mode.	Restart WinCC flexible Runtime or reinstall it.
240004	Error while reading the emergency authorization. WinCC flexible Runtime is operating in demo mode.	Restart WinCC flexible Runtime, install the authorization or repair the authorization (see Commissioning Instructions Software Protection).
250000	The tag in the specified line in "Status force" is not updated because the address configured for this tag is not available.	Check the set address and then verify that the address is set up in the controller.
250001	The tag in the specified line in "Status force" is not updated because the controller type configured for this tag does not exist.	Check the set address.
250002	The tag in the specified line in "Status force" is not updated because it is not possible to map the controller type in the tag type.	Check the set address.
250003	An attempt to connect to the PLC failed. The tags are not updated.	Check the connection to the PLC. Check that the controller is switched on and is online.
260000	An unknown user or an unknown password has been entered in the system. The current user is logged off from the system.	Log on to the system as a user with a valid password.

Appendix

A.2 System alarms

Number	Effect/cause	Remedy
260001	The logged on user does not have sufficient authorization to execute the protected functions on the system.	Log on to the system as a user with sufficient authorization.
260002	This alarm is triggered by the system function "TrackUserChange".	-
260003	The user has logged off from the system.	-
260004	The user name entered into the user view already exists in the user administration.	Select another user name because user names have to be unique in the user administration.
260005	The entry is discarded.	Use a shorter user name.
260006	The entry is discarded.	Use a shorter or longer password.
260007	The logon timeout value entered is outside the valid range of 0 to 60 minutes. The new value is discarded and the original value is retained.	Enter a logon timeout value between 0 and 60 minutes.
260008	An attempt was made to read a PTProRun.pwl file created with ProTool V 6.0 in WinCC flexible. Reading the file was canceled due to incompatibility of the format.	-
270000	A tag is not indicated in the alarm because it attempts to access an invalid address in the controller.	Check if the data area for the tag exists in the controller, the configured address is correct and the value range for the tag is correct.
270001	There is a device-specific limit as to how many alarms may be queued for output (see the operating instructions). This limit has been exceeded. The view no longer contains all the alarms. However, all alarms are written to the alarm buffer.	-
270002	The view shows alarms of a log for which there is no data in the current project. Wildcards are output for the alarms.	Delete older log data if necessary.
270003	The service cannot be set up because too many devices want to use this service. A maximum of four devices may execute this action.	Reduce the number of HMI devices which want to use the service.
280000	Connection is up because the cause of the interruption has been eliminated.	-
280001	No more data is read or written. Possible causes: <ul style="list-style-type: none"> • The cable is defective. • The PLC does not respond, is defective, etc. • The wrong port is used for the connection. • System overload. 	Check if <ul style="list-style-type: none"> • the cable is plugged in • the controller is OK • the correct port is used Restart the system if the system alarm persists.
280002	The connection used requires a function block in the controller. The function block has responded. Communication is now enabled.	-

Number	Effect/cause	Remedy
280003	The connection used requires a function block in the controller. The function block has not responded.	Check if <ul style="list-style-type: none"> the cable is plugged in the controller is OK the correct port is used Restart the system if the system alarm persists. Remedy depends on the error code: 1: The function block must set the COM bit in the response container. 2: The function block must not set the ERROR bit in the response container. 3: The function block must respond within the specified time (timeout). 4: Go online to the PLC.
280004	The connection to the controller is interrupted. There is no data exchange at present.	Check the connection parameters in WinCC flexible. Ensure that the cable is plugged in, the controller is operational, the correct interface is being used. Restart the system if the system alarm persists.
290000	The recipe tag could not be read or written. It is assigned the start value. The alarm can be entered in the alarm buffer for up to four more failed tags if necessary. After that, alarm 290003 is output.	Check in the configuration that the address has been set up in the controller.
290001	An attempt has been made to assign a value to a recipe tag which is outside the value range permitted for this type. The alarm can be entered in the alarm buffer for up to four more failed tags if necessary. After that, alarm 290004 is output.	Observe the value range for the tag type.
290002	It is not possible to convert a value from a source format to a target format. The alarm can be entered in the alarm buffer for up to four more failed recipe tags if necessary. After that, alarm 290005 is output.	Check the value range or type of the tag.
290003	This alarm is output when alarm number 290000 is triggered more than five times. In this case, no further separate alarms are generated.	Check in the configuration that the tag addresses have been set up in the controller.
290004	This alarm is output when alarm number 290001 is triggered more than five times. In this case, no further separate alarms are generated.	Observe the value range for the tag type.
290005	This alarm is output when alarm number 290002 is triggered more than five times. In this case, no further separate alarms are generated.	Check the value range or type of the tag.
290006	The threshold values configured for the tag have been violated by values entered.	Observe the configured or current threshold values of the tag.

Number	Effect/cause	Remedy
290007	There is a difference between the source and target structure of the recipe currently being processed. The target structure contains an additional data recipe tag which is not available in the source structure. The data recipe tag specified is assigned its start value.	Insert the specified data recipe tag in the source structure.
290008	There is a difference between the source and target structure of the recipe currently being processed. The source structure contains an additional data recipe tag which is not available in the target structure and therefore cannot be assigned. The value is rejected.	Remove the specified data recipe tag in the specified recipe from the project.
290010	The storage location configured for the recipe is not permitted. Possible causes: Illegal characters, write protection, data carrier out of space or does not exist.	Check the configured storage location.
290011	The data record with the specified number does not exist.	Check the source for the number (constant or tag value).
290012	The recipe with the specified number does not exist.	Check the source for the number (constant or tag value).
290013	An attempt was made to save a data record under a data record number which already exists. The action is not executed.	The following remedies are available: <ul style="list-style-type: none"> • Check the source for the number (constant or tag value). • First, delete the data record. • Change the "Overwrite" function parameter.
290014	The file specified to be imported could not be found.	Check: <ul style="list-style-type: none"> • The file name • Ensure that the file is in the specified directory.
290020	Message reporting that the download of data records from the HMI device to the PLC has started.	-
290021	Message reporting that the download of data records from the HMI device to the PLC was completed.	-
290022	Message reporting that the download of data records from the HMI device to the PLC was canceled due to an error.	Check in the configuration whether: <ul style="list-style-type: none"> • The tag addresses are configured in the controller • The recipe number exists • The data record number exist • The "Overwrite" function parameter is set
290023	Message reporting that the download of data records from the PLC to the HMI device has started.	-
290024	Message reporting that the download of data records from the PLC to the HMI device was completed.	-

Number	Effect/cause	Remedy
290025	Message reporting that the download of data records from the PLC to the HMI device was canceled due to an error.	Check in the configuration whether: <ul style="list-style-type: none"> • The tag addresses are configured in the controller • The recipe number exists • The data record number exist • The "Overwrite" function parameter is set
290026	An attempt has been made to read/write a data record although the data record is not free at present. This error may occur in the case of recipes for which downloading with synchronization has been configured.	Set the data record status to zero.
290027	Unable to connect to the controller at present. As a result, the data record can neither be read nor written. Possible causes: No physical connection to the controller (no cable plugged in, cable is defect) or the controller is switched off.	Check the connection to the PLC.
290030	This alarm is output after you selected screen which contains a recipe view in which a data record is already selected.	Reload the data record from the storage location or retain the current values.
290031	While saving, it was detected that a data record with the specified number already exists.	Overwrite the data record or cancel the action.
290032	While exporting data records it was detected that a file with the specified name already exists.	Overwrite the file or cancel the process.
290033	Confirmation request before deleting data records.	-
290040	A data record error with error code %1 that cannot be described in more detail occurred. The action is canceled. It is possible that the data record was not installed correctly on the controller.	Check the storage location, the data record, the "Data record" area pointer and if necessary, the connection to the controller. Restart the action after a short time. If the error persists, contact Customer Support. Forward the relevant error code to Customer Support.
290041	A data record or file cannot be saved because the storage location is full.	Delete files no longer required.
290042	An attempt was made to execute several recipe actions simultaneously. The last action was not executed.	Trigger the action again after waiting a short period.
290043	Confirmation request before storing data records.	-
290044	The data store for the recipe has been destroyed and is deleted.	-
290050	Message reporting that the export of data records has started.	-
290051	Message reporting that the export of data records was completed.	-
290052	Message reporting that the export of data records was canceled due to an error.	Ensure that the structure of the data records at the storage location and the current recipe structure on the HMI device are identical.
290053	Message reporting that the import of data records has started.	-

Appendix

A.2 System alarms

Number	Effect/cause	Remedy
290054	Message reporting that the import of data records was completed.	-
290055	Message reporting that the import of data records was canceled due to an error.	Ensure that the structure of the data records at the storage location and the current recipe structure on the HMI device are identical.
290056	Error when reading/writing the value in the specified line/column. The action was canceled.	Check the specified line/column.
290057	The tags of the recipe specified were toggled from "offline" to "online" mode. Each change of a tag in this recipe is now immediately downloaded to the controller.	-
290058	The tags of the specified recipe were toggled from "offline" to "online" mode. Modifications to tags in this recipe are no longer immediately transferred to the controller but must be transferred there explicitly by downloading a data record.	-
290059	Message reporting that the specified data record was saved.	-
290060	Message reporting that the specified data record memory was cleared.	-
290061	Message reporting that clearing of data record memory was canceled due to an error.	-
290062	The data record number is above the maximum of 65536. This data record cannot be created.	Select another number.
290063	This occurs with the system function "ExportDataRecords" when the parameter "Overwrite" is set to No. An attempt has been made to save a recipe under a file name which already exists. The export is canceled.	Check the "ExportDataRecords" system function.
290068	Request to confirm if all data records in the recipe should be deleted.	-
290069	Request to confirm if all data records of all recipes should really be deleted.	-
290070	The data record specified is not in the import file.	Check the source of the data record number or data record name (constant or tag value).
290071	During the editing of data record values, a value was entered which exceeded the low limit of the recipe tag. The entry is discarded.	Enter a value within the limits of the recipe tag.
290072	When editing data record values, a value was entered which exceeds the high limit of the recipe tag. The entry is discarded.	Enter a value within the limits of the recipe tag.

Number	Effect/cause	Remedy
290073	An action (e.g. saving a data record) failed due to an unknown error. The error corresponds to the status alarm IDS_OUT_CMD_EXE_ERR in the large recipe view.	-
290074	While saving, it was detected that a data record with the specified number already exists but under another name.	Overwrite the data record, change the data record number or cancel the action.
290075	A data record with this name already exists. The data record is not saved.	Please select a different data record name.
300000	Faulty configuration of process monitoring (e.g. using PDiag or S7-Graph): More alarms are queued than specified in the specifications of the CPU. No further ALARM_S alarms can be managed by the PLC and reported to the HMI devices.	Change the controller configuration.
300001	ALARM_S is not registered on this controller.	Select a controller that supports the ALARM_S service.
310000	An attempt is being made to print too many reports in parallel. Only one log file can be output to the printer at a given time; the print job is therefore rejected.	Wait until the previous active log was printed. Repeat the print job if necessary.
310001	An error occurred on triggering the printer. The report is either not printed or printed with errors.	Evaluate the additional system alarms related to this alarm. Repeat the print job if necessary.
320000	The movements have already been indicated by another device. The movements can no longer be controlled.	Deselect the movements on the other display units and select the motion control screen on the required display unit.
320001	The network is too complex. The faulty addresses cannot be indicated.	View the network in STL.
320002	No diagnostics alarm selected. The unit belonging to the alarm could not be selected.	Select a diagnostics alarm from the ZP_ALARM alarm screen.
320003	No alarms exists for the selected unit. The detail view cannot visualize any networks.	Select the defective unit from the overview screen.
320004	The required signal states could not be read by the PLC. The faulty addresses cannot be found.	Check the consistency between the configuration on the display unit and the PLC program.
320005	The project contains ProAgent elements which are not installed. ProAgent diagnostic functions cannot be performed.	In order to run the project, install the optional ProAgent package.
320006	You have attempted to execute a function which is not supported in the current constellation.	Check the type of the selected unit.
320007	No error-triggering addresses were found on the networks. ProAgent cannot indicate any faulty addresses.	Switch the detail screen to STL layout mode and check the status of the addresses and exclusion addresses.
320008	The diagnostic data stored in the configuration are not synchronized with those in the PLC. ProAgent can only indicate the diagnostic units.	Download the project to the HMI device again.

Number	Effect/cause	Remedy
320009	The diagnostic data stored in the configuration are not synchronized with those in the PLC. The diagnostic screens can be operated as usual. ProAgent may be unable to show all diagnostic texts.	Download the project to the HMI device again.
320010	The diagnostic data stored in the configuration are not synchronized with those in STEP7. The ProAgent diagnostics data is not up-to-date.	Download the project to the HMI device again.
320011	A unit with the corresponding DB number and FB number does not exist. The function cannot be executed.	Check the parameters of the "SelectUnit" function and the units selected in the project.
320012	The "Step sequence mode" dialog is no longer supported.	Use the ZP_STEP step sequence screen from the corresponding standard project for your project. Instead of calling the Overview_Step_Sequence_Mode function, call the "FixedScreenSelection" function using ZP_STEP as the screen name.
320014	The selected controller cannot be evaluated for ProAgent. The alarm view assigned to the "EvaluateAlarmDisplayFault" system function could not be found.	Check the parameters of the "EvaluateAlarmDisplayFault" system function.
330022	Too many dialogs open on the HMI device.	Close all dialogs you do not require on the HMI device.

Abbreviations

CPU	Central Processing Unit
CSV	Comma Separated Values
CTS	Clear To Send
DC	Direct Current
DCD	Data Carrier Detect
DIL	Dual-in-Line (electronic chip housing design)
DP	Distributed I/O
DSN	Data Source Name
DSR	Data Set Ready
DTR	Data Terminal Ready
EMC	Electromagnetic Compatibility
EN	European standard
ES	Engineering System
ESD	Electrostatic Discharge, the components and modules endangered by such
ESD	Electrostatic Sensitive Device
GND	Ground
HF	High Frequency
HMI	Human Machine Interface
IEC	International Electronic Commission
IF	Interface
LED	Light Emitting Diode
MMC	Multi-Media Card
MOS	Metal Oxide Semiconductor
MPI	Multipoint Interface (SIMATIC S7)
MS	Microsoft
MTBF	Mean Time Between Failures
n. c.	Not connected
OP	Operator Panel
PC	Personal Computer
PG	Programming device
PLC	Programmable Logic Controller
PPI	Point to Point Interface (SIMATIC S7)
RAM	Random Access Memory
RTS	Request To Send

RxD	Receive Data
SELV	Safety Extra Low Voltage
SP	Service pack
STN	Super Twisted Nematic
Sub-D	Subminiature D (plug)
TAB	Tabulator
TCP/IP	Transmission Control Protocol/Internet Protocol
TFT	Thin Film Transistor
TxD	Transmit Data
UL	Underwriter's Laboratory

Glossary

Acknowledge

Acknowledging an alarm confirms that you have noted it.

AG

Controller of the SIMATIC S5 series such as the AG S5-115U, for example

Alarm logging

Output of user-specific alarms to a printer, in parallel to their output to the HMI device screen.

Alarm, acknowledging

Acknowledgement of an alarm confirms that it has been noted.

Alarm, activated

Moment at which an alarm is triggered by the controller or HMI device.

Alarm, deactivated

Moment at which the initiation of an alarm is reset by the controller.

Alarm, user-specific

A user-specific alarm can be assigned to one of the following alarm classes:

- Error
- Warning
- User-specific alarm classes

A user-specific alarm designates a certain operating status of the plant connected to the HMI device via the controller.

AS

Controller of the SIMATIC S7 series such as a SIMATIC S7-300

AS 511

Protocol of the programming device interface of a SIMATIC S5 controller

Boot loader

Used to start the operating system. Automatically started when the HMI device is switched on. A start screen appears during startup. After the operating system has been loaded, the Loader opens.

Configuration computer

General term for programming devices (PGs) and PCs on which plant projects are created using an engineering software.

Control request

Triggers a function via the controller.

Controller

General term for devices and systems with which the HMI device communicates, e.g. SIMATIC S7.

Display duration

Defines whether and how long a system alarm is displayed on the HMI device.

EMC

Electromagnetic compatibility is the ability of electrical equipment to function properly in its electromagnetic environment without influencing this environment.

Engineering software

Software for the creation of projects for process visualization – see also project, process visualization and runtime software

Event

Functions are triggered by defined incoming events. Events can be configured. Events which can be assigned to a button include "Press" and "Release", for example.

Fault time

Refers to the time interval between an activated and deactivated alarm.

Field

Area reserved in configured screens for the input and output of values.

Flash memory

Non-volatile memory with EEPROM chips, used as mobile storage medium or as memory module installed permanently on the motherboard.

Half brightness lifetime

Time period until the brightness degrades to 50% of its original value. The specified value is dependent on the operating temperature.

Hardcopy

Output of the screen content to a printer.

HMI device image

File which can be transferred from the programming device to the HMI device. The HMI device image contains the operating system and elements of the runtime software required to run a project.

Infotext

Configured information on objects within a project. An alarm infotext, for example, may contain information on the cause of the fault and troubleshooting routines.

IO field

Enables the input or output of values on the HMI device which are transferred to the controller.

Notation

System consisting of characters, symbols and rules. In particular used to define the write format of a programming language in data processing.

Object

Component of a project. Example: screen or alarm. Objects are used to view or enter texts and values on the HMI device.

Operator control object

Component of a project which is used to enter values and trigger functions. A button, for example, is an operator control object.

Process visualization

Visualization of processes from the areas of production, logistics and services in text-based and graphics format. Configured plant screens allow operator intervention in active plant processes by means of the input and output data.

Project

Result of a configuration using an engineering software. The project normally contains several screens with embedded system-specific objects, basic settings and alarms. The project file of a project configured in WinCC flexible is saved under the file name extension *.hmi.

You distinguish between the project on the configuration computer and that on an HMI device. A project may be available in more languages on the configuration computer than can be managed on the HMI device. The project on the configuration computer can also be set up for different HMI devices. Only the project set up for a particular HMI device can be transferred to that HMI device.

Project file

File which is generated based on a source file for a specific HMI device when the configuration is completed. The project file is transferred to the corresponding HMI device and is used to operate and monitor plants. Refer to Source file.

Recipe

Combination of tags forming a fixed data structure. The data structure configured can be assigned data on the HMI device and is then referred to as a data record. The use of recipes ensures that when a data record is downloaded, all the assigned data is transferred synchronously to the controller.

Runtime software

Process visualization software which can be used to debug a project on a configuration computer. Also refer to "Project" and "Engineering software".

Screen

Form of the visualization of all logically related process data for a plant. The visualization of the process data can be supported by graphic objects.

Screen object

Configured object for operating and monitoring the system, e.g. a rectangle, an IO field or a recipe view.

Softkey

Key on the HMI device which supports user-specific functions. A function is assigned to the key in the configuration. The assignment of the keys may be specific to an active screen or not.

Source file

File from which various project files can be created, depending on the configuration. The source file is not transferred and remains on the configuration computer.

The file name extension of a source file is *.hmi. Refer to Source file, compressed and Project file.

Source file, compressed

Compressed form of the source file. Can be transferred in addition to the project file to the corresponding HMI device. "Enable Upload" must be set in the project on the configuration computer. The file extension of a compressed source file is *.pdz. The standard memory location for a compressed source file is the external MMC. Refer to Source file.

To restore a source file, it is necessary to use the same WinCC flexible version which was used to configure the project.

STEP 7

Programming software SIMATIC S7, SIMATIC C7 and SIMATIC WinAC controllers.

STEP 7 Micro/WIN

Programming software for controllers of the SIMATIC S7-200 series.

Symbolic IO field

Box for the input/output of a parameter. Contains a list of default entries from which one can be selected.

System alarms

Assigned to the "System" alarm class. A system alarm refers to internal states on the HMI device and the controller.

Tab order

In the configuration, this sets the sequence in which objects are focused on pressing the <TAB> key.

Tag

Defined memory location to which values can be written to and read from. This can be done from the controller or the HMI device. Based on whether the tag is interconnected with the controller or not, we distinguish between "external" tags (process tags) and "internal" tags.

Transfer

The transfer of an executable project to the HMI device.

"Transfer" mode

HMI device operating mode, set to transfer an executable project from the configuration computer to the HMI device.

Index

A

- Accessories, 13
- Accessory kit, 13
- Acknowledging
 - Alarm, 131, 134
 - Error alarm, 134
- Addressing
 - HMI device, 62
 - S7-200, 62
- Alarm, 14, 127
 - Acknowledging, 131, 134
 - Editing, 131, 135
 - Infotext for, 129
 - Viewing, 128
- Alarm buffer, 128
- Alarm class, 128, 133
 - Layout, 129
- Alarm event, 127
- Alarm indicator, 130, 134
- Alarm text
 - Long, 130
- Alarm text window, 130, 133
- Alarm view, 128, 132
- Alarm window, 128, 132
- Alphanumerical characters
 - Editing, 108
 - Entering, 107
- Alphanumerical screen keyboard, 120
- Alphanumerical value, 106
- Alphanumerical values, 118
 - Editing, 120
 - Entering, 107, 120
- Ambient temperatures
 - Impermissible, 33
- Approvals, 18, 22
- Area pointer
 - Configuring, 64

B

- Backing up, 95, 96, 98
 - Using ProSave, 98

- Using WinCC flexible, 96
- Backup, 92
- Bottom view, 13
- Bottom view of OP 73micro, 12

C

- Calibrating
 - Touch screen, 85
- Call sequence
 - Characters, 108
- Calling
 - Version information, 75
- Character input
 - Using control keys, 107, 110
- Characters
 - Call sequence, 108
 - Delete, 108
 - Inserting, 109
- Cleaning agents, 137
- Cleaning screen, 138
 - Locking an operator control object, 138
- Clearance, 32, 36
 - OP 73micro, 32
- Climatic
 - Storage conditions, 25
 - Transport conditions, 25
- Communication
 - Configuring the connection, 61
- Communication
 - Specifying the baud rate, 62
- Communication drivers
 - Installing S7-200, 60
- Communication partners
 - SIMATIC S7, 62
- Communications principle
 - S7-200, 63
- Conductor cross-section, 54
- Configuration instructions
 - Communication in the network, 60
 - PROFIBUS, 60
- Configuration phase, 89
- Configure
 - Operating system, 71

- Configuring
 - Operating system, 80
- Configuring communication
 - Software requirements, 60
- Configuring the data channel, OP 73micro, 79
- Connecting
 - Configuration computer, 53
 - Connection sequence, 40, 49
 - Equipotential bonding, 42, 51
 - HMI device, 40, 49
- Connecting the configuration computer
 - Wiring diagram, 44, 53
- Connecting the PLC
 - Wiring diagram, 44
- Connecting the PLC
 - Wiring diagram, 53
- Connecting the terminal block, 45, 54
- Connection sequence, 40, 49
- Connections
 - Number, 16
- Contrast, 74
 - Editing, 82
 - Setting, 74
- Control keys
 - For symbolic input, 107, 110
- Control Panel, 81
 - Opening, 81
 - Password protection, 80

D

- Data area date time
 - Structure, 65
- Data channel
 - Configuring TP 177micro, 88
 - Disable OP73micro, 79
 - Disable TP 177micro, 88
 - Enable OP73micro, 79
 - Enable TP 177micro, 88
- Data types, 63
- Date and time, 106, 118
 - Entering, 111, 122
- Date Time
 - Reading from the PLC, 64
- Decimal places, 106, 118
- Delay time
 - Editing, 82
 - Setting, 76
- Deleting
 - Password, 78
- Device Info, 74
- Dialog

- Bootloader, 46
- Dialog entries
 - Editing, 72
- Display, 143, 144
- Display format, 106

E

- EC declaration of conformity, 18
- Electrostatic charge, 150
- Enclosure, 144
- Entering
 - Alphanumerical characters, 107
 - Alphanumerical value, 106
 - Alphanumerical values, 107, 118, 120
 - Date and time, 106, 111, 118, 122
 - Numerical characters, 107
 - Numerical value, 106
 - Numerical values, 107, 117, 119
 - Symbolic value, 106
 - Symbolic values, 118, 122
- Equipotential bonding
 - Connecting, 42, 51
 - Installing, 43, 52
 - Requirements, 42, 51
 - Wiring diagram, 43, 52
- Equipotential bonding cable, 42, 51
- Error alarm
 - Acknowledging, 134
 - Acknowledgment by the PLC, 66
 - Acknowledgment on the HMI device, 67
 - Acknowledgment options, 66
- Explosion protection
 - Labels, 20

F

- Factory settings
 - Resetting to, 96
- Feedback
 - Optical, 115
- Field
 - Activate, 104
 - Navigating in the, 107
- Format patterns, 117
- Front view, 13
- Front view of OP 73micro, 12
- Function
 - Additional, 16
- Function test, 47, 56

H

- Help indicator, 112
- High frequency radiation, 17
- HMI device
 - Bottom view, 13
 - Connecting, 40, 49
 - EMC-compliant installation, 23
 - Fixation, 31
 - Front view, 13
 - Initial startup, 90
 - Interfaces, 50
 - Mounting, 34
 - Mounting position, 33, 48
 - Recommissioning, 90
 - Side view, 13
 - Switching off, 56
 - Switching on, 46, 55
 - Testing, 46, 55
- HMI device switching off, 47
- HMI device image
 - Querying the version, 84
- HMI device information
 - OP 73micro, 74
 - TP 177micro, 84
- Housing, 143

I

- IF 1B, 146, 147
 - OP 73micro, 146
 - TP 177micro, 147
- Info/Settings, 72
- Infotext, 15
 - Viewing, 112, 123, 129, 133
- Initial startup
 - HMI device, 90
- Input, 143, 144
 - Alphanumerical, 109
 - Example, 109
 - Numerical, 109
- Input on the HMI device
 - Using soft keys, 103
 - Using system keys, 104
- Instructions
 - General, 20
 - Security, 17, 20
 - Working on the cabinet, 17
- Interfaces, 41, 50
- Interference
 - Pulse-shaped, 23
 - Sinusoidal, 24

L

- Labeling
 - Approvals, 18
 - EC declaration of conformity, 18
- Labels
 - Explosion protection, 20
- Language
 - Setting, 105, 116
- LEDs, 69
- Limit value test, 106, 118
- Lists
 - Navigating in, 104
- Loader, 80
 - Navigating in the, 71
 - OP 73micro, 71
- Location of the manufacturer, 22
- Locking an operator control object, 138
- Logging off, 113, 124
- Logging on, 113, 124
- Logoff time, 113, 124
- Logon dialog, 113, 124

M

- Maintenance, 137, 139
- Manual transfer, 93
- Mechanical
 - Storage conditions, 25
 - Transport conditions, 25
- Memory, 143, 144
- Menu
 - Info/Settings, 72
 - Settings, 75
- Migration
 - Of OP3 projects, 91
 - Of TP 170A projects, 91
 - Of TP 170micro projects, 91
 - To OP 73micro, 91
 - To TP 177micro, 91
- Monitor settings
 - Editing, 82
- Mounting, 39
 - EMC-compliant, 23
 - HMI device, 34
 - Horizontal mounting, 34
 - Vertical mounting, 34
- Mounting clamp, 31, 34
- Mounting cut-out, 35
 - Dimensions, 31, 35
 - Preparing, 31, 35
- Mounting position, 30, 48
 - HMI device, 33

Mounting the HMI device
 Mounting position, 30
 Type of fixation, 31

N

Navigating
 In lists, 104
 In the field, 107
 in the Loader, 71
 Navigation
 in the Loader, 47
 Network connections, 58
 Nominal voltage, 38
 Numerical characters
 Editing, 108
 Entering, 107
 Numerical screen keyboard, 118
 Numerical value
 Decimal places, 106
 Display format, 106
 Limit value test, 106
 Numerical values
 Decimal places, 118
 Editing, 119
 Entering, 107, 117, 119
 Format patterns, 117
 Limit value test, 118

O

Offices, 6
 Offline, 90
 Offline test, 94
 Online, 90
 Online test, 94
 OP properties, 85, 87
 Operating mode
 Changing, 90
 Offline, 90
 Online, 90
 Overview, 90
 Transfer, 56, 91
 Operating system
 Configuring, 80
 Configuring OP 73micro, 71
 Updating, 100
 Operation feedback, 115
 Operation with key combinations, 103
 Operator control components, 69, 70
 Optical feedback, 115
 Overall dimensions, 142
 OP 73micro, 141

P

Password
 Deleting, 87
 Entering, 86
 Password, 77
 Assigning, 77
 Deleting, 78
 Editing, 77
 Password, 114
 Password
 Backing up/restoring, 114
 Password, 124
 Password
 Backing up/restoring, 124
 Password entry, 77
 Password list, 114, 124
 Password properties, 86
 Password protection, 73, 80
 PC-PPI adapter, 14
 Pin assignment
 Power supply, 146
 RS 485, 146
 PLC
 Connection, 57
 Connection of several HMI devices, 59
 Connection to the network, 58
 Number, 16
 Point-to-point connection, 57
 Polarity reversal protection, 46, 54
 Potential differences, 42, 50
 Potentially explosive atmosphere, 20
 Power supply, 143, 145
 Conductor cross-section, 45, 54
 Connecting, 46, 55
 Connecting the terminal block, 45, 54
 Polarity reversal protection, 46, 54
 Wiring diagram, 45, 54
 Process management phase, 89
 Project
 Closing, 114, 125
 Operating, 115
 Testing, 94
 Testing offline, 94
 Testing online, 94
 Transferring, 90
 Protective membrane, 14, 138
 Protocol parameters
 SIMATIC S7, 61
 Protocols
 Siemens PLC, 16

R

Radiation
 High frequency, 17
 Range of functions
 Alarms, 14
 Infotext, 15
 Screens, 15
 Tags, values, lists, 15
 Recommissioning
 HMI device, 90
 Registered trademarks, 6
 Representatives, 6
 Reset to factory setting, 92
 Reset to factory settings, 96
 Restore, 92
 Password list, 92
 Restoring, 95, 97, 99
 In the case of compatibility conflict, 95
 Using ProSave, 99
 Using WinCC flexible, 97
 RS 485, 147
 RS 485 (IF 1B), 146
 Ruler, 126

S

S7-200
 Active node, 58
 Passive node, 58
 PPI/master mode), 58
 PPI/slave mode), 58
 Safety instructions
 High frequency radiation, 17
 Potentially explosive atmosphere, 20
 Working on the cabinet, 17
 Scope of maintenance, 137
 Screen
 Changing the orientation, 82
 Screen keyboard, 117
 Alphanumerical, 120
 Keyboard layers, 120
 Numerical, 118
 Symbolic, 121
 Screen saver, 76
 Setting, 76, 87
 Screens, 15
 Security, 113, 124
 Security system, 113, 124
 Selecting
 In the field, 104
 Service
 On the Internet, 6

Service pack, 139
 Setting
 Contrast, 74
 Delay time, 76
 Screen saver, 76
 Settings, 75
 Side view, 13
 Side view of OP 73micro, 12
 Siemens PLC
 Protocols, 16
 SIMATIC S7
 Communication partners, 62
 Configuring protocol parameters, 61
 Network parameters, 62
 Soft keys, 69
 Global function assignment, 103
 Local function assignment, 103
 Specifications
 Display, 143, 144
 Enclosure, 144, 145
 Housing, 143
 Input, 143, 144
 Memory, 143, 144
 Overall dimensions, 142
 Overall dimensions OP 73micro, 141
 Power supply, 143, 145, 146
 RS 485, 146, 147
 Startup delay, 76
 Storage conditions, 25
 Support
 On the Internet, 6
 Switching off
 HMI device, 56
 Switching on
 HMI device, 55
 Symbolic screen keyboard, 121
 Symbolic value, 106
 Symbolic values, 118
 Editing, 122
 Entering, 111, 122
 System alarms
 Meaning, 152
 Parameters, 151
 System keys, 69, 104

T

Tag, 15
 Tags, 63
 Technical Support, 84
 Testing
 HMI device, 55
 Project, 94

Time, 106
 Entering, 122
Touch screen
 Calibrating, 85
 Note, 70
TP 070 projects, 91
Training center, 6
Transfer, 91, 92
 Cancel, 47, 56
 Manual, 93
 Requirements, 92
Transfer mode, 47
Transfer settings, 79, 88
Transferring
 Project, 90
Transport conditions, 25
Trend view, 125
 Value table, 126
Trends
 Limit violation, 125
Trends, 125
Type of fixation, 31, 34

U

Updating the operating system, 92
Upkeep, 137

Use

 Conditions, 27
 In industry, 20
 In residential areas, 20
 In the potentially explosive atmosphere, 20
 With additional measures, 27
User data
 Backing up/restoring, 114, 124
user data areas, 63
Users, 113, 124

V

Value table, 126
Version Info, 75
Version information
 Calling, 75

W

Wiring diagram
 Configuration computer, 53
 Connecting the equipotential bonding circuit, 43, 52
 Connecting the power supply, 54
Working on the cabinet, 17