

SIEMENS

SIMATIC

TD 200 Operator Interface

User Manual

This manual has the order number:
6ES7272-0AA00-8BA0

Preface, Contents

Product Overview and Installation

Configuring the TD 200

Operating the TD 200

Creating Sample Programs

Appendices

Specifications and Reference

Multiple CPU Configurations

Troubleshooting

TD 200 Parameters and
Messages

Index

1

2

3

4

A

B

C

D

Notes on Safety

This manual contains notices which you should observe to ensure your own personal safety, as well as to protect the product and connected equipment. These notices are highlighted in the manual by a warning triangle and are marked as follows according to the level of danger:



Danger

indicates that death, severe personal injury or substantial property damage **will** result if proper precautions are not taken.



Warning

indicates that death, severe personal injury or substantial property damage **can** result if proper precautions are not taken.



Caution

indicates that minor personal injury or property damage can result if proper precautions are not taken.

Note

draws your attention to particularly important information on the product, handling the product, or to a particular part of the documentation.

Qualified Personnel

Only **qualified personnel** should be allowed to install and work on this equipment. Qualified persons are defined as persons who are authorized to commission, to ground, and to tag circuits, equipment, and systems in accordance with established safety practices and standards.

Correct Usage

Note the following:



Warning

This device and its components may only be used for the applications described in the catalog or the technical description, and only in connection with devices or components from other manufacturers which have been approved or recommended by Siemens.

This product can only function correctly and safely if it is transported, stored, set up, and installed correctly, and operated and maintained as recommended.

Trademarks

SIMATIC®, SIMATIC NET® and SIMATIC HMI® are registered trademarks of SIEMENS AG.

Third parties using for their own purposes any other names in this document which refer to trademarks might infringe upon the rights of the trademark owners.

Copyright Siemens AG 1995 All rights reserved

The reproduction, transmission or use of this document or its contents is not permitted without express written authority. Offenders will be liable for damages. All rights, including rights created by patent grant or registration of a utility model or design, are reserved.

Siemens AG
Bereich Automatisierungs- und Antriebstechnik
Geschaeftsgebiet Industrie-Automatisierungssysteme
Postfach 4848, D- 90327 Nuernberg

Disclaimer of Liability

We have checked the contents of this manual for agreement with the hardware and software described. Since deviations cannot be precluded entirely, we cannot guarantee full agreement. However, the data in this manual are reviewed regularly and any necessary corrections included in subsequent editions. Suggestions for improvement are welcomed.

© Siemens AG 1995
Subject to technical change.

Preface

Purpose

The *SIMATIC TD 200 Operator Interface User Manual* is a combination user and reference manual that describes the operation of the TD 200 Operator Interface Module with an S7-200 programmable logic controller.

Audience

This manual is designed for engineers, programmers, and maintenance personnel who have a general knowledge of programmable logic controllers and operator interfaces.

Scope of This Manual

This manual describes the operation of version 1.1 and later of the TD 200. This release includes new features and other operational enhancements.

Release Notes

Version 1.1 of the TD 200 includes the following new features:

- Supports real (floating-point) numbers
- Provides password protection for editable variables and for the Menu mode of operation
- Supports multiple parameter blocks in a single S7-200 CPU (with a setup menu for entering the V memory address)
- Supports 19.2 Kbaud communication rate (with a setup menu for changing the baud rate)
- Sets a bit in the parameter block every time an arrow key is pressed, thus allowing your program to have more control of the TD 200
- Includes an alternative character set for creating bar charts

Other enhancements (such as using any key-not just the ESC key-to cancel the scrolling of the messages, or using SHIFT-ENTER to set a variable to 0) either improve the performance of the TD 200 or make it easier to use. For example, you can now use the SHIFT-UP/DOWN arrow keys to perform a character-by-character edit of a variable that is embedded in a message.

Version 1.2 of the TD 200 includes the following new features:

- Corrects problems with multi-master networks
- Makes the editors more consistent

For upgrades to version 1.2 of the TD 200, contact your distributor.

Agency Approvals

The SIMATIC S7-200 series meets the standards and regulations of the following agencies.

- Underwriters Laboratories, Inc.:
UL 508 Listed (Industrial Control Equipment)
- Canadian Standards Association: CSA C22.2 Number 142 Certified
(Process Control Equipment)
- European Community EMC Directive 89/336/EEC and
Low Voltage Directive 73/23/EEC

How to Use This Manual

If this is your first experience using an operator interface, read the entire manual. If you are an experienced user, refer to the Table of Contents or Index to find specific information.

Related Information

Refer to the following documentation for more detailed information about selected topics:

- *SIMATIC S7-200 Programmable Controller System Manual*: provides information about installing and programming the S7-200 Micro PLCs, including the following topics:
 - Installing and wiring the S7-200 CPU and expansion I/O modules, and installing the STEP 7-Micro/WIN software
 - Designing and entering a program
 - Understanding features of the CPU, such as data types and addressing modes, the CPU scan cycle, password-protection, and network communication

This manual also includes descriptions and examples for the programming instructions, typical execution times for the instructions, and the data sheets for the S7-200 equipment.

- *SIMATIC STEP 7-Micro/DOS User Manual*: describes how to use the STEP 7-Micro/DOS programming software package for the SIMATIC S7-200 series of programmable logic controllers.

SIMATIC Customer Support Hotline

Open round the clock, worldwide:



Nuremberg SIMATIC BASIC Hotline	Johnson City SIMATIC BASIC Hotline	Singapore SIMATIC BASIC Hotline
Local time: Mo.-Fr. 7:00 to 17:00 Phone: +49 (911) 895-7000 Fax: +49 (911) 895-7002 E-Mail: simatic.support@nbgm.siemens.de GMT: +1:00	Local time: Mo.-Fr. 8:00 to 17:00 Phone: +1 423 461-2522 Fax: +1 423 461-2231 E-Mail: simatic.hotline@sea.siemens.com GMT: -5:00	Local time: Mo.-Fr. 8:30 to 17:30 Phone: +65740-7000 Fax: +65740-7376 E-Mail: simatic.hotline@sae.siemens.com.sg GMT: +8:00
Nuremberg SIMATIC Authorization Hotline Local time: Mo.-Fr. 7:00 to 17:00 Phone: +49 (911) 895-7200 Fax: +49 (911) 895-7201 E-Mail: authorization@nbgm.siemens.de GMT: +1:00	SIMATIC Premium Hotline (fee based, only with SIMATIC Card) Local time: Mo.-Fr. 0:00 to 24:00 Phone: +49 (911) 895-7777 Fax: +49 (911) 895-7001 GMT: +01:00	
The languages of the SIMATIC Hotlines are generally German and English, in addition, French, Italian and Spanish are spoken on the authorization hotline.		

SIMATIC Customer Support Online Services

The SIMATIC Customer Support team offers you substantial additional information about SIMATIC products via its online services:

- General current information can be obtained from:
 - the **Internet** under <http://www.ad.siemens.de/simatic>
- Current product information leaflets and downloads which you may find useful are available:
 - the **Internet** under <http://www.ad.siemens.de/simatic-cs>
 - via the **Bulletin Board System** (BBS) in Nuremberg (*SIMATIC Customer Support Mailbox*) under the number +49 (911) 895-7100.

To access the mailbox, use a modem with up to V.34 (28.8 Kbps) with parameters set as follows: 8, N, 1, ANSI; or dial in via ISDN (x.75, 64 Kbps).

Contents

	Preface	iii
1	Product Overview and Installation	1-1
1.1	Hardware Features	1-2
1.2	Installing the TD 200	1-4
1.3	Connecting the Communication Cable	1-6
1.4	Connecting a Power Cable	1-7
1.5	Cleaning the Device	1-7
2	Configuring the TD 200	2-1
2.1	Starting the STEP 7-Micro/WIN TD 200 Configuration Wizard	2-2
2.2	Creating a Sample Program	2-20
3	Operating the TD 200	3-1
3.1	Using the Display Message Mode	3-2
3.2	Using the Menu Mode	3-5
3.3	Viewing Messages	3-6
3.4	Viewing CPU Status Menu	3-7
3.5	Forcing I/O	3-9
3.6	Setting Time and Date in the CPU	3-13
3.7	Releasing the Password	3-15
3.8	Using the TD 200 Setup Menu Option	3-16
4	Creating Sample Programs	4-1
4.1	Using a Text Message to Create a Clock for a CPU 214	4-2
4.2	Using the Bar Graph Character Set	4-5
A	Specifications and Reference	A-1
A.1	Certificates, Directives and Declarations	A-2
A.2	Approvals	A-3
A.3	Technical Specifications for Model Number 6ES7 272-0AA00-0YA0	A-4
A.4	ASCII Characters	A-7
A.5	ALT Key Combinations for International and Special Characters	A-8

B	Multiple CPU Configurations	B-1
B.1	Configuring for Multiple CPU Communication	B-2
B.2	Building a TD/CPU Cable	B-4
C	Troubleshooting	C-1
D	TD 200 Parameters and Messages	D-1
D.1	TD 200 Parameter Block	D-2
D.2	Building the Parameter Block	D-4
D.3	Formatting Messages	D-9
D.4	Embedding Data Values in a Text Message	D-11
D.5	Understanding Message Types	D-20
D.6	Editing Variables with the TD 200	D-22
	Index	Index-1

Product Overview and Installation

The Text Display 200 (TD 200) is a text display and operator interface for the S7-200 family of programmable logic controllers. This manual uses the terms programmable logic controller and S7-200 CPU (or CPU) interchangeably.

The following is a list of TD 200 features:

- Displays messages read from the S7-200 CPU.
- Allows adjustment of designated program variables.
- Provides ability to force/unforce I/O points.
- Provides ability to set the time and date for CPUs that have real-time clocks.

The TD 200 receives its power either from the S7-200 CPU through the TD/CPU cable or from a separate power supply.

The TD 200 functions as a point-to-point interface (PPI) master when it is connected to one or more S7-200 CPUs. The TD 200 is also designed to operate with any other PPI master in a network. Multiple TD 200s can be used with one or more S7-200 CPUs connected to the same network.

This manual provides you with hardware configuration directions and programming examples that require additional equipment. The following is a list of additional equipment that is necessary to set up and use your TD 200:

- S7-200 series programmable logic controller
- S7-200 programming device
- Programming cable appropriate for your programming device

Chapter Overview

Section	Description	Page
1.1	Hardware Features	1-2
1.2	Installing the TD 200	1-4
1.3	Connecting the Communication Cable	1-6
1.4	Connecting a Power Cable	1-7

1.1 Hardware Features

Components of the TD 200

The TD 200 is a small, compact device that provides all the necessary components for interfacing with your S7-200 CPU. Figure 1-1 shows the major components of the TD 200. These components are described in Table 1-1. For further information on the technical specifications of the TD 200, see Appendix A.

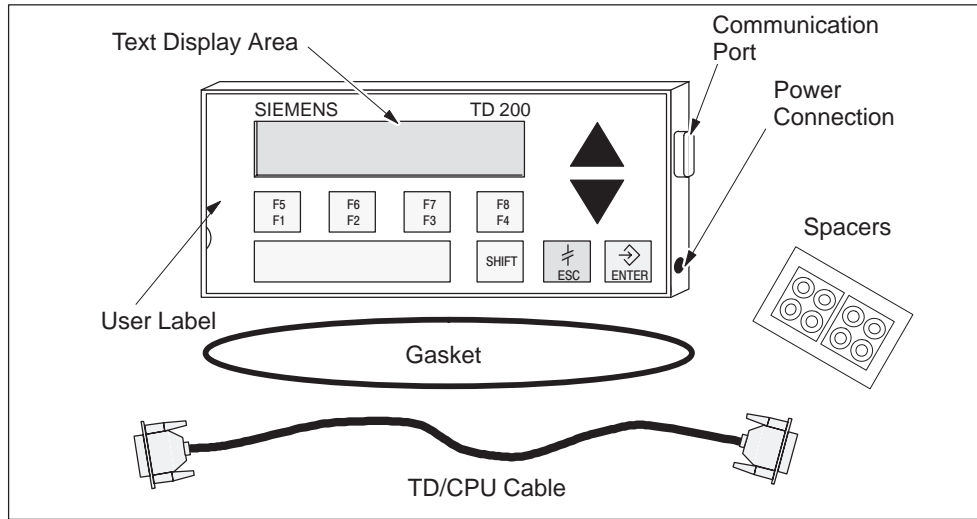

Figure 1-1 Major Components of the TD 200

Table 1-1 Components of the TD 200

Component	Description
Text Display Area	The text display area is a backlit liquid crystal display (LCD) with two 20-character lines. It allows you to see messages received from the S7-200 CPU.
Gasket	A gasket is provided with the TD 200 for installation in inclement environments.
Communication Port	The communication port is a 9-pin D-connector that allows you to connect the TD 200 to an S7-200 CPU using the supplied TD/CPU cable.
Power Connection	You can connect an external power supply to the TD 200 through the power connection access located on the right side of the TD 200. This connection is not required when you use the TD/CPU cable.
TD/CPU Cable	The TD/CPU cable provides communication and power to your TD 200. It is a 9-pin, straight-through cable that is supplied with your TD 200.
User Label	The user label is a pull-out label that you can use to customize the function key labels for your applications.

Table 1-1 Components of the TD 200

Component	Description
Keys	The TD 200 has nine keys. Five of these keys provide predefined, context-sensitive functions, and four keys provide user-defined functions.
Spacers	Self-adhesive spacers are included for mounting the TD 200 to a mounting surface. See Figure 1-4.

TD 200 Keyboard Features

The TD 200 keyboard has a total of nine keys. Table 1-2 describes the five predefined, context-sensitive command keys.

Table 1-2 Description of Command Keys

Command Keys	Description
ENTER	Use this key to write new data and to acknowledge a message(s).
ESC	Use this key to toggle between Display Message mode and Menu mode or to abort an edit.
UP ARROW	The UP arrow increments data and scrolls the cursor to the next higher priority message.
DOWN ARROW	The DOWN arrow decrements data and scrolls the cursor to the next lower priority message.
SHIFT	The SHIFT key modulates the value of all of the function keys. See Table 1-3 for examples. A flashing "S" is displayed in the lower right of the TD 200 display when you press the SHIFT key.

Table 1-3 describes the four user-defined function keys (F1, F2, F3, F4). You define these four function keys in your S7-200 CPU program. Pressing a function key sets an M bit. Your program can use this bit to trigger a specific action.

Table 1-3 Description of Function Keys

Function Keys	Description
F1	Function key F1 sets the Mx.0 bit. If you press the SHIFT key along with, or prior to, pressing the F1 key, F1 sets the Mx.4 bit.
F2	Function key F2 sets the Mx.1 bit. If you press the SHIFT key along with, or prior to, pressing the F2 key, F2 sets the Mx.5 bit.
F3	Function key F3 sets the Mx.2 bit. If you press the SHIFT key along with, or prior to, pressing the F3 key, F3 sets the Mx.6 bit.
F4	Function key F4 sets the Mx.3 bit. If you press the SHIFT key along with, or prior to, pressing the F4 key, F4 sets the Mx.7 bit.

1.2 Installing the TD 200

Preparing the Mounting Surface

Use the template in Figure 1-2 to cut a 138 mm x 68 mm or 5.4 in. x 2.7 in. hole in the mounting surface (DIN 43700).

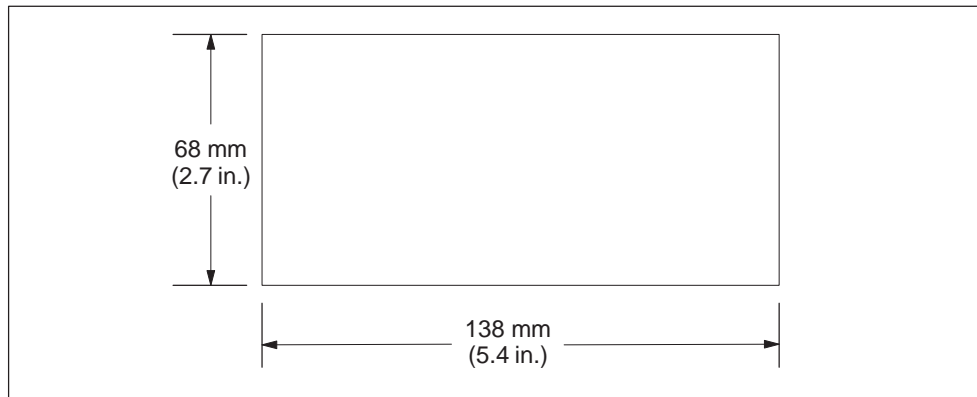

Figure 1-2 Mounting Surface Hole Dimensions

Preparing the TD 200 for Mounting

Use the following steps to prepare the TD 200 for mounting.

1. Remove the three screws from the rear of the TD 200 using a flat-head screwdriver. See Figure 1-3.
2. Remove the backplate of the TD 200.

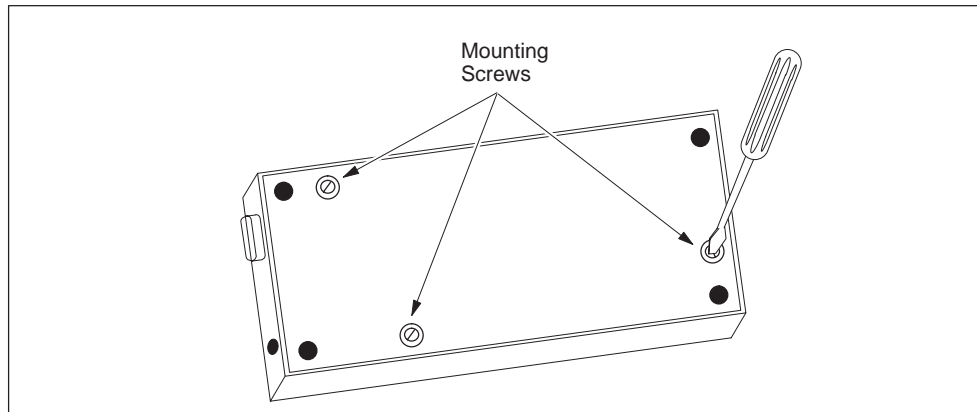

Figure 1-3 Removing the Three Mounting Screws

Self-adhesive spacers are included with the TD 200 for mounting the TD 200 to a mounting surface. The number of spacers you require depends on the thickness of the mounting surface. Use the following steps to install the spacers.

1. Use the following guidelines to determine the number of spacers required for proper mounting.
 - One spacer for door thickness from 0.3 mm to 1.5 mm (0.01 in. to 0.06 in.)
 - Two spacers on top of each other for door thickness of 1.5 mm to 4.0 mm (0.06 in. to 0.16 in.)
2. Place the spacers over the screw holes on the inside of the backplate. The spacers maintain pressure on the TD 200 circuit board when the TD 200 is reassembled. See Figure 1-4.

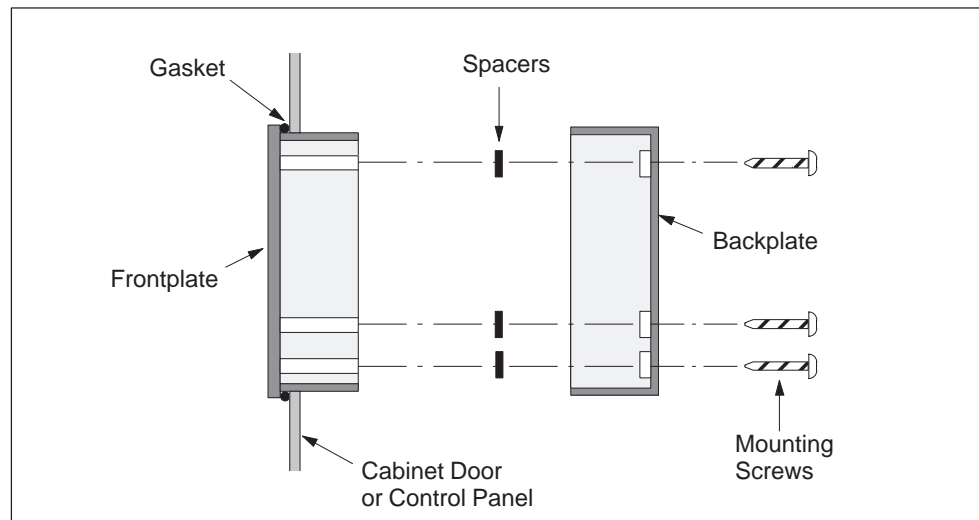

Figure 1-4 Positioning Spacers

Mounting the TD 200

Use the following steps and refer to Figure 1-4 to complete the mounting of your TD 200.

1. Place the supplied gasket on the frontplate of the TD 200.
2. Fit the frontplate into the cutout you made in the mounting surface.
3. Secure the backplate onto the frontplate of the TD 200 using the screws you removed from the backplate. Tighten the screws.

1.3 Connecting the Communication Cable

The TD 200 communicates to the S7-200 CPU through the TD/CPU cable. You can configure the TD 200 using the TD/CPU cable in the following ways:

- One-to-one configuration
- Multiple S7-200 CPU configuration

Installing Cable for One-to-One Communication

Use a one-to-one network configuration when you have just one S7-200 CPU to connect to one TD 200. A one-to-one configuration consists of a TD 200, an S7-200 CPU, and a TD/CPU cable that is supplied with the TD 200.

Figure 1-5 shows you a one-to-one configuration. The TD 200 communicates to and is powered by the S7-200 CPU using the TD/CPU cable.

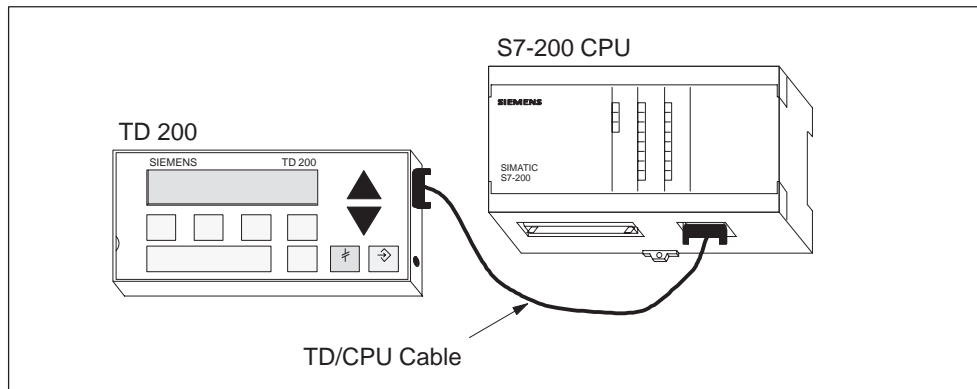

Figure 1-5 One-to-One Configuration

Installing a Multiple CPU Network

Use a multiple CPU network configuration when you have several S7-200 CPUs to connect to one or more TD 200s. For more information on configuring for multiple CPU communication, refer to Appendix B.

Note

The TD 200 defaults to address 1 and attempts to communicate to a CPU at address 2. See Section 3.8 to change the network address if other addresses are used.

1.4 Connecting a Power Cable

The TD 200 receives power either from the S7-200 CPU or from an external plug-in power supply unit.

Note

If you are using the TD 200 with a network of S7-200 CPUs, special consideration must be taken with the communication and power connections. See Appendix B.

Supplying Power from the S7-200 CPU

Figure 1-6 shows you the TD 200 receiving its power from the CPU through the TD/CPU cable. Use this type of power supply when the distance between the TD 200 and the S7-200 CPU is less than 2.5 m (8.2 ft.).

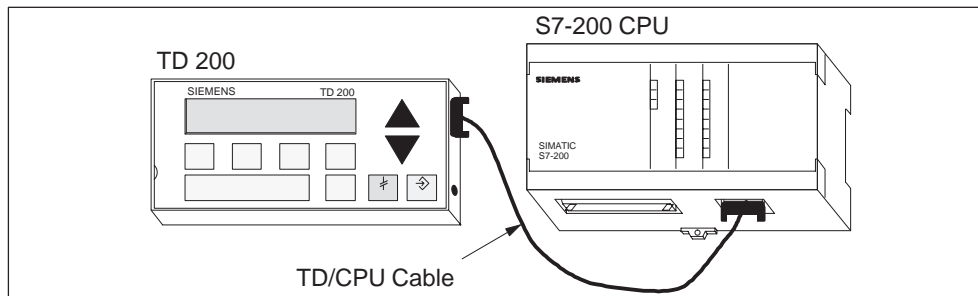

Figure 1-6 Supplying Power with the TD/CPU Cable

Supplying Power from an External Power Supply

Figure 1-7 shows the TD 200 receiving its power from an external power supply. Use this type of power supply when the distance between the TD 200 and the S7-200 CPU is greater than 2.5 m (8.2 ft.). If you choose to connect the TD 200 to the CPU with a longer cable (> 2.5 m/8.2 ft.), use PROFIBUS components (see the SINEC IK10 Catalog). The power supply is available from your Siemens distributor. See Appendix A for part numbers.

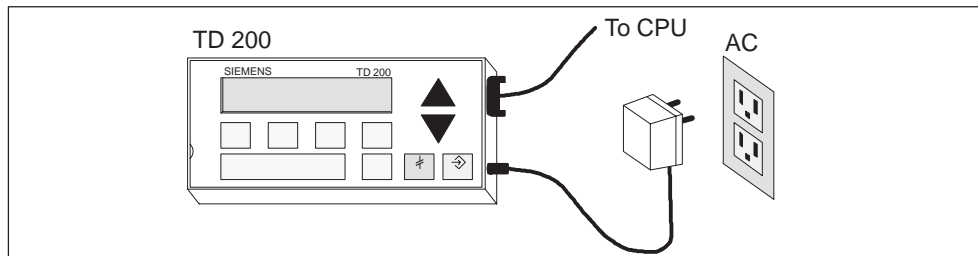

Figure 1-7 Supplying Power Using an External Power Supply

1.5 Cleaning the Device

To clean the programming device and display, use only a soft cotton cloth and a neutral cleaning agent.

Configuring the TD 200

The TD 200 is a text display device that displays messages enabled by the S7-200 CPU. You do not have to configure or program the TD 200. The only operating parameters stored in the TD 200 are the address of the TD 200, the address of the CPU, the baud rate, and the location of the parameter block. The configuration of the TD 200 is stored in a TD 200 parameter block located in the variable memory (V memory) of the CPU. The operating parameters of the TD 200, such as language, update rate, messages, and message-enabled bits, are stored in the TD 200 parameter block in the CPU.

Upon power-up, the TD 200 reads the parameter block from the CPU. All of the parameters are checked for legal values. If everything is acceptable, the TD 200 starts actively polling the message-enabled bits to determine what message to display, reads the message from the CPU, and then displays the message.

Chapter Overview

Section	Description	Page
2.1	Starting the STEP 7-Micro/WIN TD 200 Configuration Wizard	2-2
2.2	Creating a Sample Program	2-20

2.1 Starting the STEP 7-Micro/WIN TD 200 Configuration Wizard

STEP 7-Micro/WIN provides a “wizard” that makes it easy to configure the parameter block and the messages in the data memory area of the S7-200 CPU. The TD 200 Configuration Wizard automatically writes the parameter block and message texts to the data block editor after you finish choosing the options and creating the messages. This data block can then be downloaded to the CPU. For detailed information about the TD 200 parameter block and message formats, see Appendix D.

This chapter contains the procedure for creating a sample TD 200 application. Use the instructions in this example to create a TD 200 parameter block and three messages using the TD 200 Configuration Wizard. The first message is text only. The second message contains both text and embedded data. The third message is a text message that requires acknowledgement by the operator.

The example also shows how to use the function keys to enable a message and how to use the acknowledge- and edit-notification bits within your program.

To open the wizard, select the menu command **Tools > TD 200 Wizard...** as shown in Figure 2-1.

To navigate through the dialog boxes of the wizard, click on “**N**ext>.” At any time during the procedure, click on the “<**P**rev” button to go back to a previous dialog box if you need to change or review any of the parameters you have defined. In the final dialog box, click on “**F**inish” to validate and save the parameter block and close the wizard.

You can view the configured parameter block and messages by opening the STEP 7-Micro/WIN data block editor.

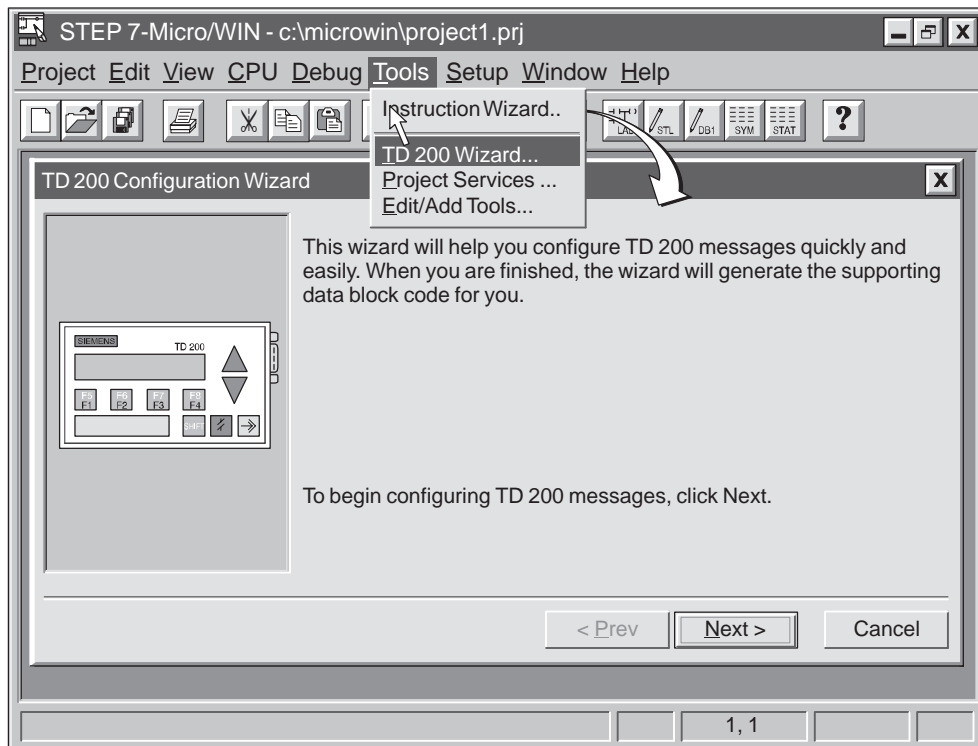

Figure 2-1 Accessing the TD 200 Configuration Wizard

Selecting Language and Bar Graph Character Set

The first dialog box in the TD 200 Configuration Wizard allows you to select the language and character set. Use the drop-down list box shown in Figure 2-2 to select the language in which the TD 200 menus display. (This selection does not affect the text of the user messages displayed on the TD 200.) Use the option buttons to select the standard character set or the alternate character set. The alternate character set allows you to display bar graph charts on the TD 200.

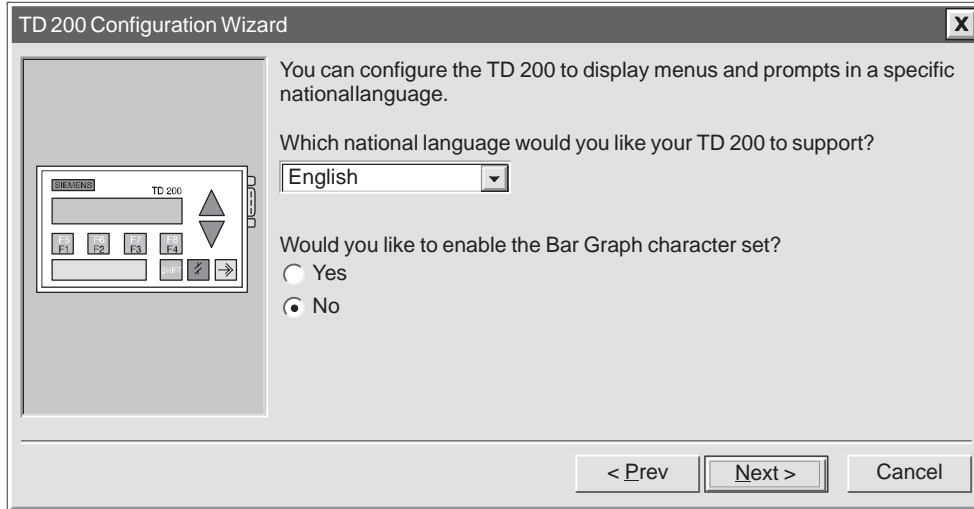

Figure 2-2 Wizard: Language and Character Set

Enabling Time-of-Day, Force Function, and Password Protection

The dialog box shown in Figure 2-3 allows you to enable Menu mode options and set an edit password.

The Time-of-Day (TOD) and force menu selections allow you to selectively enable the TOD Clock menu and/or the Force menu. Once a selection is enabled, you are allowed to access that menu in the TD 200. If the menu is not enabled, it does not appear in the TD 200 Menu mode.

The password protection selection allows you to enable a four-digit password (from 0000 to 9999). The password controls the ability of the operator to edit variables embedded in a message and to access the Menu mode. If you enable password protection, a field appears in the dialog box for you to set the password. This password is not the CPU password and it is stored in the TD 200 parameter block.

For this example, use the option buttons to select the modes shown in Figure 2-3. Set 1111 as your password.

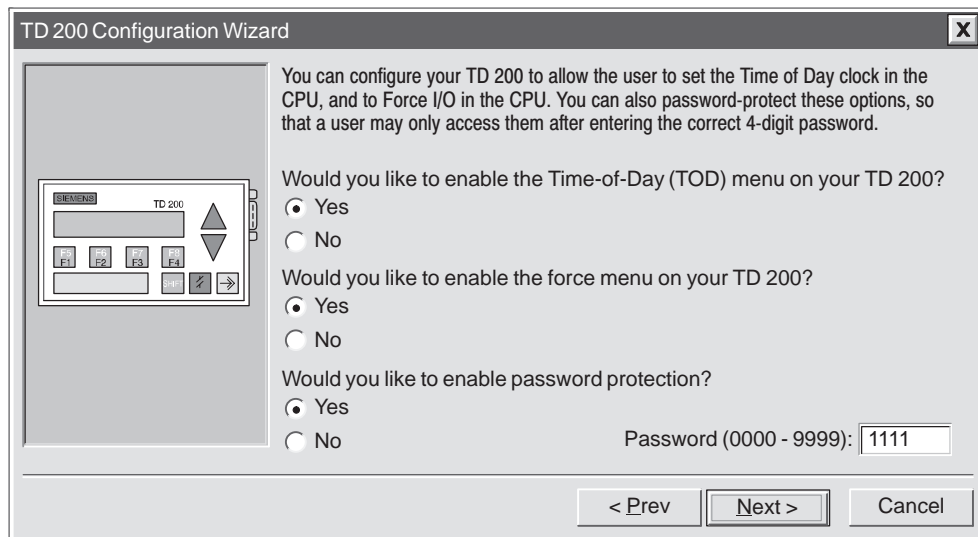

Figure 2-3 Wizard: Time-of-Day Clock, Force I/O, and Password Protection

Specifying Function Key Memory Bits and Display Update Rate

The dialog box shown in Figure 2-5 allows you to specify the marker byte (M memory) address for the TD 200 function keys and determine the update rate of the TD 200.

You must reserve eight bits of marker memory (M bits) for the TD 200 to use when a function key is pressed. Your program can inspect these bits and take an action when a key is pressed. One M bit is set by the TD 200 each time the corresponding function key is pressed. Always reserve an M Area address even when your program does not utilize function keys. Valid address values for specific CPUs are defined in the *SIMATIC S7-200 Programmable Controller System Manual*.



Warning

The TD 200 sets an M bit each time a function key is pressed. If you do not intend to use function keys, and so do not assign an M byte address for function keys, the TD 200 defaults to byte M0 for the function keys. If your program uses bits in M0, and a user presses any function key, the TD 200 sets the corresponding bit in M0, overwriting the value assigned to that bit by your program.

Inadvertent changes to M bits could cause your program to behave unexpectedly. Unpredictable controller operation could cause death or serious injury to personnel, and/or damage to equipment.

Always reserve an M area address, even when your program does not utilize function keys.

Figure 2-4 shows a referenced byte (MBn) and shows which bit of the byte is set by each function key.

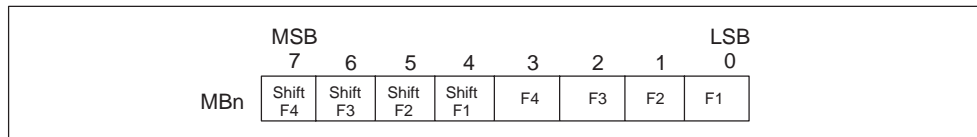

Figure 2-4 Bits Set by Each Function Key

The update rate selection determines how often the TD 200 polls the S7-200 CPU for messages to display. The actual update time may be slower than the time that you select because of the size of the message, the processing required, or network traffic.

For this example, select **M0** and **As fast as possible** as shown in Figure 2-5.

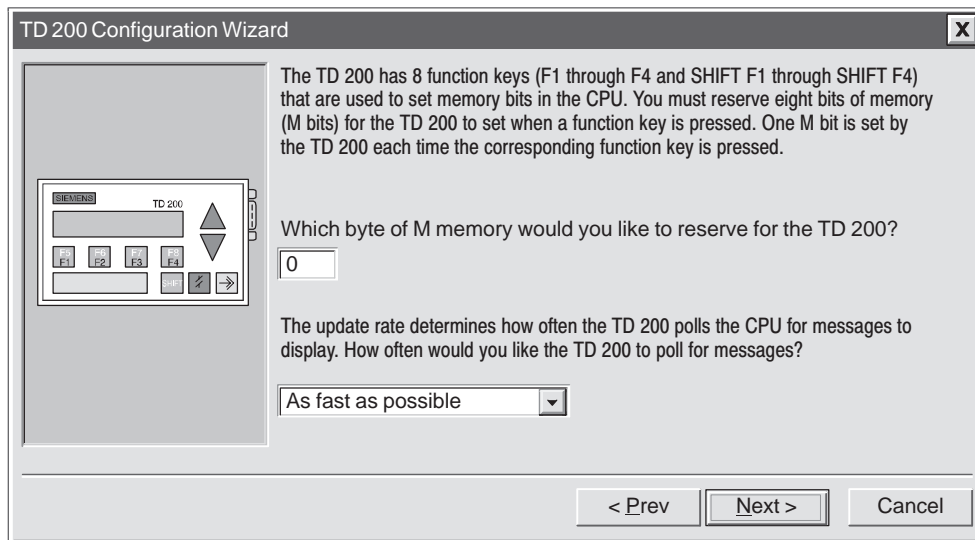

Figure 2-5 Wizard: Function Key Memory Bits and Update Rate

Selecting Message Size and Number of Messages

The dialog box shown in Figure 2-6 allows you to set the message size and quantity of messages. Select a 20- or 40-character size for your messages. The TD 200 supports up to 80 messages. Enter a number from 1 to 80 in the text field to specify the number of messages you want to create.

For this example, choose three 40-character messages.



Figure 2-6 Wizard: Message Size and Number of Messages

Specifying Parameter Block Address, Message Enable Address, and Message Location

The dialog box shown in Figure 2-7 allows you to specify starting addresses for the parameter block, the message enable flags, and the messages.

The TD 200 looks for a parameter block in the V memory of the CPU. The default location for the parameter block is VB0. The default location can be changed. See Section 3.8 and Section D.1 for information about placing the parameter block at other locations.

The starting byte for the message enable flags defines the location in V memory at which the message enable flags begin. There are eight message enable flags stored in each byte. Whole bytes must be allocated for message enable flags even if all the bits are not used. The text in the dialog box shown in Figure 2-7 specifies how many bytes of V memory are needed for message enable flags based on the number of messages you set in the previous (Figure 2-6) dialog box.

The starting byte for message information defines the starting location of the first message in V memory. Messages are placed consecutively in memory. Either 20 or 40 bytes are reserved for each message based on your selection in the previous dialog box (Figure 2-6). The text in the dialog box shown in Figure 2-7 specifies how many bytes are required for messages.

Values for the parameter block, enable flags, and message information starting addresses are CPU specific. See the *SIMATIC S7-200 Programmable Controller System Manual* for the valid address ranges for specific CPUs.

For this example, set the parameter block starting byte to 0, the enable flags address to 12, and the message information starting address to 40 as shown in Figure 2-7.

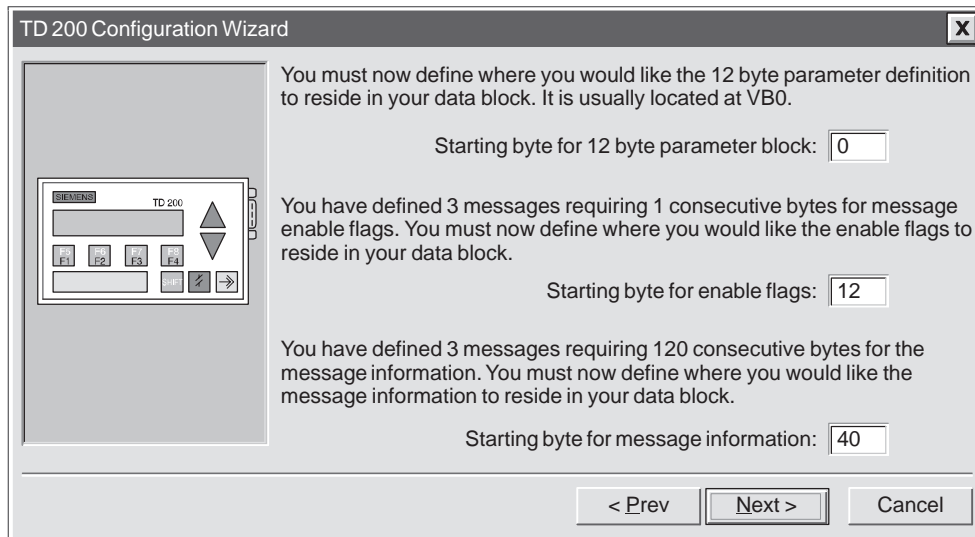

Figure 2-7 Wizard: Block Address, Enable Flags, and Message Location

Creating A Text-Only Message

The dialog box in Figure 2-8 allows you to enter the text for a TD 200 message. The dialog box also shows you the starting address of the message (Message beginning address). It also shows you the address of the message-enabled bit for this message. Your program uses this message-enabled bit to control the display of this message on the TD 200. Setting the message-enabled bit to a 1 causes the TD 200 to read and display this message.

For this example, type in your message as shown in Figure 2-8. This is a text-only message, so there is no embedded data. Since there are two more messages to configure in this example, click on “Next Message >” to continue.

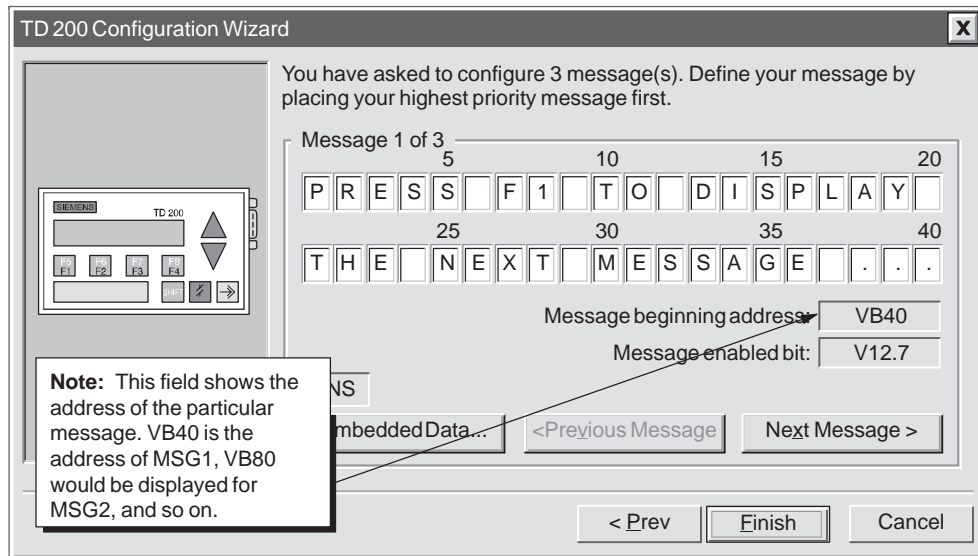

Figure 2-8 Wizard: 40-Character Message

Embedding Data Values in a Text Message

You can place a data value within the message that displays on the TD 200. In order to display a data value, you must reserve space in the message for the data value and for format information. The format information tells the TD 200 how to display and edit the data value. The format information requires the space of two characters in your message. Word data values require the space of two characters in addition to the format information (four characters total). Double word or real (floating point) values require the space of four characters in addition to the format information (six characters total).

When you insert a data value into a message, you must be sure there are enough characters to contain the format information and the embedded data value on the current line of the display. For example, if you insert a word value, (two characters for the word value and two characters for the format information), you must allow at least four spaces between the starting position of the embedded data value and the end of the current message line.

The right-most character of an embedded data value serves as the anchor point for that value in the TD 200 display. Data values are always right justified to that anchor point within messages on the TD 200 display. As a data value grows in magnitude, it utilizes more spaces to the left of the anchor point and can begin to use the spaces occupied by the message text. Be sure to leave sufficient space between the end of your text and the anchor point to allow for the expected range of the data value.

The number of display characters used to display a value varies with the size of the value. This number of characters required to display a number is not the same as the number of characters used to store the embedded data value in the message. The number of display characters required depends on the range of values for that number in a specific application. See Table D-1 for examples of the number of display characters required for different display formats.

The TD 200 displays all values as decimal numbers. Positive signed values are displayed without a sign. Negative signed values are displayed with a leading minus sign. Unsigned values are displayed without a sign. A leading zero is used for all fractional numbers (for example, 0.5). Real numbers are displayed with the number of decimal places you specify. The value is rounded to the specified decimal place.

For this example, type in the text shown in Figure 2-9. This example message has two embedded data values, one in the top line and one in the second line. The data value in the top line is an integer. The data value in the second line is a real number.

A word value requires two characters for the value plus two more characters for format information. Place the cursor at the character position shown in Figure 2-9 (four spaces from the right). Click on the “Embedded Data...” button to bring up the Embedded Data dialog box.

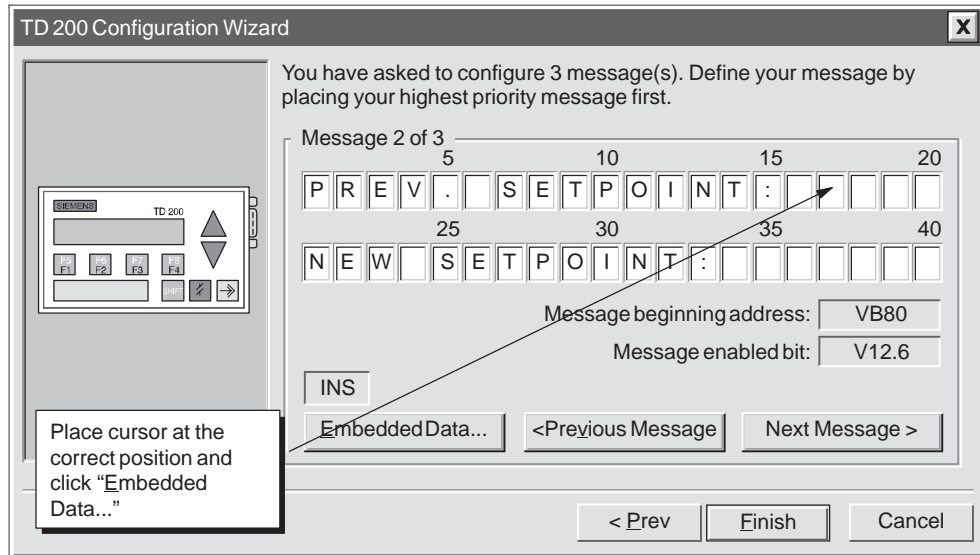

Figure 2-9 Wizard: Embedding Variable Data Value in a Message

Formatting the Embedded Data Value

Figure 2-10 shows the Embedded Data dialog box. This dialog box allows you to specify the data type, format, and display characteristics of an embedded data value. You can also select whether or not the message requires acknowledgement, whether the data value can be edited, and whether or not editing requires a password. Some options depend on the selections you make and do not appear when the dialog box opens.

The data format selection defines the size of the data value embedded in the message:

- Select “None” when a message requires acknowledgement but there is no embedded data value to be displayed on the TD 200.
- Select “Word” when the embedded data value is an integer. A word or integer value requires the space of two characters within your message to hold the data value.
- Select “Double Word” when the embedded data value is a double word or a real (floating point) value. A double word or real value requires the space of four characters within your message to hold the data value.

The display format selection tells the TD 200 whether the data value is signed or unsigned. The TD 200 uses this information when editing the data value. Signed values may be either positive or negative numbers. Unsigned values are restricted to positive numbers.

The selection for digits to the right of the decimal provides scaling for the display of the data value. If the data value is an integer, this selection allows you to scale the integer value for display by specifying the location of the decimal point. For example, if the data value is equal to 123 and you select 1 digit to the right of the decimal, the TD 200 displays 12.3.

The Embedded Data dialog box contains a check box to require acknowledgement of the message. If a message requires acknowledgement, it flashes on the TD 200 display until the operator presses ENTER. The dialog box also contains a check box for allowing editing of the data value. If this box is selected, the operator can edit the embedded data value. If the box is not checked, the data cannot be edited.

The Embedded Data dialog box also lists the address of the data value within the message. The user program uses this address to write the data value in the message.

For this example, make the selections shown in Figure 2-10 and click “OK.”

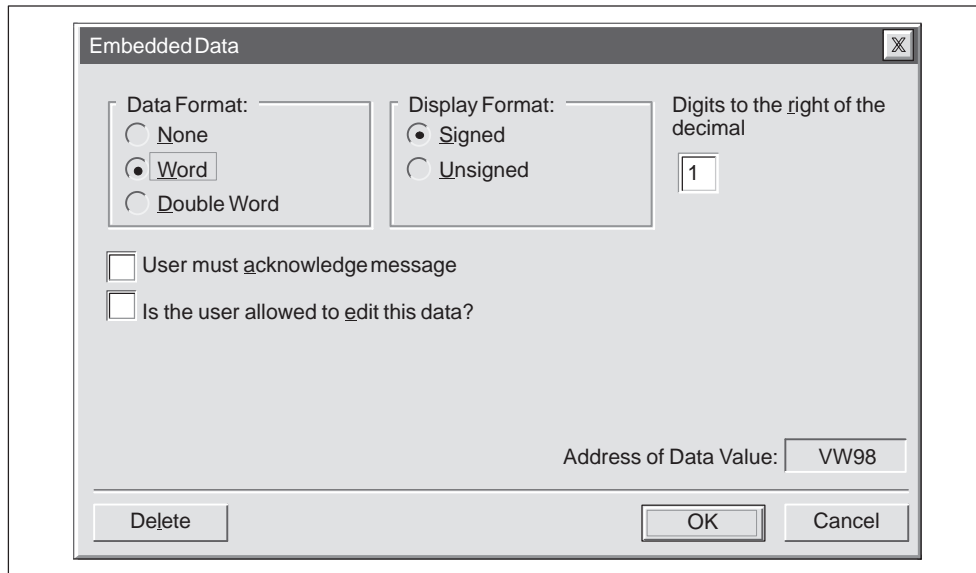

Figure 2-10 TD 200 Message: Creating a Word Embedded Data

Figure 2-11 shows the message dialog box after you have formatted the first embedded data value. The grayed fields show the characters used by the format information (always two) and the data value (two for word values).

The second data value in the message is a real number. Real numbers require four characters plus two characters for format information. Move the cursor to position 35 and click on “Embedded Data...” to enter the format information for the second data value.

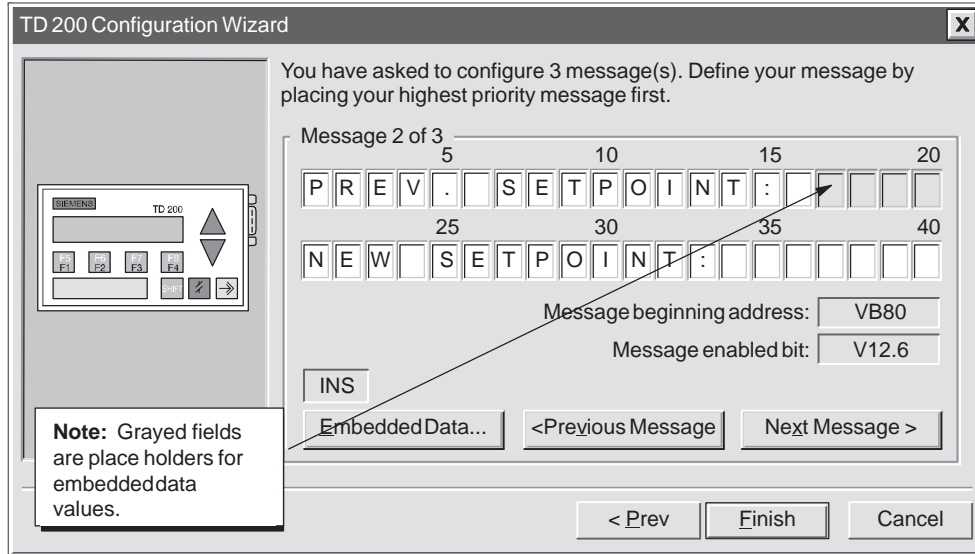

Figure 2-11 Wizard: Embedded Data Value Place Holder in Message

This variable displays as a real number which requires a double word data format. After you select “Double Word,” the Display Format area allows selection of a real (floating point) number format. For real numbers, the field entitled Digits to the right of the decimal defines the fixed decimal location of the real number in the TD 200 display. The TD 200 rounds a real number to the specified decimal place. For example, if the real number value is 123.456 and you select 2 digits to the right of the decimal, the TD 200 displays this value as 123.46.

In this example, this variable should be editable by the user. Select the check box that allows the user to edit the data. Once the edit-allowed selection has been made, two new fields appear in the Embedded Data dialog box.

The Edit Notification Bit field specifies the location of a bit which the TD 200 sets to 1 whenever the data value is edited and written to the CPU. The CPU program uses the edit-notification bit to recognize when an editable data value has been changed. The program can then read and make use of the edited value. The user program is responsible for resetting this bit to 0.

The password-protected check box asks you if you wish to require a password for editing this data value. If checked, the operator must enter a password before being allowed to edit the data value. You selected the password at the beginning of the configuration process (see Figure 2-3); it is shown in the Password for Edit field.

After you have made the selections shown in Figure 2-12, click “OK” to continue the configuration for this example.

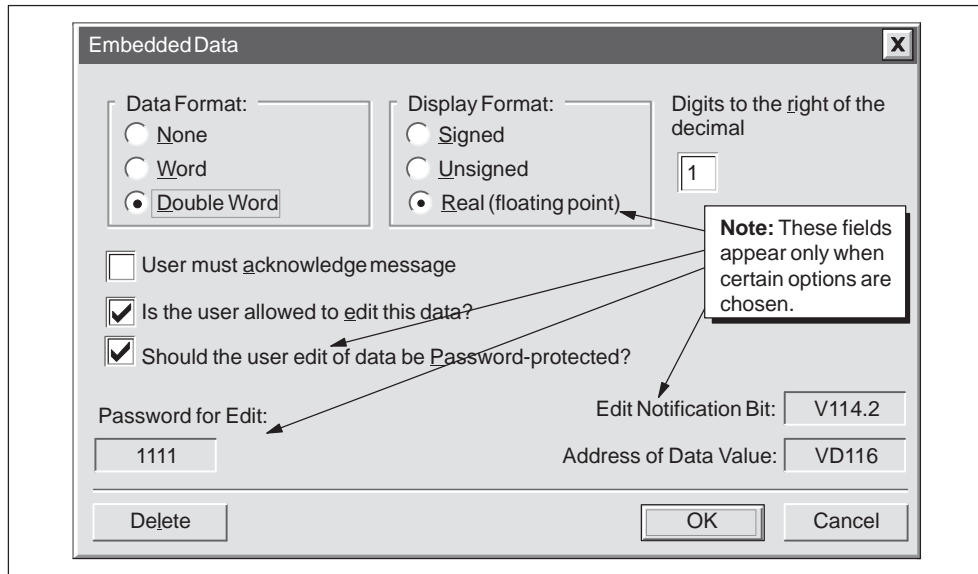

Figure 2-12 Embedded Data: Making the Data Editable and Password Protected.

Figure 2-13 shows the message dialog box after you have completed your selections for both embedded data values in this message. Click “Next Message >” to continue the example.

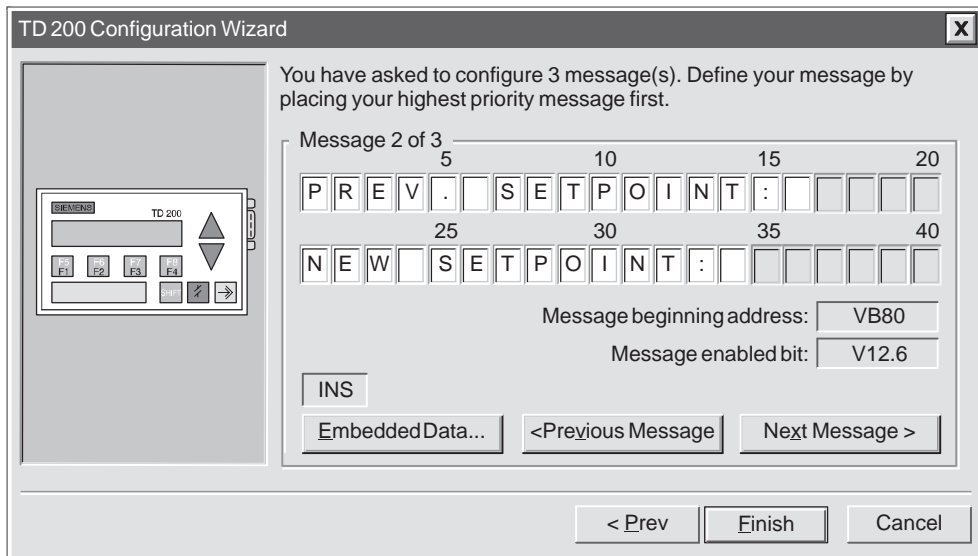

Figure 2-13 Wizard: Completed Second Message

Creating a Message That Requires Acknowledgement

To ensure that important messages are displayed and acknowledged by an operator, you can configure a message to require acknowledgement. This message flashes when displayed on the TD 200. The operator must press the ENTER key on the TD 200 to acknowledge the message.

When the message is acknowledged, the following things happen:

- The message stops flashing.
- The acknowledge-notification bit is set in the CPU.
- The message-enabled bit for this message is reset in the CPU.

To force acknowledgement of a message, embed a format word in the message. The format word tells the TD 200 how to display the message. The format word uses two contiguous characters within your message. Since there is no data associated with this format word, the format word can be placed anywhere in your message (not just at the end). The format characters appear as blank spaces on the TD 200 display.

For this example, enter the message text as shown in Figure 2-14. Place the cursor on the 39th digit position and click on “Embedded Data...” button below.

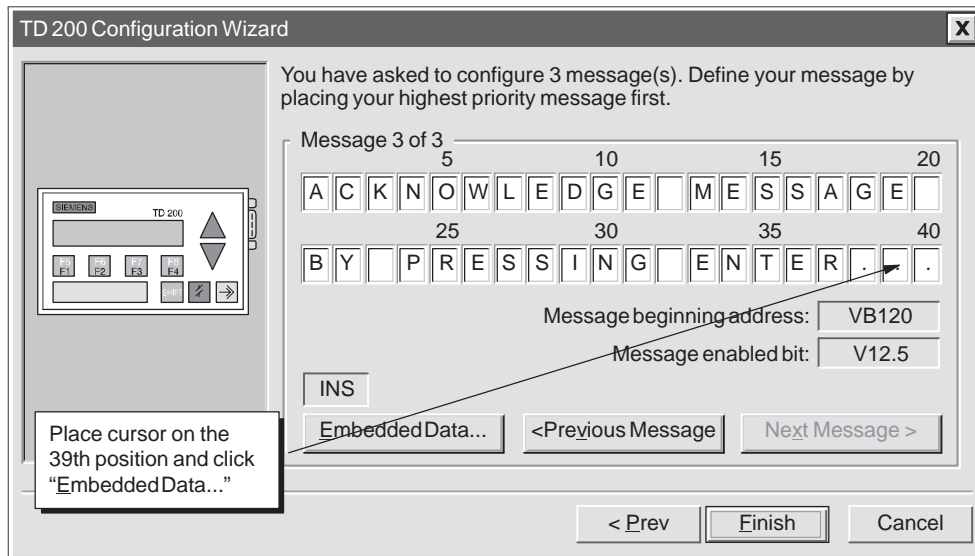

Figure 2-14 Wizard: Embedding Data to Require Acknowledgement

The Embedded Data dialog box is shown in Figure 2-15. For this message, select a data format of “None” since there is no data to be displayed. To force acknowledgement of the message, select the “User must acknowledge message” check box.

Note

If you have more than one embedded data value in a message, you only need to select the acknowledgement check box for the first embedded data value in the message. The TD 200 ignores the acknowledge bit in all subsequent data values of the message.

For this example, make the selections shown in Figure 2-15 and click on the “OK” button to return to the message configuration dialog box.

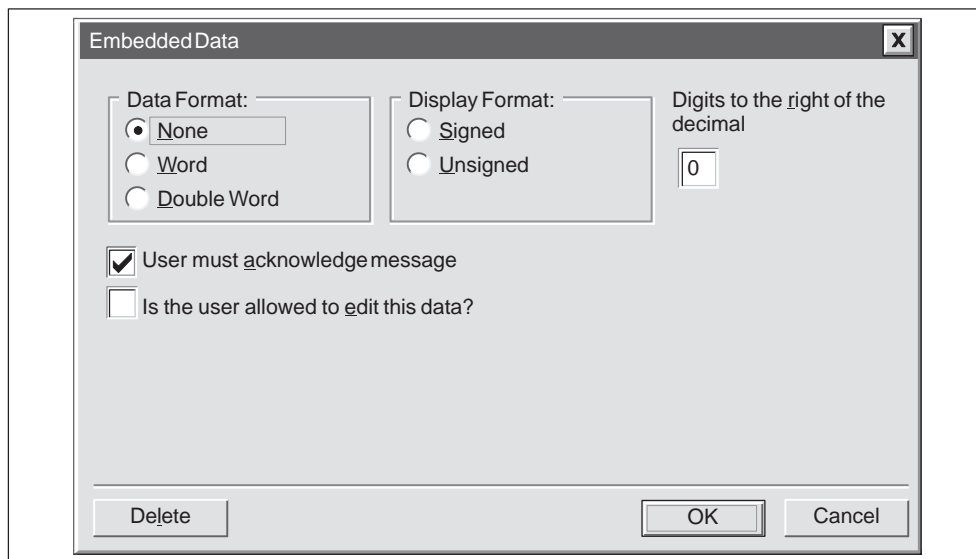

Figure 2-15 Embedded Data: Requiring Acknowledgement of Message

Now that you have set the format to require acknowledgement of the message, the Acknowledgement notification bit field displays the address location of the acknowledge-notification bit, as shown in Figure 2-16. This location can be used in the user program to take an action when the user acknowledges the message on the TD 200. The TD 200 sets this bit to 1 when the message is acknowledged. The user program is responsible for resetting the acknowledge-notification bit to 0 if it is used within the program.

Click the “Finish” button to exit the TD 200 Configuration Wizard.

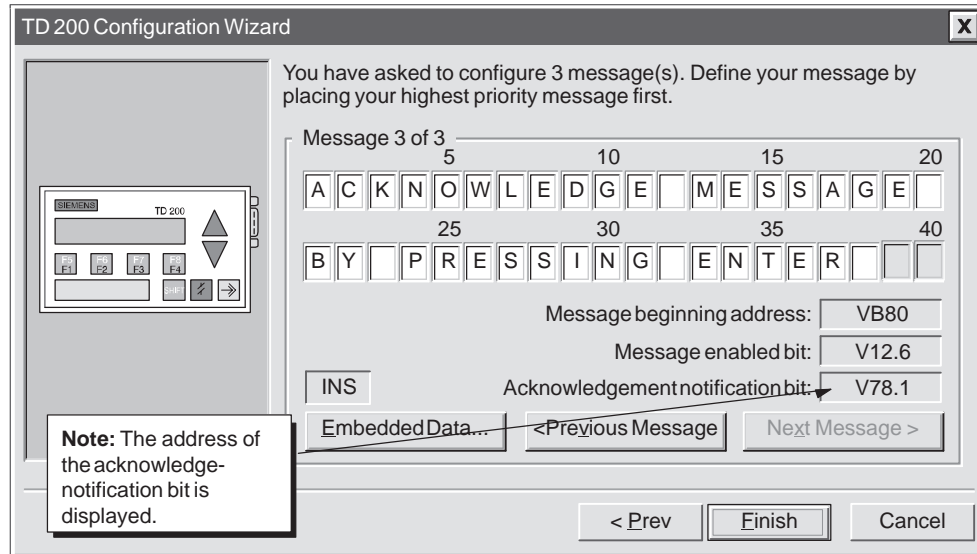
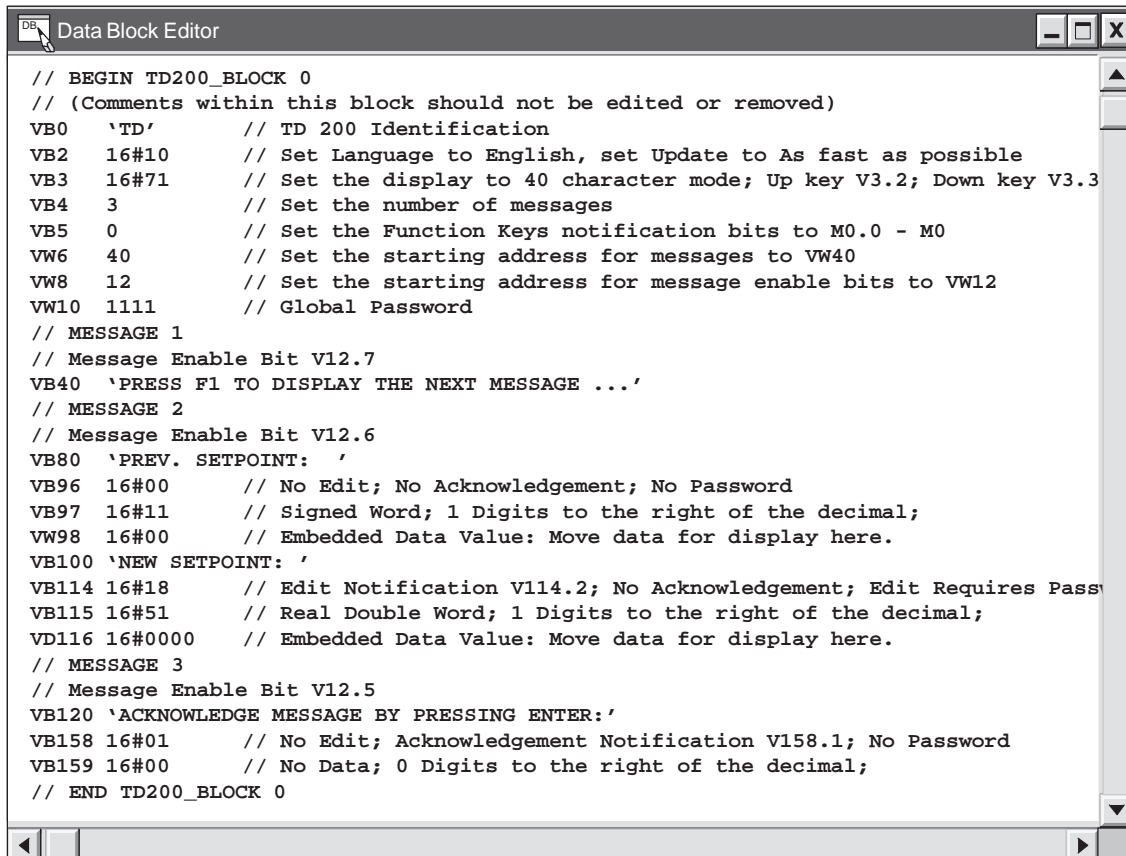

Figure 2-16 Wizard: Message Requires Acknowledgement

Viewing the TD 200 Parameter Block and Messages

The TD 200 Configuration Wizard creates a data block containing the TD 200 parameter block and messages. You can open the data block editor to view the TD 200 parameter block and messages that were formatted by the wizard.

Figure 2-17 shows the data block for the example in this chapter.



```

Data Block Editor
// BEGIN TD200_BLOCK 0
// (Comments within this block should not be edited or removed)
VB0  'TD'      // TD 200 Identification
VB2  16#10     // Set Language to English, set Update to As fast as possible
VB3  16#71     // Set the display to 40 character mode; Up key V3.2; Down key V3.3
VB4  3         // Set the number of messages
VB5  0         // Set the Function Keys notification bits to M0.0 - M0
VW6  40        // Set the starting address for messages to VW40
VW8  12        // Set the starting address for message enable bits to VW12
VW10 1111     // Global Password
// MESSAGE 1
// Message Enable Bit V12.7
VB40 'PRESS F1 TO DISPLAY THE NEXT MESSAGE ...'
// MESSAGE 2
// Message Enable Bit V12.6
VB80 'PREV. SETPOINT: '
VB96 16#00     // No Edit; No Acknowledgement; No Password
VB97 16#11     // Signed Word; 1 Digits to the right of the decimal;
VW98 16#00     // Embedded Data Value: Move data for display here.
VB100 'NEW SETPOINT: '
VB114 16#18    // Edit Notification V114.2; No Acknowledgement; Edit Requires Passw
VB115 16#51    // Real Double Word; 1 Digits to the right of the decimal;
VD116 16#0000 // Embedded Data Value: Move data for display here.
// MESSAGE 3
// Message Enable Bit V12.5
VB120 'ACKNOWLEDGE MESSAGE BY PRESSING ENTER:'
VB158 16#01    // No Edit; Acknowledgement Notification V158.1; No Password
VB159 16#00    // No Data; 0 Digits to the right of the decimal;
// END TD200_BLOCK 0

```

Figure 2-17 Data Block Editor Showing a Sample TD 200 Parameter Block

2.2 Creating a Sample Program

Click on the Ladder Editor to create and view your program in Ladder Logic. Click on the Statement List Editor to create and view your program in Statement List format. Figure 2-18 shows a sample program in both the Ladder and Statement List editors. This program uses the TD 200 configuration information from the example created in this chapter.

Download the program and data block to a CPU. Attach a TD 200 to the CPU to see the messages created with the wizard. Use the following keys on the TD 200:

- Press F1 to go to the setpoint message.
- Press ENTER to edit the setpoint. Press ENTER again to go to the acknowledge message.
- Press ENTER to acknowledge the third message.
- Press F2 to enable all three messages at once.
- Press F3 to disable all the messages.

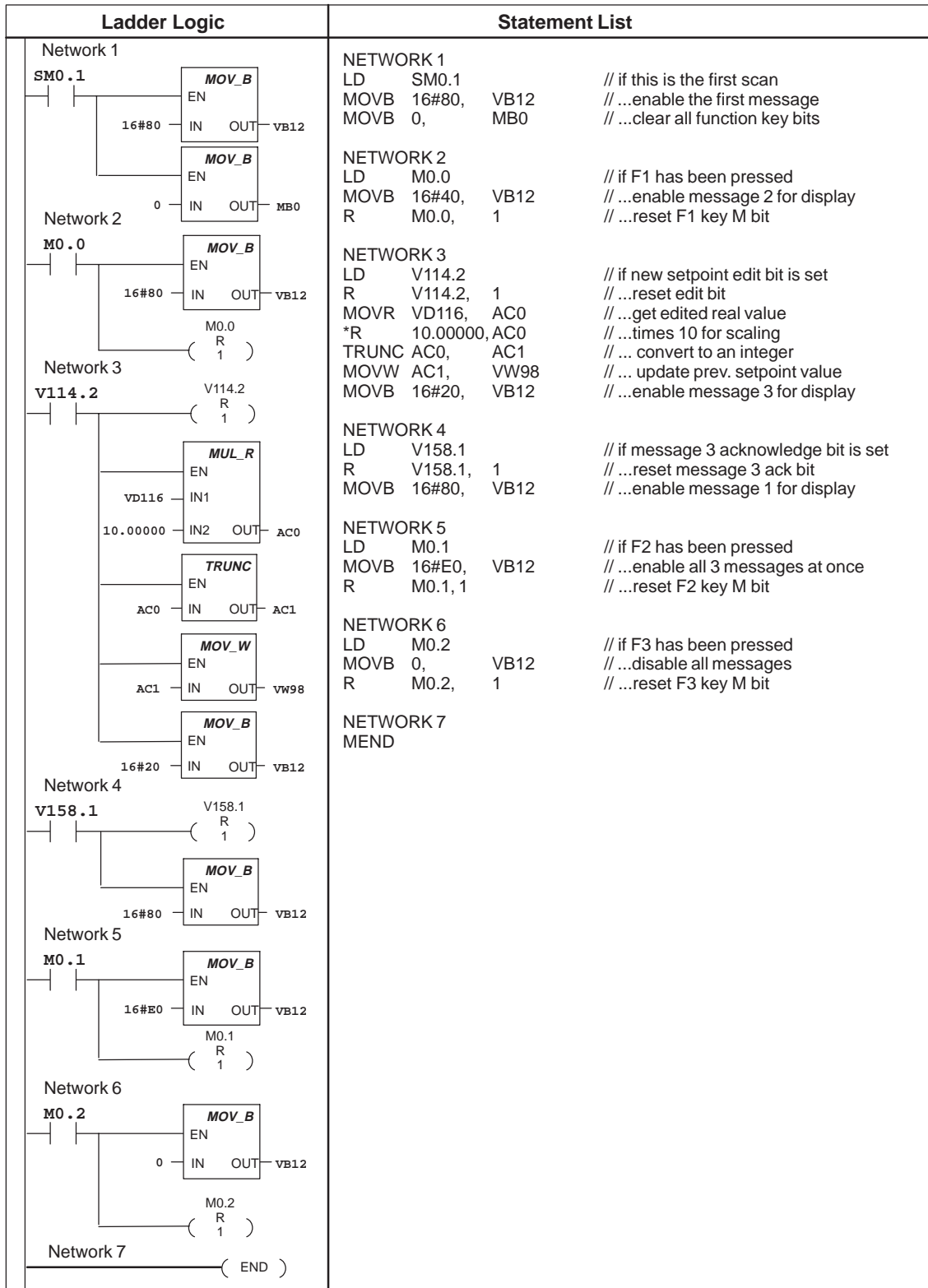

Figure 2-18 Sample Program in the Ladder and Statement List Editors

Operating the TD 200

This chapter describes the two operating modes of the TD 200:

- Display Message mode: This is the default operating mode of the TD 200. This chapter contains a description of the functions available.
- Menu mode: You can access up to six different TD 200 menu options. This chapter contains a description of each menu and its function, steps to access each menu and a description of how you can use it.

Chapter Overview

Section	Description	Page
3.1	Using the Display Message Mode	3-2
3.2	Using the Menu Mode	3-5
3.3	Viewing Messages	3-6
3.4	Viewing CPU Status Menu	3-7
3.5	Forcing I/O	3-9
3.6	Setting Time and Date in the CPU	3-13
3.7	Releasing the Password	3-15
3.8	Using the TD 200 Setup Menu Option	3-16

3.1 Using the Display Message Mode

The Display Message mode is the default operating mode of the TD 200. When you power up the TD 200, the TD 200 enters the Display Message mode and remains in this mode until you enter the Menu mode. The TD 200 returns to the Display Message mode from the Menu mode if you do not press any keys for one minute.

Figure 3-1 shows you the default message of the Display Message mode.

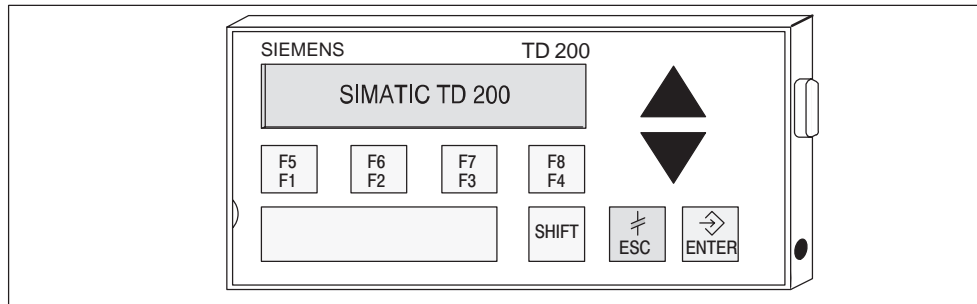

Figure 3-1 Display Message Mode

Functions Available

In the Display Message mode, you can perform the following functions:

- Scroll through enabled messages
- Edit values
- Acknowledge a message

There is no cursor on the display in the Display Message mode. The cursor is only displayed when a key is pressed. To show the cursor, you must press either the UP or the DOWN key.

Scrolling through Messages

If there are more messages enabled than the display can show, the TD 200 displays the one or two (based on message size) highest priority messages and places a flashing DOWN arrow at the right-most character of the second line. This indicates that there are more messages available for display. Use the following steps to view additional messages:

1. Press the DOWN arrow. The TD 200 displays the next lower priority message(s).
2. Press the UP arrow. The TD 200 displays the next higher priority message(s).
3. Press any key (except the UP or DOWN arrows). The TD 200 exits the scrolling mode.

Editing a Value

You can use the TD 200 to modify variables embedded in the messages. The operator uses the arrow keys and the ENTER key to select a message and to edit variables.

Use the following procedure to edit a variable:

1. Select a message by pressing either the UP or the DOWN arrow key to place the cursor on the first character of the desired message.
2. Press ENTER to move the cursor to the least significant (right-most) character of the first editable variable in the message.
3. If the variable is password-protected, enter the 4-digit password at the prompt and press ENTER.
4. Press either the UP or the DOWN arrow key to increment or decrement the variable. (Pressing and holding either the UP or the DOWN key accelerates the increment or decrement operation.)
 - To move the cursor to the next digit position, press either the SHIFT UP (left) or the SHIFT DOWN (right) keys.
 - To reset the variable to 0, press the SHIFT ENTER keys.
5. Press ENTER to write the updated variable to the CPU.

At the same time the updated value is written to the CPU, the corresponding edit-notification bit is set to 1.

If you do not edit the message variable, or abort the edit by pressing ESC, the message-enable bit is not cleared by the TD 200. The message-enable bit is cleared by the TD 200 only when you write the last editable variable to the CPU.

The UP and DOWN arrows that indicate higher and lower priority messages, if any are present, are disabled while an edit is in progress. These functions are restored when the edit is completed or aborted.

If there are more editable variables in the message, the cursor moves to the next variable. After all of the variables in the message have been edited, the message-enable bit for the message is cleared in the CPU. The message is then removed from the display on the next update cycle.

Note

Due to restrictions in the format used to store real (floating-point) numbers in both the S7-200 CPU and the TD 200, the accuracy of the number is limited to six significant digits. Editing a real number with more than six digits may not change the value of the variable, or may cause other digits within the number to change:

- Changing the least significant (right-most) digit of a real-number variable with more than six digits may have no effect. For example: if you try to change the "9" in "1234.56789", the value of the variable does not change.
 - Changing the most significant (left-most) digit of a real-number variable with more than six digits may cause other (less significant) digits in the variable to change.
-

You can abort an edit at any time by pressing ESC. This causes the TD 200 to reread the message from the CPU and to display the variables from the CPU. When the edit session is aborted, any values that have already been sent to the CPU (by pressing the ENTER key after modifying the value) are displayed; any value that was modified but not saved is overwritten by the previous (original) value.

When you abort an edit, the cursor returns to the left-most character of the message. (The message is not removed from the display until all of the edits are completed and written to the CPU.) If the message was configured for acknowledgement, the message starts to flash again, since the edit was not completed.

Note

An edit is automatically aborted if you do not press a key after one minute.

Acknowledging a Message

Some messages require acknowledgement. To acknowledge a message, move the cursor to the first character of the message and press ENTER. Messages requiring acknowledgement are not replaced on the display until you acknowledge the message.

Messages that do not require acknowledgement or editing are replaced on the display if a higher priority message is enabled by the S7-200 CPU. For more information on acknowledging a message, see Section D.5.

3.2 Using the Menu Mode

The Menu mode of the TD 200 allows you to view all messages, display the S7-200 CPU status information, view and set the time and date in CPUs with real-time clocks, force I/O, release the password, and modify the configuration of the TD 200.

The TD 200 enters the Menu mode when you press ESC and the cursor is at the left-most character of a line. The TD 200 immediately displays the first menu item as shown in Figure 3-2 (providing that password protection is not enabled). If the password protection option is enabled, the TD 200 displays a prompt for entering the password (a four-digit integer from 0000 to 9999). Enter the correct password to view the first menu item as shown in Figure 3-2.

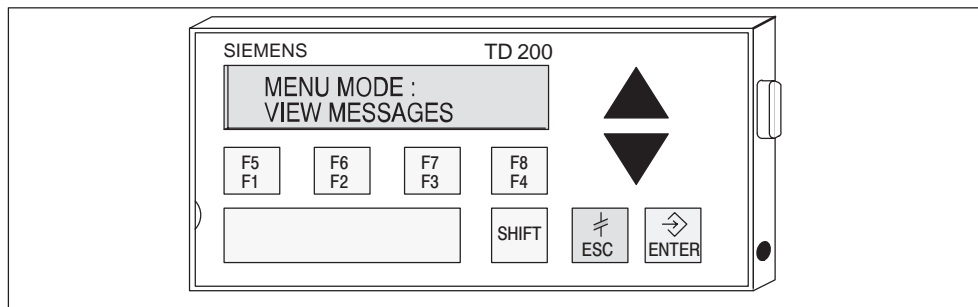

Figure 3-2 Menu Mode

Menus Available

The menu items available in the Menu mode are:

- View Messages
- View CPU Status
- Force I/O (if allowed in parameter block)
- Set Time and Date (if allowed in parameter block)
- Release Password (if enabled)
- TD 200 Setup

Selecting Menu Options

To select a menu item, you scroll through the list of available items by pressing the UP and DOWN arrows. When the desired menu item is displayed, press ENTER.

Exiting Menu Mode

The TD 200 exits the Menu mode when you press ESC during the display of one of the menu items. Also, the TD 200 exits the Menu mode automatically after one minute and returns to the Display Message mode if you have not pressed any keys.

3.3 Viewing Messages

With the View Messages menu, you can sequentially view all of the messages and process values stored in the S7-200 CPU. Press the UP and DOWN arrows to display the second (and subsequent) message from the programmable logic controller.

Note

You cannot edit process values while you are in the View Messages menu option.

Accessing the Menu

To access the View Messages menu, perform the following steps.

	Key	Action	Display
1.	ESC	The TD 200 enters the Menu mode.	MENU MODE : VIEW MESSAGES
2.	ENTER	The TD 200 enters the View Messages menu.	YOUR MESSAGE

Use the UP and DOWN arrows to scroll through messages stored in the S7-200 CPU. You cannot edit values in this mode. You can only edit values in the display mode.

Note

Pressing ESC at any time when you are viewing messages aborts the message display and returns you to the Display Message mode. The TD 200 automatically returns to the Display mode after one minute if no keys are pressed.







3.4 Viewing CPU Status Menu

With the View CPU Status menu, you can verify the S7-200 CPU RUN/STOP status and check the CPU for fatal and non-fatal errors. The TD 200 displays the CPU mode first and then displays the fatal and non-fatal errors sequentially.

The TD 200 displays an error message only if an error exists in the S7-200 CPU. The CPU classifies errors as either fatal errors or non-fatal errors. Refer to the *SIMATIC S7-200 Programmable Controller System Manual* for more information about specific errors.

Accessing the Menu

To access the View CPU Status menu, perform the following steps.



	Key	Action	Display
1.		The TD 200 enters the Menu mode.	
2.		The TD 200 scrolls down the menu options one time.	
3.		The TD 200 enters the View Status menu.	

Note

Pressing ESC at any time when you are verifying the S7-200 CPU status returns you to the Display Message mode. The TD 200 automatically returns to the Display mode after one minute if no keys are pressed.

Viewing Fatal and Non-fatal Errors

If fatal and/or non-fatal errors are present, use the following process to view the fatal and non-fatal errors.

	Key	Action	Display
		The TD 200 scrolls down the list of errors that are present.	

Fatal Error Messages

The following is a list of possible fatal error messages, in order of importance:

- FATAL WATCHDOG TIMEOUT
- FATAL CHECKSUM ERROR
- FATAL EEPROM FAILURE
- FATAL MC FAILURE [MC is memory cartridge]
- FATAL RUNTIME ADDR ERROR

Non-fatal Error Messages

The following is a list of possible non-fatal error messages, in order of importance:

- NON-FATAL DIVIDE BY ZERO
- NON-FATAL QUEUE OVERFLOW
- NON-FATAL I/O ERROR MOD x [x = module number]

The NON-FATAL I/O ERROR MOD x failure message displays the number of the I/O module that has failed. In the case of multiple failures, this message is displayed multiple times, one time for each failed module. The module numbering is zero to six, corresponding to the CPU specification for expansion modules. Failures in the I/O of the CPU are displayed as module C.

- NON-FATAL RUNTIME PROG ERR

The non-fatal run-time program error includes:

- Indirect addressing
- HSC setup and execution errors
- Attempting to execute an illegal instruction (ENI, DISI, or HDEF) inside an interrupt routine
- Subroutine nesting errors
- TODW data errors
- Simultaneous XMT and RCV errors

3.5 Forcing I/O

The Force I/O menu is only available if the force-menu enable is set in the TD 200 configuration that is stored in the CPU. The Force I/O menu allows you to force inputs, force outputs, or unforce all inputs and outputs.





In the S7-200 CPU, you can establish password protection for the force I/O function. The TD 200 reads the password protection level from the CPU. If the force function is password protected, the TD 200 asks you to enter the CPU password.

Note

The CPU password restricts editing of the force information in the S7-200 CPU. This password is different from the password protection offered by the TD 200, which restricts the editing of variables that are embedded in a message.

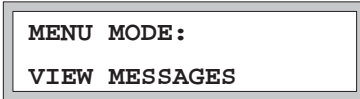
Accessing the Menu

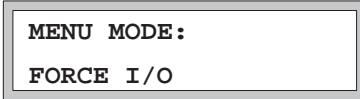
To access the Force I/O menu, perform the following steps.





	Key	Action	Display
1.		The TD 200 enters the Menu mode.	
2.	 	The TD 200 scrolls down the menu options two times.	
3.		The TD 200 enters the Force I/O menu. If a force function is password protected, the TD 200 displays the following.	

Note

Pressing ESC at any time while you are forcing I/O returns you to the Display Message mode. The TD 200 automatically returns to the Display Message mode after one minute if no keys are pressed.

Entering a Password

To enter a password, perform the following steps.

	Key	Action	Display
1.	 	The TD 200 scrolls through the possible characters for the password.	
2.	ENTER	Press ENTER when the correct character is found for the current password character location. The cursor then moves to the next character location.	

Repeat this process for all eight password characters. For passwords with fewer than eight characters, use blank spaces (the default character) by pressing ENTER for the unused (remaining) characters. After the eighth character is entered, the TD 200 attempts to legitimize the communication link to the CPU. If the password is incorrect, the TD 200 displays the message shown in Figure 3-3.

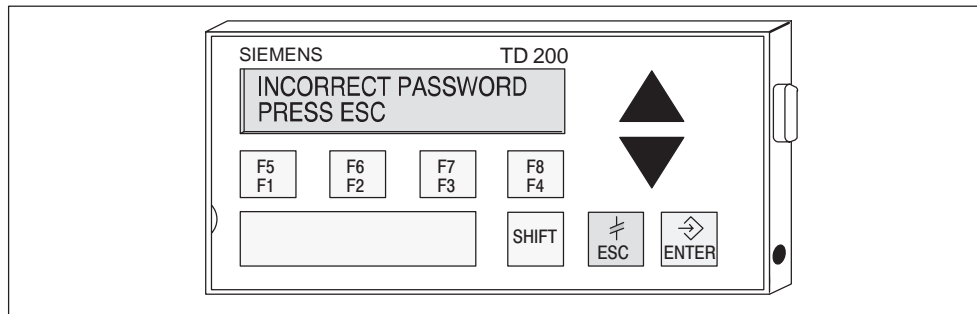

Figure 3-3 Incorrect Password Display

Correcting a Password

Press ESC and repeat the steps for entering a password.

Selecting a Force I/O Option

When you enter the correct password, you are allowed into the Force I/O menu. The Force I/O menu allows you to force inputs, force outputs, or unforce all inputs and outputs.

To select a Force I/O option, follow these steps.

1. Scroll through the following options by pressing the UP or DOWN arrow.

FORCE INPUTS?

FORCE OUTPUTS?

UNFORCE ALL I/O?

2. Press ENTER when the desired option is displayed on the second line of the display.

Figure 3-4 shows you one of the Force I/O options that you can select.

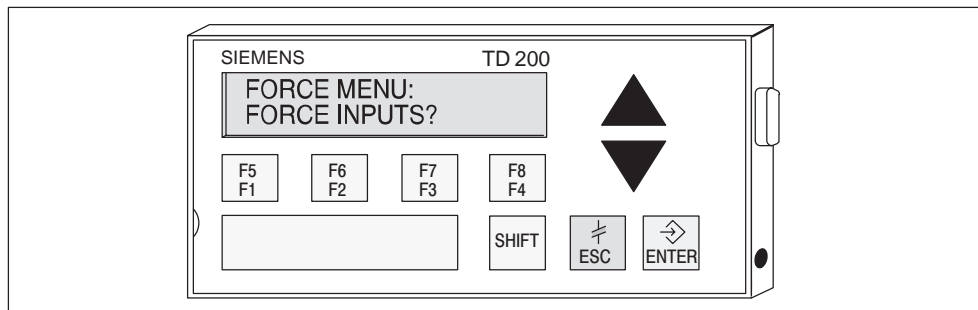

Figure 3-4 Force I/O Menu Display

Note

Unforcing the I/O points does not place them in the OFF state. Unforcing only removes force. The points remain in their last state until you manually change them or they are changed by the program.



Caution

A fatal error can occur in the S7-200 CPU if power is removed before the force information is written to the EEPROM of the CPU.

Such a failure could result in the CPU going into fatal error mode upon next power-up.

To clear the fatal error, rewrite the force information to the CPU or unforce all I/O points, then power cycle the CPU to clear the fatal error.

Forcing and Unforcing an I/O Point

If you select the force outputs option, the display appears as shown in Figure 3-5. The cursor appears on the right-most character of the I/O address.

To change the force status of an I/O point, perform the following steps.

1. Press either the UP or DOWN arrow to change the I/O address to the desired value. The second line of the display shows the force status of the current address.
2. When you reach the desired address, press ENTER to move the cursor to the second line.
3. Press either the UP or DOWN arrow to change the force status to one of the following choices:

NOT FORCED

FORCED ON

FORCED OFF

4. When you reach the desired status, press ENTER to write that status to the S7-200 CPU. The cursor moves back to the I/O address.

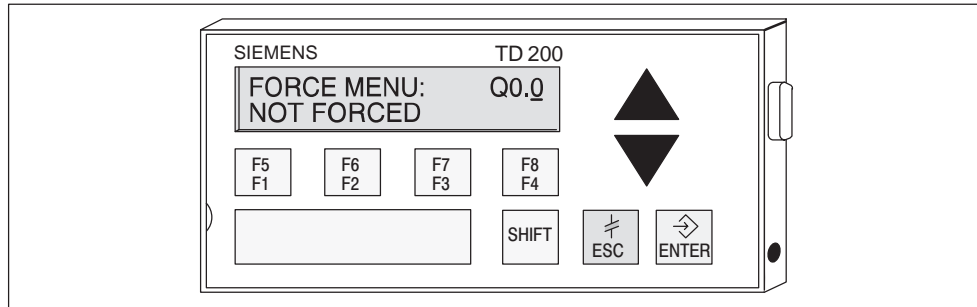

Figure 3-5 Changing the Force Status of an I/O Point

Note

If you wish to change the force status, press ESC to return the cursor to the I/O address.

With the cursor on the I/O address, press ESC to return to the Force I/O menu.

3.6 Setting Time and Date in the CPU

The Set Time and Date option is only available if you set the time-of-day (TOD) menu enable in the TD 200 configuration and if you are using a CPU that supports the TOD clock. If the configuration is not set to allow changes to the time, or if your CPU does not support the TOD clock, you cannot modify the date or time of the CPU.

Figure 3-6 shows you what the TD 200 displays if you try to set the time on an S7-200 CPU that does not contain a clock.

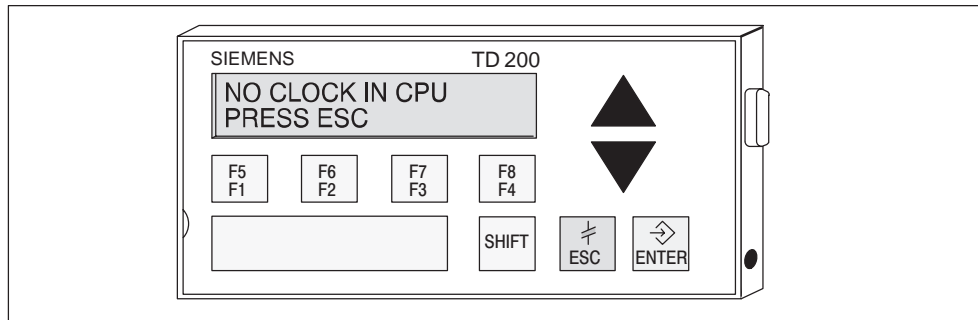

Figure 3-6 No Clock in CPU Display

Accessing the Menu

If the TOD menu enable is set and you are using a CPU that supports a TOD clock, you can access the Set Time and Date menu by performing the following steps.

	Key	Action	Display
1.	ESC	The TD 200 enters the Menu mode.	MENU MODE: VIEW MESSAGES
2.	↓ ↓ ↓	The TD 200 scrolls down the menu options three times.	MENU MODE: SET TIME AND DATE
3.	ENTER	The TD 200 enters the Set Time and Date menu.	28-FEB-95 14:34:12 MONDAY

The TD 200 reads the current date and time from the CPU and displays it. The first line of the display contains the date and time. The second line of the display contains the day of the week.

Note

Pressing ESC at any time while you are setting the time and date returns you to the Display Message mode. The TD 200 automatically returns to the Display Message mode after one minute if no keys are pressed.

Editing the Time and Date

After reading the time from the S7-200 CPU, the cursor is placed on the day-of-the-month field.

To change the time and date, perform the following steps.

1. Use the UP and DOWN arrows to increment or decrement the field under the cursor.
2. Press ENTER when the value is correct. The cursor then moves to the next field.

Note

Pressing ENTER when the cursor is on the day-of-the-week field writes the new time and date to the CPU.

Pressing ESC at any time aborts the edit, rereads the time from the CPU, and returns the cursor to the day field.

Pressing ESC with the cursor on the day field returns you to the Display Message mode.

Note

The TD 200 does not check for illegal dates. Illegal dates can be written to the CPU.

3.7 Releasing the Password

The Release Password option only appears if you have defined a password for the TD 200.

The Release Password option allows the operator to end or pause an editing session and to return the TD 200 to password protection. The password must then be reentered before any editing is allowed.







The TD 200 also has a 2-minute time-out feature which automatically releases the password, thereby restoring password protection. If the keypad is inactive (no keys are pressed) for 2 minutes, the TD 200 prompts the operator to enter the password again before editing.

Note

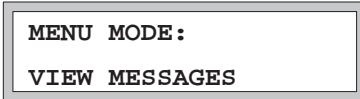
The Release Password option affects only the password protection offered by the TD 200, which restricts the editing of data values that are embedded in a message. The Release Password option is set in the parameter block for the TD 200. The Release Password option does not affect the CPU password that restricts the editing of a user program running on an S7-200 CPU.

Restoring the Password Protection

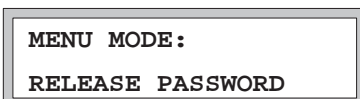
Once you have finished editing, use the following procedure to end your editing session and restore the password protection for modifying variables (you must then reenter the password to make any additional changes):

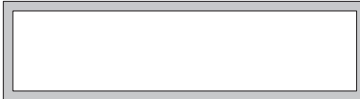
	Key	Action	Display
1.		The TD 200 enters the Menu mode.	
2.	   	The TD 200 scrolls down the menu options four times.	
3.		The TD 200 returns to the password-protected operations.	

3.8 Using the TD 200 Setup Menu Option













The TD 200 Setup menu allows you to set the network address of the TD 200 and the S7-200 CPU, the address of the parameter block (stored in V memory of the CPU), and the baud rate for communication. The network addresses allow the TD 200 to be connected to a network with multiple master and slave devices. Entering the address where the TD 200 looks for its parameter block allows you to have several TD 200 devices connected to a single CPU.

Note

Pressing ESC with the cursor on the left-most character returns you to the Display Message mode. If you change either of the setup values, the TD 200 reinitializes the communications to the CPU.

Setting the Network Address of the TD 200

The Setup Menu allows you to enter the network address for the TD 200. (The default address for the TD 200 is 1.) Use the following procedure to change the network address for the TD 200:















	Key	Action	Display
1.		The TD 200 enters the Menu mode.	
2.	    	The TD 200 scrolls down the menu options five times.	
3.		Press ENTER to move the cursor to the address field. Use the up or down arrow keys to display the correct address.	
4.		Press ENTER to store the new address for the TD 200.	

Note

Pressing ESC at any time while setting the network address for the TD 200 aborts the edit and returns the cursor to the left-most character of the line.

Selecting the CPU Address

The Setup Menu allows you to enter the network address for the CPU. (The default address for the CPU is 2.) Use the following procedure to change the network address for the CPU:

	Key	Action	Display
1.		The TD 200 enters the Menu mode.	
2.	    	The TD 200 scrolls down the menu options five times.	
3.		The TD 200 scrolls down the Setup Menu to the CPU address option.	
4.		Press ENTER to move the cursor to the address field. Use the up or down arrow keys to display the correct address.	
5.		Press ENTER to store the new address for the CPU.	











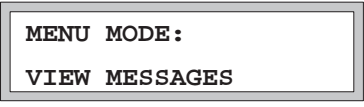

Note

Pressing ESC at any time while setting the network address for the CPU aborts the edit and returns the cursor to the left-most character of the line.

Entering the Parameter Block Address

The Setup Menu allows you to designate a V memory location where the parameter block (or an offset to the location of the parameter block) is stored in the CPU. The default parameter block address is V0. You can enter any V memory address up to V999.

Use the following procedure to enter the V memory address of the parameter block (or the location of the offset to the parameter block):









	Key	Action	Display
1.	ESC	The TD 200 enters the Menu mode.	
2.	    	The TD 200 scrolls down the menu options five times.	
3.	 	The TD 200 scrolls down the Setup Menu to the parameter block address option.	
4.	ENTER	Press ENTER to move the cursor to the address field. Use the up or down arrow keys to display the correct address.	
5.	ENTER	Press ENTER to store the V memory address of the parameter block.	

Note

Pressing ESC at any time while entering the address of the parameter block aborts the edit and returns the cursor to the left-most character of the line.

Selecting the Baud Rate

The Setup Menu allows you to choose the baud rate for the TD 200. You can choose either 9600 baud (9.6 Kbaud) or 19.2 Kbaud. Use the following procedure to enter the baud rate for the TD 200:

	Key	Action	Display
1.	ESC	The TD 200 enters the Menu mode.	<pre>MENU MODE: VIEW MESSAGES</pre>
2.	    	The TD 200 scrolls down the menu options five times.	<pre>SETUP MENU: TD 200 ADDRESS 1</pre>
3.	  	The TD 200 scrolls down the Setup Menu to the baud rate option.	<pre>SETUP MENU: BAUD RATE 9.6K</pre>
4.	ENTER	Press ENTER to move the cursor to the baud rate field. Use the up or down arrow keys to toggle between the baud rates.	<pre>SETUP MENU: BAUD RATE <u>19.2K</u></pre>
5.	ENTER	Press ENTER to store the new baud rate.	<pre>SETUP MENU: BAUD RATE 19.2K</pre>

Note

Pressing ESC at any time while setting the baud rate aborts the edit and returns the cursor to the left-most character of the line.

4

Creating Sample Programs

This chapter provides sample programs that can be used for understanding how the TD 200 performs various tasks.

The first program demonstrates how several variables can be placed on one TD 200 display using ASCII text. A TD 200 and a CPU 214 are used to create a clock. The second program illustrates the bar graph character set.

Chapter Overview

Section	Description	Page
4.1	Using a Text Message to Create a Clock for a CPU 214	4-2
4.2	Using the Bar Graph Character Set	4-5

4.1 Using a Text Message to Create a Clock for a CPU 214

Creating a Sample Program

The following figures show a sample program that you can enter. This program uses a text message to create a clock using a TD 200 and a CPU 214. The text message is created using the Hex To ASCII (HTA) command and the result of the conversion is placed into the proper V memory locations to produce a date and time display. The display shows the date and time as:

month-day-year hour:minute:second

Using the STEP 7–Micro/WIN TD 200 Configuration Wizard

To create the parameter block and messages for the TD 200, you use the TD 200 Configuration Wizard. Select the menu command **Tools > TD 200 Wizard...** as shown in Figure 4-1.

Use the instructions on the following pages to create a TD 200 parameter block in V memory. To advance to the next dialog box, click on “**N**ext>.” At any time in the procedure, you can click on the “<**P**rev” button to go back to a previous dialog box if you need to change or review any of the parameters you have defined.

At the end of the procedure, click on “**F**inish” to validate and save the parameter block. You can view the configured parameter block by opening the data block editor.

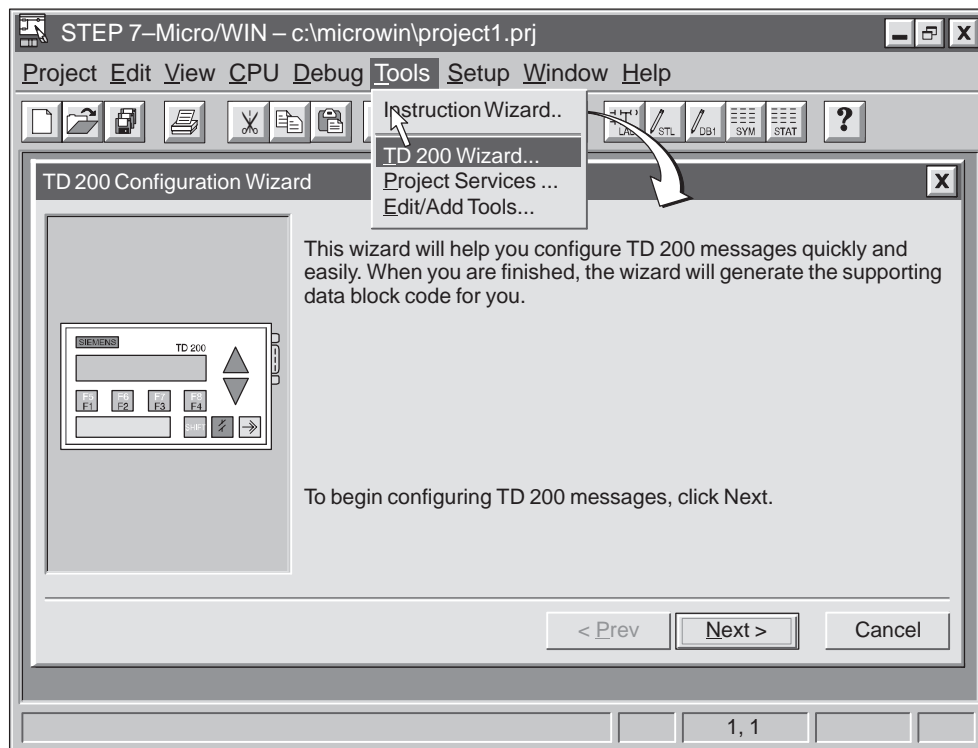

Figure 4-1 Accessing the TD 200 Configuration Wizard

To create the parameter block for this example, use the TD 200 Configuration Wizard and make the following selections:

1. Select English, disable bar graph character set.
2. Enable time-of-day menu, disable force menu, and disable password protection.
3. Reserve marker byte M0 for function keys, update as fast as possible.
4. Select one 20-character message.
5. Select parameter block starting byte at 0, message enables at 12, message information at 20.
6. Set message text: bb-bb-bbbbbbbb:bb:bb, where “b” is a blank space.

Figure 4-2 shows the resulting data block for this clock sample.

```
// BEGIN TD200_BLOCK 0
// (Comments within this block should not be edited or removed)
VB0   'TD'           // TD 200 Identification
VB2   16#10          // Set Language to English, set Update to As fast as possible
VB3   16#20          // Set the display to 20 character mode; Up key V3.2; Down key V3.3
VB4   1              // Set the number of messages
VB5   0              // Set the Function Keys notification bits to M0.0 – M0.7
VW6   20             // Set the starting address for messages to VW20
VW8   12             // Set the starting address for message enable bits to VW12
// MESSAGE 1
// Message Enable Bit V12.7
VB20  ' - - : : '
// END TD200_BLOCK 0
```

Figure 4-2 Data Block of the Clock Message

The program displayed in Figure 4-3 generates the clock when you download all of the blocks to the CPU and put the CPU in RUN mode.

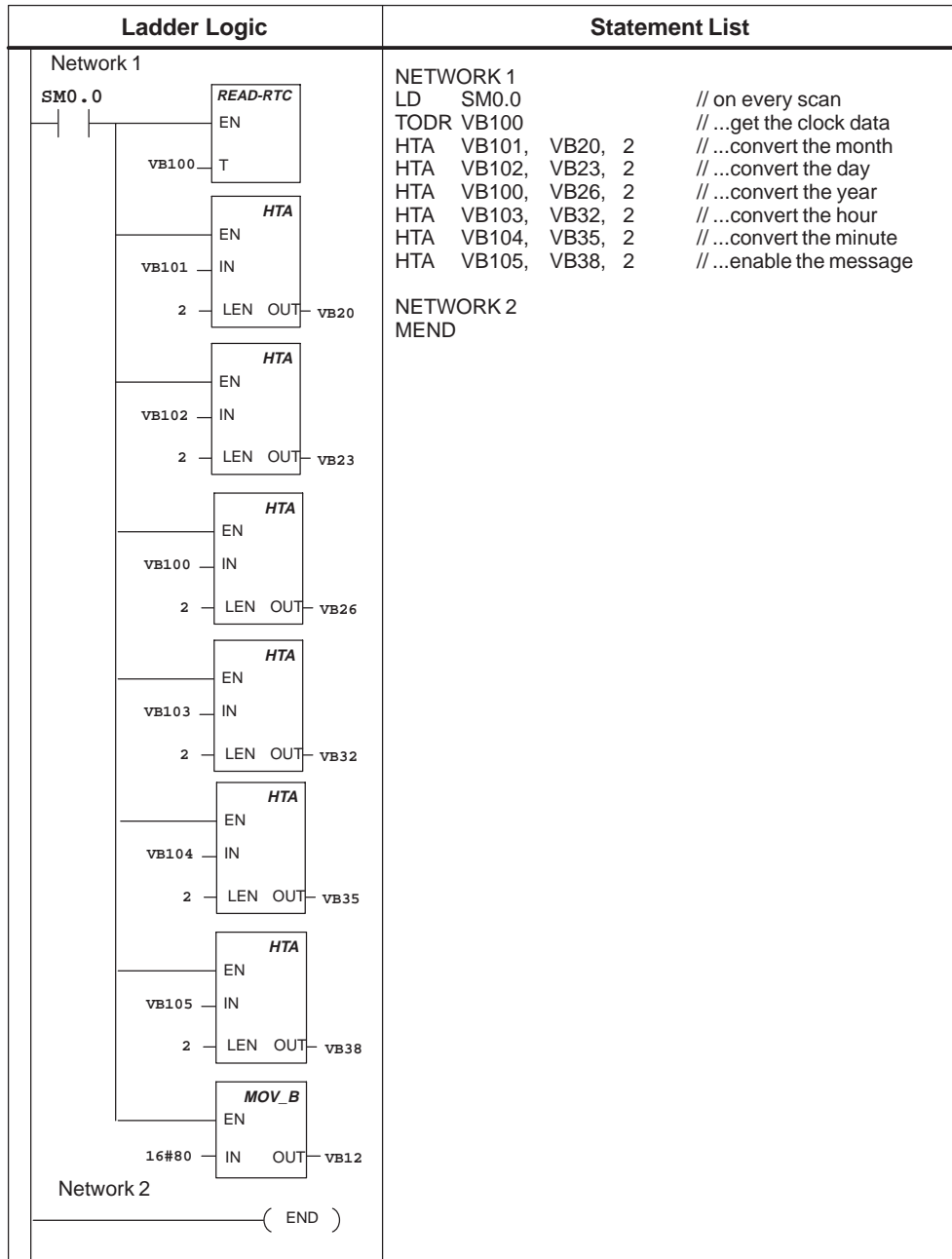

Figure 4-3 Sample Program for Creating a Clock

4.2 Using the Bar Graph Character Set

This sample program illustrates the bar graph character set. Version 1.1 and higher of the TD 200 support the alternate character set for creating a bar graph. Select the menu command **Tools > TD 200 Wizard...**, as shown in Figure 4-1, and use the TD 200 Configuration Wizard to make the following selections:

1. Select English, Enable bar graph character set.
2. Disable time-of-day menu, force menu, and password protection.
3. Reserve marker byte M0 for function keys, update as fast as possible.
4. Select one 40-character message.
5. Select the parameter block starting byte at VB0, message enables at VB12, and message information at VB20.
6. Set message text: bbbbbbbbbbbbbbbbbbbb (where b is a blank)
BAR GRAPH SAMPLE

Figure 4-4 shows the data block generated in this sample.

```
// BEGIN TD200_BLOCK 0
// (Comments within this block should not be edited or removed)
VB0   'TD'           // TD 200 Identification
VB2   16#90          // Set Language to English, set Update to As fast as possible
VB3   16#01          // Set the display to 40 character mode; Up key V3.2; Down key V3.3
VB4   1              // Set the number of messages
VB5   0              // Set the Function Keys notification bits to M0.0 – M0.7
VW6   20             // Set the starting address for messages to VW20
VW8   12             // Set the starting address for message enable bits to VW12
// MESSAGE 1
// Message Enable Bit V12.7
VB20  '              BAR GRAPH SAMPLE  '
// END TD200_BLOCK 0
```

Figure 4-4 Data Block of the Bar Graph Sample Program

After you finish entering the parameters in the wizard, create the program shown in Figure 4-5, download the data block and the program to a CPU, and place the CPU in RUN mode. Adjust potentiometer 0 to display the bar graph.

Note

This example does not produce an exact representation of the analog potentiometer value. The partial bars are approximate.

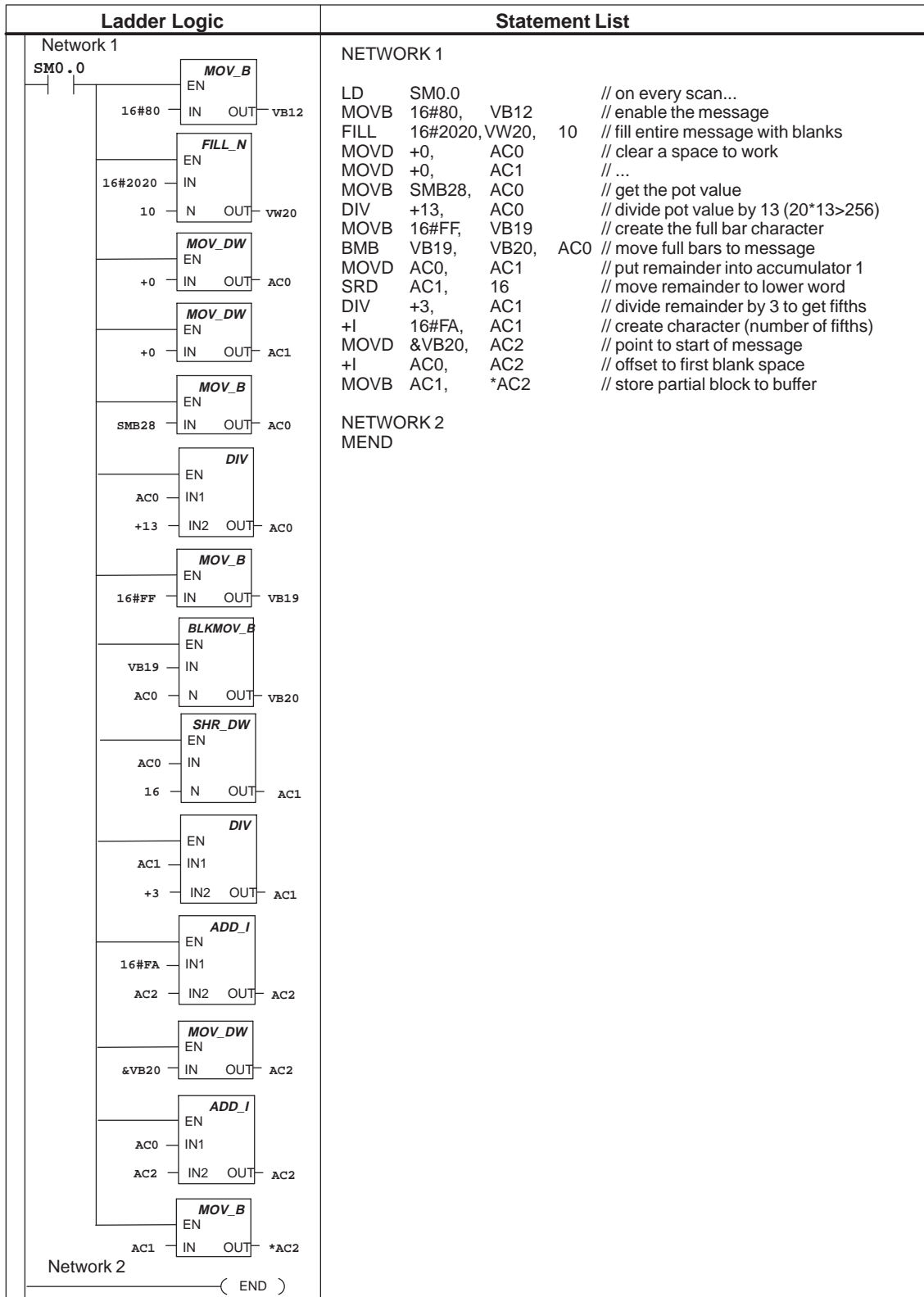

Figure 4-5 Sample Program for Creating a Bar Graph

Specifications and Reference

A

This appendix contains the technical specifications and requirements for the TD 200. It also lists ASCII characters and special ALT key combinations for entering international and special characters.

Chapter Overview

Section	Description	Page
A.1	Certificates, Directives and Declarations	A-2
A.2	Approvals	A-3
A.3	Specifications for Model Number 6ES7 272-0AA00-0YA0	A-4
A.4	ASCII Characters	A-6
A.5	ALT Key Combinations for International and Special Characters	A-7

A.1 Certificates, Directives and Declarations

Notes on the CE Symbol



The following applies to the SIMATIC product described in this operating instruction:

EMC Directive

This product fulfils the requirements for the EC directive 89/336/EEC on “electromagnetic compatibility” and the following fields of application apply according to this CE symbol:

Field of Application	Requirement For	
	Emitted Interference	Noise Immunity
Residential and commercial areas and small businesses.	EN 50081-1: 1992	EN 50082-1: 1992
Industry	EN 50081-2: 1993	EN 50082-2: 1995

Low Voltage Directive

This product fulfils the requirements for the EC directive 73/23/EEC on “low voltage” and was tested to EN60950.

Declaration of Conformity

The EC declarations of conformity and the documentation relating to this are available to the authorities concerned, according to the above EC directive, from:

Siemens AG
Bereich Automatisierungs- und Antriebstechnik
A&D AS E4
Fr. Zisler
Postfach 1963
D-92209 Amberg
Tel.: 09621 80 3283
Fax: 09621 80 3278

Observing the Setup Guidelines

The setup guidelines and notes on safety given in the manual must be observed on startup and during operation.

A.2 Approvals

Approval for USA and Canada

UL/CSA approval

Important for the U.S.A. and Canada:



The characters stamped on a device are indicative of the requirements which that device meets:

Underwriters Laboratories (UL) to the UL 1950 standard, Report E11 5352

Underwriters Laboratories (UL) to the Canadian standard C22.2 No. 950

UL recognition mark

Canadian Standard Association (CSA) to standard C22.2 No. 950 or C22.2 No. 220, Report LR 81690

FM approval to Factory Mutual Approval Standard Class Number 3611, Class I, Division 2, Group A, B, C, D

FM Approval

FM approval to Factory Mutual Approval Standard Class Number 3611, Class I, Division 2, Group A, B, C, D.

Temperature class T4A is adhered to when the ambient temperature during operation does not exceed 45°C.



Warning

Personal injury or property damage can result.

In hazardous areas, personal injury or property damage can result if you close or disconnect an electrical circuit during operation (e.g. plug-in connections, fuses, switches).

Do not close or disconnect any live circuits unless explosion hazards can be definitely excluded.



Warning

WARNING - DO NOT DISCONNECT WHILE CIRCUIT IS LIVE
UNLESS LOCATION IS KNOWN TO BE NON-HAZARDOUS

A.3 Technical Specifications for Model Number 6ES7 272-0AA00-0YA0

Table A-1 Technical Specifications

Description	Technical Specifications
TD 200	
Order number	6ES7 272-0AA00-0YA0
Dimensions (H x W x D)	76 x 148 x 27 mm (2.8 x 5.6 x 1.1 in.)
Weight	approx. 0.22kg
Display	STN-Display / 2 lines of 20 characters each. 5 mm character height / LED backlight / normal temperature range
Keyboard	Membrane keypad / 9 keys
PG - PLC interface	RS 485 (PPI); 9,6 / 19,2 kbit/s
Supply voltage (U_N)	24VDC ¹⁾ , (15VDC...30VDC, safety extra low voltage, supplied by PLC, mains adapter or a 24VDC external supply). The TD 200 has no integrated means of protection against strong interference pulses in the μ s range (surge impulse). If the power being supplied has no appropriate means of protection then a surge voltage protector should be preconnected. 1) The 24VDC power supply must be limited either through an overload limiter or by a 3 A or under rated fuse.
Current consumption (I_N)	typ. 60 mA, (terminating resistors switched off), max. 100 mA at U_N 24V (no fuse in TD 200).
Making current I^2t value	max. 0,02 A ² s (at U_N =24V)
Degree of protection	IP 65 (mounted on the front of the panel) IP 30 (mounted on the casing)
Safety	
VDE regulation	VDE 0805 \triangle EN 60950 \triangle IEC 950
Noise emission	<45dB(A) to DIN 45635 (no fan)
Electromagnetic compatibility (EMC)	
Emitted interference Limit class	B to EN 55022 = CIS PR 22
Noise immunity on signal lines	± 2 kV (to IEC 1000-4-4; Burst)
Noise immunity to discharge of static electricity	± 6 kV Contact discharge (to IEC 1000-4-2; ESD) ± 8 kV Air discharge (to IEC 1000-4-2; ESD)
Conducted interference on AC power supply line	± 2 kV (to IEC 1000-4-4; Burst) ± 1 kV ²⁾ (to IEC 1000-4-5; μ s-impulse (Surge); (line against line)) ± 2 kV ²⁾ (to IEC 1000-4-5; μ s-impulse (Surge); (line against earth)) 2) Power supplies with the same voltage can only be used with additional means of protection. For example, a surge voltage protector available from the Dehn company, type RZ/E 24 V-, order No. 917 204

Table A-1 Technical Specifications

Description	Technical Specifications
Noise immunity to high frequency emission	10 V/m at 80% amplitude modulation at 1 kHz, 9 kHz - 80 MHz (to IEC 1000-4-3) 10 V/m at 80% amplitude modulation at 1 kHz, 80 MHz - 1 GHz (to IEC 1000-4-6) 10 V/m pulse modulated 50% duty cycle at 900 MHz (to IEC 1000-4-3)
Climatic conditions	
Temperature Operation Storage/Transport	Tested to DIN IEC 68-2-1, DIN IEC 68-2-2 ± 0° C to +45 °C (+32° F to +113 °F (rate of temperature change max. 10 °C/h) - 20° C to +60 °C (-4° F to +140 °F (rate of temperature change max. 20 °C/h)
Relative humidity Operation Storage/Transport	Tested to DIN IEC 68-2-3 5% to 85% at 30 °C (no condensation) 5% to 93% at 40 °C (no condensation)
Mechanical environmental conditions	
Vibration Operation Transport (packaged)	Tested to DIN IEC 68-2-6 10 to 58 Hz, amplitude 0,075 mm 58 to 150 Hz, acceleration 9,8 m/s ² 5 - 9 Hz, amplitude 3,5 mm 9 - 500 Hz, acceleration 9,8 m/s ²
Shock Operation Transport (packaged)	Tested to DIN IEC 68-2-27/29 Semisinusoidal: 150 m/s ² (15g), 11 ms Semisinusoidal: 250 m/s ² (25g), 6 ms
Special features	
Quality assurance	In accordance with ISO 9001
Servicing	Maintenance-free (no battery)
Panel mounting	Accessories for panel mounting are enclosed

A.4 ASCII Characters

Table A-2 ASCII Characters for the TD 200

Char	Hex	Dec	Char	Hex	Dec	Char	Hex	Dec	Char	Hex	Dec	Alternate Character
	20	32	>	3E	62	¥	5C	92	z	7A	122	When you select the alternate character set, the following ASCII codes are remapped to display different characters. The other ASCII codes are not changed. See Section D.2 for information about selecting the alternate ASCII characters.
!	21	33	?	3F	63]	5D	93	{	7B	123	
"	22	34	@	40	64	^	5E	94		7C	124	
#	23	35	A	41	65	_	5F	95	}	7D	125	
\$	24	36	B	42	66	`	60	96	→	7E	126	
%	25	37	C	43	67	a	61	97	←	7F	127	
&	26	38	D	44	68	b	62	98	ü	81	129	
'	27	39	E	45	69	c	63	99	ä	84	132	
(28	40	F	46	70	d	64	100	ä	8E	142	
)	29	41	G	47	71	e	65	101	æ	90	144	
*	2A	42	H	48	72	f	66	102	Æ	91	145	
+	2B	43	I	49	73	g	67	103	ä	93	147	
,	2C	44	J	4A	74	h	68	104	ö	94	148	
-	2D	45	K	4B	75	i	69	105	Å	95	149	
.	2E	46	L	4C	76	j	6A	106	ö	99	153	I 90 144
/	2F	47	M	4D	77	k	6B	107	ü	9A	154	II 91 145
0	30	48	N	4E	78	l	6C	108	°	DF	223	III 92 146
1	31	49	O	4F	79	m	6D	109	α	E0	224	IIII 93 147
2	32	50	P	50	80	n	6E	110	β	E1	225	↑ 95 149
3	33	51	Q	51	81	o	6F	111	ε	E3	227	↑ F9 249
4	34	52	R	52	82	p	70	112	μ	E4	228	I FB 251
5	35	53	S	53	83	q	71	113	σ	E5	229	II FC 252
6	36	54	T	54	84	r	72	114	ϕ	EC	236	III FD 253
7	37	55	U	55	85	s	73	115	ñ	EE	238	IIII FE 254
8	38	56	V	56	86	t	74	116	ö	EF	239	IIII FF 255
9	39	57	W	57	87	u	75	117	Ω	F4	244	
:	3A	58	X	58	88	v	76	118	ü	F5	245	
;	3B	59	Y	59	89	w	77	119	Σ	F6	246	
<	3C	60	Z	5A	90	x	78	120	Π	F7	247	
=	3D	61	[5B	91	y	79	121				

A.5 ALT Key Combinations for International and Special Characters

When entering certain international and special characters in the STEP 7-Micro/WIN TD 200 Configuration Wizard, they may not appear correctly on the TD 200 display. If the characters do not display correctly, use the ALT key and number combinations shown in Table A-3 to enter the characters in the TD 200 Configuration Wizard.

Table A-3 ALT Key Combinations for International and Special Characters

Character	ALT Key Combination	Character	ALT Key Combination
ü	Alt-0129	æ	Alt-0164
ä	Alt-0132	Ω	Alt-0234
å	Alt-0145	Σ	Alt-0228
Æ	Alt-0146	Π	Alt-0227
å	Alt-0134	¥	Alt-0157
ñ	Alt-0148	←	Alt-0195 (left arrow ←)
Å	Alt-0143	→	Alt-0180 (right arrow →)
°	Alt-0248		Alt-0200 (single bar)
α	Alt-0224		Alt-0201 (double bar)
β	Alt-0225		Alt-0202 (triple bar)
ε	Alt-0238		Alt-0203 (four bars)
μ	Alt-0230		Alt-0204 (five bars)
σ	Alt-0229	↑	Alt-0194 (up arrow)
¢	Alt-0155		

B

Multiple CPU Configurations

This appendix explains how to connect multiple TD 200s and S7-200 CPUs together on one communication network. The TD 200s act as network masters and do not interfere with one another. The CPUs can be either masters or slaves on the network.

Chapter Overview

Section	Description	Page
B.1	Configuring for Multiple CPU Communication	B-2
B.2	Building a TD/CPU Cable	B-4

B.1 Configuring for Multiple CPU Communication

Figure B-1 shows a typical network. In this figure there are two TD 200s and two CPUs. Each TD 200 communicates to one of the CPUs. The addresses of each device are noted below the device in the figure. Refer to Section 3.8 for information about how to set an address in the TD 200. Refer to the CPU's programming software documentation for help in changing the address of the S7-200 CPU.

In this example, the TD 200 Number 1 is configured to communicate to the CPU at address 2 (CPU Number 1), and TD 200 Number 2 is configured to communicate to the CPU at address 3 (CPU Number 2).

Note

You can connect multiple TD 200s to a single CPU. You can store separate parameter blocks for each TD 200 in different V memory locations in the CPU. See Sections D.1 and 3.8 for more information. If you do not store separate parameter blocks for each TD 200 that is connected to the CPU, any of these TD 200s can acknowledge the same messages and use function keys to initiate operations in the CPU.

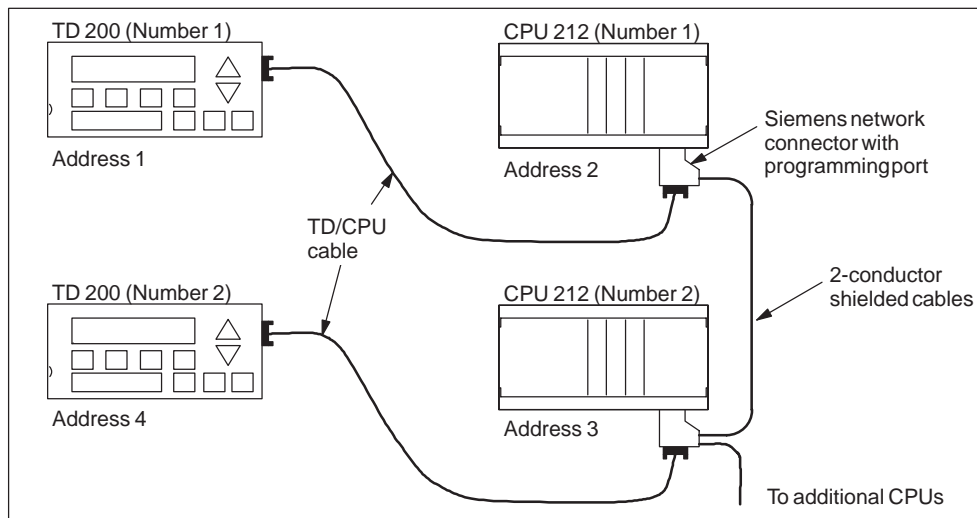

Figure B-1 A Typical Multiple CPU Network

Network connectors are available from Siemens. Using these connectors allows you to isolate the CPUs from one another (the 24 VDC), but still allows you to power the TD 200 from the CPU. See the *SIMATIC S7-200 Programmable Controller System Manual* for more information on using network connectors.



Warning

The CPUs provide 24 VDC on the communication connector to power devices such as the TD 200.

You must not connect the 24 VDC lines between CPUs. Doing so could result in damage to the CPUs.

You must only connect communication lines (pins 3, 5, and 8), not power lines (pins 2 and 7), when networking CPUs.

Note

When you connect a PG 702 to a network of CPUs and TD 200s, the PG 702 does not function if there are more than three TD 200s.

Note

The display update time slows as more TD 200s are added to the network.

B.2 Building a TD/CPU Cable

The TD/CPU cable is used for connecting a display device to an S7-200 CPU. If you do not have a TD/CPU cable, refer to Figures B-2 and B-3 to create your own cable.

Making a Cable That Supplies Power to the TD 200

Figure B-2 shows you the pin-out of TD/CPU cable with power supplied to the TD 200. Use this option when you want the TD 200 to receive power from an S7-200 CPU.

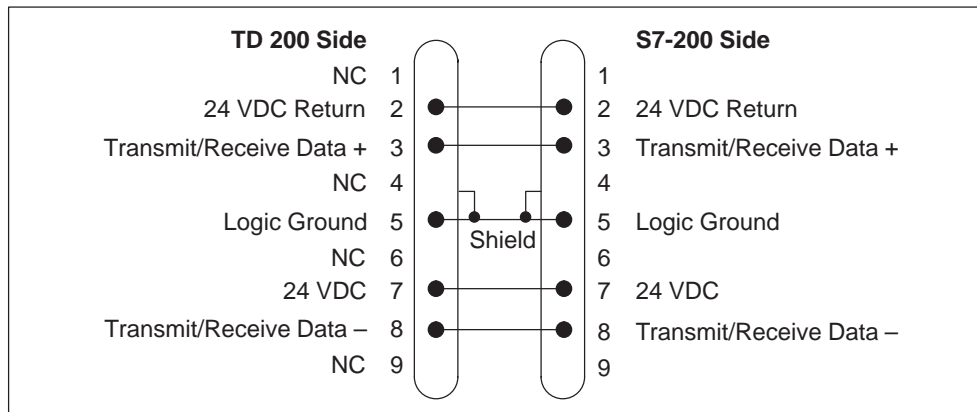

Figure B-2 TD/CPU Cable with Power Connections

Making a Cable That Does Not Supply Power to the TD 200

Figure B-3 shows you the pin-out of a TD/CPU cable without power supplied to the TD 200. Use this option when you want the TD 200 to receive power from an external power supply. The maximum length for the cable is 1200 meters.

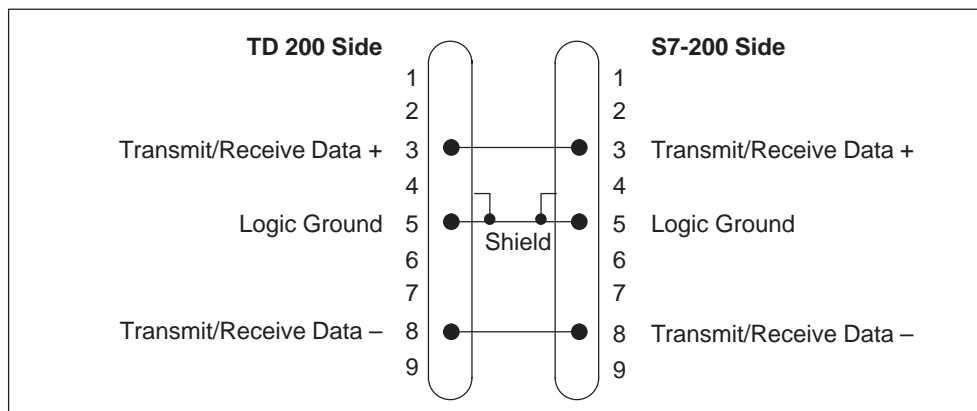

Figure B-3 TD/CPU Cable without Power Connections

Troubleshooting

C

Refer to Table C-1 for a list of the problems that could occur with the TD 200 and possible causes and solutions.

Table C-1 Troubleshooting Table

Problem	Possible Cause	Solution
NO PARAMETER BLOCK	The TD 200 could not find a parameter block in the programmable logic controller.	Configure a parameter block for the TD 200 in the programmable logic controller. Refer to Chapter 2.
		Be sure the parameter block address in the TD 200 matches the actual address of the parameter block. Refer to Section 3.8.
	The TD 200 found a parameter block in the programmable logic controller, but it contains errors.	Be sure all fields are within range.
		Be sure all addresses are legal for the CPU. Refer to Section D.2.
CPU NOT RESPONDING	Address of the CPU is incorrect.	Correct the address errors. Refer to Section 3.8.
	CPU does not have power.	Power up the CPU.
	Cable problems.	Check the cable connections.
	Wrong baudrate configured.	Correct the baud rate configuration. Refer to Section 3.8.
	Multiple CPUs at the same address.	Remove other CPUs and retry.
	May need network terminations.	See <i>SIMATIC S7-200 Programmable Controller System Manual</i> .
	Network too long or too many devices on network.	See <i>SIMATIC S7-200 Programmable Controller System Manual</i> .
HARDWARE ERROR	TD 200 is inoperable.	The TD 200 module could be defective. Replace with a new module.

Table C-1 Troubleshooting Table

Problem	Possible Cause	Solution
NETWORK ERROR (TD 200 cannot establish a network connection or enter an existing network.)	May be multiple masters with the same address.	Remove other masters and retry.
	Cable problems.	Check the cable connections.
	Multiple CPUs at the same address.	Remove other CPUs and retry.
CPU BUSY	Some other master has locked the CPU by uploading or downloading a program to that CPU.	Wait — it disappears in a few seconds.
CPU IN STOP MODE	RUN/STOP switch is in STOP.	Put CPU in RUN mode.

D

TD 200 Parameters and Messages

Software Support for Configuring a TD 200

Some programming packages include a configuration utility for entering the parameter block and messages for the TD 200. For example, version 1.2.1 of STEP 7-Micro/DOS uses Utility 24 for configuring the TD 200. STEP 7-Micro/WIN provides a “wizard” that makes it easy to configure the parameter block and the messages in the data memory area of the S7-200 CPU (see Chapter 2). Refer to your programming software and its documentation to determine whether it supports a TD 200 configuration utility.

Chapter Overview

Section	Description	Page
D.1	TD 200 Parameter Block	D-2
D.2	Building the Parameter Block	D-4
D.3	Formatting Messages	D-9
D.4	Embedding Data Values in a Text Message	D-11
D.5	Understanding Message Types	D-20
D.6	Editing Variables with the TD 200	D-22

D.1 TD 200 Parameter Block

Understanding How Messages Are Displayed

The messages that the TD 200 displays are stored in the CPU. These messages contain ASCII text, embedded values, and format information. The CPU enables the messages through the use of a table of message-enable bits. There must be one message bit allocated in V memory for each configured message. When the program in the CPU says to display a message, the program sets that particular message-enable bit. The TD 200 continuously polls the message-enable bits, and if one of the bits is set, the TD 200 reads the corresponding message from the CPU and writes the message to the display.

Understanding How the TD 200 Uses the Parameter Block

A TD 200 parameter block contains the TD 200 configuration information, and must be created in the data memory (V memory) area of the S7-200 CPU in order to establish an interface between the CPU and the TD 200. The TD 200 monitors the CPU for either a parameter block identifier (ASCII characters "TD") or an offset to the parameter block.

If the TD 200 does not find the parameter block identifier ("TD") in VW0, it uses the value stored in VW0 as an offset to the TD 200 parameter block (see example in Section 2.1). When the parameter block identifier is found, the next 8 or 10 bytes provide the TD 200 with configuration information.

You can change the V memory address for the parameter block by means of a setup menu. (See Section 3.8.) This allows you to connect two TD 200 units to one CPU, with each TD 200 displaying different messages. Figure D-1 shows two TD 200s connected to a single CPU. The parameter blocks for each of the TD 200 are stored in different V memory locations.

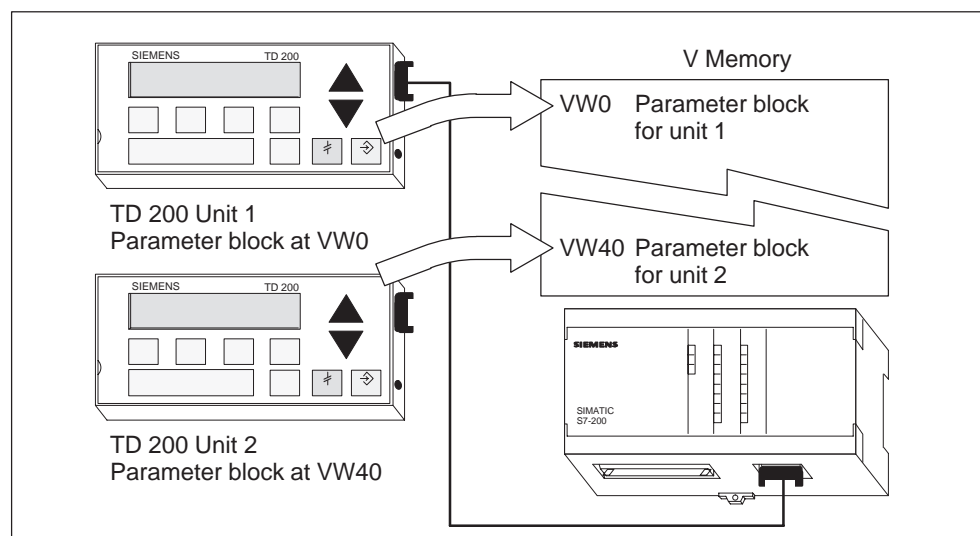

Figure D-1 Displaying Different Messages on Two TD 200 Units

The default location of the parameter block is VW0, but you can store the parameter block (or the offset to the parameter block) in any V memory location between VW0 and VW999. (Use the Setup menu to change the location of the parameter block. See Section 3.8.) If you change the location of the parameter block, the TD 200 looks to that location for either the parameter block or the offset to the parameter block.

If the parameter block identifier cannot be found, the error message **NO PARAMETER BLOCK** is displayed. The TD 200 continues to monitor VW0 (or the V memory location entered by means of the Setup menu) for either a valid parameter block ID or an offset to a parameter block with a valid parameter block ID.

Note

The TD 200 defaults to address 1 and attempts to communicate to a CPU at address 2. See Section 3.8 to change the network addresses if other addresses are used.

Description of the Parameter Block Format

The parameter block consists of 10 or 12 bytes of memory which define the modes of operation and point to the location in CPU memory where the actual messages are stored, as shown in Figure D-2. When you power up the TD 200, it looks for a parameter block identifier in the CPU at VW0, either the ASCII characters “TD” or an offset to the parameter block location, and it reads the data contained in the block.

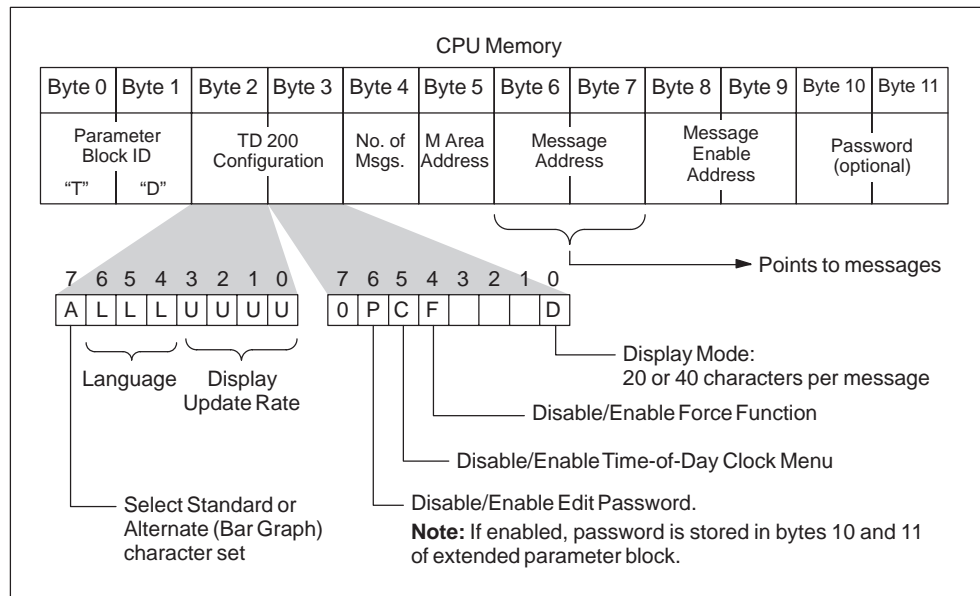

Figure D-2 TD 200 Parameter Block

D.2 Building the Parameter Block

Parameter Block ID Bytes 0 and 1

The TD 200 monitors the CPU for messages. To display the messages, it must first locate the parameter block that contains the block ID information "TD". The TD 200 parameter block is identified by two bytes; byte 0 must be the ASCII character "T" and byte 1 must be the ASCII character "D".

TD 200 Configuration Bytes 2 and 3

Byte 2 of the TD 200 parameter block allows you to configure the desired language and the update time. Figure D-3 shows the information contained in Byte 2 of the parameter block.

- **(L) Language** The language selection determines the display language of the TD 200 menus.
- **(U) Update Rate** The update rate selection determines how often the TD 200 polls the S7-200 CPU for messages to display. The actual update time may be slower depending on the size of the message and the processing required.
- **(A) Alternate Character Set** The character set selection enables the use of an alternate character set designed for displaying bar charts on the TD 200. See Appendix A.

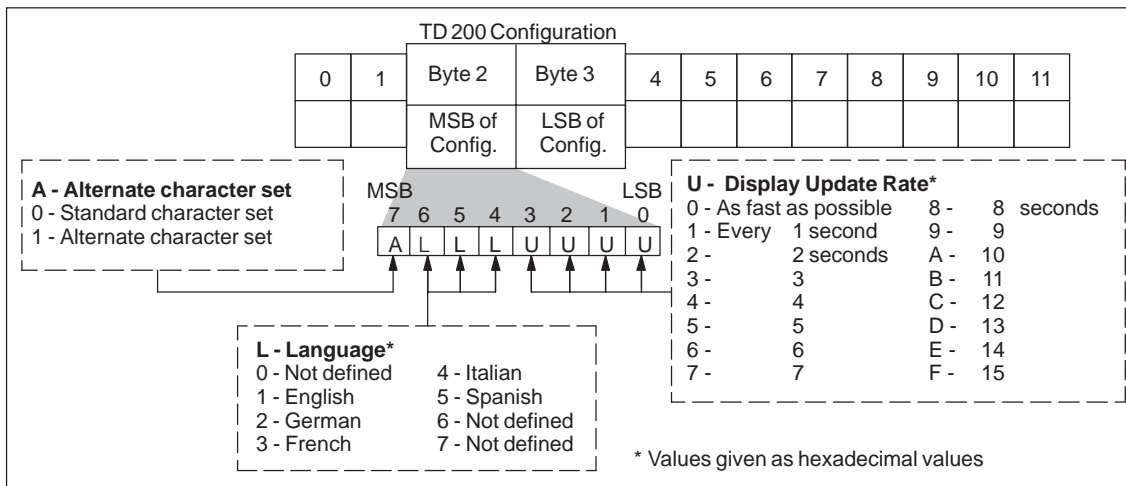

Figure D-3 Information Contained in Byte 2 of the TD 200 Parameter Block

Byte 3 of the TD 200 parameter block allows you to enable the Time-of-Day (TOD) and Force menus, to select either 20- or 40-character display mode, and/or to enable password protection (before allowing any editing). It also contains bits which are set when either the UP or DOWN arrow keys are pressed.

- **(C) TOD Clock and (F) Force** The TOD Clock and Force selections allow you to selectively enable the TOD Clock menu and/or the Force menu. Once either is enabled, you are allowed to access that function in the TD 200. If the function is not enabled, it does not appear in the TD 200 Menu mode.
- **(D) Display Mode** The display mode selection allows you to choose whether display messages are one line (20 characters) or two lines (40 characters).
- **(P) Edit Password** The edit password selection allows you to enable a four-digit password (using 0000-9999) to authorize an operator to edit variables embedded in a message. The password itself is stored in bytes 10 and 11 of the parameter block.
- **(UA and DA) Up Arrow and Down Arrow** The up/down arrow status bits allow your program additional control of the TD 200 display. The TD 200 sets these bits in the controller if you press these keys while the TD 200 is in display mode, assuming there is no more than one message active. If your program uses these bits, the program must reset these bits after they are used.

Figure D-4 shows the information contained in Byte 3.

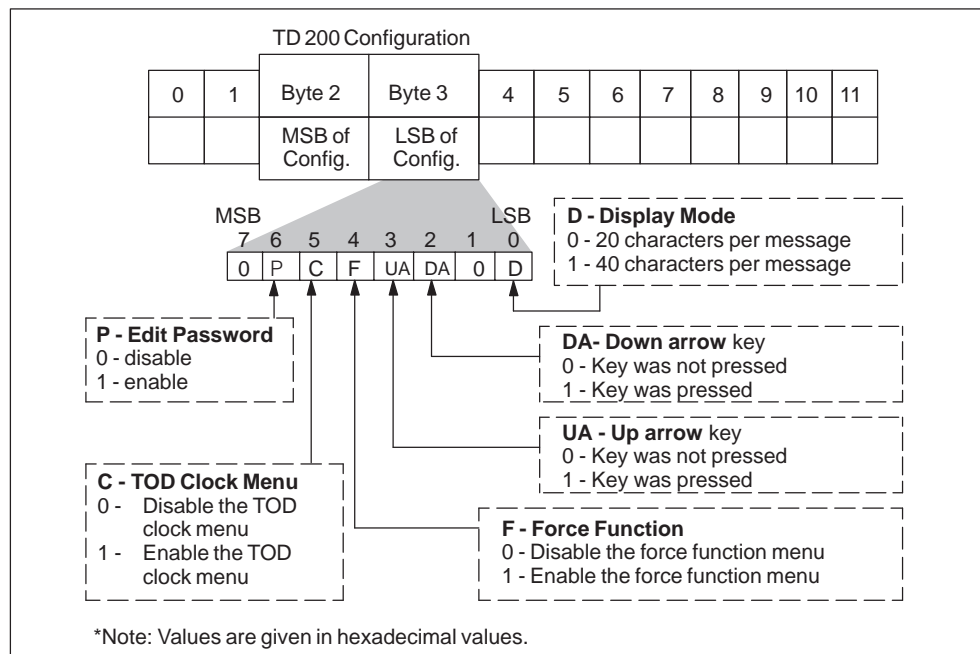

Figure D-4 Information Contained in Byte 3 of the TD 200 Parameter Block

Number of Messages Byte 4

Byte 4 of the TD 200 parameter block defines the number of messages you have configured. The TD 200 accepts values 0 to 80.

Prioritizing Messages

To ensure that you receive the most important message first, the TD 200 uses a fixed priority scheme. In this scheme, a higher priority message displaces a lower priority message. There is one message-enable bit for each message. Therefore, you can have from 0 to 80 message-enable bits corresponding to the number of messages. You must not use message-enable bits for any other purpose other than enabling messages. The TD 200 requires that you allocate full bytes for message-enable bits.

Messages are numbered in ascending order starting with message 1. Message 1 is located at the message address specified by configuration bytes 6 and 7 of the TD 200 parameter block. Byte 0 of the message-enable bits is located at the message-enable address specified by configuration bytes 8 and 9 of the TD 200 parameter block. The highest priority message is message 1 and the lowest priority message is message 80. See Section D.5 for more information on message priorities and the display of messages.

Figure D-5 shows the prioritization scheme and the correspondence between message-enable bits and messages.

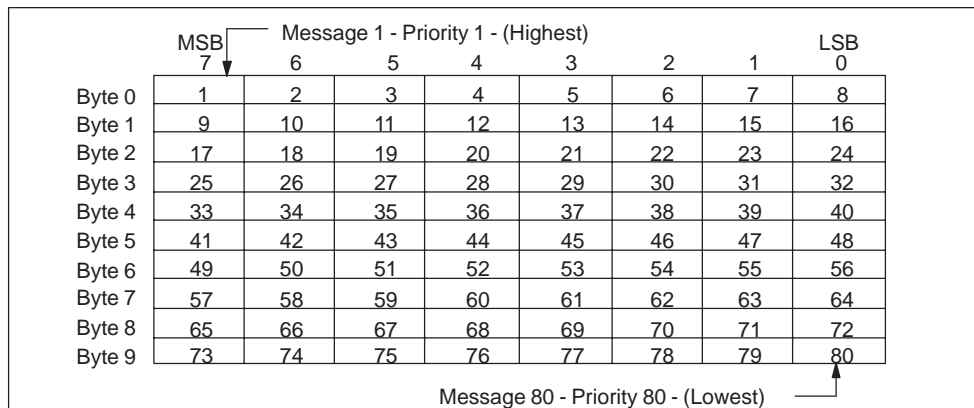

Figure D-5 Message-Enable Bits for up to 80 Messages

M Area Address Byte 5

You must reserve eight bits of marker memory (M bits) for the TD 200 to use when a function key is pressed. Your program can inspect these bits and take the appropriate action when a key is pressed. One M bit is set by the TD 200 each time the corresponding function key is pressed.

Note

The TD 200 does not automatically reset the function-key M bits after they are set. If you use these bits within your program, you must then reset them from within your program.

Byte 5 of the TD 200 parameter block defines the address of the byte of M bits. Valid address values for specific CPUs are defined in the *SIMATIC S7-200 Programmable Controller System Manual*.

Figure D-6 shows a referenced byte (MBn) and shows which bit of the byte is set by each function key.



Warning

The TD 200 sets an M bit each time a function key is pressed. If you do not intend to use function keys, and therefore do not assign an M byte address for function keys, the TD 200 defaults to byte M0 for the function keys. If your program uses bits in M0, and a user presses any function key, the TD 200 sets the corresponding bit in M0, overwriting the value assigned to that bit by your program.

Inadvertent changes to M bits could cause your program to behave unexpectedly. Unpredictable controller operation could cause death or serious injury to personnel, and/or damage to equipment.

Always reserve an M area address, even when your program does not utilize function keys.

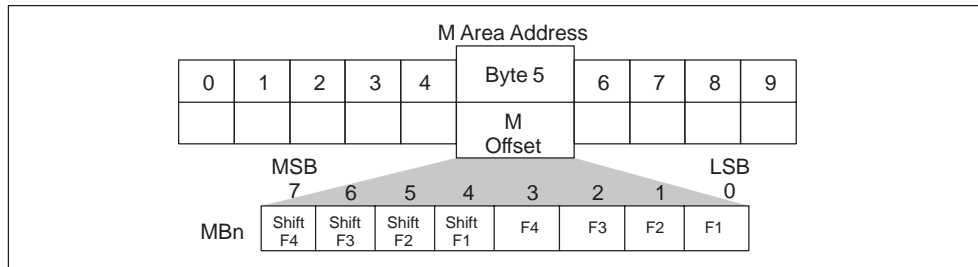

Figure D-6 Bits Set by Each Function Key

Message Address Bytes 6 and 7

Bytes 6 and 7 of the TD 200 parameter block define an integer-word offset in V memory where the TD 200 looks for the first message. Valid offset values for specific CPUs are defined in the *SIMATIC S7-200 Programmable Controller System Manual*.

Note

Each 20-character message uses 20 VB memory locations; each 40-character message uses 40 VB memory locations.

Message-Enable Address Bytes 8 and 9

Bytes 8 and 9 of the TD 200 parameter block define the integer-word offset in V memory where the TD 200 looks for the first byte of the message-enable bits. Valid offset values for specific CPUs are defined in the *SIMATIC S7-200 Programmable Controller System Manual*.

For example: if you assign VB50 as the message-enable address, the first message is enabled by bit V50.7, the second message by V50.6, the third message by V50.5, and the eighth message by V50.0.

You must not use message-enable bits for any purpose other than enabling messages. The TD 200 requires that you allocate full bytes for message-enable bits.

Note

You can set or clear the message-enable bits from within your program. The TD 200 may also clear the message-enable bit following an acknowledge or an edit. See Section D.6 for more information.

Edit Password Byte 10 and 11 (Optional)

Bytes 10 and 11 of the TD 200 parameter block store a password that allows you to edit the configuration of the TD 200 or to change variables. This password is a four-digit integer (from 0000 to 9999). Byte 3 of the parameter block enables the password protection. If you enable the password protection by setting the password bit in byte 3, you must enter a password in bytes 10 and 11; however, if you do not enable password protection in byte 3, you are not required to store a password in bytes 10 and 11.

D.3 Formatting Messages

Messages can contain multiple text fields, format words, and variables. The TD 200 allows two message sizes.

- 20-character message mode - displays two messages at a time
- 40-character message mode - displays one message at a time

Once you choose a message size, all messages must correspond to that size. The size is selected on a system basis in the parameter block, and not on a per-message basis. The TD 200 uses the setting of the message size to index the messages stored in the S7-200 CPU V memory.

In applications where alarm or fault conditions can occur and notification is essential, you can configure the TD 200 to display multiple messages.

This section shows you how to create a 20- or 40-character message.

Note

A message cannot have more than six variables. Additional variables are ignored and the variable positions in the display remain blank.

Twenty-Character Message Format

The 20-character message format requires 20 bytes of V memory storage in the S7-200 CPU for each message. Each message is displayed on one line of the TD 200 display, allowing two messages to be shown at the same time. Figure D-7 shows an example of how a 20-character message can be formatted in the CPU and displayed on the TD 200.

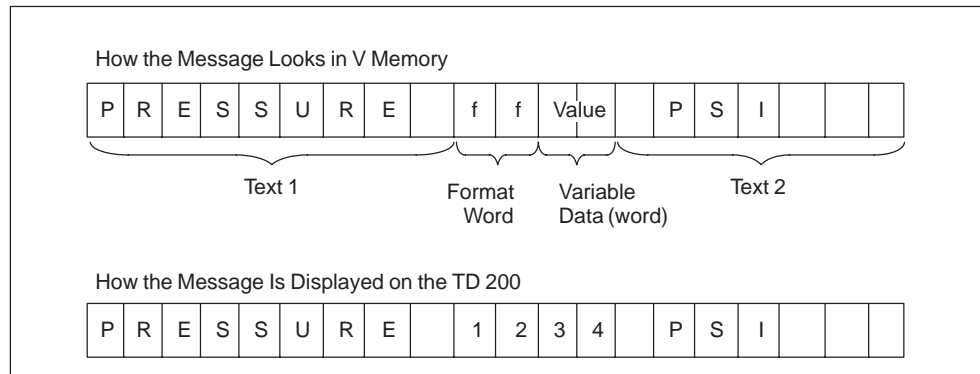

Figure D-7 Twenty-Character Message Format

Forty-Character Message Format

The 40-character message format requires 40 bytes of V memory storage in the S7-200 CPU for each message. Each message requires both lines of the TD 200 display, allowing only one message to be shown at a time. Figure D-8 shows an example of how a 40-character message can be formatted in the CPU and displayed on the TD 200.

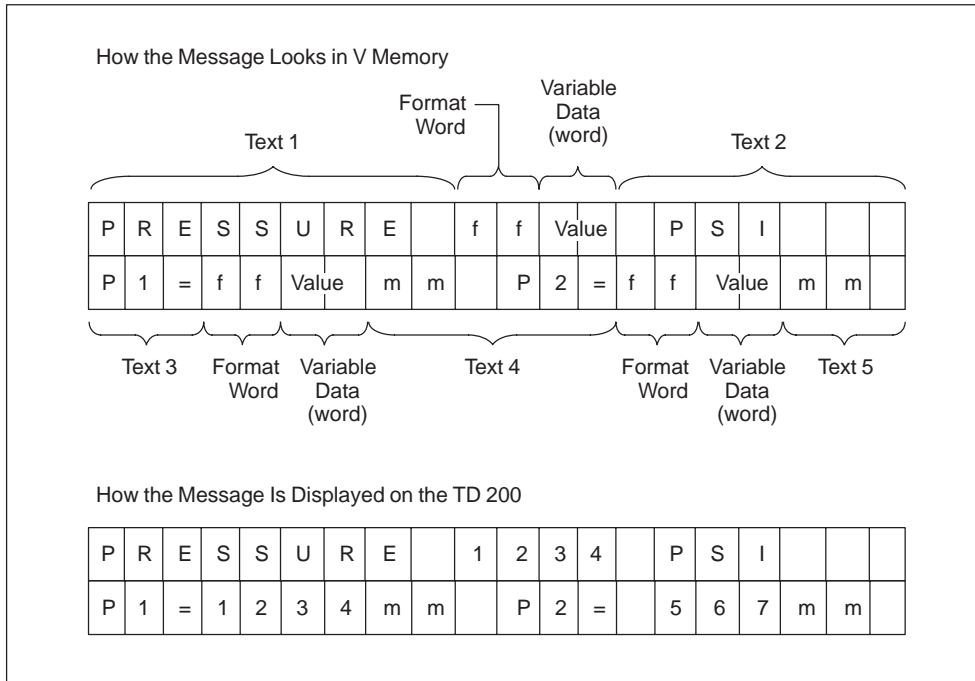

Figure D-8 Forty-Character Message Format

D.4 Embedding Data Values in a Text Message

The TD 200 allows you to place data values within the message that you want to display. You can display and edit these embedded values. Each embedded value must be preceded by a format word which defines how the value is displayed and whether the message requires acknowledgement.

Data Value Format Options

The format word in a message provides the following information:

- How the value is displayed—signed or unsigned; word, double word, or real (floating-point); and decimal position
- Whether or not the message requires acknowledgement
- Whether the optional data value is editable
- Whether editing requires a password

You can use format words alone, with an optional word value, with an optional double word value, or with an optional real (floating-point) value. The format word uses two bytes of your message if it is not followed by a data value, four bytes of your message if the format word is followed by a word value, and six bytes of your message if the format word is followed by a double word value or a real (floating-point) value. Figure D-9 shows each type of format word usage.

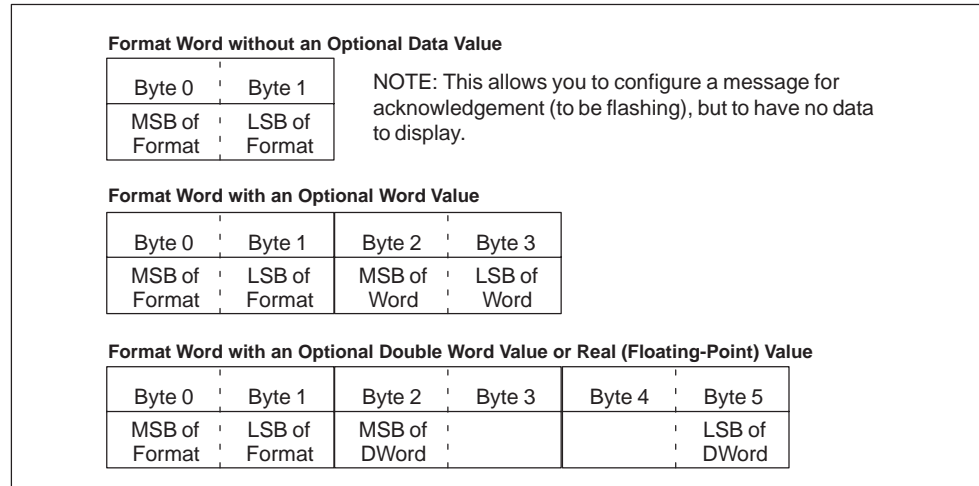

Figure D-9 Format Word Usage

Defining the Data Value Format

Figure D-10 shows the bit values of Byte 0 and Byte 1 of the format word. Byte 0 uses only five bits (bits 0 through 4). Byte 1 uses only six bits (bits 0, 1, 2, and 4, 5, 6). All other bits of the byte (for both Byte 0 and Byte 1) must be set to zero.

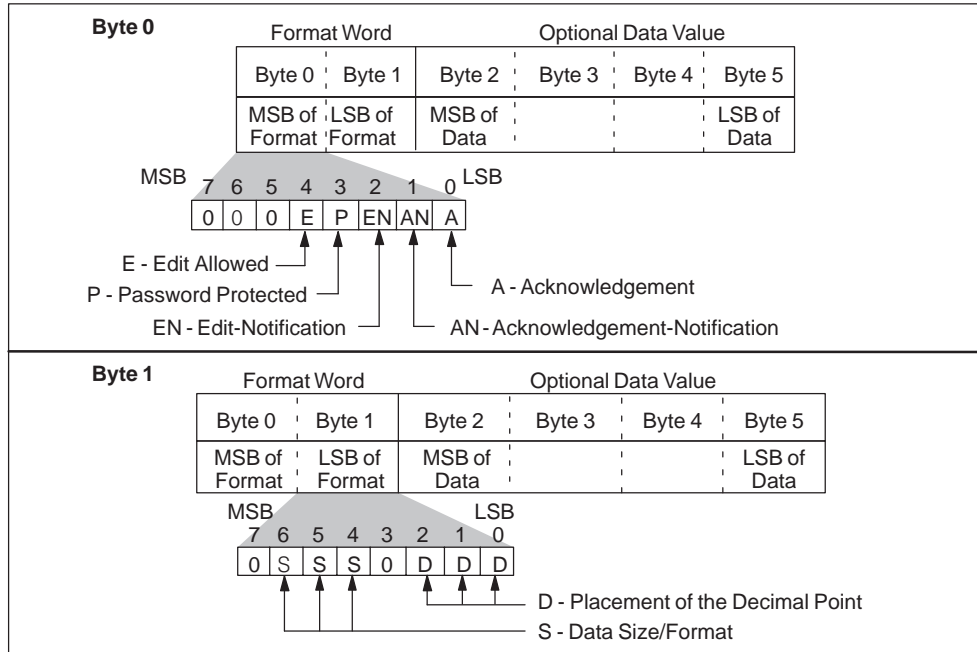

Figure D-10 Bit Values of the Format Word

Do not use non-printable characters in your message text: the TD 200 uses these characters to identify the start of a format word. The non-printable characters are ASCII codes 0 to 31 (0 to 1F hexadecimal).

Acknowledgement Bit 0

To ensure that important messages are displayed and acknowledged by an operator, you can program a message to require acknowledgement. You do this by setting the acknowledgement bit in the most significant byte of the format word. Figure D-11 shows the placement of the acknowledgement bit in byte 0 of the format word.

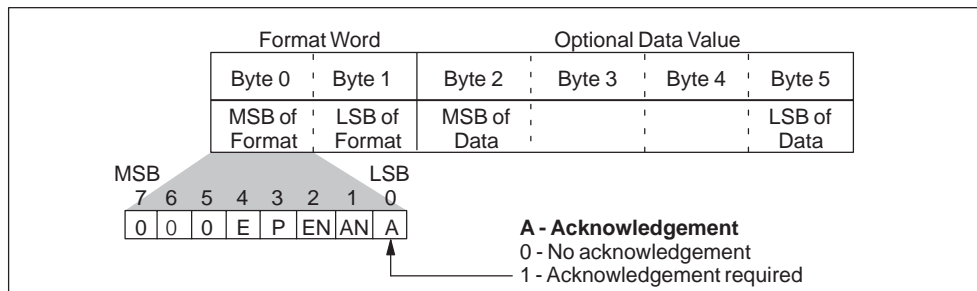

Figure D-11 Acknowledgement Bit of Byte 0 of the Format Word

If you have more than one format word in a message because you have more than one embedded value in the message, you only need to set the acknowledge bit in the first format word of the message. The TD 200 ignores the acknowledge bit in all subsequent format words of the message.

When a message requiring acknowledgement is enabled for display:

- The TD 200 displays the message and causes it to flash.
- The message is not removed or replaced on the TD 200 display, and continues to flash, until the operator acknowledges it by pressing ENTER.
- The TD 200 sets the acknowledge-notification bit and removes the message after the operator presses ENTER.

See Section D.5 for more information about how the TD 200 processes messages with acknowledgement.

Acknowledge-Notification Bit 1

The S7-200 CPU program uses the acknowledge-notification bit to note that the operator has seen and acknowledged a message. To acknowledge a message,

1. Move the cursor to the display line requiring acknowledgement and
2. Press ENTER.

After the operator presses ENTER, the TD 200 sets the acknowledge-notification bit. The S7-200 program uses the acknowledge-notification bit to note that the operator has acknowledged the message. You must design your S7-200 program to reset this bit if you want subsequent notification. Figure D-12 shows the acknowledge-notification bit, located in byte 0 of the format word.

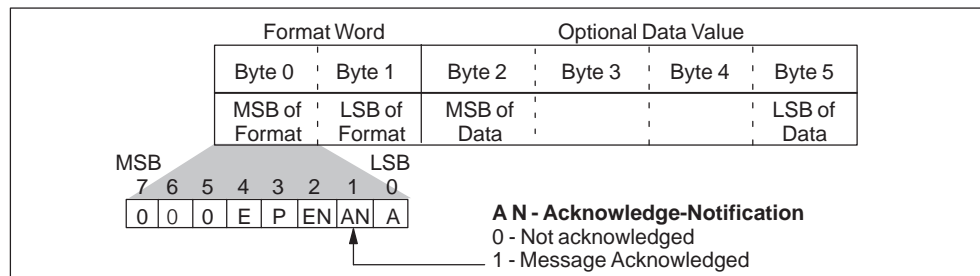

Figure D-12 Acknowledge-Notification Bit of Byte 0 of the Format Word

You can design your S7-200 program to take other actions as a result of setting the acknowledge-notification bit. Figure D-13 shows how you can use the acknowledge-notification bit. For this example, VB21 is assumed to be the most significant byte of the first format word of the message.

Ladder Logic	Statement List
<p>Network #</p>	<pre>// Resetting the acknowledge-notification // bit and using it to enable the next // message LD V21.1 // When the operator acknowledges the R V21.1,1 // message, reset the bit and enable // the next message MOVB ... // Move ...</pre>

Figure D-13 Sample Program for Using the Acknowledge-Notification Bit

Edit-Notification Bit 2

The TD 200 sets the edit-notification bit to 1 after an edit. The CPU can read this edit-notification bit value to recognize when an editable data value has been changed. The program can then read and make use of the edited value.

Note

The edit-notification bit does not reset automatically when subsequent edits are performed. If you want the TD 200 to detect and notify you of a second edit operation, you must design your program to reset the edit-notification bit to zero. Figure D-14 shows the placement of the edit-notification bit, located in byte 0 of the format word.

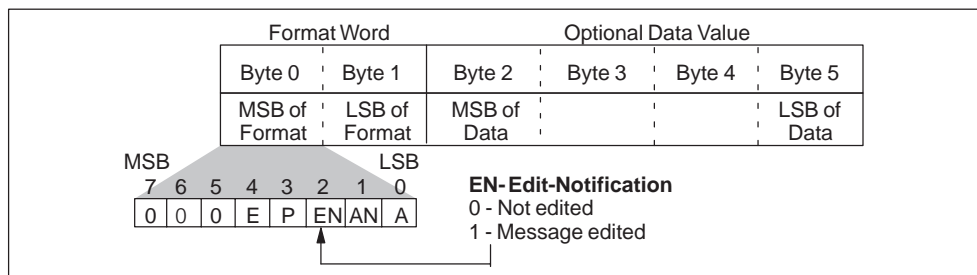

Figure D-14 Edit-Notification Bit of Byte 0 of the Format Word

If an embedded value is set to allow editing, you must design your S7-200 program to check the edit-notification bit. When the embedded value is modified by the user, your program must read the value and take any necessary action with it.



Caution

The edited (new) value that the user enters in an embedded message can be overwritten by the value that was displayed in the message before the edit.

This could cause you to lose the newly edited value.

If you allow an embedded value to be edited, you must design your program to check the edit-notification bit and to move and/or save the edited (new) value each time there is an edit.

If a value is set to allow editing, you can move the cursor to the embedded value and increment or decrement the value by using the UP and DOWN arrows. The SHIFT-UP/DOWN arrow keys allow you to move to specific characters within the variable. The longer you press the arrow key, the faster the value changes.

After you have changed the embedded value to the desired value, you must press ENTER. Pressing ENTER causes the TD 200 to send the edited value to the S7-200 CPU and sets the edit-notification bit in the format word preceding the embedded value.

Figure D-15 shows an example of how you can use the edit-notification bit. For this example, VB21 is assumed to be the most significant byte of the first format word of the message, and the embedded value is a word-sized value immediately following the format word (located in VW23).

Ladder Logic	Statement List
<p>Network #</p> <p>Network #</p>	<pre> //Using the edit-notification bit to copy // the edited value, and then resetting // the notification bit. // LD V21.2 // When the operator edits the embedded R V21.2, 1 // value, reset the bit and copy the edited MOVWVW23,VW250 // value to the variable location. // LD SM0.0 // On each scan ... MOVWVW250,VW23 // copy the variable to the location of the // embedded value. </pre>

Figure D-15 Sample Program for Using the Edit-Notification Bit

Password Protection Bit 3

Setting bit 3 in byte 0 of the format word (see Figure D-16) enables you to require that a password be entered before allowing a variable to be edited from the TD 200. This password (a four-digit integer from 0000 to 9999) is stored in bytes 10 and 11 of the parameter block.

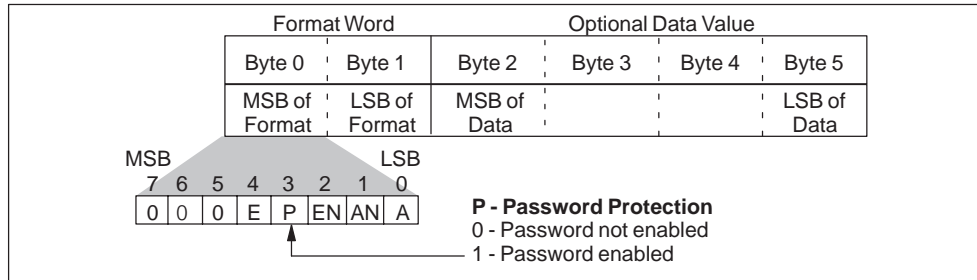

Figure D-16 Password Protection Bit of Byte 0 of the Format Word

Edit-Allowed Bit 4

Figure D-17 shows the edit-allowed bit that is used by the TD 200 to determine whether or not you can edit a data value. If the edit-allowed bit is set, the TD 200 sets the edit-notification bit (bit 2 in byte 0 of the format word) after you have edited the data value.

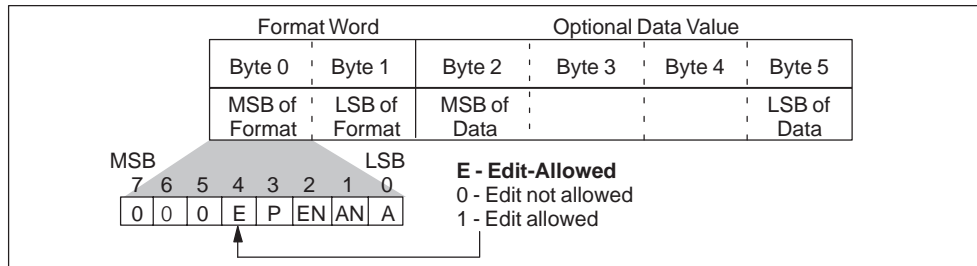

Figure D-17 Edit-Allowed Bit of Byte 0 of the Format Word

Data Size/Format, and Decimal Bits 0, 1, 2 and 4, 5, 6

The least significant byte of the format word is used to specify the size, the format, and the position of the decimal point in a displayed value. The selection of signed or unsigned affects the editing range of a value. Unsigned values are restricted to positive numbers. Signed values can be either positive or negative. Figure D-18 shows the placement of the data size/format and decimal point bits in byte 1 of the format word.

- Unsigned words have a range from 0 to 32,767
- Signed words have a range from -32,768 to 32,767
- Unsigned double words have a range from 0 to 2,147,483,647
- Signed double words have a range from -2,147,483,648 to 2,147,483,647
- Real (floating-point) numbers have a range from $\pm 1.7549 \cdot 10^{-38}$ to $\pm 3.40282 \cdot 10^{38}$.

Note

Due to the size of the display, the TD 200 can display real numbers between $1 \cdot 10^{-7}$ and $9.99999 \cdot 10^{19}$. Values smaller than $1 \cdot 10^{-7}$ are displayed as "0", and values larger than $9.99999 \cdot 10^{19}$ are displayed as "eeeeeee".

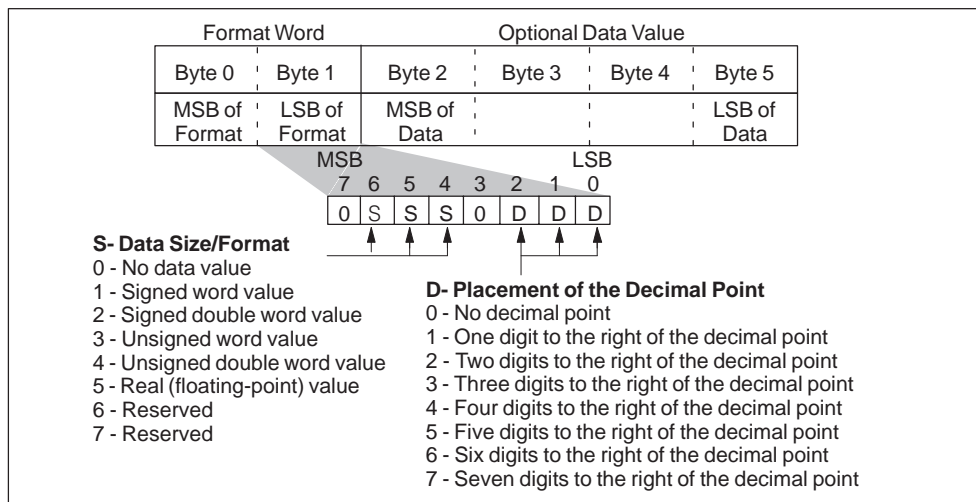

Figure D-18 Bit Values of Byte 1 of the Format Word

The TD 200 displays all values as decimal numbers. Various types of data are displayed in the following manner:

- Positive signed values are displayed without a sign.
- Negative signed values are displayed with a leading minus sign.
- Unsigned values are displayed without a sign.
- Values without non-zero digits to the left of the decimal point are displayed with a leading zero on the left side of the decimal point.
- Real (floating point) numbers are displayed with the number of decimal places that you specified (see Figure D-18). The value is rounded to the designated level of precision. For example, if one decimal place were specified for the value 12.567, the TD 200 would display "12.6".

The number of display characters that are used to display a value varies. This variation is not reflected in the number of bytes that are required to store the value in the S7-200 CPU memory. In the CPU memory, two bytes are required to store a word value, and four bytes are required to store a double word or a real (floating point) value.

Table D-1 shows you how many display characters are required for each display format and the maximum number of display characters required for each format. For example, if you know that the size of the value will never exceed three digits and will always be positive, then the number of display characters required will always be less than the maximum values given in Table D-1.

For real (floating point) numbers, the TD 200 uses up to 20 digits to represent the number. (This includes the number of decimal places that were specified in the format word. See Figure D-18.) If a number cannot be displayed within the number of digits available, the TD 200 displays “eeeeee” for that value.

Table D-1 Required Display Characters for Each Display Format

Value	Size	Number of Digits to the Right of the Decimal Point	Number of Display Characters (maximum)	Example
Unsigned	Word	0	5	12345
		1 to 4	6	1234.5 to 1.2345
		5	7	0.12345
		6	8	0.012345
		7	9	0.0012345
Signed	Word	0	6	-12345
		1 to 4	7	-1234.5 to -1.2345
		5	8	-0.12345
		6	9	-0.012345
		7	10	-0.0012345
Unsigned	DWord	0	10	1234567891
		1 to 7	11	123456789.1 to 123.4567891
Signed	DWord	0	11	-1234567891
		1 to 7	12	-123456789.1 to -123.4567891
Real (Floating Point)	DWord	0	Up to 20	-1234567
		1 to 7	Up to 20	12345.6 to 0.0123456

D.5 Understanding Message Types

Every message falls into one of four possible message acknowledgement and editing types. This section explains specifically how each message type is handled by the TD 200. The four message types follow:

- No acknowledgement required. No edits allowed.
- Acknowledgement required. No edits allowed.
- No acknowledgement required. Edits allowed.
- Acknowledgement required. Edits allowed.

No Acknowledgement, No Edits Allowed

In this combination of no acknowledgement required and no edits allowed, the TD 200 simply displays the message. The ENTER key has no function since there are no editable variables within the message. The message can contain variables that are updated at the update rate of the TD 200. This type of message is replaced on the display if a higher priority message is enabled by the S7-200 CPU. The operator can either press the UP or the DOWN arrow key to scroll through other messages or press ESC to return to the Menu mode.

The TD 200 does not clear the corresponding message-enable bit in the S7-200 CPU.

Acknowledgement, No Edits Allowed

In this combination of acknowledgement required and no edits allowed, the TD 200 displays the message and makes the entire message flash (blink) until the operator presses ENTER to acknowledge the message. Variable values are updated from the S7-200 CPU at the normal update rate while the message is flashing.

When the operator presses ENTER, the TD 200:

- Sets the acknowledgement-notification bit in the first format byte of the message.
- Clears the message-enable bit for this particular message. This causes the message to be removed from the display on the next update cycle.

Another message cannot replace the one flashing until the operator acknowledges the flashing message. This is also true even if a higher priority message is enabled in the S7-200 CPU. If the TD 200 is configured for 20-character messages and the CPU enables a higher priority message, the flashing message shifts to the second line of the display. The operator cannot press the UP or the DOWN key to scroll through other enabled messages until s/he acknowledges the current message.

No Acknowledgement, Edits Allowed

In this combination of no acknowledgement required and edits allowed, the TD 200 displays a message and then waits for the operator to edit it. All of the variables within the message are updated at the update rate. Since the message does not require acknowledgement, this type of message is removed from the TD 200 display if a higher priority message is enabled in the S7-200 CPU. An up or down arrow in the right-most character position indicates more messages. The operator can press either the UP or the DOWN arrow key to scroll through the other enabled messages.

For more information about editing variables, see Section D.6.

Acknowledgement, Edits Allowed

In this combination of acknowledgement required and edits allowed, the TD 200 displays the message, causes the entire message to flash (blink), and then waits until the operator acknowledges the message and edits the variables. This combination requires that the operator edit the variables. If the operator attempts to exit before editing all the variables in the message, the message flashes to indicate that edits are pending.

When the message is enabled in the S7-200 CPU, the TD 200 notes this and, if there is space available on the display, gets the message from the CPU. The TD 200 then displays the message and causes the entire message to flash to notify the operator that the message is present and must be acknowledged.

For more information about editing variables, see Section D.6.

D.6 Editing Variables with the TD 200

You can use the TD 200 to modify variables embedded in the messages. You can also configure a message to require that an operator acknowledge the message (see Section D.5). Messages that must be acknowledged flash when displayed on the TD 200. The operator uses the arrow keys and the ENTER key to acknowledge messages and to edit variables.

Note

Due to restrictions in the format used to store real (floating-point) numbers in both the S7-200 CPU and the TD 200, the accuracy of the number is limited to six significant digits. Editing a real number with more than six digits may not change the value of the variable, or may cause other digits within the number to change:

- Changing the least significant (right-most) digit of a real-number variable with more than six digits may have no effect. For example: if you try to change the "9" in "1234.56789", the value of the variable does not change.
 - Changing the most significant (left-most) digit of a real-number variable with more than six digits may cause other (less significant) digits in the variable to change.
-

Acknowledging and Editing a Message

Use the following procedure to edit a variable:

1. If the message does not require acknowledgement (is not flashing), select the message by pressing either the UP or the DOWN arrow key to place the cursor on the first character of the desired message.
2. Press ENTER to move the cursor to the least significant (right-most) character of the first editable variable.

For messages that require acknowledgement, pressing ENTER also sets the acknowledge-notification bit in the CPU and halts the flashing of the message on the display.

3. If the variable is password-protected, enter the 4-digit password at the prompt and press ENTER.
4. Press either the UP or the DOWN arrow key to increment or decrement the variable. (Pressing and holding either the UP or the DOWN key accelerates the increment or decrement operation.)
 - To move the cursor to the next digit position, press either the SHIFT UP (left) or the SHIFT DOWN (right) keys.
 - To reset the variable to 0, press the SHIFT ENTER keys.
5. Press ENTER to write the updated variable to the CPU.

On the same program scan, the edit-notification bit is set in the format word corresponding to the variable being edited.

If there are more editable variables in the message, the cursor moves to the next variable. After all of the variables in the message have been edited, the message-enable bit for the message is cleared in the CPU. The message is then removed from the display on the next update cycle.

If you do not edit the message variable, or if you abort the edit by pressing ESC, the message-enable bit is not cleared by the TD 200. The message-enable bit is cleared by the TD 200 only when you write the last editable variable to the CPU.

The UP and DOWN arrows that indicate higher and lower priority messages, if any are present, are disabled while an edit is in progress. These functions are restored when the edit is completed or aborted.

Aborting an Edit

You can abort an edit at any time by pressing ESC. This causes the TD 200 to reread the message from the CPU and to display the variables from the CPU. When the edit session is aborted, any values that have already been sent to the CPU (by pressing the ENTER key after modifying the value) are displayed; any value that was modified but not saved is overwritten by the previous (original) value.

When you abort an edit, the cursor returns to the left-most character of the message. (The message is not removed from the display until all of the edits are completed and written to the CPU.) If the message was configured for acknowledgement, the message starts to flash again, since the edit was not completed.

Note

An edit is automatically aborted if you do not press a key after one minute.

Index

A

Acknowledge message
not required, D-20, D-21
required, 2-16, D-20, D-21
Acknowledge-notification bit, D-13
Acknowledgement bit, D-12
Acknowledging messages, D-22–D-24
Address, network, setting, 3-16
Arrow keystrokes, recorded in the parameter block, D-5
ASCII character set, A-7
ASCII characters, TD 200 display, A-7

B

Bar graph character set, 2-4, 4-5, D-4
ALT key combinations, A-8
ASCII characters, A-7

C

Cable, TD/CPU, creating a pin-out, B-4
Clock, enabling, 2-5, D-5
Command keys, description, 1-3
Communication
multiple CPUs, 1-6, B-1
one-to-one, 1-6
Communication connections, 1-6
Configuration
messages, 2-7–2-11
multiple CPUs, B-1
one-to-one, 1-6
parameter block, D-4
Configuration Wizard, D-1
introduction, 2-2
CPU address, selecting, 3-17

D

Data size/format bits, D-17–D-20
Data value
acknowledge-notification bit, D-13
acknowledgement bit, D-12

data size/format bits, D-17–D-20
decimal (scaled) display, 2-12
decimal bits, D-17–D-20
edit-notification bit, D-14
editing, D-16
embedding in text messages, D-11
format word, D-11
real numbers, D-17–D-20

Date, setting, 3-13
Decimal bits, D-17–D-20
Defining messages, 2-9, D-9
Display message mode, 3-2
Display update rate, 2-5
selecting, 2-5
Displaying different messages, 3-18, D-2

E

Edit, aborting, 3-4
Edit allowed, messages, D-21
Edit not allowed, messages, D-20
Edit value bit, D-16
Edit-notification bit, D-14
Editing variables, 3-3–3-5, D-22–D-24
configuring password protection, 2-5, D-5
enabling a password, D-16
releasing the password, 3-15
storing a password, D-8
Embedded data, 2-16, D-11
dialog box, 2-12
Embedded data values (text messages), formatting, 2-12, D-11–D-19
Embedded variables, acknowledging and editing, 3-3–3-5, D-22–D-24
Error messages
fatal, 3-8
non-fatal, 3-8
viewing, 3-7

F

Floating point numbers. *See* Real numbers
Force function, 2-5
enabling, 2-5, D-5

- Force I/O menu, 3-9
 - accessing, 3-9
 - changing status, 3-12
 - correcting a password, 3-10
 - entering a password, 3-10
 - options, 3-11
 - Format word
 - data value, D-11
 - password protection, D-16
 - Function keys, 1-3
 - description, 1-3
 - enabling, 2-5
 - specifying memory bits, 2-5

 - H**
 - Hardware features, 1-2

 - I**
 - I/O
 - changing force status, 3-12
 - forcing/unforcing, 3-9, 3-12
 - Installation, TD 200, 1-4
 - International characters, A-8
 - ALT key combinations, A-8

 - K**
 - Keyboard, 1-3

 - L**
 - Ladder editor, 2-20, 4-4, 4-6
 - Language, operator interface, 2-4, D-4

 - M**
 - M area address, parameter block, 2-5, D-6
 - Manuals, iv
 - finding topics in manual set, iv
 - Menu language, 2-4
 - Menu mode, 3-5
 - force I/O, 3-9
 - release password, 3-15
 - set time and date, 3-13
 - Setup menu
 - baud rate, 3-19
 - CPU network address, 3-17
 - parameter (V memory) address, 3-18
 - TD 200 network address, 3-16
 - TD 200 Setup Menu, 3-16–3-20
 - viewing CPU status, 3-7
 - viewing messages, 3-6
- Message address, parameter block, D-7
 - Message enable address, parameter block, D-8
 - Message enable flags, 2-8
 - Message format
 - 20-character, D-9
 - 40-character, D-9
 - size, D-9
 - Messages, 2-7–2-11
 - acknowledge and edit, D-21
 - acknowledge, no edits, D-20
 - acknowledgement required, 2-16
 - acknowledgement required, edits allowed, D-21
 - creating, 2-9
 - data values in text, 2-10
 - defining, 2-9
 - embedded data, 2-16, D-11
 - embedding data values, 2-10, D-11
 - enable flags, 2-8, D-8
 - formatting embedded data value, 2-12, D-11
 - location, 2-8
 - no acknowledgement, edits allowed, D-21
 - no acknowledgement, no edits, D-20
 - number of, D-5
 - prioritizing, D-6
 - size/number, 2-7
 - text-only, 2-9
 - viewing, 3-6
 - viewing errors, 3-7
 - Mode of operation
 - display message, 3-2
 - menu, 3-5
 - Mounting, TD 200, 1-4
-
- N**
- Network address, setting, 3-16
- Number of messages, parameter block, D-5

O

- Operating mode
 - display message mode, 3-2
 - menu mode, 3-5

P

- Parameter block, D-2
 - 20-character message format, D-9
 - 40-character message format, D-9
 - address, 2-8
 - description, D-2
 - display mode configuration, D-5
 - Force function configuration, D-5
 - M area address, 2-5, D-6
 - message address, D-7
 - message enable address, D-8
 - message size, D-9
 - multiple, 3-18, D-2
 - number of messages, D-5
 - password protection, D-5
 - recording up/down arrows in, D-5
 - sample, 2-19
 - saving/viewing, 2-19
 - TD 200 configuration, D-4
 - TOD clock configuration, D-5
 - V memory location of, 3-18, D-2
- Password
 - correcting, 3-10
 - enabling password protection, 2-5
 - entering, 3-10
- Password protection, 2-5
 - configuring the parameter block, 2-5, D-5
 - enabling a password, D-16
 - releasing the password, 3-15
 - storing a password, D-8
- Pin-out, TD/CPU cable, B-4
- Power
 - external supply, 1-7
 - TD/CPU cable, 1-7
- Program, sample
 - generating a bar graph, 4-5
 - using text message to create a clock for CPU 214, 4-2

- Programmable logic controller. *See* S7-200 CPU

R

- Real numbers, D-17–D-20
 - editing variables in a message, 3-3, D-22
- Related manuals, iv
 - finding topics in manual set, iv

S

- S7-200 CPU, 1-1
- Scaled display of data, 2-12
- Set time and date menu, 3-13
- Special characters, A-8
 - ALT key combinations, A-8
- Statement List editor, 2-20, 4-6
- STEP 7–Micro/WIN, 2-2
 - TD 200 Configuration Wizard, 2-2, 4-2

T

- TD 200, defined, 1-1
- TD 200 Configuration Wizard
 - introduction, 2-2
 - starting, 2-2
- TD 200 Setup menu, 3-16–3-20
- TD/CPU cable, creating a pin-out, B-4
- Technische Daten, TD 200, A-4
- Text Display 200. *See* TD 200
- Time, setting, 3-13
- Time-of-Day (TOD) menu, enabling, 2-5
- Troubleshooting, TD 200, C-1

V

- V memory, storing different parameter blocks in, 3-18, D-2
- Variable data, editing, 3-3, D-22
- Variables, acknowledging and editing, 3-3–3-5, D-22–D-24
- Viewing CPU status menu, 3-7
- Viewing messages menu, 3-6

Siemens AG
A&D AS E 81

Oestliche Rheinbrueckenstr. 50
D-76181 Karlsruhe
Federal Republic of Germany

From:

Your Name: _____

Your Title: _____

Company Name: _____

Street: _____

City, Zip Code _____

Country: _____

Phone: _____

Please check any industry that applies to you:

- | | |
|--|---|
| <input type="checkbox"/> Automotive | <input type="checkbox"/> Pharmaceutical |
| <input type="checkbox"/> Chemical | <input type="checkbox"/> Plastic |
| <input type="checkbox"/> Electrical Machinery | <input type="checkbox"/> Pulp and Paper |
| <input type="checkbox"/> Food | <input type="checkbox"/> Textiles |
| <input type="checkbox"/> Instrument and Control | <input type="checkbox"/> Transportation |
| <input type="checkbox"/> Nonelectrical Machinery | <input type="checkbox"/> Other _____ |
| <input type="checkbox"/> Petrochemical | |



Remarks Form

Your comments and recommendations will help us to improve the quality and usefulness of our publications. Please take the first available opportunity to fill out this questionnaire and return it to Siemens.

Please give each of the following questions your own personal mark within the range from 1 (very good) to 5 (poor).

- 1. Do the contents meet your requirements?
- 2. Is the information you need easy to find?
- 3. Is the text easy to understand?
- 4. Does the level of technical detail meet your requirements?
- 5. Please rate the quality of the graphics/tables:

Additional comments:

